

CATALOGO GENERALE

GENERAL
CATALOGUE

01/2021



We Build the Invisible

colcomgroup.it

segui su [f](#) [▶](#) [t](#) [in](#)

webuildtheinvisible.com

segui su [f](#) [@](#) [▶](#) [in](#)

CATALOGO
GENERALE
GENERAL
CATALOGUE

www.colcomgroup.it



We Build the Invisible

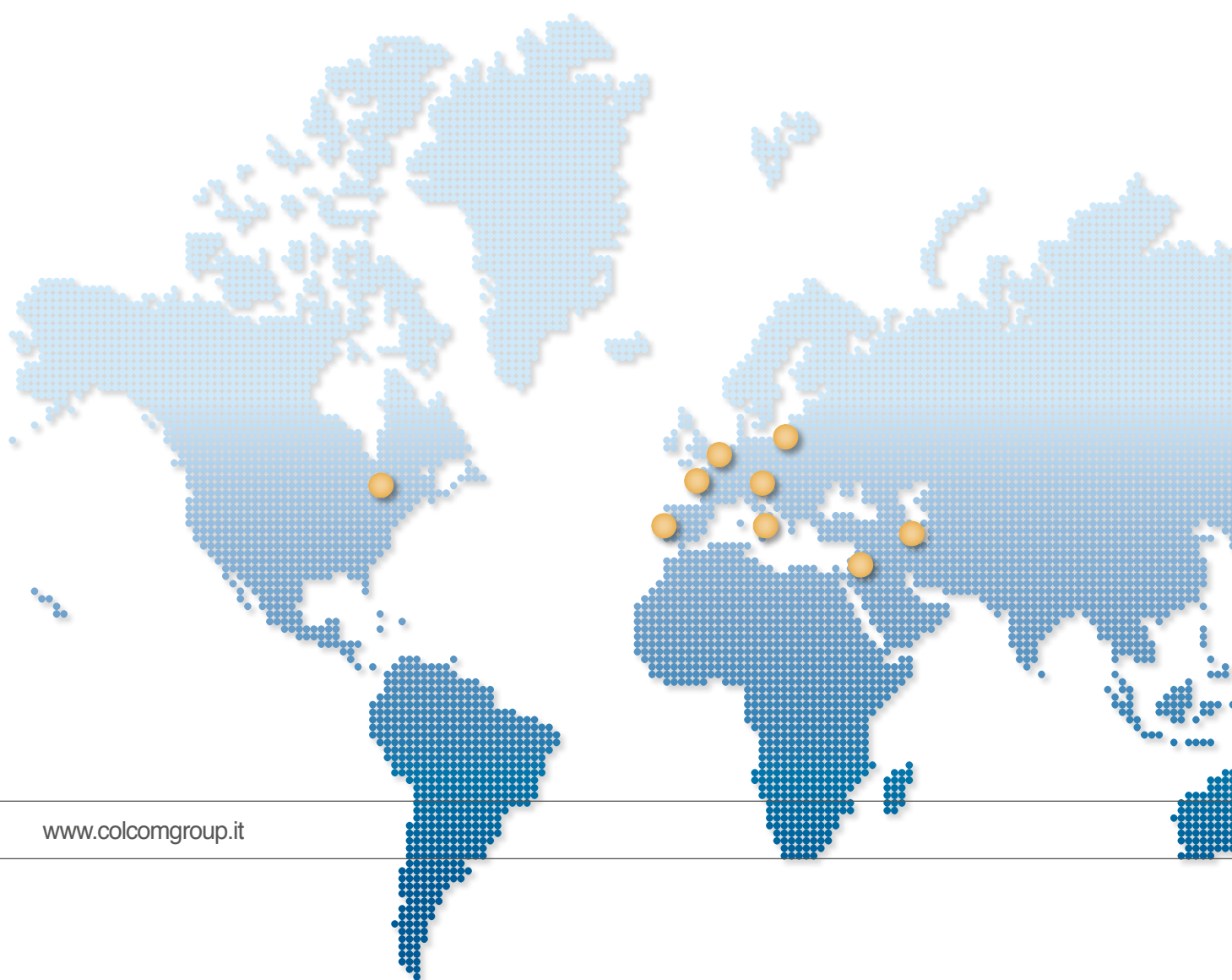

www.colcomgroup.it

Colcom Group è azienda leader che opera a livello mondiale tramite 8 società di cui 3 di produzione e 4 di distribuzione. Siamo presenti direttamente in diversi paesi del mondo: con filiali di proprietà in Spagna, Francia, Svizzera, Italia, India, Canada e con partecipate in Benelux e India.

Le aziende di produzione del gruppo sono Colcom, Sadev e Galvacom.

Colcom si occupa della produzione di accessori per vetro temperato e dello sviluppo tecnologico di nuove applicazioni OEM in codesign o design su incarico da parte delle industrie. Elemento di spicco della ricerca e sviluppo di Colcom Group è il concetto oleodinamico studiato e brevettato come evoluzione e sintesi delle cerniere automatiche-meccaniche e dei chiudiporta idraulici esistenti sul mercato. Questo è stato declinato in cerniere e sistemi che hanno reso possibile l'applicazione su porte interne, esterne e box doccia.

La francese **Sadev**, completa la gamma dei prodotti Colcom, aggiungendo una serie di applicazioni per esterno: fissaggi per vetri da esterno, facciate strutturali e balustrate. Gli Spiders e le Rotoules aprono un nuovo canale di vendita e di distribuzione costituito da una rete di general contractor e studi di architettura.

Galvacom si occupa di trattamenti galvanici di alta qualità e PVD, su ottone e alluminio. La cromatura dell'alluminio ne è il punto di forza da oltre 10 anni.

La distribuzione è affidata alle filiali **Minusco** che rappresentano la rete commerciale finalizzata alla vendita di accessori del vetro in tutto il mondo. Le filiali Minusco sono attive nel mercato globale e sono affiancate da una rete capillare di aziende partner.

La filiera progettuale, produttiva, distributiva e di assistenza tecnica sono magistralmente gestite dall'interno, in un rapporto di complementarità tra i vari reparti. Questo permette al gruppo di mettere in campo di volta in volta la migliore soluzione in risposta alle specifiche richieste del mercato.

Colcom Group is a leading firm, which works worldwide through 8 companies, among which 3 are production companies and 4 are distribution ones. We are directly present in different countries around the world: with owned branches in Spain, France, Switzerland, Italy, Canada and with shares in Benelux and India.

The production companies of the group are Colcom, Sadev and Galvacom.

Colcom deals with production of accessories for tempered glass and with technologic development of new OEM applications in co-design or design on the instruction by the industries. The leading element of Colcom Group's Research and Development is the oleodynamic concept, studied and patented as the evolution and union of automatic-mechanic hinges and hydraulic door closers present in the market. This concept has evolved into hinges and systems which made the application on inner doors, outer ones and shower cubicles. The French company **Sadev** completes the range of Colcom products, adding a series of external applications: external glass fittings, structural façades and balustrades. Spiders and swivel fittings open a new sales and distribution channel, constituted by a general contractor and architect studios' network.

Galvacom deal with high-quality galvanic treatments and PVD, upon brass and aluminium. Aluminium chromium plating has been its strong point for 10 years. Distribution relies on **Minusco** branches, which represent the commercial network, whose aim is to sell accessories for glass worldwide. The Minusco branches operate into the global market, and are sustained by a widespread network of partner companies.

Planning, production, distribution and technical assistance are expertly managed within the company, where the different departments are complementary to each other. This feature allows the group to deploy from time to time the best solution, responding to specific market needs.



We Build the Invisible

COLCOM

GALVACOM

SADDEV

La gamma colori / The colour range

Colcom offre un'ampia scelta di finiture tra cui scegliere, ognuna realizzata seguendo accuratamente ogni processo della produzione. Il processo PVD è possibile grazie all'utilizzo di nanotecnologie, e permette la produzione di rivestimenti estremamente sottili con particolari caratteristiche fisiche e meccaniche, a prova di corrosione e usura, ma soprattutto eco-efficienti.

Colcom offers a wide range of finishes, each realised following carefully every productive process. The PVD process is possible thanks to nanotechnologies, and allows the production of extremely thin coatings, with special physical and mechanical features, corrosion- and wearproof, but most of all ecologically efficient.

Finiture standard / Standard finish

			
02 Naturale Satin anodized	05 Nero Black	13 Simil inox satinato Imitation satin stainless steel	14 Cromato lucido Polished Chrome
			
15 Cromato opaco Matt Chrome	16 Oro lucido Imitation Polished Gold	17 Oro opaco Imitation Matt Gold	22 Naturale 20 micron Anodized 20 microni
			
31 Acciaio inox satinato Satin Stainless Steel	32 Acciaio inox lucido Polished Stainless Steel	34 Naturale lucido Sand Anodized <small>Solo per sistema Espro Only for ESPRO system</small>	47 Brillantato Fine-polishing finish
			
60 Verniciato liquido elettrostatico Liquid electrostatic coated	62 Verniciato liquido elettrostatico Liquid electrostatic coated		

* PVD Physical Vapour Deposition

Il PVD è un rivestimento metallico che assicura: ■ eccezionale resistenza all'abrasione ■ resistenza all'ossidazione ■ colorazioni innovative ed inalterabili nel tempo.
The PVD is a metal coating that ensures: ■ exceptional resistance to abrasion ■ resistance to oxidation ■ innovative and durable colouring.

- Soggetto a minimo di fatturazione e/o a diritto fisso €50 per piccoli lotti. Su richiesta. Chiedere a ufficio commerciale quotazione.
Subjected to minimum order and/or fixed fee of €50. Upon request. Please ask our sales dept. for a quotation.

Finiture speciali / Special finish

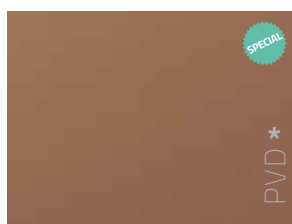

66 Bronzato lucido
Polished bright bronze

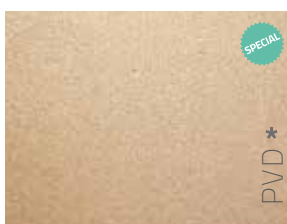

67 Bronzato opaco
Satin mat bronze



68 Champagne lucido
Polished bright champagne

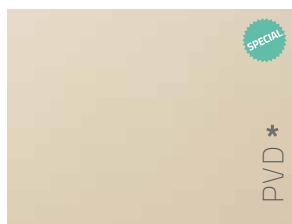

69 Champagne opaco
Satin mat champagne

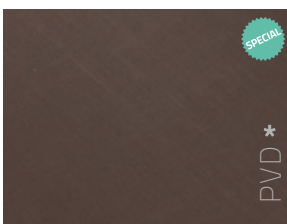

70 Nero canna di fucile lucido
Polished bright gunmetal grey

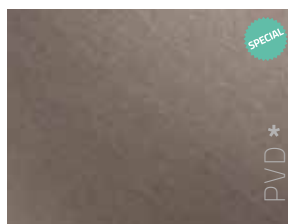

71 Nero canna di fucile opaco
Satin mat gunmetal grey



SPECIALI - SPECIAL

Contattare ufficio commerciale per lotti minimi, quotazione e tempi di consegna - Ask our sales dept for minimum order, for a quotation and delivery time

Guida alla scelta della finitura / Guide to choose the colors

Finiture / Colors	Interno / Inner						Esterno / Outer					
	Porte Doors			Box doccia Shower Boxes			Condizioni standard Standard environments			Condizioni particolari Special environments		
Materiale / Material	AL / ALU	OT / BRASS	ZAMAK	AL / ALU	OT / BRASS	ZAMAK	AL / ALU	OT / BRASS	ZAMAK	AL / ALU	OT / BRASS	ZAMAK
02	4			4			4			4		
05	4			4			4			4		
13	4	4	4	2	4	4	2	4	4			
14	4	5	4	3	5	4	3	5	4		5	4
15	4	5	4	3	5	4	3	5	4		5	4
16	4	4		2	4		2	4				
17	4	4		2	4		2	4				
22	5			5			5			5		
31	5			5			5			5		
32	5			5			5			5		
47	4			4			4			4		
60	5	5	5	5	5	5	5	5	5	5	5	5
62	5	5	5	5	5	5	5	5	5	5	5	5
66	4	4		2	4		2	4				
67	4	4		2	4		2	4				
68	4	4		2	4		2	4				
69	4	4		2	4		2	4				
70	4	4		2	4		2	4				
71	4	4		2	4		2	4				

• ATTENZIONE: Per installazioni in condizioni ambientali e climatiche particolari (es. umide, acide, saline), consultare prima l'ufficio commerciale - CAUTION: For installations in particular environments or climate (ex. wet, acid, saline) consult sales office first

Tutti i patch fitting con corpo in finitura "22" e copertine di acciaio inox hanno grado di resistenza pari a 5. In caso di copertine in alluminio la resistenza è indicata nella tabella sovrariportata - All patch fittings with body in "22" finish and stainless steel covers have a strength of 5. In the case of aluminum covers the resistance is indicated in the table above

Legenda / Legend

1 Bassa resistenza alla corrosione Low corrosion resistance	2 Moderata resistenza alla corrosione Moderate corrosion resistance	3 Alta resistenza alla corrosione High corrosion resistance	4 Resistenza molto alta alla corrosione Very high corrosion resistance	5 Resistenza eccellente alla corrosione Excellent corrosion resistance
---	---	--	--	--

Legenda simboli / Symbol legend



Sistema oleodinamico
Sistema hidráulico
Hydraulic system
Hydraulik Systeme
Hydraulique système



Regolazione del punto 0°
Ajuste del punto 0°
0° point adjustability
0° Punkt Regulierung
Régulation du point 0°



Prodotto certificato
Producto certificado
Certified product
Zertifizierten Produkt
Produit certifié



Prodotto brevettato
Producto patentado
Patented product
Patentierten Produkt
Produit breveté



Su richiesta: con minimo d'ordine
A petición: con mínimo de pedido
On request: with minimum quantity order
Auf Befragen: mit Mindestbestellmenge
Sur demande: minum de commande



Larghezza max porta
Anchura de la puerta
Max door width
Maximum Türbreite
Largeur maximale de la porte



Spessore del vetro
Espesor del vidrio
Glass thickness
Glasdicke
Épaisseur du verre



Peso massimo della porta
Peso max de la puerta
Max door weight
Maximum Türgewicht
Poids maximum de la porte



Spessore del legno
Espesor de madera
Wood thickness
Holzdicke
Épaisseur du bois



Angolo di chiusura automatica
Esquina de cerramiento automática
Automatic closing angle
Automatischer Schliessungswinkel
Angle de fermeture automatique

Coppie di serraggio viti consigliate
Tightening torque for suggested screws

	DIMENSIONE VITE SCREW DIMENSION (Passo grosso - Coarse pitch)	COPPIA DI SERRAGGIO TIGHTENING TORQUE Nm
	M4	3
M5	6	
M6	10	

DIN 107 Come determinare la mano dei nostri articoli / How to determine the hand of our articles

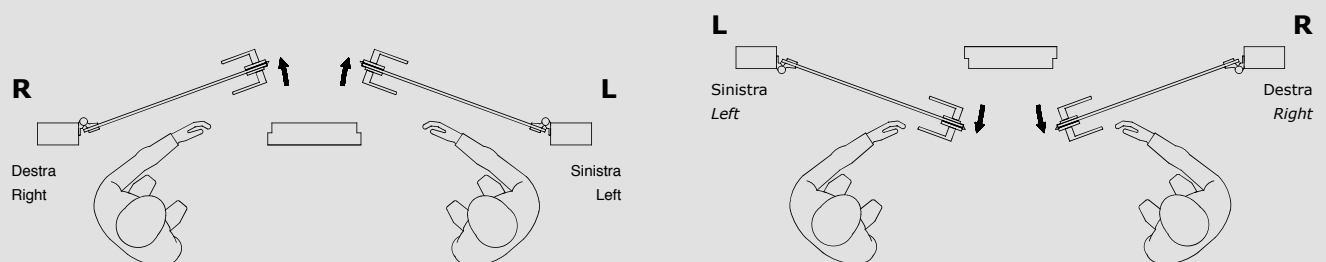

Indice / Index

09
Box Doccia
Box Ducha
Shower Boxes
Duschkabine
Cabines de Douche

137
Porte Interne
Puertas Internas
Inner Doors
Innentüren
Portes intérieures

197
Porte Interne in Legno
Puertas Internas en Madera
Inner Wooden Doors
Innentüren aus Holz
Portes intérieures en Bois

213
Partizioni e Sistemi profili
Particiones y Perfiles sistemas
Partitioning and Profile system
Glasverbinder und Profilsysteme
Renvois d'angles et Systèmes profilés

281
Porte Scorrevoli
Puertas Correderas
Sliding Doors
Schiebetürsysteme
Portes Coulissantes

395
Porte Esterne
Puertas Exteriores
Outer Doors
Aussentüren
Portes extérieures

437
Serrature e Maniglioni
Cerraduras y Tiradores
Locks and Handles
Schlüssel und Türstoßgriffe
Serrures et Poignées

503
Vetrine e Reggimensola
Escapartes y Soporta Estante
Cabinets and Shelf Brackets
Vitrinen- und Regalbefestigungen
Vitrines et Étagères

509
Arredo Urbano
Mobiliario Urbano
Urban Glass Fittings
Stadtausstattung
Architecture Urbaine

511
Filiali e distributori
Sucursales y distribuidores
Branches & Distributors
Niederlassungen und Händler
Succursales et distributeurs



BOX DOCCIA

Box Ducha
Shower Boxes
Duschkabine
Cabine de Douche

cerniere oleodinamiche / oildynamic hinges

Bilobina Centrale



825E00



825E10



825E50



Zama / Zamak - finiture / colors 13-14-15 (art.825E00 solo finitura/only color 14)

Cerniera oleodinamica per box doccia che permette l'apertura della porta sia verso l'interno che verso l'esterno (double-way). Ha all'interno un cuore oleodinamico unico per funzionalità, che rende questa cerniera un chiudiporta a tutti gli effetti con la caratteristica chiusura automatica, dolce e controllata dell'angola. Bilobina centrale ha la possibilità di regolare il punto zero di $\pm 3^\circ$. È disponibile nella versione vetro-vetro e vetro-muro, quest'ultima prevede anche la versione con piastrina spostata. È coperta da brevetto internazionale ed ha superato i più severi test di corrosione in AASS.

Bisagra hidráulica para cabinas de ducha permite la abertura de la puerta tanto hacia el interior como hacia el exterior (vaivén). Por dentro tiene un núcleo hidráulico, único por su funcionalidad, que convierte esta bisagra en un verdadero cierrapuerta con el típico cierre automático, dulce y controlado del batiente. Con Bilobina centrale puedes ajustar el punto cero de $\pm 3^\circ$. Disponible tanto en la versión vidrio-vidrio como en la vidrio-muro. Esta última admite la versión con plaqueta desplazada también. Es cubierta por una patente internacional y ha pasado los test de corrosión AASS más estrictos.

Hydraulic hinge for shower boxes allows the door to open both inwards and outwards (double -way). It has a hydraulic mechanism which makes it, in fact, a door closer with its characteristic automatic and control-

led closing. With Bilobina Centrale you can adjust the zero point up to $\pm 3^\circ$. Available glass-glass and glass-wall versions, the latter one also includes the offset mounting plate. Covered by international patent and passed the most severe corrosion tests in AASS.

Diese Version ermöglicht es, dass die Tür in beide Richtungen, Einwärts und Auswärts geöffnet wird (Pendeltür). Das Band hat einen hydraulischen Mechanismus, der es mit einem Türschließer hinsichtlich der Eigenschaften, automatische und kontrollierte Schließung gleichsetzt. Mit Bilobina Centrale lässt sich die Nulllage um $\pm 3^\circ$ regulieren. Verfügbar in Glas-Glas und Glas-Wand Ausführung, letztere auch mit einseitiger Anschraubplatte. Geschützt mit internationalem Patent und Korrosionseigenschaften erfolgreich geprüft nach den harten Bedingungen der Essigsäure-Salzsprühtests (AASS).

Charnière hydraulique pour cabine de douche qui permet une ouverture de la porte à la fois vers l'intérieur et vers l'extérieur (double-sens). Elle possède un mécanisme hydraulique interne unique, ce qui en fait, en réalité, un ferme-porte avec fermeture automatique, douce et contrôlée. Le point zéro de la Bilobina centrale peut être ajusté jusqu'à $\pm 3^\circ$. Elle est disponible dans les versions verre-verre et verre-mur, cette dernière incluant également une plaque de montage déportée. Elle est couverte par un brevet international et a passé les tests de corrosions les plus rigoureux en AASS.





825E00

Bilobina®

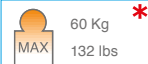

- Cerniera idraulica vetro-muro con automatismo di chiusura integrato. Stop a 0° +90° -90°. Regolazione allineamento 0° ±3°.
- Bisagra oleodinámica vidrio-muro con automatismo de cierre integrado. Stop 0° +90° - 90°. Regulación de ajuste 0° ±3°.
- Glass-wall hydraulic hinge with integrated closing automatism. Stop at 0° + 90° -90°. Alignment adjustable to 0° ±3°.
- Hydraulikband Glas/Wand mit integriertem Türschließer. Stop 0° +90° - 90°. Richtungsregler 0° ±3°.
- Charnière hydraulique verre-mur avec système de fermeture automatique intégré. Arrêt à 0°, + 90° et -90°. Alignement réglable de 0° jusqu'à + 3°.

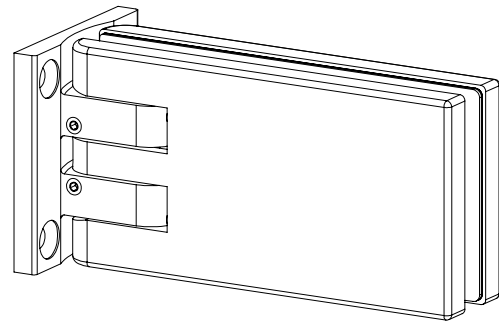

* Per porte con peso superiore ai 50 kg e di larghezza oltre 800 mm si consiglia l'utilizzo di n° 3 cerniere • Para puertas con un peso superior a los 50 kg y con más de 800 mm de ancho se aconseja utilizar 3 bisagras • For doors with weight higher than 50 Kgs and largeness higher than 800 mm we suggest to use 3 hinges • Für Türe mit größerem Gewicht als 50 Kgs und größerer Breite als 800 mm schlagen wir die Verwendung von 3 Beschlägen vor • Dans le cas d'une utilisation pour une porte dont le poids est supérieur à 50 kg et la hauteur supérieure à 800 mm, nous vous suggérons l'utilisation de 3 charnières

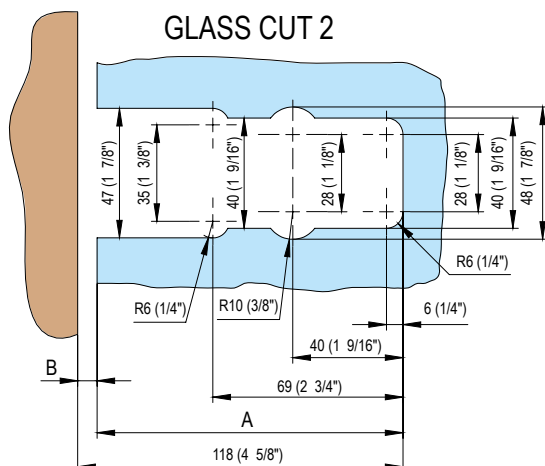
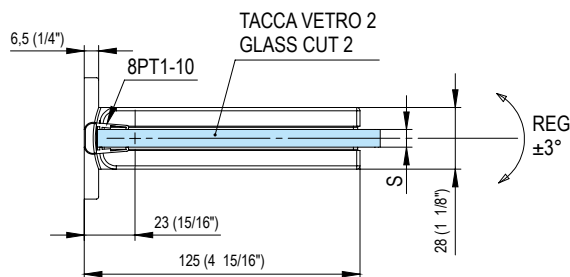
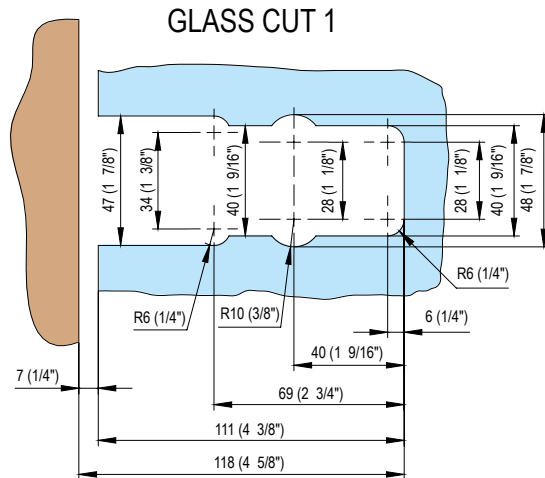
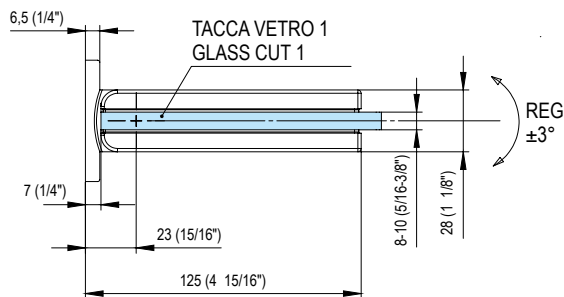
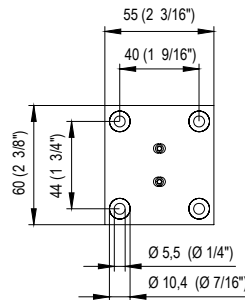
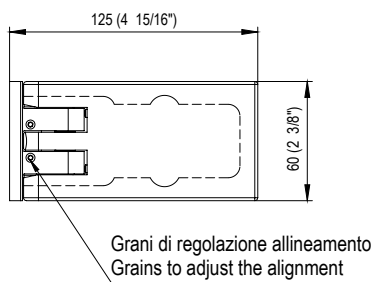

S	A	B
8 (5/16")	112 (4 13/32")	6 (1/32")
10 (3/8")	110 (4 11/32")	8 (5/16")

825E10

Bilobina®

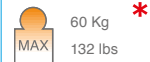
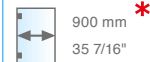

- Cerniera idraulica vetro-muro con automatismo di chiusura integrato. Aletta spostata. Stop a 0° +90° -90°. Regolazione allineamento 0° ±3°.
- Bisagra oleodinámica vidrio-muro con automatismo de cierre integrado. Aleta desplazada. Stop 0° +90° - 90°. Regulación de ajuste 0° ±3°.
- Glass-wall hydraulic hinge with integrated closing automatism. Off-set wing. Stop at 0° + 90° -90°. Alignment adjustable to 0° ±3°.
- Hydraulikband Glas/Wand mit integriertem Türschließer Verschiebenflosse. Stop 0° +90° - 90°. Richtungsregelierung 0° ±3°.
- Charnière hydraulique verre-mur, à enclage non symétrique, avec système de fermeture automatique intégré. Arrêt à 0°+ 90° -90°. Alignement réglable de 0° jusqu'à + 3°.

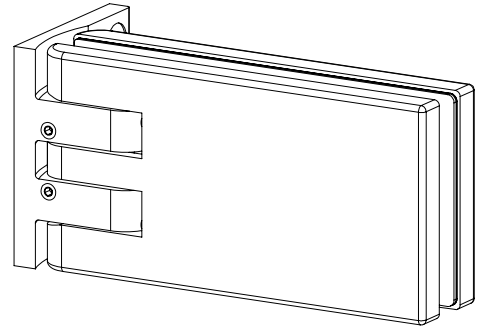

* Per porte con peso superiore ai 50 kg e di larghezza oltre 800 mm si consiglia l'utilizzo di n° 3 cerniere • Para puertas con un peso superior a los 50 Kgs y con más de 800 mm de ancho se aconseja utilizar 3 bisagras • For doors with weight higher than 50 Kgs and largeness higher than 800 mm we suggest to use 3 hinges • Für Türe mit größerem Gewicht als 50 Kgs und größerer Breite als 800 mm schlagen wir die Verwendung von 3 Beschlägen vor • Dans le cas d'une utilisation pour une porte dont le poids est supérieur à 50 kg et la hauteur supérieure à 800 mm, nous vous suggérons l'utilisation de 3 charnières

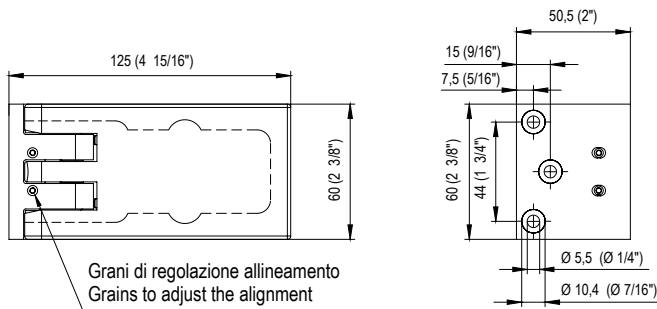

Grani di regolazione allineamento
Grains to adjust the alignment

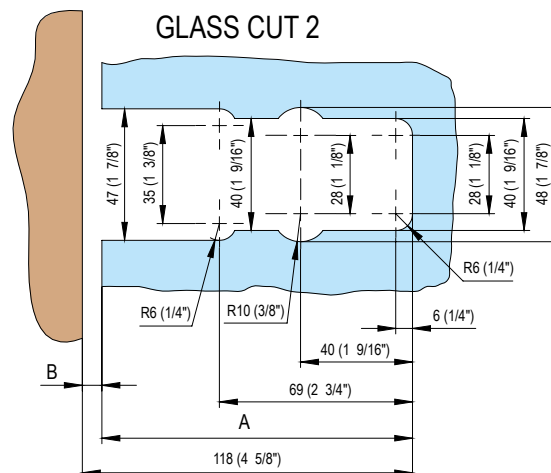
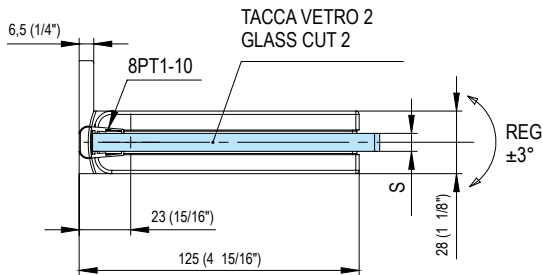
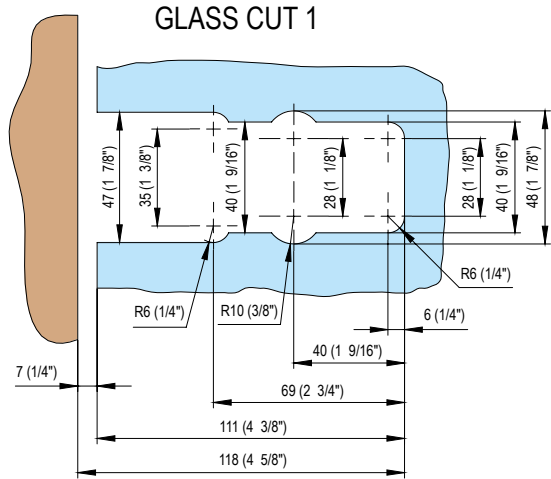
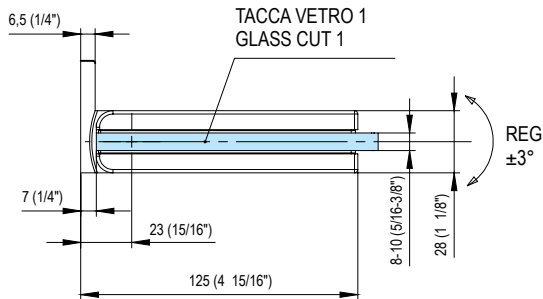

S	A	B
8 (5/16")	112 (4 13/32")	6 (1/32")
10 (3/8")	110 (4 11/32")	8 (5/16")

825E50

Bilobina®

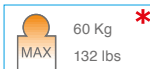
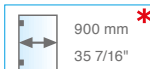
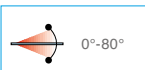

- Cerniera idraulica Vetro-Vetro con automatismo di chiusura integrato. Stop a 0° +90° -90°. Regolazione allineamento 0° ±3°.
- Bisagra oleodinámica vidrio-vidrio con automatismo de cierre integrado. Aleta desplazada. Stop 0° +90° - 90°. Regulación de ajuste 0° ±3°.
- Hydraulic glass-glass hinge with integrated closing automatism. Off-set wing. Stop at 0° + 90° -90°. Alignment adjustable to 0° ±3°.
- Hydraulikband Glas/Glas mit integriertem Türschließer Verschiebenflosse. Stop 0° +90° - 90°. Richtungsregelierung 0° ±3°.
- Charnière hydraulique verre-verre, à enclage non symétrique, avec système de fermeture automatique intégré. Arrêt à 0° + 90° -90°. Alignement réglable de 0° jusqu'à +3°.

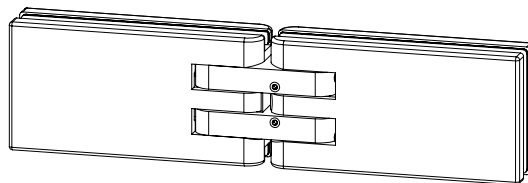

* Per porte con peso superiore ai 50 kg e di larghezza oltre 800 mm si consiglia l'utilizzo di n° 3 cerniere • Para puertas con un peso superior a los 50 Kgs y con más de 800 mm de ancho se aconseja utilizar 3 bisagras • For doors with weight higher than 50 Kgs and largeness higher than 800 mm we suggest to use 3 hinges • Für Türe mit größerem Gewicht als 50 Kgs und größerer Breite als 800 mm schlagen wir die Verwendung von 3 Beschlägen vor • Dans le cas d'une utilisation pour une porte dont le poids est supérieur à 50 kg et la hauteur supérieure à 800 mm, nous vous suggérons l'utilisation de 3 charnières

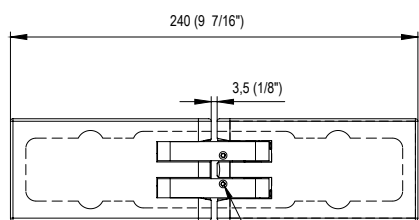

Grani di regolazione allineamento
Grains to adjust the alignment

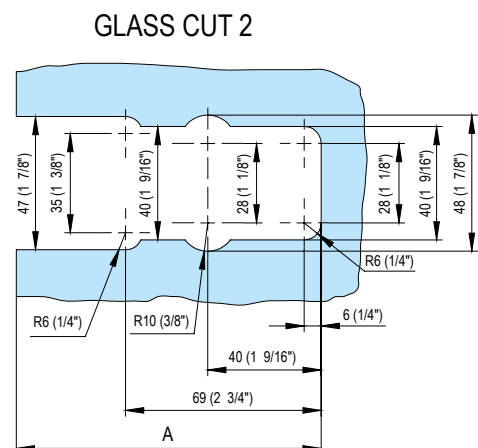
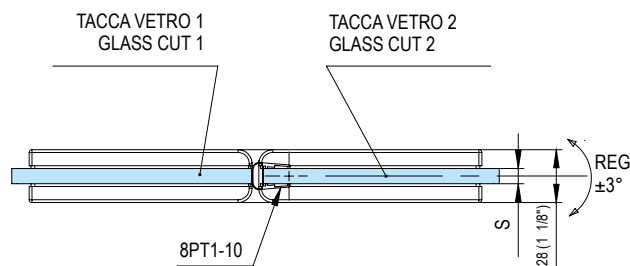
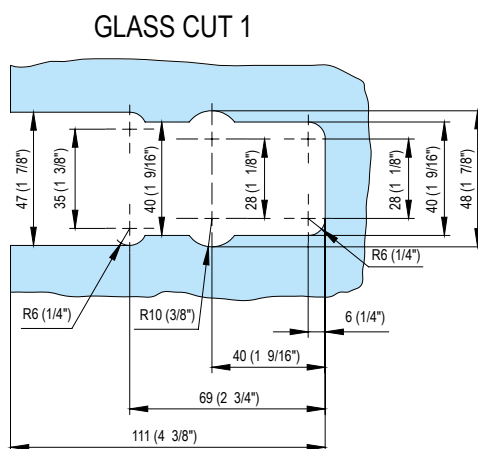
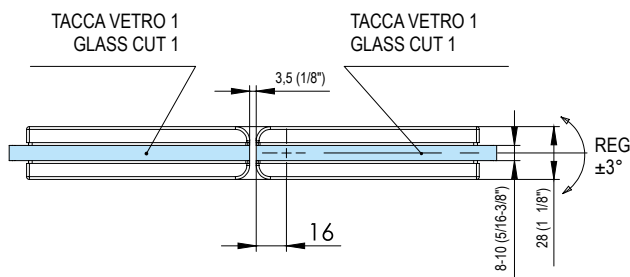
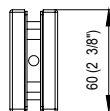

S	A
8 (5/16")	108.5 (4 9/32")
10 (3/8")	106.5 (4 3/16")

cerniere oleodinamiche / oildynamic hinges

Bilobina



815E10N



815E50N



Zama / Zamak - finiture / colors 14-60-62

Cerniera oleodinamica per box doccia. Il design semplice e compatto racchiude al suo interno l'automatismo di chiusura tipico della serie oleodinamiche di Colcom. L'anta si chiude da sé in modo dolce e controllato, garantendo massima funzionalità e sicurezza.

Bisagra hidráulica para mampara de baño. El diseño simple y compacto contiene en su interior el mecanismo de cierre típico de las bisagras hidráulicas de Colcom. La puerta se cierra de manera suave y controlada, garantizando la máxima funcionalidad y seguridad.

Hydraulic hinge for shower enclosure. The simple and compact design includes the closing automatism which is typical of Colcom hydraulic

series. The door closes automatically in a smooth and controlled way, and it grants absolute performance and safety.

Hydraulikscharnier für Duschen. Das schlichte und schlanke Design beinhaltet das Schließmechanismus typisch aller Colcom Hydraulikscharniere. Die Tür schließt automatisch mit kontrollierter und leiser Bewegung zu, das garantiert absolute Leistung und Sicherheit.

Charnière hydraulique pour cabine de douche. Le design, simple et compact, comprend l'automatisme de fermeture, caractéristique de la série hydraulique Colcom. La porte se referme d'elle-même, de manière douce et contrôlé





815E10N Bilobina®

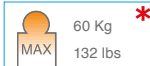
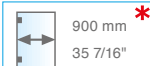

• È necessaria una battuta in chiusura in quanto la cerniera ha una precarica.
 • Necesita de un cierre con tope, puesto que la bisagra tiene una precarga.
 • The hinge has a loading and it is therefore necessary a closing stop.
 • Eine Schließfeststellung ist notwendig, weil das Scharnier eine mechanische Belastung hat.
 • La charnière a une charge, il est donc nécessaire d'avoir un arrêt de fermeture.

• Cerniera idraulica vetro-muro in battuta, con automatismo di chiusura integrato. Stop a +90°. Chiusura ermetica.

• Bisagra hidráulica vidrio-pared para puerta con tope, integrada de automatismo de cierre. Stop a +90°. Sello hermético.

• Hydraulic hinge glass-wall with stop and integrated closing automatism. Stop at +90°. Hermetic closing.

• Hydraulikscharnier Glas-Wand mit Anschlag und integriertem, automatischem Schließmechanismus. Feststellung bei +90°. Hermetische Schließung.

• Charnière hydraulique mur-verre pour cabines de douche avec système de fermeture automatique. Arrêt à +90°. Fermeture hermétique.

S	A	B	Profilo - Seal
6	7	37	8PT8-10
8 (5/16")	9 (11/32")	35 (1 3/8")	8PT8-10
10 (3/8")	8 (5/16")	36 (1 13/32")	8PT1-10

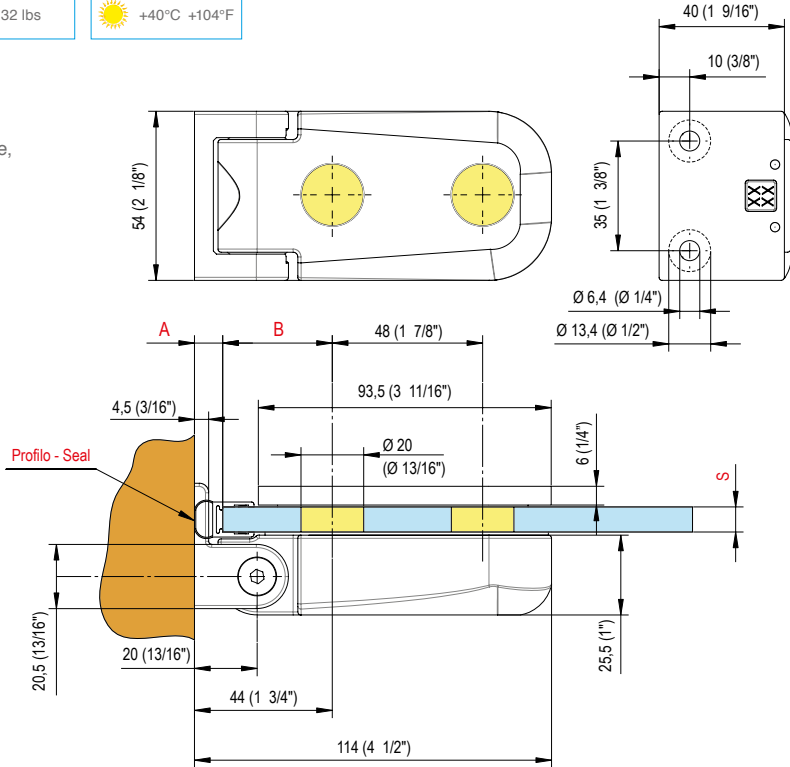
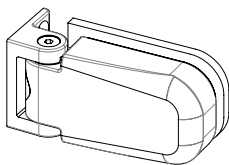

* Per porte con peso superiore ai 50 kg e di larghezza oltre 800 mm si consiglia l'utilizzo di n° 3 cerniere • Para puertas con un peso superior a los 50 kg y con más de 800 mm de ancho se aconseja utilizar 3 bisagras • For doors with weight higher than 50 Kgs and largeness higher than 800 mm we suggest to use 3 hinges • Für Türe mit größerem Gewicht als 50 Kgs und größerer Breite als 800 mm schlagen wir die Verwendung von 3 Beschlägen vor • Dans le cas d'une utilisation pour une porte dont le poids est supérieur à 50 kg et la hauteur supérieure à 800 mm, nous vous suggérons l'utilisation de 3 charnières

815E50N Bilobina®

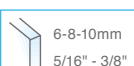
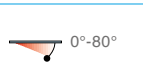

• È necessaria una battuta in chiusura in quanto la cerniera ha una precarica.
 • Necesita de un cierre con tope, puesto que la bisagra tiene una precarga.
 • The hinge has a loading and it is therefore necessary a closing stop.
 • Eine Schließfeststellung ist notwendig, weil das Scharnier eine mechanische Belastung hat.
 • La charnière a une charge, il est donc nécessaire d'avoir un arrêt de fermeture.

• Cerniera idraulica vetro-vetro in battuta, con automatismo di chiusura integrato. Stop a +90°. Chiusura ermetica.

• Bisagra hidráulica vidrio-vidrio para puerta con tope, integrada de automatismo de cierre. Stop a +90°. Sello hermético.

• Hydraulic hinge glass-glass with stop and integrated closing automatism. Stop at +90°. Hermetic closing.

• Hydraulikscharnier Glas-Glas mit Anschlag und integriertem, automatischem Schließmechanismus. Feststellung bei +90°. Hermetische Schließung.

• Charnière hydraulique verre-verre avec système de fermeture automatique. Arrêt à +90°. Fermeture hermétique.

S	A	B	Profilo - Seal
6	3.5	38.5	8PT8-30
8 (5/16")	5.5 (7/32")	37.5 (1 15/32")	8PT8-30
10 (3/8")	3.5 (1/8")	38.5 (1 17/32")	8PT1-30

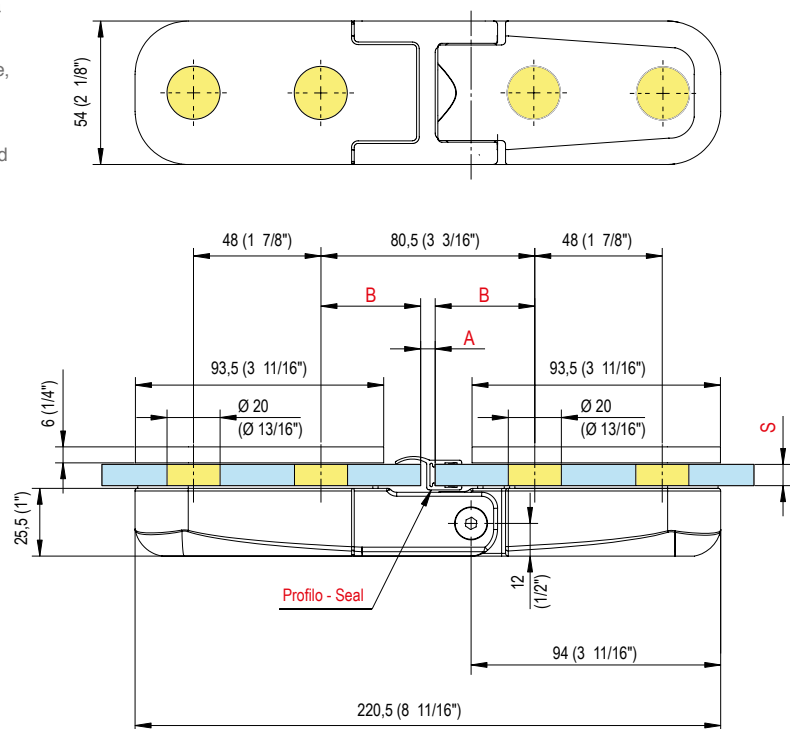
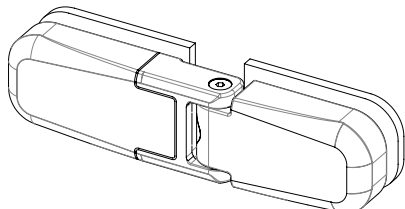

cerniere oleodinamiche / oildynamic hinges

Biloba BT



8010BT



8011BT



8015BT



8060BT



Alluminio / Aluminium - finiture / colors 05-13-14-15-16-17-22-60-62

Cerniere oleodinamiche nate per l'applicazione in ambienti umidi come box doccia, saune e bagni turchi. Dotate di tutte le caratteristiche che contraddistinguono l'intera gamma Biloba, le cerniere della serie BT montano un perno in acciaio INOX AISI 420 e guarnizioni OR in Viton. Supportano pertanto temperature fino a 100°. **Finitura testata, garantita e quindi consigliata è la "22" (ossidazione profonda 20 micron).**

Bisagras hidráulicas por el uso en ambientes húmedos tales como ducha, sauna y baño turco. Tienen todas las características que distinguen a la gama de "Biloba"; la serie BT monta eje de acero inoxidable AISI 420 y OR en Vitón. Por lo tanto, soportan temperatura hasta 100°C. **Acabado garantizado; se recomienda el "22" (oxidación profunda 20 micrones).**

Hydraulic hinges born for application in wet areas such as showers, saunas and steam baths. Equipped with features characterizing the full Biloba range, the BT series mount the pin in INOX AISI 420 stainless steel and Viton OR-rings. Therefore they resist to temperatures up to

100°C. **The tested, guaranteed and therefore recommended finishing is „22“ (deep oxidation 20 microns).**

Hydraulische Scharniere für den Einsatz in Nassbereichen wie Duschen, Saunen und Dampfbädern. Ausgestattet mit allen Charakterisierungen der gesamten Biloba Palette, die Scharniere der BT Serie montieren den Stift aus Edelstahl AISI 420 und Viton-OR-Dichtungsringe. Deshalb vertragen sie Temperaturen bis zu 100°C. **Die getestete, garantierte und daher empfohlene Feinbearbeitung ist „22“ (tiefe Oxidation 20 Mikron).**

Charnières hydrauliques conçues pour une application dans des milieux humides tels que les douches, saunas et hammams. Équipées de toutes les fonctionnalités qui caractérisent la gamme Biloba, les charnières de la série BT ont une goupille en acier inoxydable AISI 420 et des joints en Viton. Par conséquent, elles supportent des températures allant jusqu'à 100°. **La finition testée, garantie et donc recommandée est la "22" (oxydation de 20 microns de profondeur).**





8010BT

BILOBA®



• Cerniera oleodinamica con regolazione delle velocità di chiusura dell'anta **specifica per applicazioni in ambienti umidi anche con alte temperature come saune e bagni turchi**. Monta tutte le guarnizioni OR del circuito oleodinamico in Viton e perno in acciaio inox AISI 420. Stop a 0° +90° -90°.

• Bisagra hidráulica con ajuste de la velocidad de cierre de la puerta; **nacida por ambientes húmedos y aplicaciones también con altas temperaturas - como sauna y baño turco**. Reúne todos los herrajes OR del circuito hidráulico en Viton y perno en acero inox 420 AISI. Freno en 0° + 90° -90°.

• Hydraulic hinge with adjustment of the closing speed, **conceived for applications in damp environments and also high temperature like saunas and Turkish baths**. The o-rings of the hydraulic circuit are made of Viton and the pivot is made of stainless steel AISI 420. Stop at 0° +90° -90°.

• Hydraulkscharnier mit Feststellung der Türschließgeschwindigkeit der Tür, **konzipiert für Anwendungen in feuchten Milieus und auch hohen Temperaturen wie Saunas und Türkische Bäder**. Die O-Ring Dichtungen des hydraulischen Kreises sind aus Viton und der Spindel ist aus Edelstahl AISI 420. Feststellung bei 0° +90° -90°.

• Charnière hydraulique avec réglage de la vitesse de fermeture, **conçue pour des applications en milieu humide et/ou avec des températures élevées comme les saunas et hammams**. Les bagues du circuit hydraulique sont en caoutchouc et le système pivotant en inox AISI 420. Arrêt à 0°, +90° et -90°.

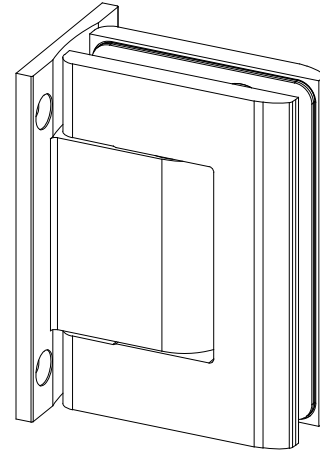

ATTENZIONE - PRECAUCIÓN - CAUTION - ACHTUNG - ATTENTION

APERTURE VIOLENTE OLTRE I 95° POTREBBERO CAUSARE LO SCARDINAMENTO. È CONSIGLIABILE L'APPLICAZIONE DI UN FERMAPORTA - APERTURA VIOLENTE ADEMÁS DE 95°, PODRÍA CAUSAR DAÑO. ACONSEJAMOS UTILIZAR UN FIJA PUERTA. - VIOLENT OPENING FURTHER THAN 95° COULD UNHINGE THE DOOR. WE SUGGEST TO INSTALL A DOOR STOP - HEFTIGE ÖFFNUNGEN MEHR ALS 95° KÖNNTEN DIE TÜR AUSHEBEN. WIR SCHLAGEN DIE INSTALLIERUNG EINES TÜRHALTERS VOR - UNE OUVERTURE VIOLENTE AU-DELÀ DE 90° PEUT DEGONDER LA PORTE. IL EST RECOMMANDÉ D'UTILISER UN FERME-PORTE

La finitura consigliata e garantita per applicazioni box doccia , sauna e bagno turco è la „22“ (deep oxy 20 micron) - Acabado "22" (deep oxy 20 micron): garantizado y recomendado para box ducha, sauna y baño de vapor - The recommended and guaranteed finish for applications in shower enclosures, saunas and Turkish baths is 22 (Deep Oxidation 20 micron) - Die vorgeschlagene und garantierte Oberfläche für Anwendungen in Duschen, Saunas und Türkische Bäder ist die 22 (tiefe Oxidation 20 Mikron) - La finition recommandée pour les applications telles que les douches, saunas et hammams est la n°22 (anodisation naturelle 20 microns)

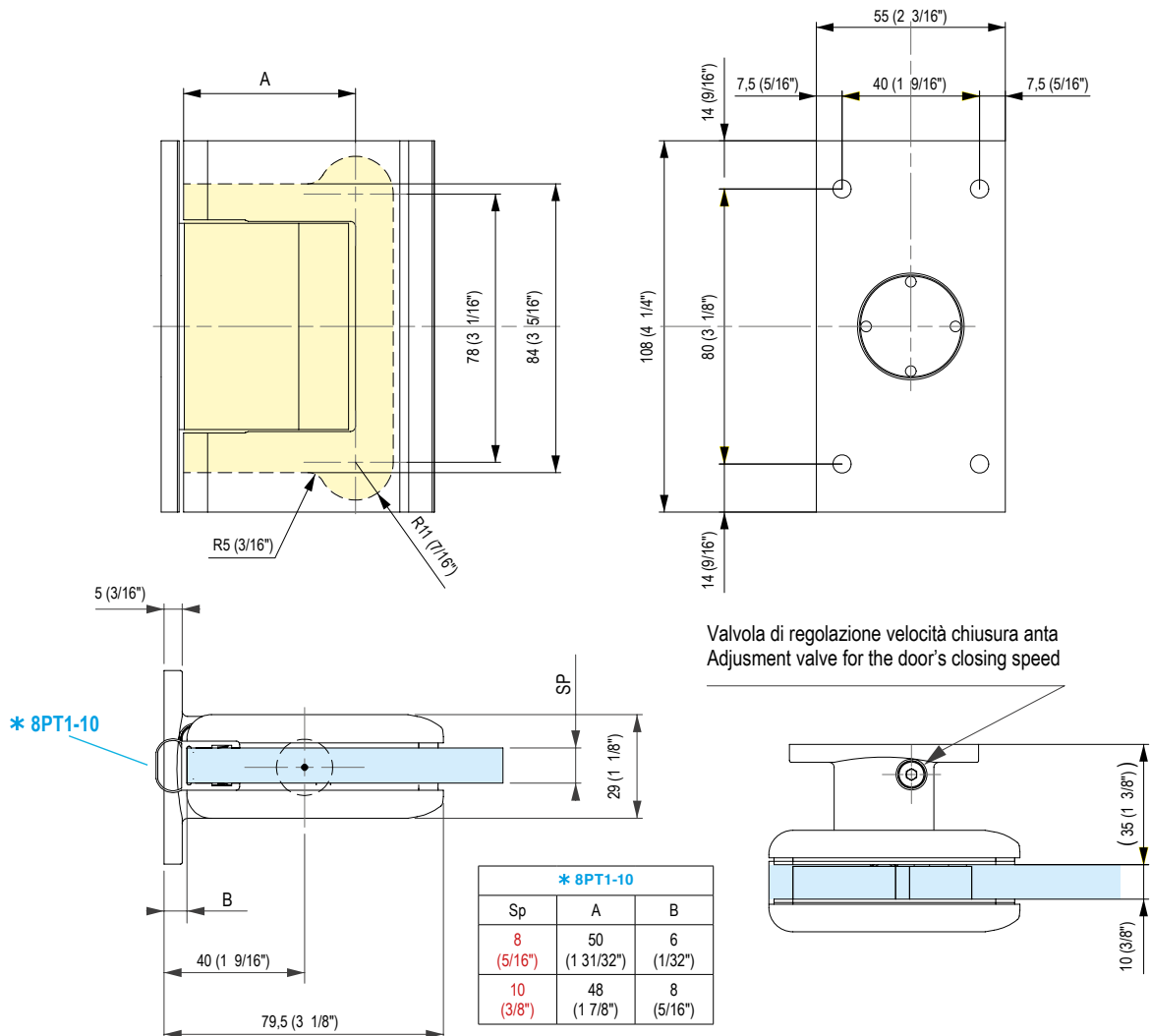

8011BT

BILOBA®

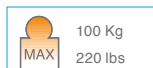
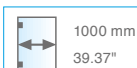
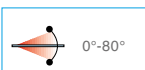

• Cerniera oleodinamica (aletta spostata) con regolazione delle velocità di chiusura dell'anta **specifica per applicazioni in ambienti umidi anche con alte temperature come saune e bagni turchi**. Monta tutte le guarnizioni OR del circuito oleodinamico in Viton e perno in acciaio inox AISI 420. Stop a 0° +90° -90°.

• Bisagra hidráulica (con aleta desplazada) con ajuste de la velocidad de cierre de la puerta; **nacida por ambientes húmedos y aplicaciones también con altas temperaturas - como sauna y baño turco**. Reúne todos los herrajes OR del circuito hidráulico en Viton y perno en acero inox 420 AISI. Freno en 0° +90° -90°.

• Hydraulic hinge (with offset fixing wing) with adjustment of the closing speed, **conceived for applications in damp environments and also high temperature like saunas and Turkish baths**. The o-rings of the hydraulic circuit are made of Viton and the pivot is made of stainless steel AISI 420. Stop at 0° +90°-90°.

• Hydraulikscharnier (Rippe seitlich angeschlagen) mit Feststellung der Türschließgeschwindigkeit, **konzipiert für Anwendungen in feuchten Milieus und auch hohen Temperaturen wie Saunas und Türkische Bäder**. Die O-Ring Dichtungen des hydraulischen Kreises sind aus Viton und der Spindel ist aus Edelstahl AISI 420. Feststellung bei 0° +90° -90°.

• Charnière hydraulique avec réglage de la vitesse de fermeture, **conçue pour des applications en milieu humide et/ou avec des températures élevées comme les saunas et hammams**. Les bagues du circuit hydraulique sont en caoutchouc et le système pivotant en inox AISI 420. Arrêt à 0°, +90° et -90°.

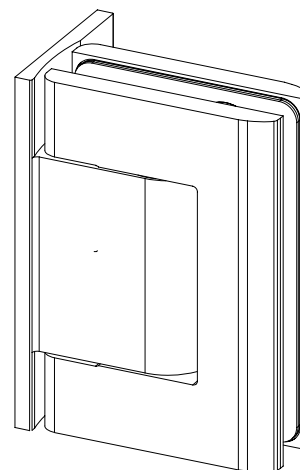

ATTENZIONE - PRECAUCIÓN - CAUTION - ACHTUNG - ATTENTION

APERTURE VIOLENTE OLTRE I 95° POTREBBERO CAUSARE LO SCARDINAMENTO. È CONSIGLIABILE L'APPLICAZIONE DI UN FERMAPORTA - APERTURA VIOLENTE ADEMÁS DE 95°, PODRIA CAUSAR DAÑO. ACONSEJAMOS UTILIZAR UN FIJA PUERTA. - VIOLENT OPENING FURTHER THAN 95° COULD UNHINGE THE DOOR. WE SUGGEST TO INSTALL A DOOR STOP - HEFTIGE ÖFFNUNGEN MEHR ALS 95° KÖNNTEN DIE TÜR AUSHEBEN. WIR SCHLAGEN DIE INSTALLIERUNG EINES TÜRHALTERS VOR - UNE OUVERTURE VIOLENTE AU-DELÀ DE 90° PEUT DEGONDER LA PORTE. IL EST RECOMMANDÉ D'UTILISER UN FERME-PORTE

La finitura consigliata e garantita per applicazioni box doccia , sauna e bagno turco è la „22“ (deep oxy 20 micron) - Acabado "22" (deep oxy 20 micron): garantizado y recomendado para box ducha, sauna y baño de vapor - The recommended and guaranteed finish for applications in shower enclosures, saunas and Turkish baths is 22 (Deep Oxidation 20 micron) - Die vorgeschlagene und garantierte Oberfläche für Anwendungen in Duschen, Saunas und Türkische Bäder ist die 22 (tiefe Oxidation 20 Mikron) - La finition recommandée pour les applications telles que les douches, saunas et hammams est la n°22 (anodisation naturelle 20 microns)

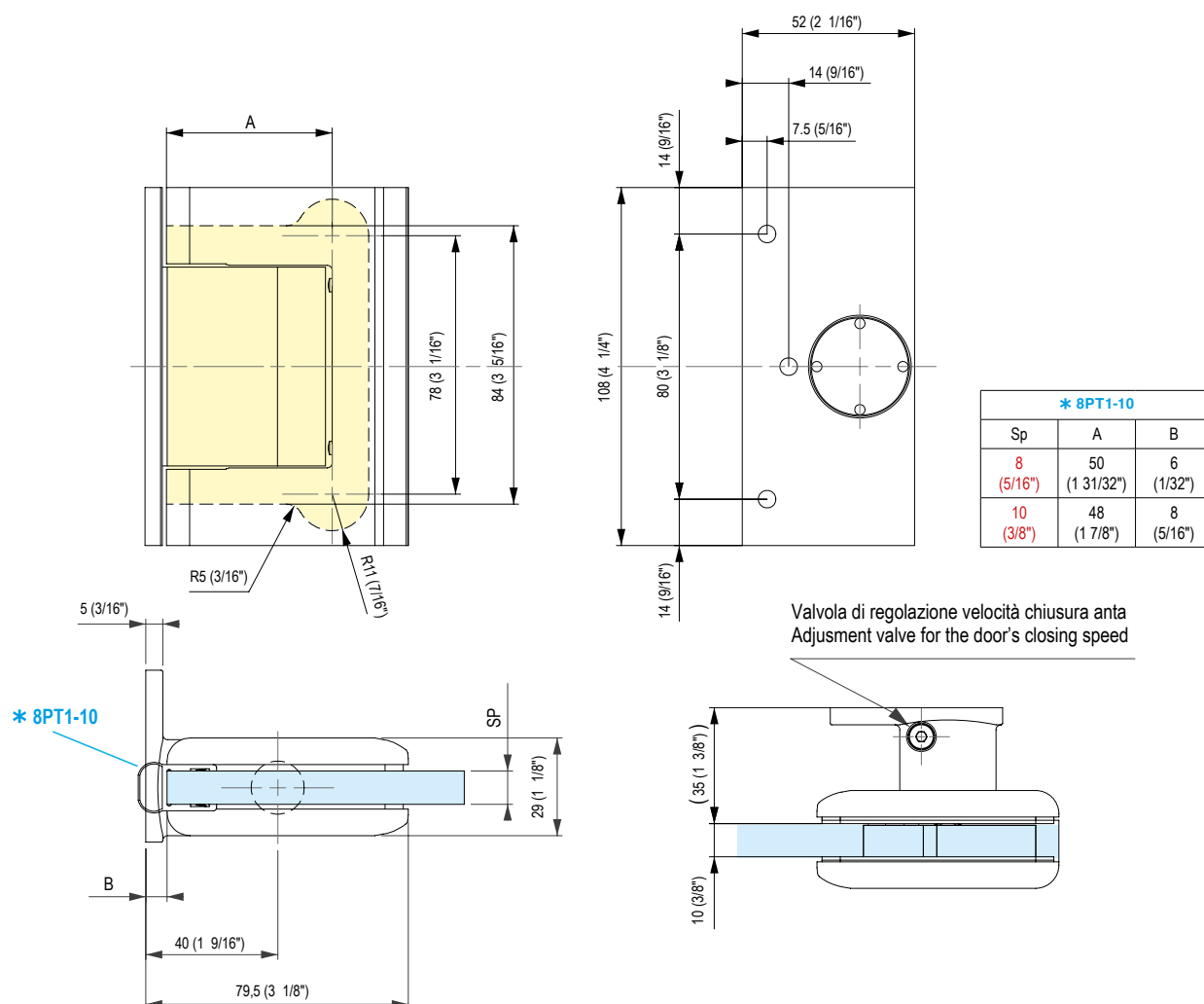

8015BT

BILOBA®

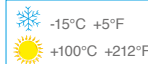
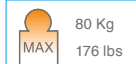
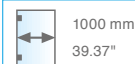
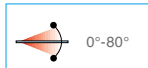

• Cerniera oleodinamica (vetro-vetro 180°) con regolazione delle velocità di chiusura dell'anta **specificata per applicazioni in ambienti umidi anche con alte temperature come saune e bagni turchi**. Monta tutte le guarnizioni OR del circuito oleodinamico in Viton e perno in acciaio inox AISI 420. Stop a 0° +90° -90°.

• Bisagra hidráulica (vidrio-vidrio 180°) con ajuste de la velocidad de cierre de la puerta; **nacida por ambientes húmedos y aplicaciones también con altas temperaturas - como sauna y baño turco**. Reúne todos los herrajes OR del circuito hidráulico en Viton y perno en acero inox 420 AISI. Freno en 0° + 90° -90°.

• Hydraulic hinge (glass to glass 180°) with adjustment of the closing speed, **conceived for applications in damp environments and also high temperature like saunas and Turkish baths**. The o-rings of the hydraulic circuit are made of Viton and the pivot is made of stainless steel AISI 420. Stop at 0° +90° -90°.

• Hydraulikscharnier (Glas-Glas 180°) mit Feststellung der Türschließgeschwindigkeit, **konzipiert für Anwendungen in feuchten Milieus und auch hohen Temperaturen wie Saunas und Türkische Bäder**. Die O-Ring Dichtungen des hydraulischen Kreises sind aus Viton und der Spindel ist aus Edelstahl AISI 420. Feststellung bei 0° +90° -90°.

• Charnière hydraulique (verre-verre) avec réglage de la vitesse de fermeture, **conçue pour des applications en milieu humide et/ou avec des températures élevées comme les saunas et hammams**. Les bagues du circuit hydraulique sont en caoutchouc et le système pivotant en inox AISI 420. Arrêt à 0°, +90° et -90°.

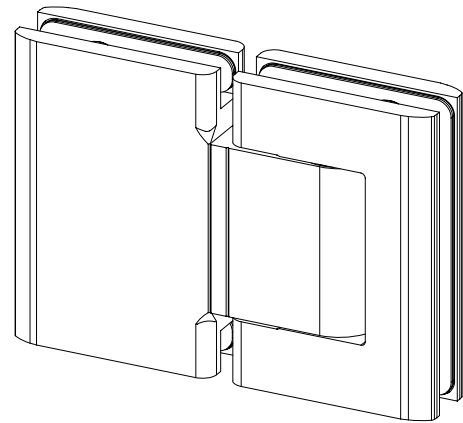

ATTENZIONE - PRECAUCIÓN - CAUTION - ACHTUNG - ATTENTION
APERTURE VIOLENTE OLTRE I 95° POTREBBERO CAUSARE LO SCARDINAMENTO. È CONSIGLIABILE L'APPLICAZIONE DI UN FERMAPORTA - APERTURA VIOLENTA ADEMÁS DE 95°, PODRÍA CAUSAR DAÑO. ACONSEJAMOS UTILIZAR UN FIJA PUERTA. - VIOLENT OPENING FURTHER THAN 95° COULD UNHINGE THE DOOR. WE SUGGEST TO INSTALL A DOOR STOP - HEFTIGE ÖFFNUNGEN MEHRALS 95° KÖNNTEN DIE TÜR AUSHEBEN. WIR SCHLAGEN DIE INSTALLIERUNG EINES TÜRHALTERS VOR - UNE OUVERTURE VIOLENTE AU-DELÀ DE 90° PEUT DEGONDER LA PORTE. IL EST RECOMMANDÉ D'UTILISER UN FERME-PORTE

La finitura consigliata e garantita per applicazioni box doccia, sauna e bagno turco è la „22“ (deep oxy 20 micron) - Acabado "22" (deep oxy 20 micron): garantizado y recomendado para box ducha, sauna y baño de vapor - The recommended and guaranteed finish for applications in shower enclosures, saunas and Turkish baths is 22 (Deep Oxidation 20 micron) - Die vorgeschlagene und garantierte Oberfläche für Anwendungen in Duschen, Saunas und Türkische Bäder ist die 22 (tiefe Oxidation 20 Mikron) - La finition recommandée pour les applications telles que les douches, saunas et hammams est la n°22 (anodisation naturelle 20 microns)

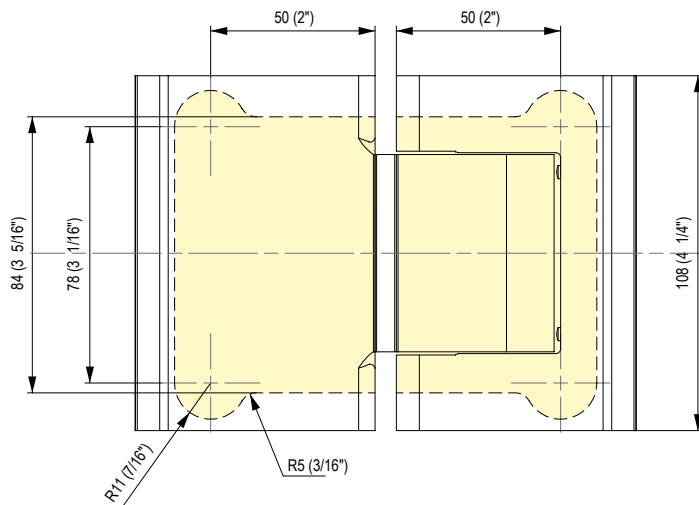

Solo a tirare
To pull only

8PT1-30

SP.8 / SP.10
(SP.5/16" / SP.3/8")

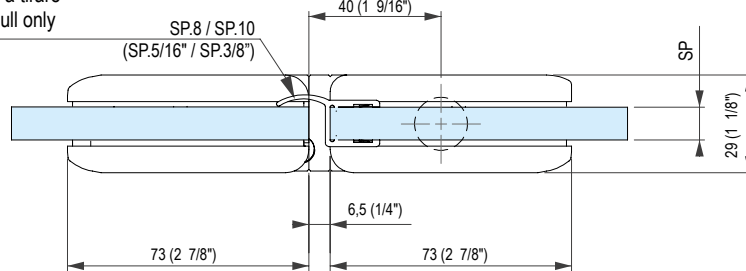

Valvola di regolazione
velocità chiusura anta
Adjustment valve for the
door's closing speed

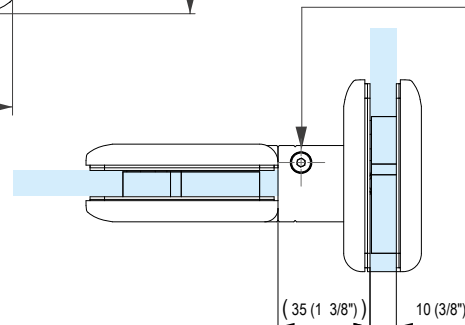

8060BT

BILOBA®

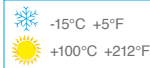
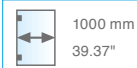
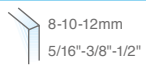
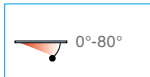

• Cerniera oleodinamica con regolazione delle velocità di chiusura dell'anta **specifica per applicazioni in ambienti umidi con alte temperature come saune e bagni turchi**. Monta tutte le guarnizioni OR del circuito oleodinamico in Viton e perno in acciaio inox AISI 420. Stop a 0° +90°.

• Bisagra hidráulica con ajuste de la velocidad de cierre de la puerta; **nacida por ambientes húmedos y aplicaciones con altas temperaturas - como saunas y baño turco**. Reúne todos los herrajes OR del circuito hidráulico en Viton y perno en acero inox 420 AISI. Freno en 0° + 90°.

• Hydraulic hinge with adjustment of the closing speed, **conceived for applications in damp environments and high temperature like saunas and Turkish baths**. The o-rings of the hydraulic circuit are made of Viton and the pivot is made of stainless steel AISI 420. Stop at 0° +90°.

• Hydraulikscharnier mit Feststellung der Türschließgeschwindigkeit, **konzipiert für Anwendungen in feuchten Milieus und hohen Temperaturen wie Saunas und Türkische Bäder**. Die O-Ring Dichtungen des hydraulischen Kreises sind aus Viton und der Spindel ist aus Edelstahl AISI 420. Feststellung bei 0° +90°.

• Charnière hydraulique avec réglage de la vitesse de fermeture, **conçue pour des applications en milieu humide et/ou avec des températures élevées comme les saunas et hammams**. Les bagues du circuit hydraulique sont en caoutchouc et le système pivotant en inox AISI 420. Arrêt à 0 +90°.

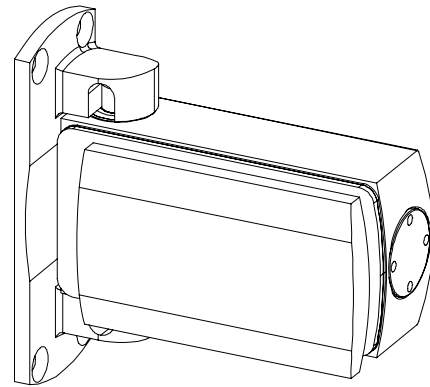

ATTENZIONE - PRECAUCIÓN - CAUTION - ACHTUNG - ATTENTION

APERTURE VIOLENTE OLTRE I 95° POTREBBERO CAUSARE LO SCARDINAMENTO. È CONSIGLIABILE L'APPLICAZIONE DI UN FERMAPORTA - APERTURA VIOLENTE ADEMÁS DE 95°, PODRÍA CAUSAR DAÑO. ACONSEJAMOS UTILIZAR UN FIJA PUERTA. - VIOLENT OPENING FURTHER THAN 95° COULD UNHINGE THE DOOR. WE SUGGEST TO INSTALL A DOOR STOP - HEFTIGE ÖFFNUNGEN MEHRALS 95° KÖNNTEN DIE TÜR AUSHEBEN. WIR SCHLAGEN DIE INSTALLIERUNG EINES TÜRHALTERS VOR - UNE OUVERTURE VIOLENTE AU-DELÀ DE 90° PEUT DEGONDER LA PORTE. IL EST RECOMMANDÉ D'UTILISER UN FERME-PORTE

La finitura consigliata e garantita per applicazioni box doccia, sauna e bagno turco è la „22“ (deep oxy 20 micron) - Acabado "22" (deep oxy 20 micron): garantizado y recomendado para box ducha, sauna y baño de vapor - The recommended and guaranteed finish for applications in shower enclosures, saunas and Turkish baths is 22 (Deep Oxidation 20 micron) - Die vorgeschlagene und garantierte Oberfläche für Anwendungen in Duschen, Saunas und Türkische Bäder ist die 22 (tiefe Oxidation 20 Mikron) - La finition recommandée pour les applications telles que les douches, saunas et hammams est la n°22 (anodisation naturelle 20 microns)

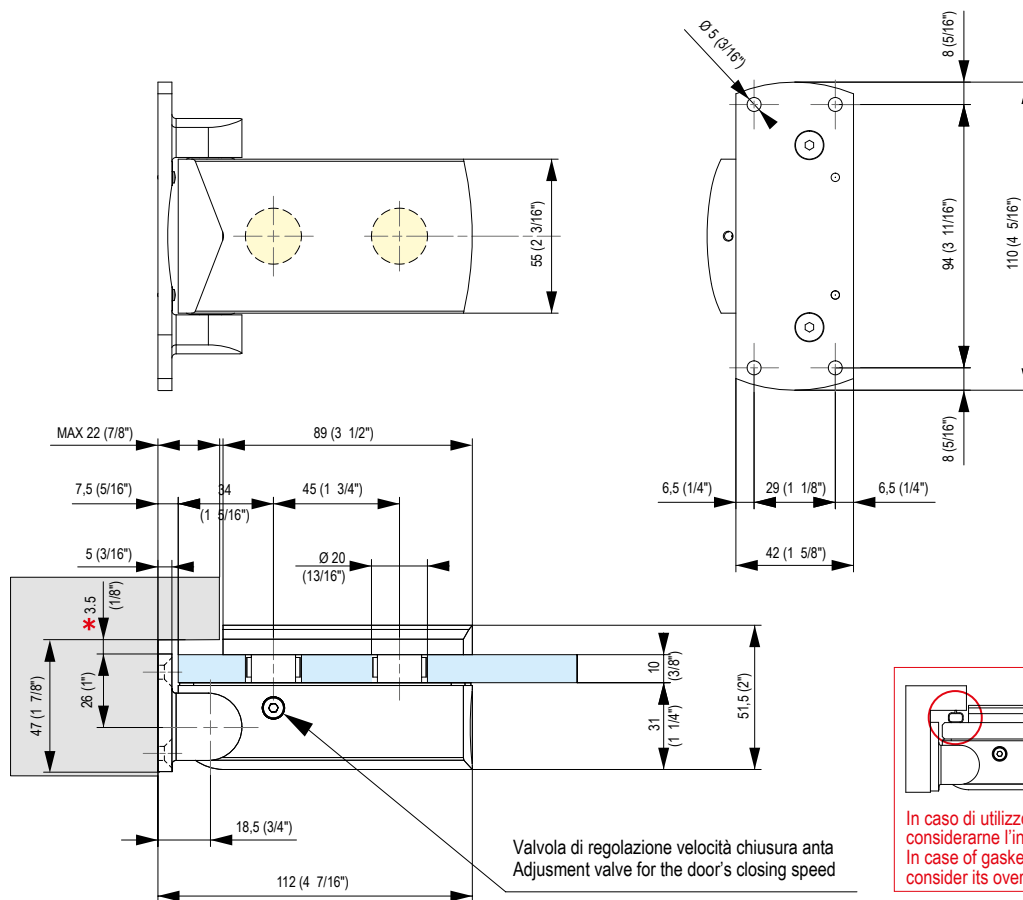

In caso di utilizzo guarnizione, considerare l'ingombro.
In case of gasket's usage, consider its overall dimension.

* Distanza minima da filo muro per consentire rotazione vetro
Minimum distance from wall edge in order to facilitate glass rotation

sistema oleodinamico / oildynamic system

kit Sauna



KSN8060



Alluminio / Aluminium - finiture / colors 22

Il cuore del kit è costituito dalle cerniere Biloba BT, nella speciale finitura 22, ossidazione profonda 20 micron. Il kit per l'ambiente Sauna è composto dalla 2 cerniere Biloba 8060BT in abbinamento al pomolo in legno art.5006BT. Non è previsto l'utilizzo di un profilo in quanto abitualmente la cabina è già predisposta con profili di battuta in legno.

El "corazón" del kit es hecho por las bisagras "BilobaBT" - especial acabado 22 - oxidación profunda 20 micrones. El kit de sauna es con dos bisagras "Biloba" 8060BT - en combinación al pomo de madera art.5006BT. No hay un perfil y esto depende de si la sauna ya está equipada de perfiles de madera.

The main product of this set is the hinge 8060BT, finish 22 (deep oxidation 20 micron). The set for sauna is composed of 2 Biloba hinges 8060BT and one wooden knob ref. 5006BT. As cabins are usually equipped with appropriate seals made of wood, no profile is foreseen in the set.

Hydraulische Scharniere für den Einsatz in Nassbereichen wie Duschen, Saunen und Dampfbädern. Ausgestattet mit allen Charakt Das Set Herz besteht aus den Bändern Biloba BT in der Sonderoberfläche 22 (tiefe Oxidation 20 Mikron). Der Bausatz für Saunen besteht aus 2 Bändern Biloba 8060BT und einem Holzknopf (Artikelnr. 5006BT). Gewöhnlich ist die Kabine mit Anschlagprofile aus Holz ausgerüstet , auf diesem Grund haben wir kein Profil vorgesehen.

La partie centrale de ce kit est la charnière Biloba BT, dans une finition spéciale 22, et une oxydation profonde de 20 microns. Ce système pour sauna est composé de 2 charnières Biloba 8060BT et d'une poignée en bois art.5006BT. Les cabines étant habituellement conçues en bois, aucun profil n'est prévu dans le kit.



sistema oleodinamico / oildynamic system

kit Bagno Turco

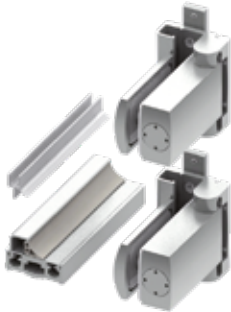

KBT8061



Alluminio / Aluminium - finiture / colors 22

Il cuore del kit è costituito dalle cerniere Biloba BT, nella speciale finitura 22, ossidazione profonda 20 micron. Il kit per l'ambiente Bagno Turco è composto da 2 cerniere Biloba 8061BT e dai profili Espro, 2 PCC08K + 2 PCC03K entrambi da 3,2 metri, che consentono di contenere efficacemente l'uscita del vapore. Nel kit Bagno turco il pomolo in legno o il maniglione sono opzionali e la scelta è a discrezione del cliente.

El "corazón" del kit es hecho por las bisagras "BilobaBT" - especial acabado 22 - oxidación profunda 20 micrones. El kit de baño de vapor es con dos bisagras "Biloba" 8061BT y perfiles "Espro" - 2 PCC08K + 2 PCC03K de 3,2 metros, que permiten contener eficazmente la salida de vapor. En el kit baño de vapor, el pomo en madera o el tirador son a petición y la selección es a discreción del cliente.

The main product of this set is the hinge 8060BT, finish 22 (deep oxidation 20 micron). The set for steam baths is composed of 2 Biloba hinges 8061BT and Espro profiles (2 PCC08K + 2 PCC03K both in lengths of

3,2 meters). These profiles avoid steam runoff. In this set the wooden knob or the handle are optional and the choice is at complete discretion of the customer.

Das Set Herz besteht aus den Bändern Biloba BT in der Sonderoberfläche 22 (tiefe Oxidation 20 Mikron). Der Bausatz für Dampfbäder besteht aus 2 Bändern Biloba 8061BT und Espro Profilen (2 Stk PCC08K + 2 Stk PCC03K, beide mit Länge 3,2 Meter). Diese Profile vermeiden Dampfaustritt sehr gut. Bei diesem Bausatz sind Holzknopf und Türdrücker optional und die Wahl ist nach Belieben des Kunden.

La partie centrale de ce kit est la charnière Biloba BT, dans une finition spéciale 22, et une oxydation profonde de 20 microns. Ce système pour hammams est composé de 2 charnières Biloba 8060BT, et des profils Espro, 2 PCC08K + 2 PCC03K, les deux de 3,2 mètres. Arrêt à +90°. Dans le kit pour hammams le bouton de porte en bois ou la poignée sont optionnels, il appartient au client de décider.



KSN8060

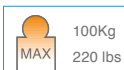
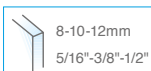

• Il kit per l'ambiente Sauna è composto da 2 cerniere Biloba 8060BT in abbinamento a pomolo in legno art.5006BT. Stop a +90°.

• El kit de sauna es con dos bisagras "Biloba" 8060BT - en combinación a pomo de madera art.5006BT. Freno a +90°.

• The sauna set comprises of : 2 Biloba hinges 8060BT, 1 pair of wooden knobs 5006BT. Stop at +90°.

• Der Bausatz für Saunen besteht aus 2 Bändern Biloba 8060BT und einem Holzknopf Artikelnr. 5006BT. Feststellung bei +90°.

• Le kit pour sauna est composé de 2 charnières Biloba 8060BT et du bouton en bois art.5006BT. Arrêt à +90°.



Compreso



8060BT (2X)
(vetro/vidrio/glass/Glas
8-10-12mm)



5006BT (1X)

Included

KBT8061

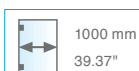
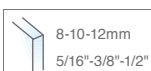

• Il kit per l'ambiente Bagno Turco è composto da 2 cerniere Biloba 8061BT e dai profili Espro, 2 PCC08K + 2 PCC03K + 2 PCC37 entrambi da 3,2 metri. Stop a +90°.

• El kit de baño de vapor es con dos bisagras "Biloba" 8061BT y perfiles "Espro" + 2 PCC08K + 2 PCC03K + 2 PCC37 de 3,2 metros. Freno a +90°.

• The steam baths set comprises of: 2 Biloba hinges 8061BT, 2 Espro profiles PCC08K, 2 Espro profiles PCC03K + 2 PCC37. Espro profiles are both in lengths of 3.2meters. Stop at +90°.

• Der Bausatz für Dampfbäder besteht aus 2 Bändern Biloba 8061BT und je zwei Espro Profilen PCC08K und PCC03K + 2 PCC37, beide 3,2 Meter lang. Feststellung bei +90°.

• Le kit pour hammams est composé de 2 charnières Biloba 8061BT et des profils Espro, 2 PCC08K + 2 PCC03K, de 3,2 mètres chacun. Arrêt à +90°.

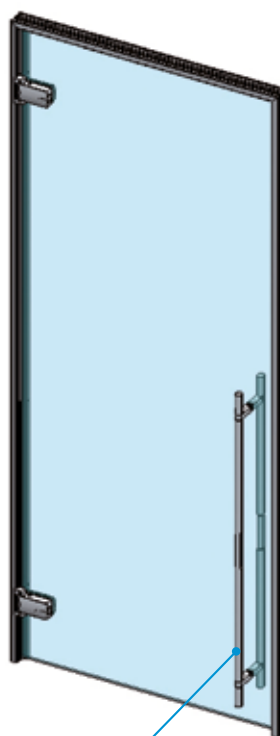

OPTIONAL

Compreso



8061BT (2X)
(vetro/vidrio/glass/Glas
8-10-12mm)



PCC03K/3 (2X)



PCC08K/3 (2X)



PCC37 (2X)

Included

KBT8061

DETTAGLIO PROFILI - DETAIL OF PROFILES

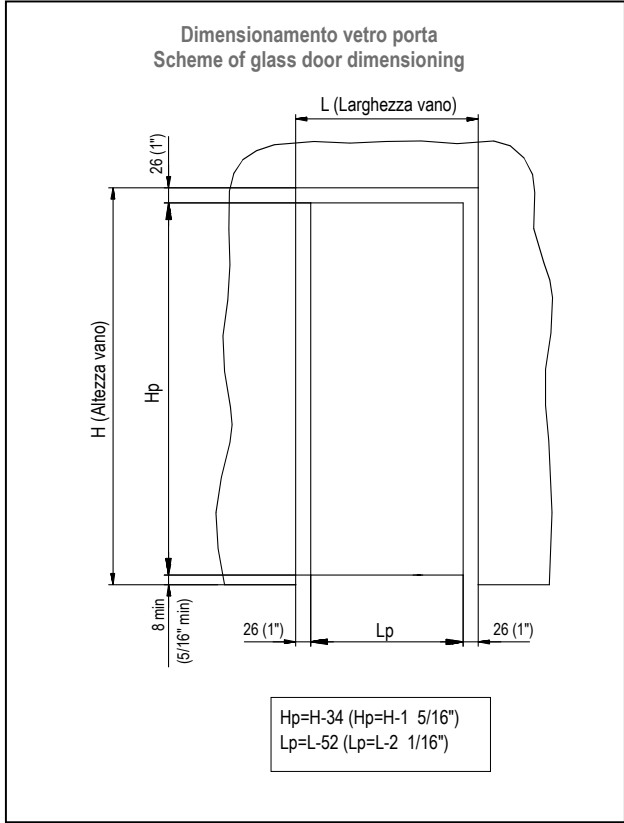
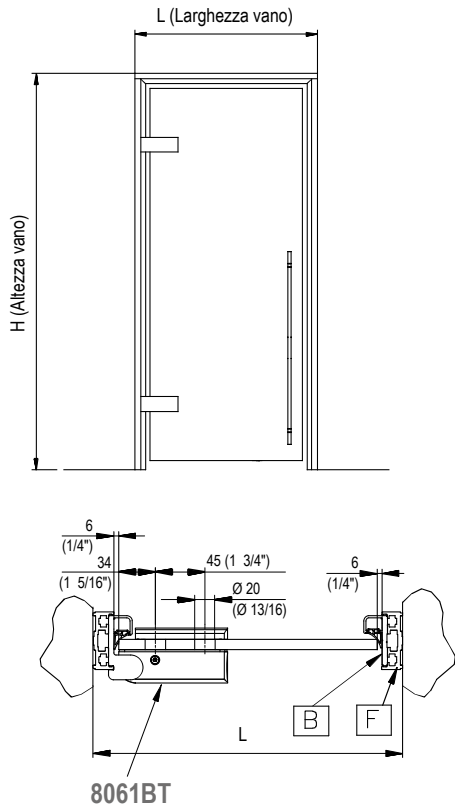

Formule di taglio profili - Fórmula de corte de los perfiles - Profiles cut formula - Profilansicht - Formule de coupe des profils

PCC08

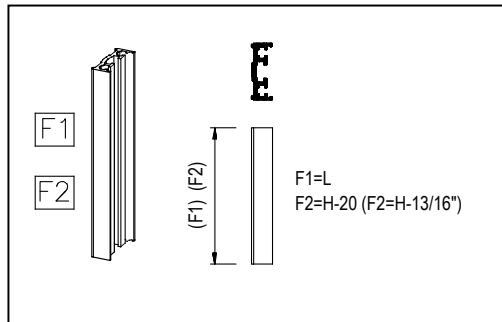
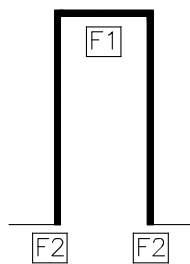

PCC03

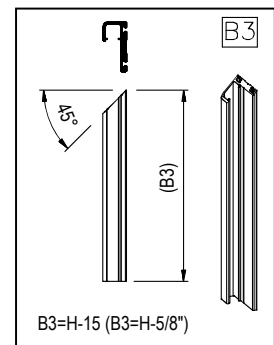
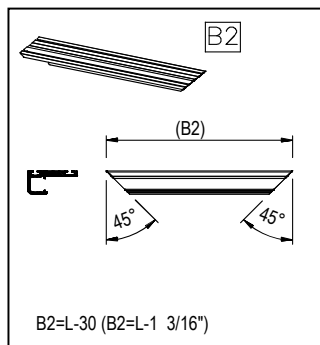
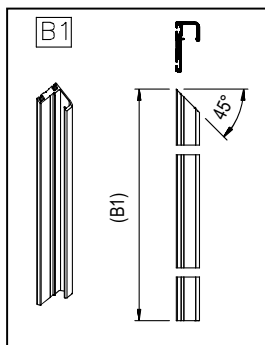
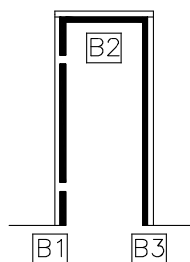

cerniere / hinges

serie **8500N** POLYMER



Ottone / Brass - finiture / colors 13-14-15-16-17-60-62

Serie di cerniere a scatto per box doccia vetro-muro, vetro-vetro e aletta sfalsata. Le principali caratteristiche sono: nuovo azionamento a polimero senza molla, completamente in ottone, senza viti a vista, regolazione del punto 0° sempre garantita. Testate e garantite per 100.000 cicli. E' possibile installare box doccia anche con pareti fuori squadra. Il design ed il meccanismo sono depositati e brevettati. L'assenza di viti a vista e le linee squadrate soddisfano le attuali tendenze del mercato rendendo possibile la realizzazione di box doccia in cristallo di alta gamma.

Serie de bisagras con retención para cabinas de ducha, disponibles en versión vidrio/pared, vidrio/pared con aleta desplazada y vidrio/vidrio. Sus características principales son: nuevo accionamiento con polímero, sin muelles; bisagras completamente en latón, sin tornillos visibles, regulación del punto 0° siempre garantizada. Testadas y garantizadas para 100.000 ciclos. Es posible la instalación en situaciones con paredes no perfectamente alineadas. Diseño y mecanismo son patentados. La ausencia de tornillos visibles y las líneas escuadradas satisfacen las tendencias actuales del mercado, haciendo posible la realización de cabinas de ducha de vidrio de alto nivel.

Clicking hinges series for shower cubicles: available in the Glass/Wall, Glass/Wall with offset fixing wing and Glass/Glass versions. Its main features are: new polymeric functioning without springs, completely in brass, without visible screws, 0° regulation always guaranteed. Tested and guaranteed for 100.000 cycles.

It is possible to install these hinges even in situations with not perfectly aligned walls. Design and mechanism are patented. The absence of visible screws and the squared lines meet the actual market trends, making the realisation of high-level glass shower cubicles possible.

Serie Duschtürpendelbänder, verfügbar das Model Glas-Wand, Glas-Glas und seitlich angeschlagen. Die Hauptmerkmale sind: neue Polymer Betätigung, vollständig aus Messing, ohne auf Sicht Schraube, Feststellung 0° ist immer garantiert. Die Bänder sind getestet und garantiert für 100.000 Zyklen. Es ist möglich auch Duschkabinen mit nicht vollkommen ausgerichtet Wände zu installieren Das Design und die Betätigung sind patentiert und hinterlegt. Das Fehlen von auf Sicht Schrauben und die quadratischen Linien entsprechen die aktuellen Markttrends und ermöglichen die Realisierung der oberen Marktsegmente Kristall- Duschkabinen.

Série de charnières à retenue verre-mur, verre-verre et pattes de fixation déportées. Ses caractéristiques principales sont: nouveau système polymère, entièrement en laiton, sans vis visible, avec réglage du point 0° toujours garanti. Les charnières sont testées et garanties pour 100.000 cycles. Il est possible d'installer une cabine de douche même si les murs ne sont pas parfaitement alignés. Le design et le mécanisme sont déposés et brevetés. L'absence de vis visibles et les lignes carrées répondent aux tendances actuelles du marché et permettent de réaliser des cabinas de douche, en verre, de qualité.





8500N Polymer



- Cerniera a scatto regolabile per box doccia. Stop a 0° +90° -90°.
- Bisagra con retención regulable para box ducha. Tope a 0° +90° -90°.
- Adjustable clicking hinge for shower boxes. Stop at 0° +90° -90°.
- Feinjustierbares Duschtürband. Feststellung bei 0°+90°-90°.
- Charnière à retenue réglable pour cabine de douche. Arrêt à 0°, +90° et -90°.

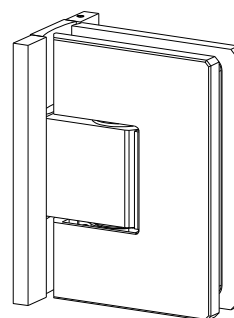

• Per porte con peso superiore ai 40 kg e di larghezza oltre i 900 mm si consiglia l'utilizzo di n° 3 cerniere. • Para puertas con un peso superior a los 40 kg y con más de 900 mm de ancho se aconseja utilizar 3 bisagras. • For doors with weight higher than 40 Kgs and largeness higher than 900 mm we suggest to use 3 hinges
 * Für Türe mit größerem Gewicht als 40 Kgs und größerer Breite als 900 mm schlagen wir die Verwendung von 3 Beschlägen vor. • Pour des portes d'un poids supérieur à 40 kg et d'une largeur supérieure à 900 mm, nous conseillons d'utiliser 3 charnières

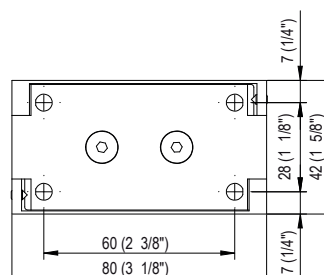
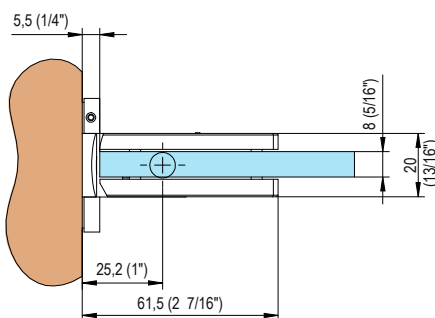
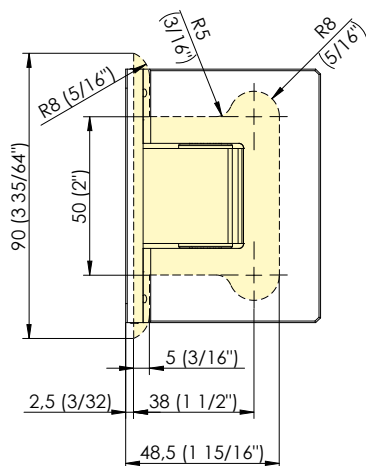
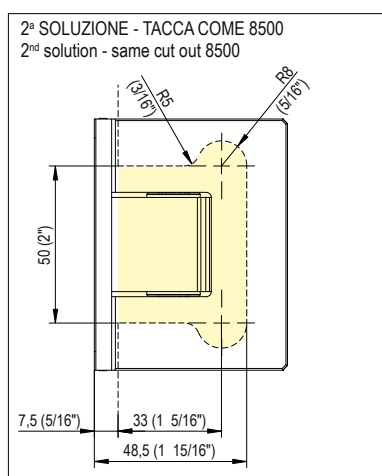
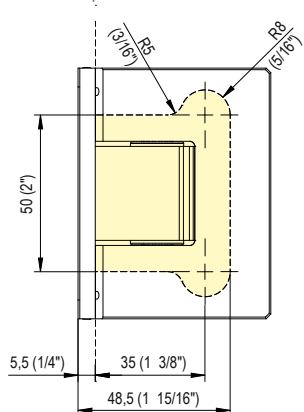

8501N Polymer



- Cerniera a scatto regolabile per box doccia con aletta spostata. Stop a 0° -90° +90°.
- Bisagra con retención regulable y con aleta desplazada para box ducha. Tope a 0° -90° +90°.
- Adjustable clicking hinge for shower boxes with offset fixing wing. Stop at 0° -90° +90°.
- Feinjustierbares Duschtürband mit einseitiger Montageplatte. Feststellung bei 0°+90°-90°.
- Charnière à retenue réglable pour cabine de douche avec pattes de fixation déportées. Arrêt à 0°, -90° et +90°.

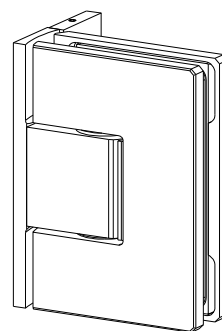

* Per porte con peso superiore ai 40 kg e di larghezza oltre i 900 mm si consiglia l'utilizzo di n° 3 cerniere. * Para puertas con un peso superior a los 40 kg y con más de 900 mm de ancho se aconseja utilizar 3 bisagras. * For doors with weight higher than 40 Kgs and largeness higher than 900 mm we suggest to use 3 hinges

* Für Türe mit größerem Gewicht als 40 Kgs und größerer Breite als 900 mm schlagen wir die Verwendung von 3 Beschlägen vor. * Pour des portes d'un poids supérieur à 40 kg et d'une largeur supérieure à 900 mm, nous conseillons d'utiliser 3 charnières

2ª SOLUZIONE - TACCA COME 8501 2nd solution - same cut out 8501

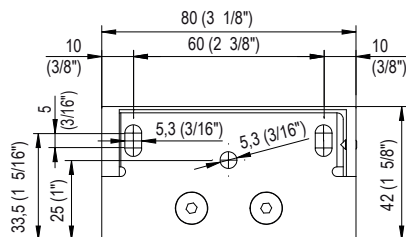
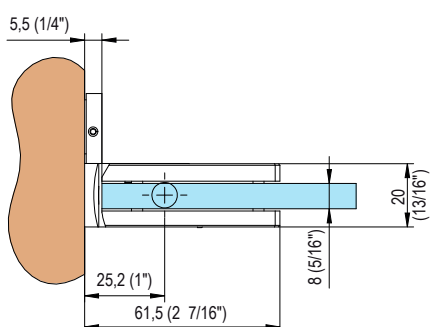
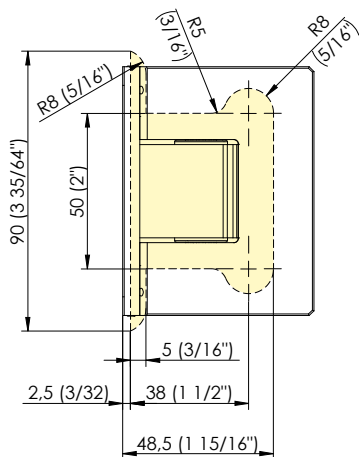
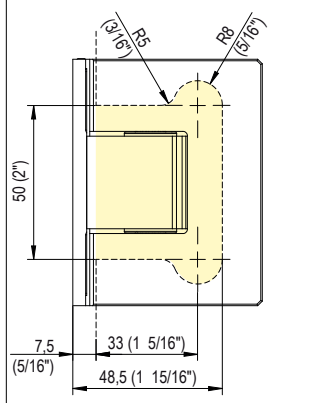
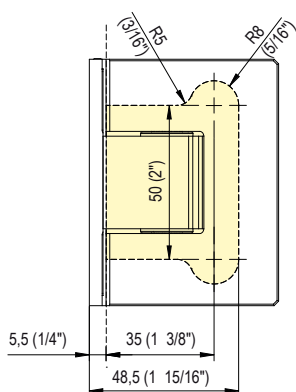

8505N Polymer

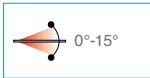
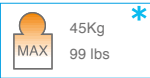
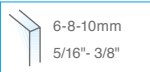

* Per porte con peso superiore ai 40 kg e di larghezza oltre i 900 mm si consiglia l'utilizzo di n° 3 cerniere
 * Para puertas con un peso superior a los 40 kg y con más de 900 mm de ancho se aconseja utilizar 3 bisagras
 * For doors with weight higher than 40 Kgs and largeness higher than 900 mm we suggest to use 3 hinges
 * Für Türe mit größerem Gewicht als 40 Kgs und größerer Breite als 900 mm schlagen wir die Verwendung von 3 Beschlägen vor
 * Pour des portes d'un poids supérieur à 40 kg et d'une largeur supérieure à 900 mm, nous conseillons d'utiliser 3 charnières

- Cerniera a scatto regolabile vetro-vetro 180° per box doccia. Stop a 0° +90° -90°.
- Bisagra con retención regulable vidrio-vidrio 180° para box ducha. Tope a 0° -90° +90°.
- Adjustable clicking hinge glass to glass for shower boxes. 180°. Stop at 0° -90° +90°.
- Feinjustierbares Duschtürband Glas-Glas, 180°. Feststellung bei 0°+90°-90°.
- Charnière à retenue réglable verre-verre 180° pour cabine de douche. Arrêt à 0°, +90° et -90°.

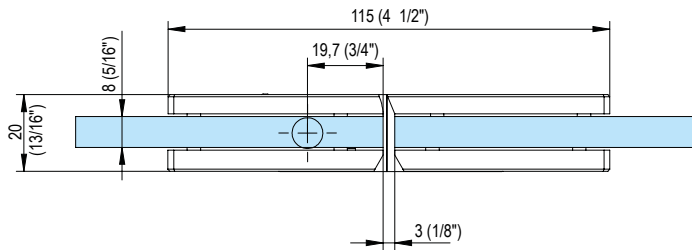
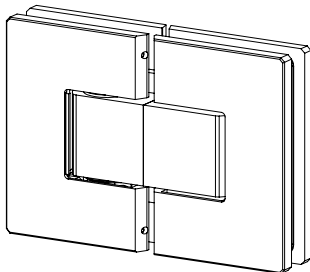
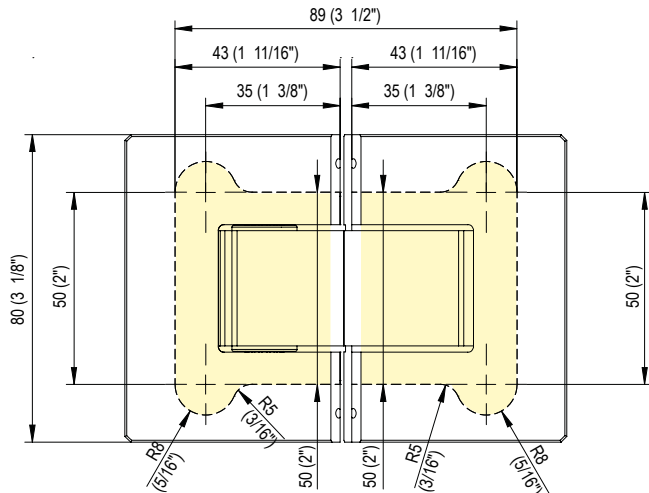

485E13 Polymer

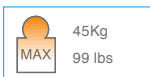
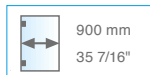
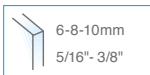

- Angolare muro-vetro per box doccia.
- Angular pared-vidrio para box ducha.
- Angular fitting wall to glass for shower boxes.
- Winkelverbinder Wand-Glas für Dusche.
- Cornière mur-verre pour cabine de douche.

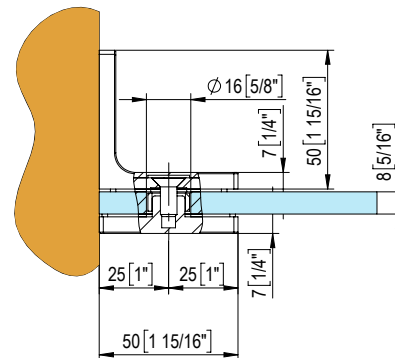
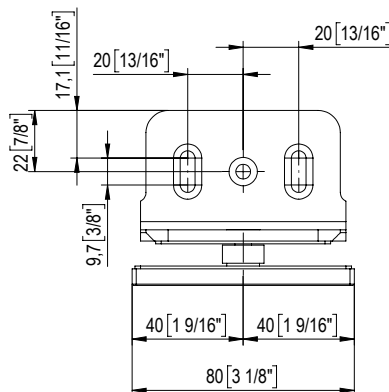
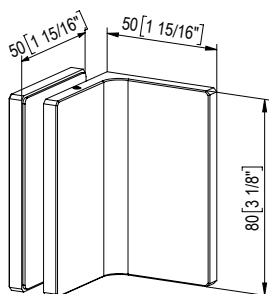
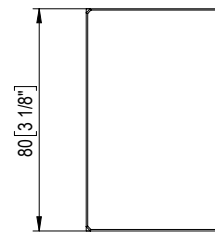

485E53

Polymer

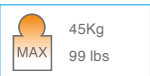
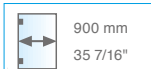
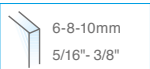

- Angolare vetro-vetro per box doccia.
- Angular vidrio-vidrio para box ducha.
- Angular fitting glass to glass for shower boxes.
- Winkelverbinder Glas-Glas für Dusche.
- Cornière verre-verre pour cabine de douche.

CUT 1	Glass Thickness	A
	6 [1/4"]	32 [1 1/4"]
	8 [5/16"]	34 [1 5/16"]
10 [3/8"]	36 [1 7/16"]	

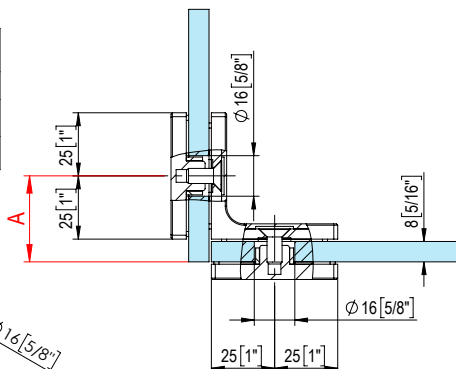
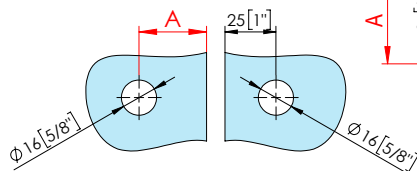

CUT 2	Glass Thickness	A
	6 [1/4"]	31 [1 1/4"]
	8 [5/16"]	33 [1 5/16"]
10 [3/8"]	35 [1 3/8"]	

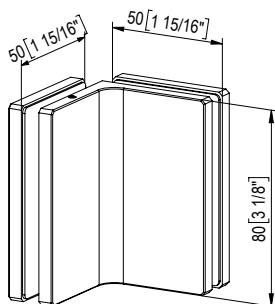
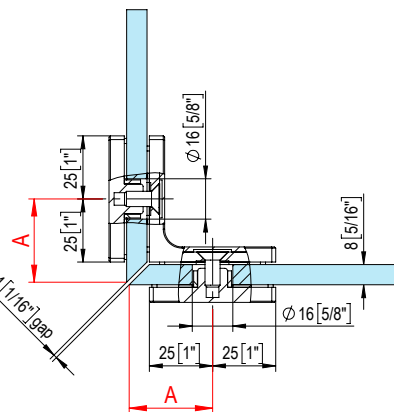
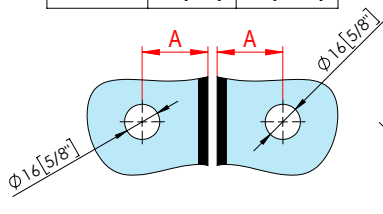

cerniere / hinges serie **8500**



8500
8500R*



8501
8501R*



8505
8505R*



8506
8506R*



8507
8507R*



Ottone / Brass - finiture / colors 13-14-15-16-17-60-62

Sistema per box doccia composto da cerniere a scatto, vetro muro e/o vetro-vetro. È il modo più semplice ed economico per avere un box doccia in cristallo, di qualità. Nelle versioni regolabili, grazie alle loro particolari caratteristiche, è possibile installare box doccia anche in condizioni di pareti fuori squadra. Le posizioni di stop di tutta la serie, sono garantite per un numero molto elevato di cicli nel tempo. Disponibile anche nella versione regolabile (R).

Sistema para mampara de baño compuesto de bisagras con retención, pared-vidrio y vidrio-vidrio. Es la manera más fácil y económica para disfrutar de una ducha acristalada y de gran calidad. Existen modelos regulables que eliminan los problemas de paredes fuera de escuadra. La posición de stop de toda la serie está garantizada por un número muy elevado de ciclos. Disponible en la versión regulable (R).

System for shower enclosure composed of clicking hinges, glass-wall and/or glass-glass. It is the easiest and cheapest way to get a crystal glass shower enclosure of good quality. Choosing the adjustable series it is possible to install shower enclosures even with off-square walls.

The stop positions of the whole series are assured for a very high number of cycles. Available in the adjustable version (R), too.

System für Duschtüren mit Glstürpendelbändern in den Varianten Glas-Wand und/oder Glas-Glas. Einfache und billige Art, um eine Kristallduschkabine aus guter Qualität zu realisieren. Die einstellbaren Varianten ermöglichen die Montage auch bei Wänden mit schiefer Abschnitt. Die Stopposition ist für sehr viele Zyklen garantiert. Auch in den einstellbaren Varianten der einstellbaren Variante (R) verfügbar.

Système pour cabine de douche composé de charnières à retenue, verre-mur et verre-verre. C'est la solution la plus simple et la plus économique, pour avoir une cabine de douche, en verre, de qualité. Les positions d'arrêt de la série entière sont garanties pour un très grand nombre de cycles. La charnière est également disponible en version réglable (R).





8500

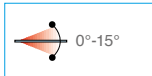
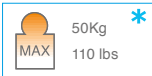
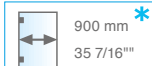
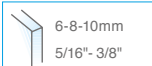

- Cerniera a scatto per box doccia. Stop a 0° +90° -90°.
- Bisagra con retención para box ducha. Tope a 0° +90° -90°.
- Clicking hinge for shower boxes. Stop at 0° +90° -90°.
- Duschtürpendelband Glas-Wand, Feststellung bei 0°+90°-90°.
- Charnière à retenue pour cabine de douche. Arrêt à 0°, +90° et -90°.

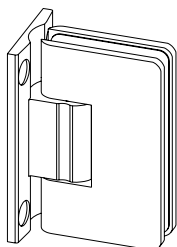

- * Per porte con peso superiore ai 40 kg e di larghezza oltre i 700 mm si consiglia l'utilizzo di n° 3 cerniere
- * Para puertas con un peso superior a los 40 kg y con más de 700 mm de ancho se aconseja utilizar 3 bisagras
- * For doors with weight higher than 40 Kgs and largeness higher than 700 mm we suggest to use 3 hinges
- * Für Türe mit größerem Gewicht als 40 Kgs und größerer Breite als 700 mm schlagen wir die Verwendung von 3 Beschlägen vor
- * Pour des portes d'un poids supérieur à 40 kg et d'une largeur supérieure à 700 mm, nous conseillons d'utiliser 3 charnières

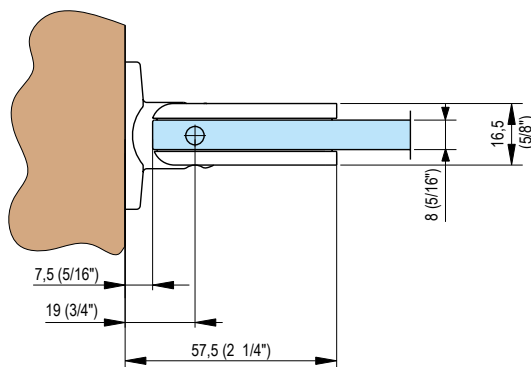
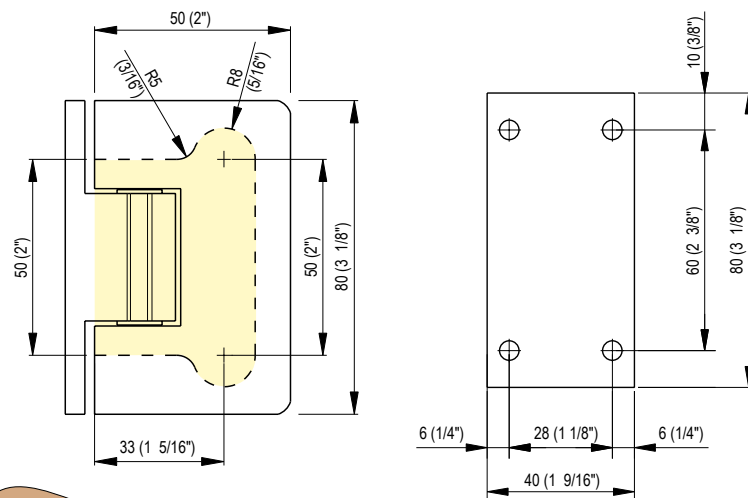

8501

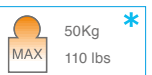
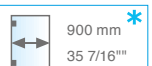
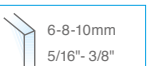

- Cerniera a scatto per box doccia con aletta spostata. Stop a 0° +90° -90°.
- Bisagra con retención y aleta desplazada para box ducha. Tope a 0° +90° -90°.
- Clicking hinge with offset fixing wing for shower boxes. Stop at 0° +90° -90°.
- Duschtürpendelband Glas-Wand, mit einseitiger Montageplatte, Feststellung bei 0°+90°-90°.
- Charnière à retenue pour cabine de douche avec pattes de fixation déportées. Arrêt à 0°, +90° et -90°.

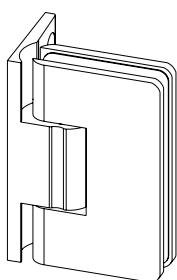

- * Per porte con peso superiore ai 40 kg e di larghezza oltre i 700 mm si consiglia l'utilizzo di n° 3 cerniere
- * Para puertas con un peso superior a los 40 kg y con más de 700 mm de ancho se aconseja utilizar 3 bisagras
- * For doors with weight higher than 40 Kgs and largeness higher than 700 mm we suggest to use 3 hinges
- * Für Türe mit größerem Gewicht als 40 Kgs und größerer Breite als 700 mm schlagen wir die Verwendung von 3 Beschlägen vor
- * Pour des portes d'un poids supérieur à 40 kg et d'une largeur supérieure à 700 mm, nous conseillons d'utiliser 3 charnières

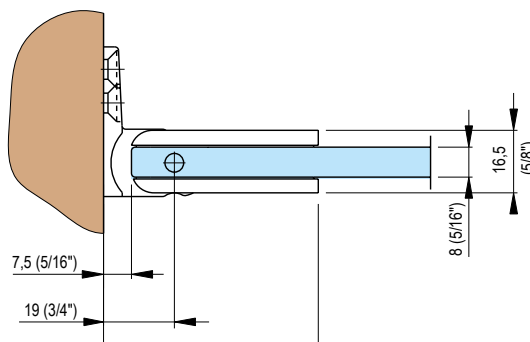
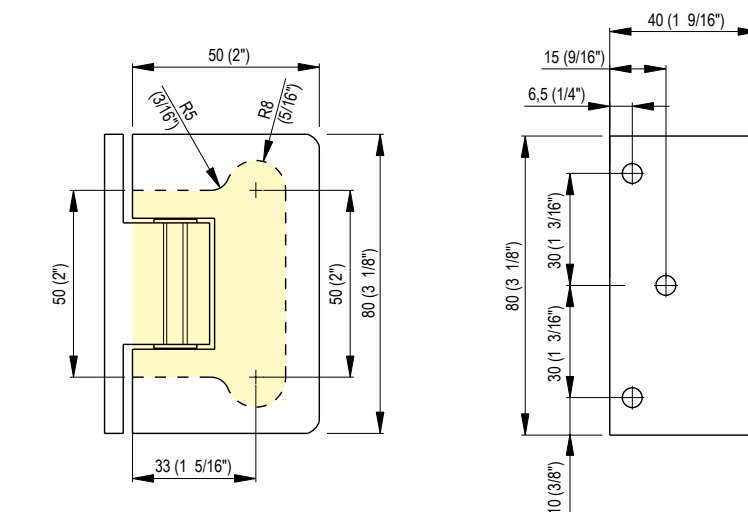

8505

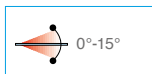
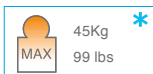
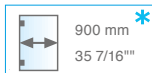
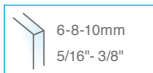

• Cerniera a scatto vetro-vetro 180° per box doccia. Stop a 0° +90° -90°.

• Bisagra con retención vidrio-vidrio 180° para box ducha. Tope a 0° +90° -90°.

• Clicking hinge glass to glass for shower boxes. 180°. Stop at 0° +90° -90°.

• Duschtürpendelband Glas-Glas, 180°. Feststellung bei 0°+90°-90°.

• Charnière à retenue verre-verre 180° pour cabine de douche. Arrêt à 0°, +90° et -90°.

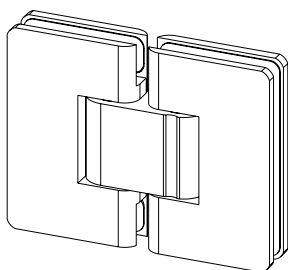

- * Per porte con peso superiore ai 40 kg e di larghezza oltre i 700 mm si consiglia l'utilizzo di n° 3 cerniere
- * Para puertas con un peso superior a los 40 kg y con más de 700 mm de ancho se aconseja utilizar 3 bisagras
- * For doors with weight higher than 40 Kgs and largeness higher than 700 mm we suggest to use 3 hinges
- * Für Türe mit größerem Gewicht als 40 Kgs und größerer Breite als 700 mm schlagen wir die Verwendung von 3 Beschlägen vor
- * Pour des portes d'un poids supérieur à 40 kg et d'une largeur supérieure à 700 mm, nous conseillons d'utiliser 3 charnières

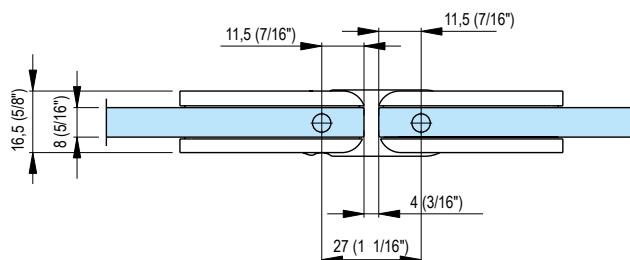
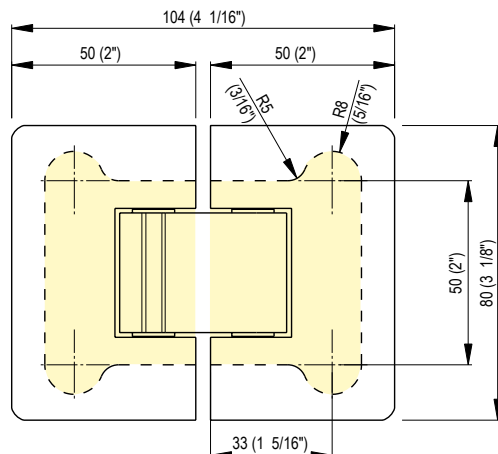

8506

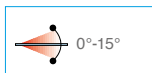
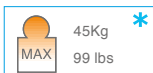
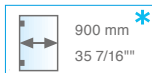
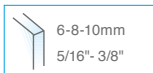

• Cerniera a scatto vetro-vetro 90° per box doccia. Stop a 0° +90° -90°.

• Bisagra con retención vidrio-vidrio 90° para box ducha. Tope a 0° +90° -90°.

• Clicking hinge glass to glass for shower boxes. 90°. Stop at 0° +90° -90°.

• Duschtürpendelband Glas-Glas, 90°. Feststellung bei 0°+90°-90°.

• Charnière à retenue verre-verre 90° pour cabine de douche. Arrêt à 0°, +90° et -90°.

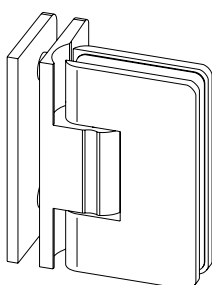

- * Per porte con peso superiore ai 40 kg e di larghezza oltre i 700 mm si consiglia l'utilizzo di n° 3 cerniere
- * Para puertas con un peso superior a los 40 kg y con más de 700 mm de ancho se aconseja utilizar 3 bisagras
- * For doors with weight higher than 40 Kgs and largeness higher than 700 mm we suggest to use 3 hinges
- * Für Türe mit größerem Gewicht als 40 Kgs und größerer Breite als 700 mm schlagen wir die Verwendung von 3 Beschlägen vor
- * Pour des portes d'un poids supérieur à 40 kg et d'une largeur supérieure à 700 mm, nous conseillons d'utiliser 3 charnières

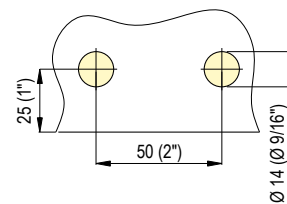
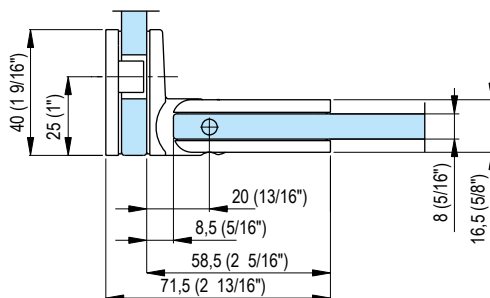
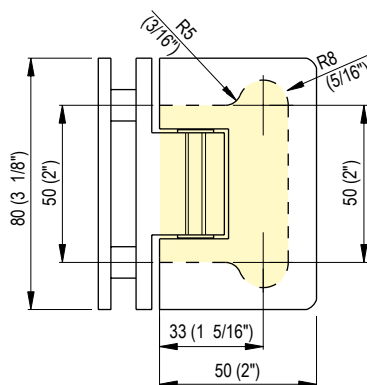

8507

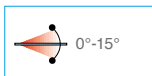
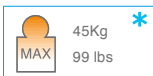
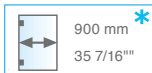
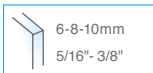

- Cerniera a scatto vetro-vetro 135° per box doccia. Stop a 0° +90° -90°.
- Bisagra con retención vidrio-vidrio 135° para box ducha. Tope a 0° +90° -90°.
- Clicking hinge glass to glass for shower boxes. 135°. Stop at 0° +90° -90°.
- Duschtürpendelband, Glas-Glas, 135°. Feststellung bei 0°+90°-90°.
- Charnière à retenue verre-verre 135° pour cabine de douche. Arrêt à 0°, +90° et -90°.

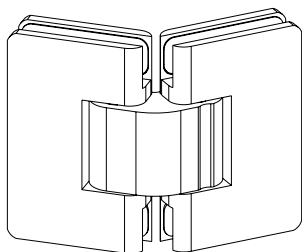

- * Per porte con peso superiore ai 40 kg e di larghezza oltre i 700 mm si consiglia l'utilizzo di n° 3 cerniere
- * Para puertas con un peso superior a los 40 kg y con más de 700 mm de ancho se aconseja utilizar 3 bisagras
- * For doors with weight higher than 40 Kgs and largeness higher than 700 mm we suggest to use 3 hinges
- * Für Türe mit größerem Gewicht als 40 Kgs und größerer Breite als 700 mm schlagen wir die Verwendung von 3 Beschlägen vor
- * Pour des portes d'un poids supérieur à 40 kg et d'une largeur supérieure à 700 mm, nous conseillons d'utiliser 3 charnières

STESSA TASCA
MISMA MUESCA
SAME NOTCH
SELBER EINSCHNITT

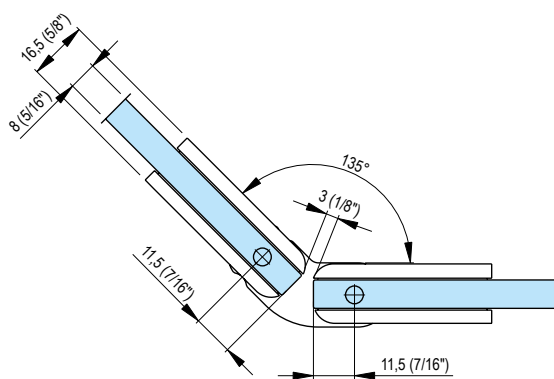
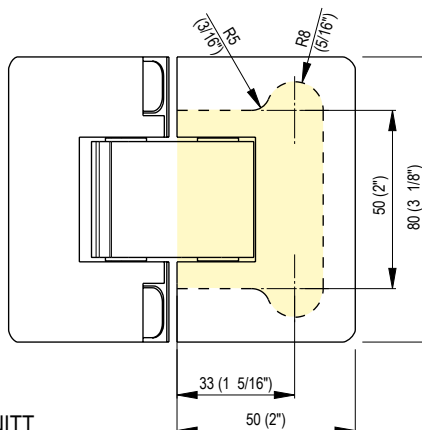

8500R

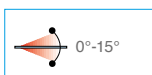
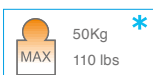
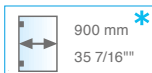
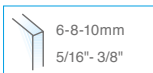

- Cerniera a scatto regolabile per box doccia. Stop a 0° +90° -90°.
- Bisagra con retención regulable para box ducha. Tope a 0° +90° -90°.
- Adjustable clicking hinge for shower boxes. Stop at 0° +90° -90°.
- Feinjustierbares Duschtürband, Feststellung bei 0°+90°-90°.
- Charnière à retenue réglable pour cabine de douche. Arrêt à 0°, +90° et -90°.

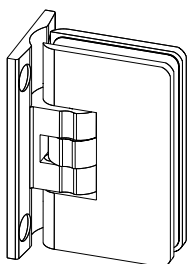

- * Per porte con peso superiore ai 40 kg e di larghezza oltre i 700 mm si consiglia l'utilizzo di n° 3 cerniere
- * Para puertas con un peso superior a los 40 Kg y con más de 700 mm de ancho se aconseja utilizar 3 bisagras
- * For doors with weight higher than 40 Kgs and largeness higher than 700 mm we suggest to use 3 hinges
- * Für Türe mit größerem Gewicht als 40 Kgs und größerer Breite als 700 mm schlagen wir die Verwendung von 3 Beschlägen vor
- * Pour des portes d'un poids supérieur à 40 kg et d'une largeur supérieure à 700 mm, nous conseillons d'utiliser 3 charnières

2° SOLUZIONE - TACCA COME 8500
2nd solution - same cut out 8500

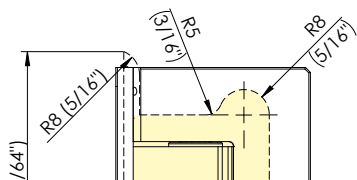
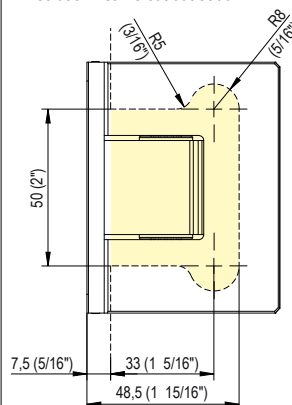
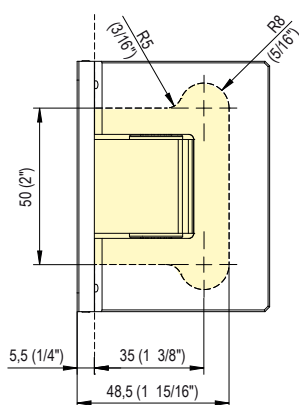

8501R

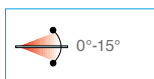
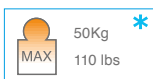
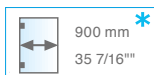
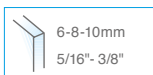

• Cerniera a scatto regolabile per box doccia con aletta spostata. Stop a 0° -90° +90°.

• Bisagra con retención regulable y con aleta desplazada para box ducha. Tope a 0° -90° +90°.

• Adjustable clicking hinge for shower boxes with offset fixing wing. Stop at 0° -90° +90°.

• Feinjustierbares Duschtürband mit einseitiger Montageplatte. Feststellung bei 0°+90°-90°.

• Charnière à retenue réglable pour cabine de douche avec pattes de fixation déportées. Arrêt à 0°, -90° et +90°.

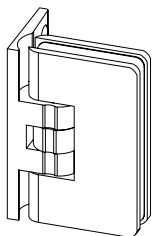

- * Per porte con peso superiore ai 40 kg e di larghezza oltre i 700 mm si consiglia l'utilizzo di n° 3 cerniere
- * Para puertas con un peso superior a los 40 kg y con más de 700 mm de ancho se aconseja utilizar 3 bisagras
- * For doors with weight higher than 40 Kgs and largeness higher than 700 mm we suggest to use 3 hinges
- * Für Türe mit größerem Gewicht als 40 Kgs und größerer Breite als 700 mm schlagen wir die Verwendung von 3 Beschlägen vor
- * Pour des portes d'un poids supérieur à 40 kg et d'une largeur supérieure à 700 mm, nous conseillons d'utiliser 3 charnières

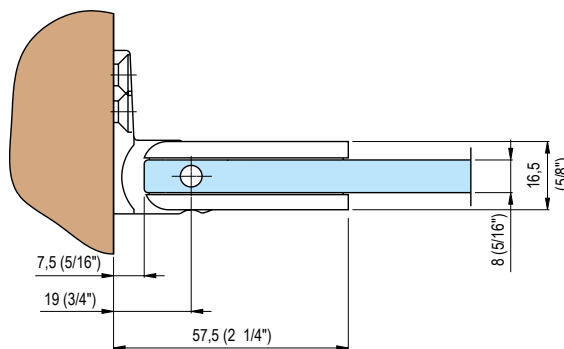
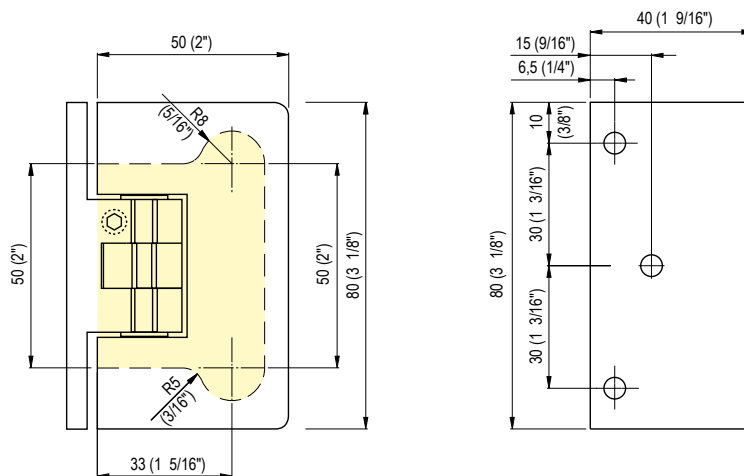

8505R

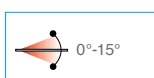
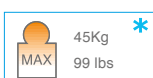
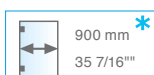
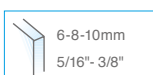

• Cerniera a scatto regolabile vetro-vetro 180° per box doccia. Stop a 0° +90° -90°.

• Bisagra con retención regulable vidrio-vidrio 180° para box ducha. Tope a 0° -90° +90°.

• Adjustable clicking hinge glass to glass for shower boxes. 180°. Stop at 0° -90° +90°.

• Feinjustierbares Duschtürband Glas-Glas, 180°. Feststellung bei 0°+90°-90°.

• Charnière à retenue réglable verre-verre 180° pour cabine de douche. Arrêt à 0°, +90° et -90°.

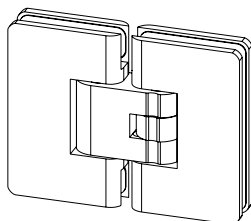

- * Per porte con peso superiore ai 40 kg e di larghezza oltre i 700 mm si consiglia l'utilizzo di n° 3 cerniere
- * Para puertas con un peso superior a los 40 kg y con más de 700 mm de ancho se aconseja utilizar 3 bisagras
- * For doors with weight higher than 40 Kgs and largeness higher than 700 mm we suggest to use 3 hinges
- * Für Türe mit größerem Gewicht als 40 Kgs und größerer Breite als 700 mm schlagen wir die Verwendung von 3 Beschlägen vor
- * Pour des portes d'un poids supérieur à 40 kg et d'une largeur supérieure à 700 mm, nous conseillons d'utiliser 3 charnières

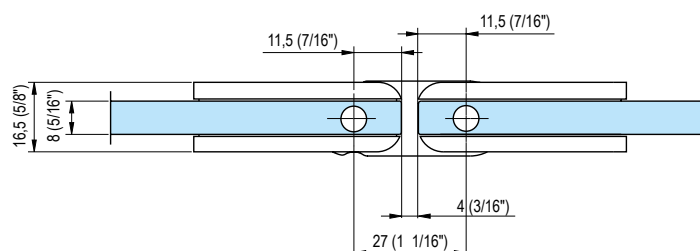
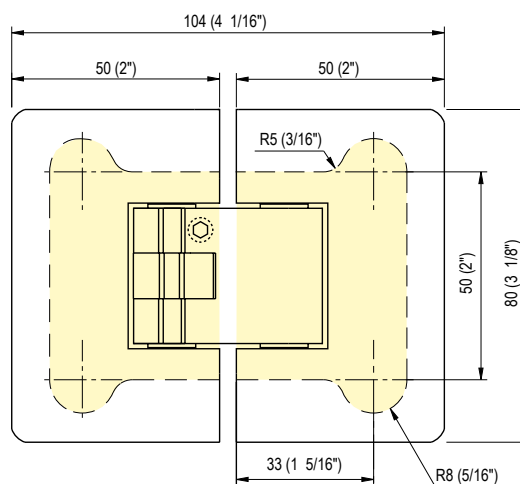

8506R

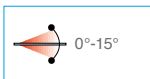
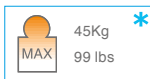
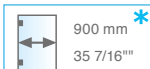

- Cerniera a scatto regolabile vetro-vetro 90° per box doccia. Stop a 0° +90° -90°.
- Bisagra con retención regulable vidrio-vidrio 90° para box ducha. Tope a 0° +90° -90°.
- Adjustable clicking hinge glass to glass for shower boxes. 90°. Stop at 0° +90° -90°.
- Feinjustierbares Duschtürband Glas-Glas, 90°. Feststellung bei 0°+90°-90°.
- Charnière à retenue réglable verre-verre 90° pour cabine de douche. Arrêt à 0°, +90° et -90°.

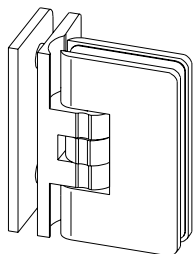

- * Per porte con peso superiore ai 40 kg e di larghezza oltre i 700 mm si consiglia l'utilizzo di n° 3 cerniere
- * Para puertas con un peso superior a los 40 kg y con más de 700 mm de ancho se aconseja utilizar 3 bisagras
- * For doors with weight higher than 40 Kgs and largeness higher than 700 mm we suggest to use 3 hinges
- * Für Türe mit größerem Gewicht als 40 Kgs und größerer Breite als 700 mm schlagen wir die Verwendung von 3 Beschlägen vor
- * Pour des portes d'un poids supérieur à 40 kg et d'une largeur supérieure à 700 mm, nous conseillons d'utiliser 3 charnières

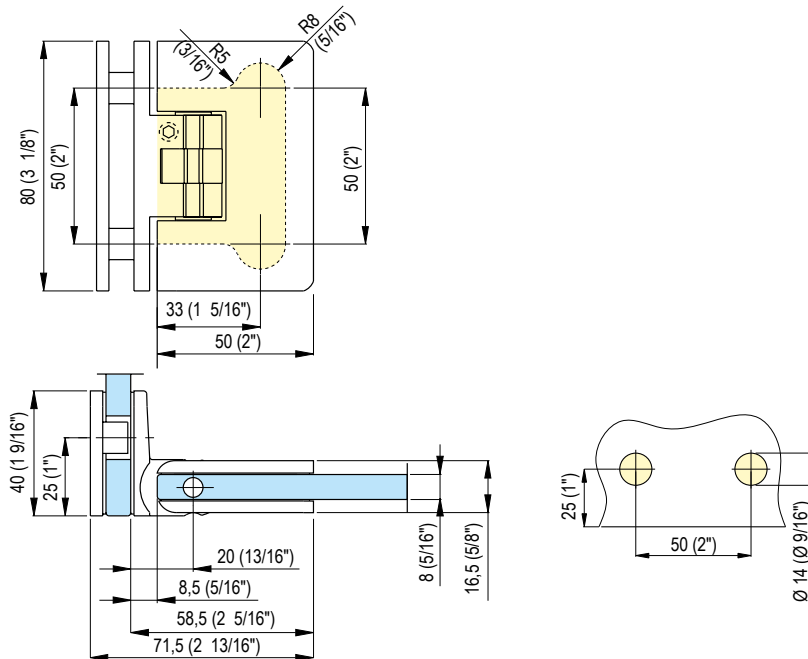

8507R

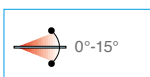
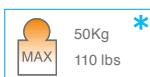
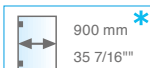
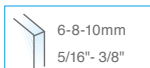

- Cerniera a scatto regolabile vetro-vetro 135° per box doccia. Stop a 0° +90° -90°.
- Bisagra con retención regulable vidrio-vidrio 135° para box ducha. Tope a 0° +90° -90°.
- Adjustable clicking hinge glass to glass for shower boxes. 135°. Stop at 0° +90° -90°.
- Feinjustierbares Duschtürband Glas-Glas, 135°. Feststellung bei 0°+90°-90°.
- Charnière à retenue réglable verre-verre 135° pour cabine de douche. Arrêt à 0°, +90° et -90°.

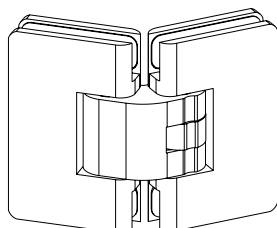

- * Per porte con peso superiore ai 40 kg e di larghezza oltre i 700 mm si consiglia l'utilizzo di n° 3 cerniere
- * Para puertas con un peso superior a los 40 kg y con más de 700 mm de ancho se aconseja utilizar 3 bisagras
- * For doors with weight higher than 40 Kgs and largeness higher than 700 mm we suggest to use 3 hinges
- * Für Türe mit größerem Gewicht als 40 Kgs und größerer Breite als 700 mm schlagen wir die Verwendung von 3 Beschlägen vor
- * Pour des portes d'un poids supérieur à 40 kg et d'une largeur supérieure à 700 mm, nous conseillons d'utiliser 3 charnières

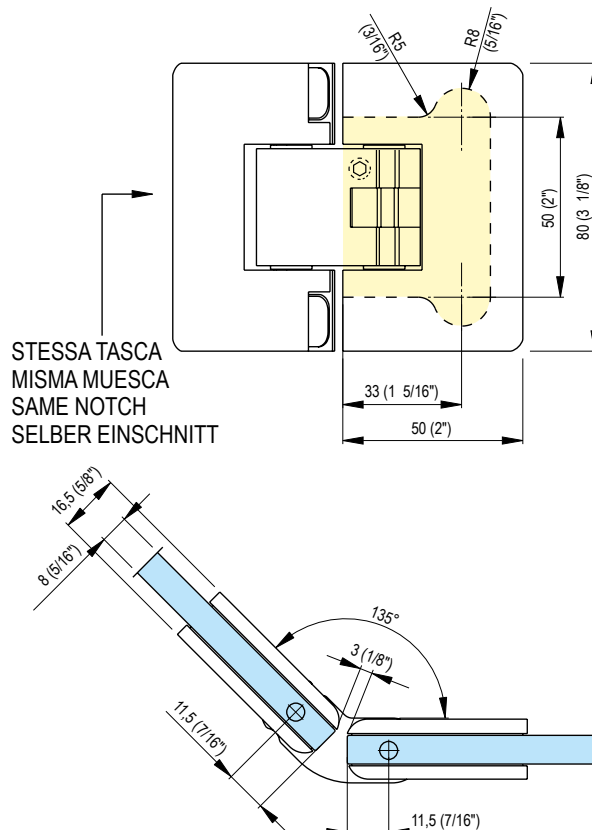

STESSA TASCA
MISMA MUESCA
SAME NOTCH
SELBER EINSCHNITT

cerniere / hinges serie **8560**



8560



8565



8566



8567

Ottone / Brass - finiture / colors 13-14-15-16-17-60-62

Cerniera a scatto per box doccia con anta solo a tirare. Il suo design avvolgente, racchiude un meccanismo particolarmente robusto. Grazie alla particolare forma dell'aletta, non necessita di tagliare la guarnizione assicurando una eccellente tenuta alle fuoriuscite d'acqua.

Bisagra con retención para box ducha. Solo tirar. Su diseño envolvente, encierra un mecanismo particularmente robusto. Gracias a la particular forma de la aleta, no se va a cortar el herraje pero asegura un excelente sellado de fugas de agua.

Clicking hinge for shower box pull to open only. Its design hedges in a expecially strong mechanism. Thanks to the particular shape of the

fixing wing it is not required to cut the gasket; it makes an excellent seal against water runoff possible.

Glastürpendelband für Duschen. Nur zum Aufziehen. Sein eigenartiges Design beinhaltet einen besonders robusten Mechanismus. Dank zur eigenartigen Rippeform ist die Dichtungsschnitt vermieidet, ohne Risiko von Wasserverfahren.

Charnière à retenue pour cabine de douche. Son design enveloppant renferme un mécanisme particulièrement robuste. Grâce à la forme particulière de la charnière, il n'est pas nécessaire de couper le joint de douche, ce qui permet d'assurer une excellente étanchéité.





8560



• Cerniera a scatto per box doccia. Solo a tirare. Stop a 0°-90°.

• Bisagra con retención para box ducha. Solo tirar. Tope a 0°-90°.

• Clicking hinge for shower boxes. Pull to open only. Stop at 0°-90°.

• Duschtürband, nur zum Aufziehen. Feststellung bei 0°+90°.

• Charnière à retenue pour cabine de douche. Tirer pour ouvrir. Arrêt à 0° et 90°.

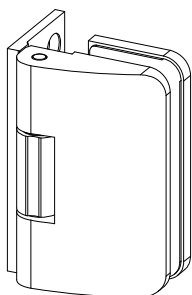

* • È necessaria una battuta in chiusura in quanto la cerniera ha una precarica. • Necesita de un cierre con tope, puesto que la bisagra tiene una precarica. • The hinge has a loading and it is therefore necessary a closing stop. • Eine Schließfeststellung ist notwendig, weil das Scharnier eine mechanische Belastung hat. • La charnière a une charge, il est donc nécessaire d'avoir un arrêt de fermeture.

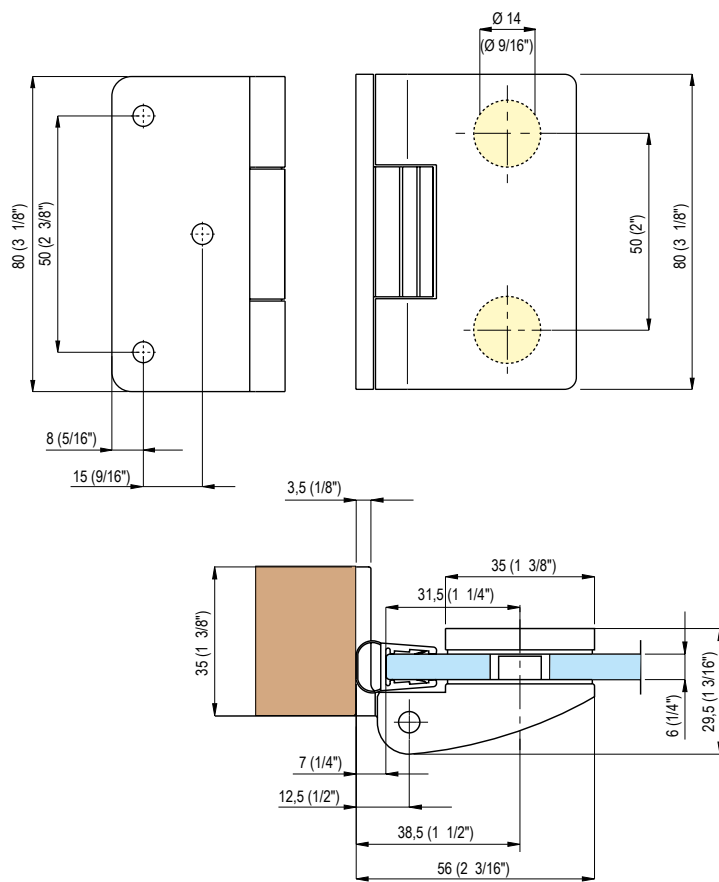

8565



• Cerniera a scatto vetro-vetro 180° per box doccia. Solo a tirare. Stop a 0°-90°.

• Bisagra con retención vidrio-vidrio 180° para box ducha. Solo tirar. Tope a 0°-90°.

• Clicking hinge glass to glass for shower boxes 180°. Pull to open only. Stop at 0°-90°.

• Duschtürband Glas-Glas, 180°, nur zum Aufziehen. Feststellung bei 0°+90°.

• Charnière à retenue verre-verre 180° pour cabine de douche. Tirer pour ouvrir. Arrêt à 0°et 90°.

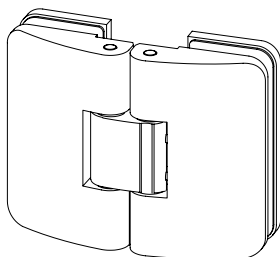

* • È necessaria una battuta in chiusura in quanto la cerniera ha una precarica. • Necesita de un cierre con tope, puesto que la bisagra tiene una precarica. • The hinge has a loading and it is therefore necessary a closing stop. • Eine Schließfeststellung ist notwendig, weil das Scharnier eine mechanische Belastung hat. • La charnière a une charge, il est donc nécessaire d'avoir un arrêt de fermeture.

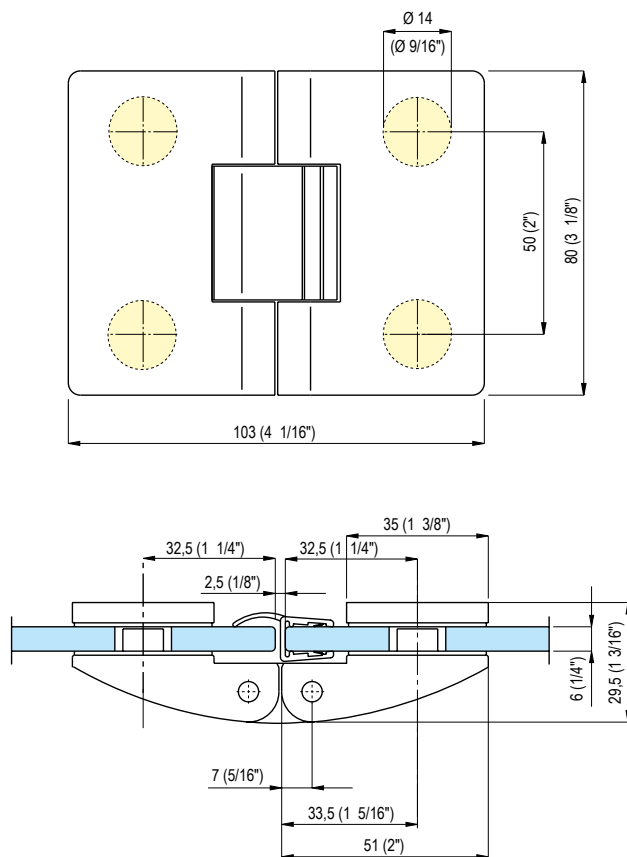

8566



• Cerniera a scatto vetro-vetro 90° per box doccia. Solo a tirare. Stop a 0° 90°.

• Bisagra con retención vidrio-vidrio 90° para box ducha. Solo tirar. Tope a 0° 90°.

• Clicking hinge glass to glass for shower boxes 90°. Pull to open only. Stop at 0° 90°.

• Duschtürband Glas-Glas, 90°, nur zum Aufziehen. Feststellung bei 0°+90°.

• Charnière à retenue verre-verre 90° pour cabine de douche. Tirer pour ouvrir. Arrêt à 0°et 90°.

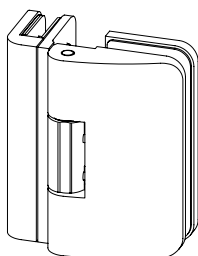

* • È necessaria una battuta in chiusura in quanto la cerniera ha una precarica. • Necesita de un cierre con tope, puesto que la bisagra tiene una precarica. • The hinge has a loading and it is therefore necessary a closing stop. • Eine Schließfeststellung ist notwendig, weil das Scharnier eine mechanische Belastung hat. • La charnière a une charge, il est donc nécessaire d'avoir un arrêt de fermeture.

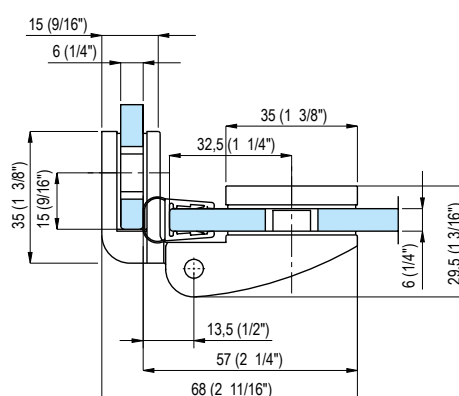
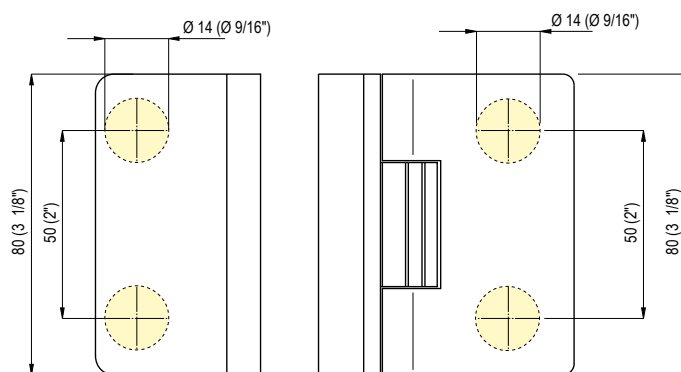

8567

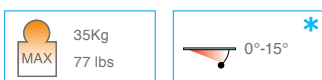

• Cerniera a scatto vetro-vetro 135° per box doccia. Solo a tirare. Stop a 0° 90°.

• Bisagra con retención vidrio-vidrio 135° para box ducha. Solo tirar. Tope a 0° 90°.

• Clicking hinge glass to glass for shower boxes 135°. Pull to open only. Stop at 0° 90°.

• Duschtürband Glas-Glas, 135°, nur zum Aufziehen. Feststellung bei 0°+90°.

• Charnière à retenue verre-verre 135° pour cabine de douche. Tirer pour ouvrir. Arrêt à 0°et 90°.

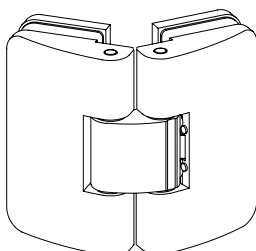

* • È necessaria una battuta in chiusura in quanto la cerniera ha una precarica. • Necesita de un cierre con tope, puesto que la bisagra tiene una precarica. • The hinge has a loading and it is therefore necessary a closing stop. • Eine Schließfeststellung ist notwendig, weil das Scharnier eine mechanische Belastung hat. • La charnière a une charge, il est donc nécessaire d'avoir un arrêt de fermeture.

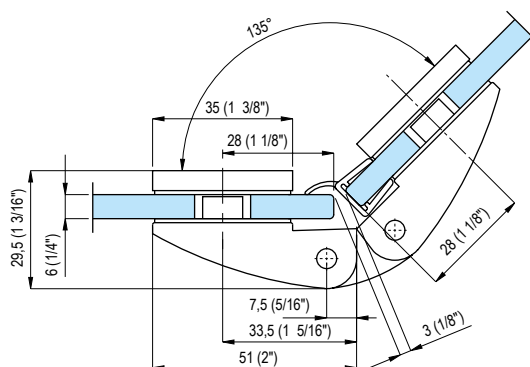
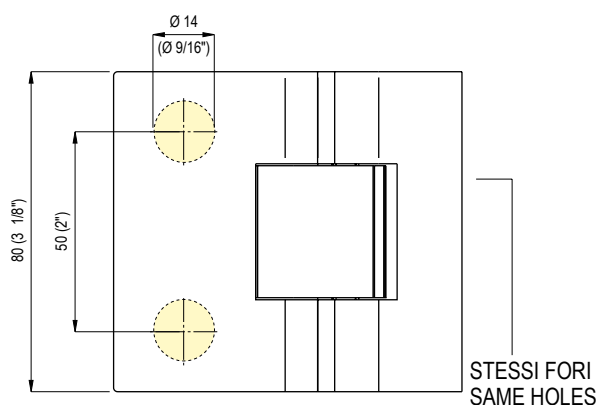

cerniere / hinges
serie **8410**



8410NZN



8411NZN

Zama / Zamak - finiture / colors 13-14-15-60-62

Cerniere vetro-vetro e vetro muro per box doccia, con alzata in apertura. Le dimensioni minime, la grande leggerezza, ne fanno una cerniera particolarmente apprezzata. Il meccanismo permette la chiusura dell'anta con impacchettamento a 180°. Il sistema di alzata abbinato ad una guarnizione specifica, rende ermetica l'applicazione.

Bisagra en la versión vidrio-vidrio y vidrio-pared – para mampara de baño, con elevación en apertura. Tamaños reducidos y ligereza, la hacen agradable. El mecanismo permite el cierre de la puerta a 180°. El alza de la bisagra combinada con un herraje, la pone hermética.

Glass-glass hinges for shower box, with lifting of door at opening. The reduced dimensions and the high lightness make it a very appreciated hinge. The mechanism allows the closing of the shutter with folder at

180°. The lift system combined to a specific gasket makes the application hermetic.

Duschbänder Glas-Glas und Glas-Wand mit Aufhebung der Tür im Laufe der Öffnung. Die geringen Maßen und die Leichtigkeit machen das Band besonders bewert. Der Mechanismus macht es möglich die Tür 180° einzubauen. Das Aufhebungssystem und eine Sonderdichtung machen die Anwendung hermetisch.

Charnières verre-verre et verre-mur pour cabine de douche, avec élévation de la porte à l'ouverture. Ses dimensions réduites et sa légèreté rendent cette charnière particulièrement appréciable. Le mécanisme permet une ouverture de la porte à 180°. Le système de soulèvement combiné à un joint spécifique, rend l'application hermétique.



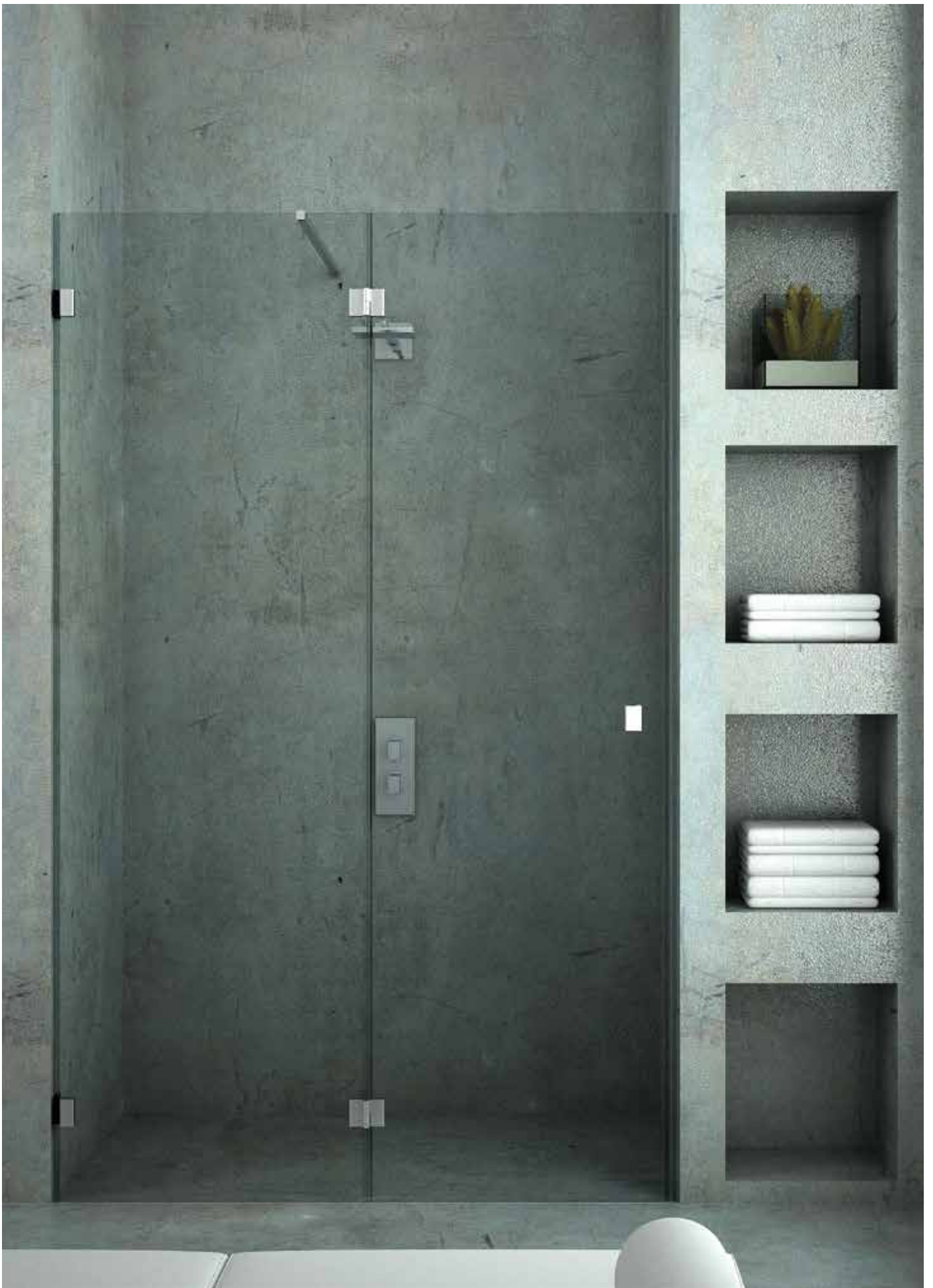

8410NZM

8410NZMR = destra - right
8410NZML = sinistra - left

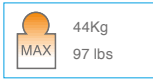
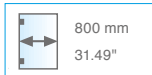
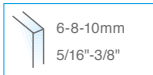

S	A	B	Profilo - Seal
6	7	28.5	8PT8-10
8 (5/16")	6 (1/4")	29.5 (1 5/32")	8PT1-10
10 (3/8")	8 (5/16")	27.5 (1 3/32")	8PT1-10

- Cerniera vetro-muro con alzata in apertura.
- Bisagra vidrio-pared con elevación en apertura.
- Hinge wall to glass with lifting of door at opening.
- Duschtürband Glas-Wand, mit Hebe-Senk-Funktion.
- Charnière mur-verre avec élévation de la porte lors de l'ouverture.

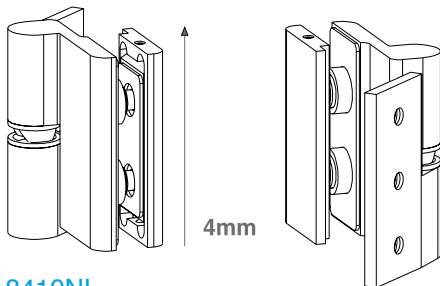

8410NL

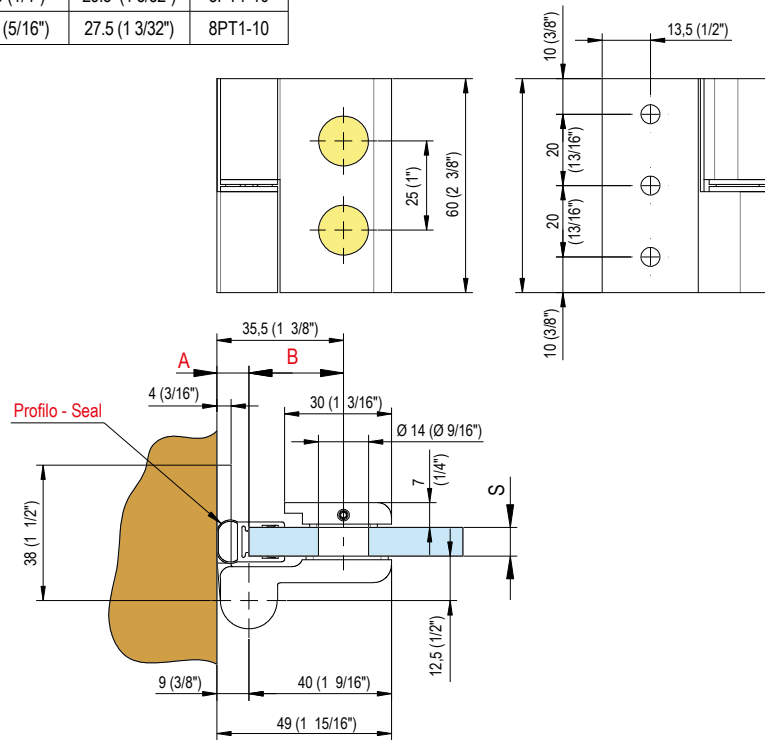

8411NZM

8411NZMR = destra - right
8411NZML = sinistra - left

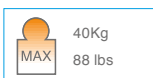
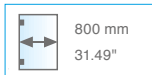
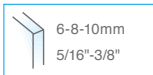

S	A	B	Profilo - Seal
6	3	25	8PT8-30
8 (5/16")	3 (1/8")	25 (31/32")	8PT1-30
10 (3/8")	3 (1/8")	25 (31/32")	8PT1-30

- Cerniera vetro-vetro con alzata in apertura.
- Bisagra vidrio-vidrio con elevación en apertura.
- Hinge glass to glass with lifting of door at opening.
- Duschtürband Glas-Glas, mit Hebe-Senk-Funktion.
- Charnière verre-verre avec élévation de la porte à l'ouverture. Cache pour les vis.

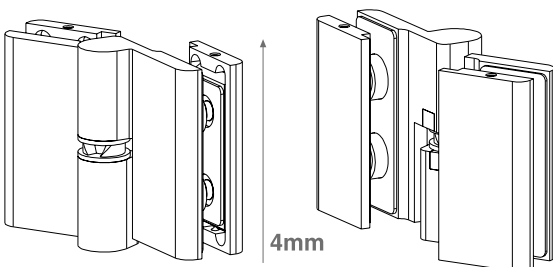

8411NL

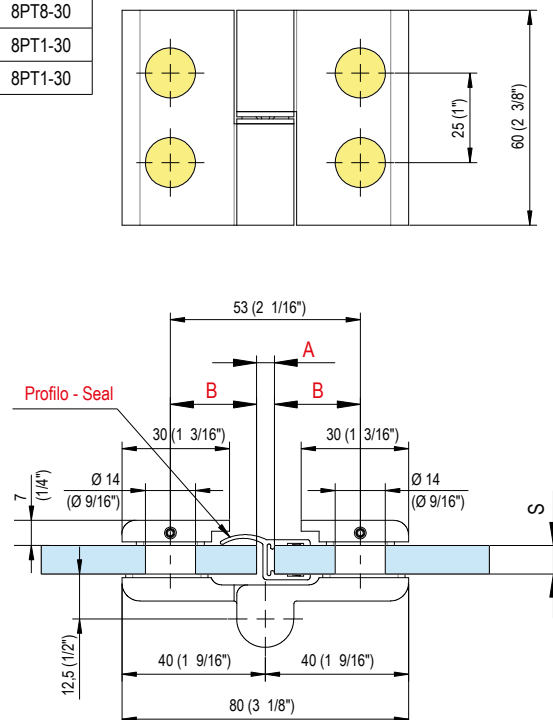

cerniere / hinges serie **8400**



8400



8401

Alluminio / Aluminium - finiture / colors 02-05-13-14-15-16-17-60-62

Cerniere per box doccia disponibili nella versione vetro-muro e vetro-vetro. I fori nel vetro anziché la tacca, le rendono veloci e facili da installare. Design semplice ma armonioso grazie alla forma tonda e alle dimensioni contenute.

Bisagra para mampara de baño, disponible en la versión pared-vidrio y vidrio-vidrio. Los taladros en el vidrio en lugar de la muesca, lo hacen rápido y fácil de instalar. Diseño simple pero armonioso gracias a su forma redondeada y de pequeñas dimensiones.

Hinges for shower enclosures available in version glass-wall and glass-glass. The holes in the glass (instead of cut-out) make them quick and

easy to install. Simple but well-according design thanks to their round shape and the reduced dimensions.

Glastürpendelbänder für Duschtüren in den Varianten Glas-Wand und Glas-Glas. Einfache und schnelle Montage durch Glasbohrungen statt Glaseinschnitte. Schlichtes aber harmonisches Design dank zu dem runden Form und den geringen Maßen.

Charnières pour cabine de douche, disponibles en version verre-mur et verre-verre. L'encoche simplifiée permet une installation rapide. Le design est simple mais harmonieux grâce à sa forme ronde et ses dimensions réduites.



8400

6-8-10mm
5/16"-3/8"

800 mm
31.49"

MAX 44Kg
97 lbs

- Cerniera per box doccia.
- Bisagra para box ducha.
- Hinge for shower boxes.
- Duschtürband.
- Charnière pour cabine de douche.

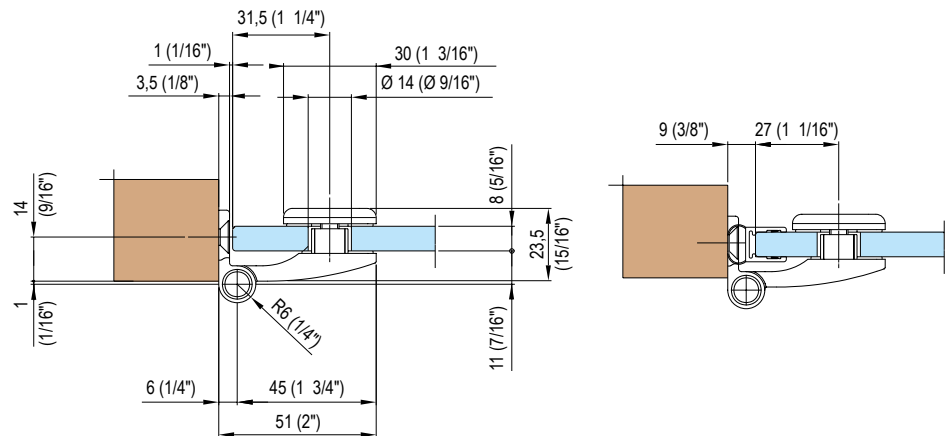
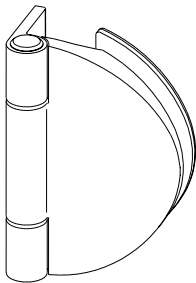
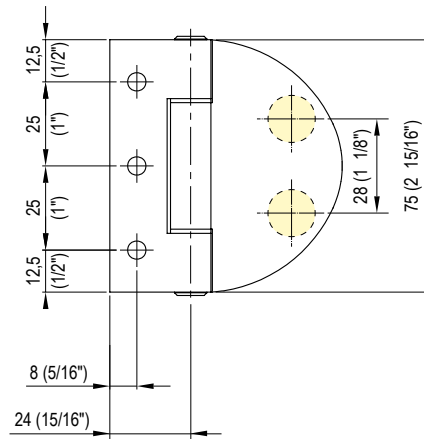

8401

6-8-10mm
5/16"-3/8"

800 mm
31.49"

MAX 40Kg
88 lbs

- Cerniera vetro-vetro per box doccia 135° - 180°.
- Bisagra vidrio-vidrio 135° - 180°, para box ducha.
- Glass to glass clicking hinge 135°-180°.
- Duschtürband, Glas-Glas, 135°-180°.
- Charnière verre-verre pour cabine de douche 135° - 180°.

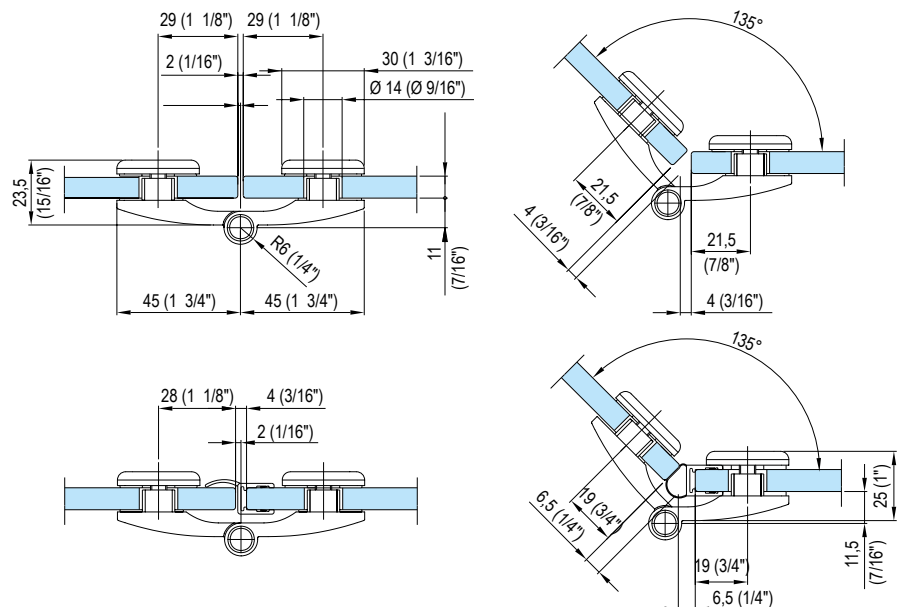
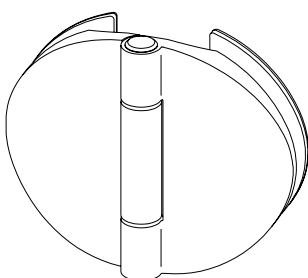
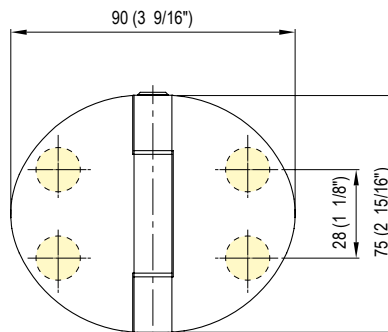

sistema oleodinamico / oildynamic system

kit SLASH



Alluminio / Aluminium - finiture / colors 47

Slash è il primo sistema per box doccia con apertura pivottante e sistema oleodinamico incorporato che consente la chiusura automatica dell'anta. La sua porta ha un'anta battente con il solo telaio superiore e un perno inferiore, che consente di realizzare molteplici soluzioni di box doccia. Il sistema oleodinamico interno con cerniera salvaspazio, permette un passaggio d'ingresso in doccia molto ampio ed un ingombro esterno ridotto. La porta si chiude automaticamente, in modo dolce e controllato, garantendo così massima funzionalità e sicurezza (nella versione SOL il movimento è libero).

Slash es el primer sistema de box ducha con abertura basculante y sistema oleodinámico incorporado; permite el cierre automático de la hoja. La puerta es con tope; la hoja se fija al marco por arriba y al perno por abajo. Este se le permite crear múltiples soluciones de box ducha. El sistema hidráulico con bisagra "ahorra espacio", permite un gran acceso a la ducha y menor dimensiones externas. La puerta se cierra de manera automática, suave y controlada, garantizando así la máxima funcionalidad y seguridad (en la versión SOL el movimiento es libre).

Slash is the first shower enclosure system which combines a pivot door with an integrated hydraulic self-closing system. The complete system consists of an upper bar and a bottom pivot hinge only, it allows a wide range of different installation possibilities. The integrated space-saving hydraulic system facilitates a wide and easy shower en-

trance. The door closes automatically in a gentle and controlled way, providing maximum functionality and safety (the SOL version features free movement).

Slash ist das erste System für Duschen mit Schwenköffnung und integriertem Hydrauliksystem, das die Selbstschließung der Duschtür ermöglicht. Die Drehtür verfügt nur über einen Mechanismus im oberen Rahmen und einen unteren Drehzapfen, die verschiedene Installationsmöglichkeiten der Dusche erlauben. Das integrierte Hydrauliksystem mit raumsparenden Beschlägen, ermöglicht eine breite Öffnung zur Dusche, gleichzeitig wird der externe Bereich nicht eingeschränkt. Die Tür schließt sich automatisch, sanft und kontrolliert und garantiert somit maximale Funktionalität und Sicherheit (in der SOL Version ist die Bewegung frei).

Le Slash est le premier système pour cabine de douche avec ouverture pivotante et système hydraulique intégré qui permet la fermeture automatique de la porte. L'encadrement supérieur de la porte et le pivot bas permettent de réaliser de grandes cabines de douche en coin, avec ou sans panneaux latéraux fixes en verre. Le système hydraulique assure une fermeture douce et contrôlée de la porte, garantissant ainsi performance maximale et sécurité (dans la version SOL, le mouvement est libre). L'ouverture pivotante offre un gain d'espace et un passage large.





D05E30N

oildynamic
pivot system

D05E30SOL

free version
without stop

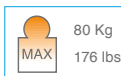
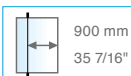

SLASH oildynamic pivot system

• Kit Slash per box doccia in nicchia a tutta larghezza. Stop +90°.

• Kit Slash para box ducha de nicho a anchura total. Stop a +90°.

• Slash niche set wall-wall. One door. Stop at 90°.

• Set Slash für Duschnische Wand-Wand. Eine Tür. +90° Feststellung.

• Kit Slash pour cabine de douche en niche. 1 porte. Arrêt à +90°.

Da specificare all'ordine - Especificar en el pedido - Specify at time of order
Bitte mit der Bestellung genau angeben - Préciser lors de la commande



D05E30N/08

D05E30SOL/08

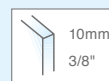

D05E30N/10

D05E30SOL/10

Compresso / Included

OILDYNAMIC
VERSION



D05E P16 (1X)



D05E P11N/08 (1X)

(vetro/glass 8mm)

D05E P11N/10 (1X)

(vetro/glass 10mm)

FREE
VERSION



D05E P16SOL
(1X)



D05E P11SOL/08 (1X)

(vetro/glass 8mm)

D05E P11SOL/10 (1X)

(vetro/glass 10mm)



D05E P12N/08 (1X)

(vetro/glass 8mm)

D05E P12N/10 (1X)

(vetro/glass 10mm)



D05E P30N
(1X)



D05E P47N
(1X)



D05E P90
(2X)

Non compreso / Not included



D05E P40/13 (1,25 mt)

L ≤ 1300mm (630mm MIN)

D05E P40/18 (1,75 mt)

L > 1300mm (1800mm MAX)

(1X)



D05E P55N/13 (1,3 mt)

L ≤ 1300mm (630mm MIN)

D05E P55N/18 (1,8 mt)

L > 1300mm (1800mm MAX)

(1X)



D05E P45/09

(0,9 mt)

(1X) L ≤ 900mm

(2X) L > 900mm



D05E P50N

(1X)

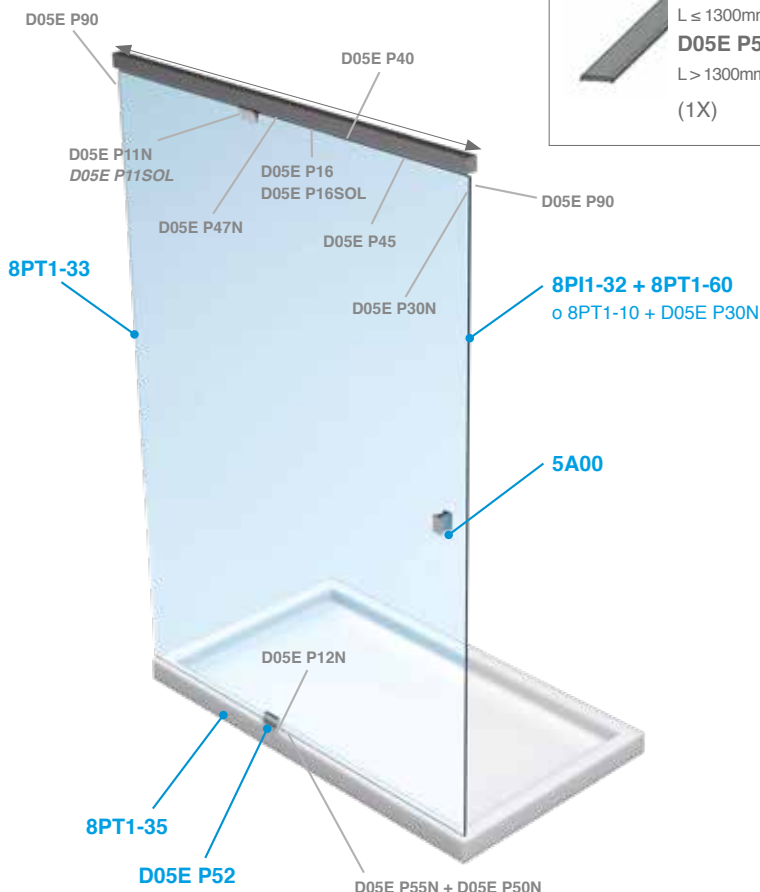

OPTIONAL

Coperture inox per - Cubiertas de acero inoxidable para - Stainless steel covers for - Abdeckungen aus Edelstahl für - Couvertures inox pour

D05E P40



C D05E P40/13

C D05E P40/18

(1X)

D05E P90



C D05E P90

(1X)

Profilo deviatore antisciacchiamento - Perfil desviador anti aplastamiento - Seal against finger crush
Fingerklemmschutzprofil - Joint anti-pincement



8PT1-33

(1X)



D05E P52

(1X)

D05E30N

D05E30SOL

SLASH system

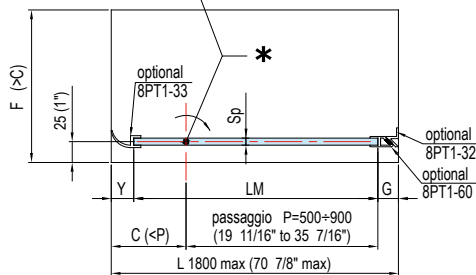
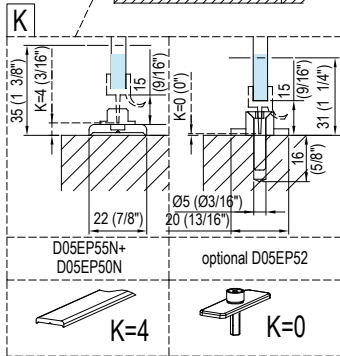
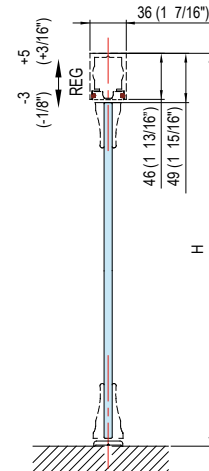
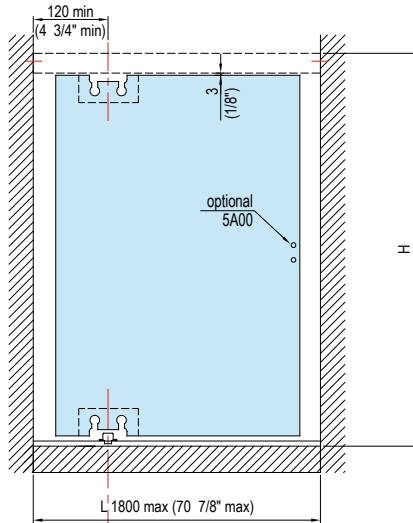
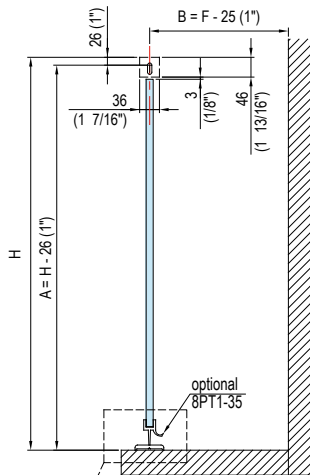

* CENTRO DI ROTAZIONE
ROTATION POINT

Sp	Y	G
8 (5/16")	18 (23/32")	17 (21/32")
10 (3/8")	18 (23/32")	20 (25/32")

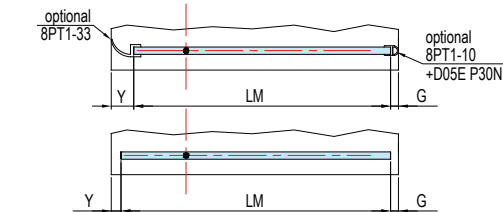

Sp	Y	G
8 (5/16")	18 (23/32")	6 (1/4")
10 (3/8")	18 (23/32")	8 (5/16")

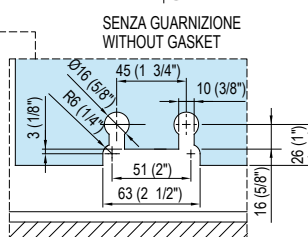
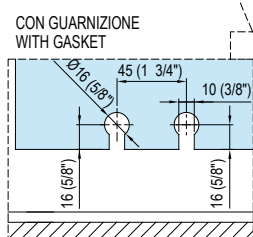
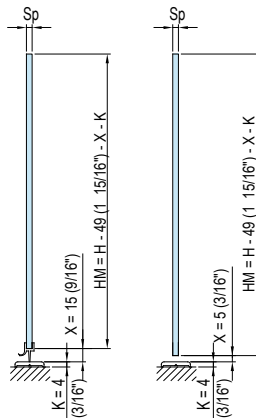
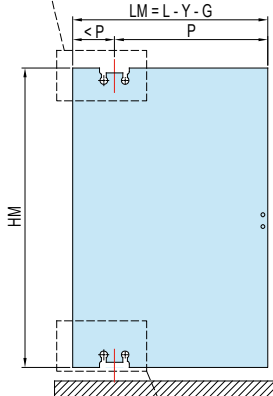
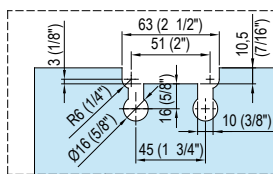

Sp	Y	G
8 (5/16")	3 (1/8")	3 (1/8")
10 (3/8")	3 (1/8")	3 (1/8")

D05E32N

oildynamic
pivot system

D05E32SOL

free version
without stop

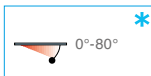
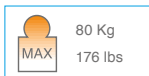
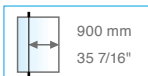

SLASH oildynamic pivot system

• Kit Slash per box doccia in nicchia con vetro fisso frontale. Stop a +90°.

• Kit Slash para box ducha de nicho con vidrio delantero fijo. Stop a +90°.

• Slash niche set wall-wall. 1 door and 1 fixed panel. Stop at 90°.

• Set Slash für Duschnische Wand-Wand. Eine Tür und ein Seitenteil. +90° Feststellung.

• Kit Slash pour cabine de douche en niche. 1 porte et 1 panneau fixe en verre. Arrêt à 90°.

È necessaria una battuta in chiusura in quanto la cerniera ha una precarica - Necesita de un cierre con tope, puesto que la bisagra tiene una precarga - The hinge is preloaded which makes an end stop necessary - Ein Anschlag ist notwendig, da der Beschlag eine Vorspannung besitzt - La charnière a une charge, il est donc nécessaire d'avoir un arrêt de fermeture.

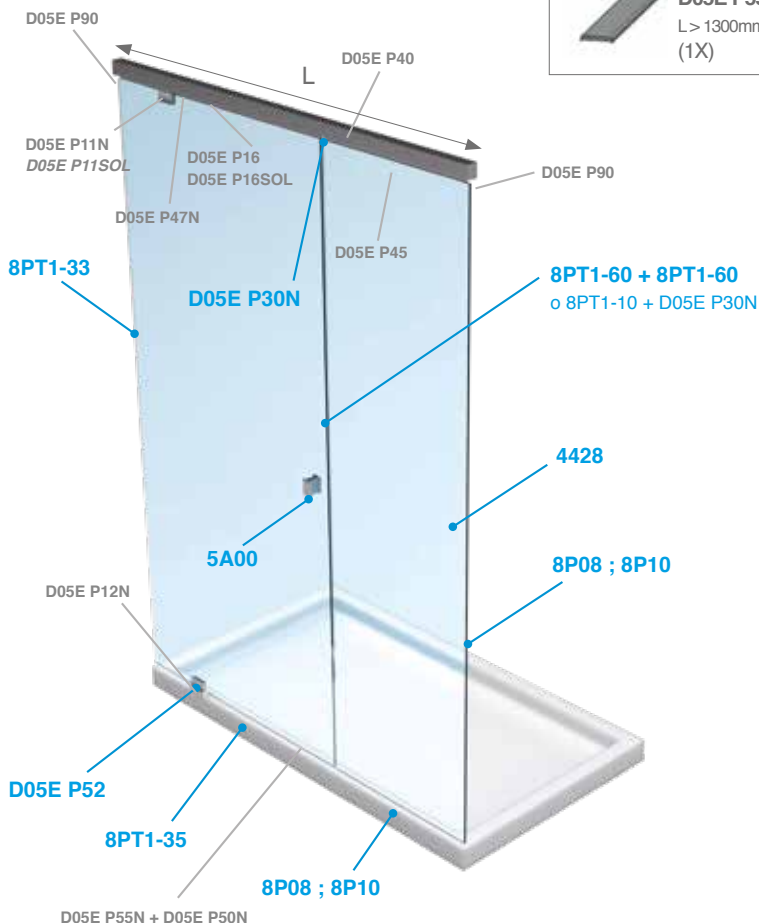

Da specificare all'ordine - Especificar en el pedido - Specify at time of order
Bitte mit der Bestellung genau angeben - Préciser lors de la commande



D05E32N/08

D05E32SOL/08

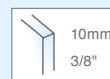

D05E32N/10

D05E32SOL/10

Compresso / Included

OILDYNAMIC
VERSION



D05E P16 (1X)



D05E P11N/08 (1X)

(vetro/glass 8mm)

D05E P11N/10 (1X)

(vetro/glass 10mm)

FREE
VERSION



D05E P16SOL (1X)



D05E P11SOL/08 (1X)

(vetro/glass 8mm)

D05E P11SOL/10 (1X)

(vetro/glass 10mm)



D05E P12N/08 (1X)

(vetro/glass 8mm)

D05E P12N/10 (1X)

(vetro/glass 10mm)



D05E P47N (1X)



D05E P90 (2X)

Non compreso / Not included



D05E P40/13 (1,25 mt)

L ≤ 1300mm (630mm MIN)

D05E P40/18 (1,75 mt)

L > 1300mm (1800mm MAX)

(1X)



D05E P55N/13 (1,3 mt)

L ≤ 1300mm (630mm MIN)

D05E P55N/18 (1,8 mt)

L > 1300mm (1800mm MAX)

(1X)



D05E P45/09

(0,9 mt)

(1X) L ≤ 900mm

(2X) L > 900mm



D05E P50N

(1X)

OPTIONAL

Coperture inox per - Cubiertas de acero inoxidable para - Stainless steel covers for - Abdeckungen aus Edelstahl für - Couverture inox pour



D05E P40

C D05E P40/13

C D05E P40/18

(1X)

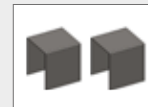

D05E P90

C D05E P90

(1X)

Profilo deviatore antischiacciamento - Perfil desviador anti aplastamiento - Seal against finger crush Fingerklemmschutzprofil - Joint anti-pincement



8PT1-33

(1X)

Fermo - Tope - Endanschlag - Stop



D05E P30N

(1X)



D05E P52

(1X)

D05E32N

D05E32SOL

SLASH system

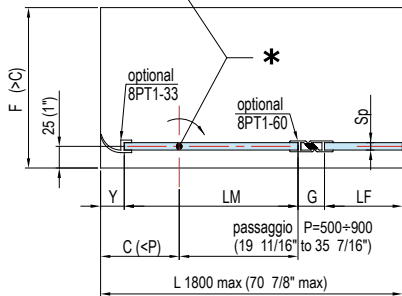
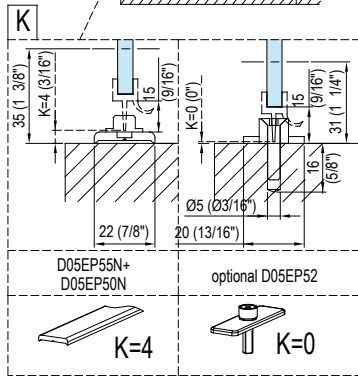
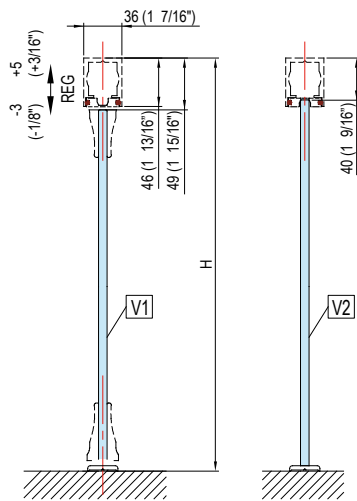
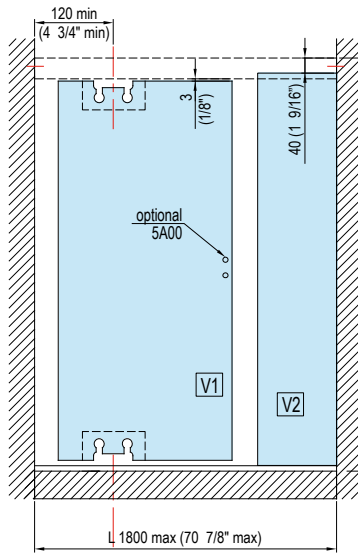
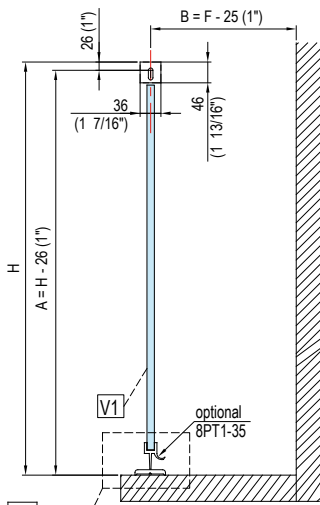

* CENTRO DI ROTAZIONE ROTATION POINT

Sp	Y	G
8 (5/16")	18 (23/32")	22 (7/8")
10 (3/8")	18 (23/32")	26 (1 1/32")

Sp	Y	G
8 (5/16")	18 (23/32")	6 (1/4")
10 (3/8")	18 (23/32")	8 (5/16")

Sp	Y	G
8 (5/16")	3 (1/8")	3 (1/8")
10 (3/8")	3 (1/8")	3 (1/8")

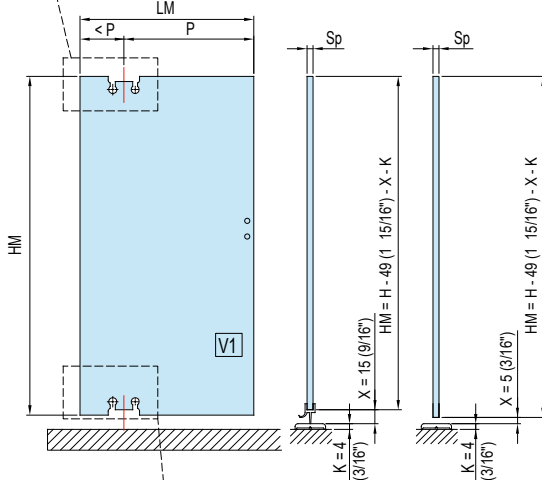
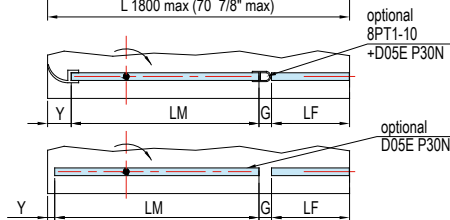
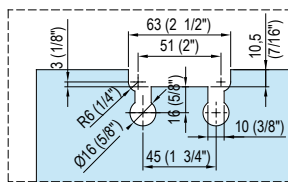

*
Definire il passaggio P voluto.
Valutare il centro di rotazione e
definire la larghezza LM totale.

Definir el pasaje P deseado. El
centro de la vuelta de evaluar y
definir el ancho total LM.

Define the desired passage P.
Consider the rotation point and
define the total width LM.

Den gewünschte Durchgang P
definieren. Auf den Drehpunkt
achten und die Gesamtbreite LM
definieren.

Définir le passage P souhaité.
Évaluer le centre de rotation et
définir la largeur LM totale.

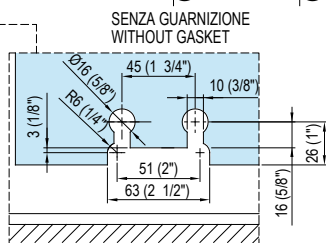
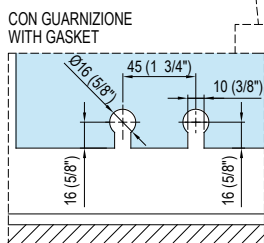
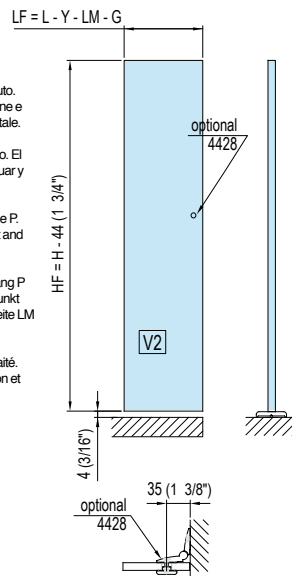

D05E60N

oildynamic
pivot system

D05E60SOL

free version
without stop

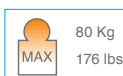

SLASH *oildynamic pivot system*

• Kit Slash per box doccia con 2 spalle in vetro. Stop a +90°.

• Kit Slash de ducha con 2 paneles traseros en cristal. Stop a +90°.

• Slash set for shower tray glass-glass . One door. Stop at +90°.

• Set Slash für Glas-Glas Dusche. Eine Tür. Feststellung +90°.

• Kit Slash avec 2 panneaux en verre et une porte. Arrêt à +90°.

*

È necessaria una battuta in chiusura in quanto la cerniera ha una precarica - Necesita de un cierre con tope, puesto que la bisagra tiene una precarga - The hinge is preloaded which makes an end stop necessary - Ein Anschlag ist notwendig, da der Beschlag eine Vorspannung besitzt - La charnière a une charge, il est donc nécessaire d'avoir un arrêt de fermeture.

Da specificare all'ordine - Especificar en el pedido - Specify at time of order
Bitte mit der Bestellung genau angeben - Préciser lors de la commande



D05E60N/08

D05E60SOL/08

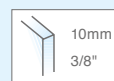

D05E60N/10

D05E60SOL/10

Compresso / Included

OILDYNAMIC
VERSION



D05E P16 (1X)



D05E P11N/08 (1X)

(vetro/glass 8mm)

D05E P11N/10 (1X)

(vetro/glass 10mm)

FREE
VERSION



D05E P16SOL
(1X)



D05E P11SOL/08 (1X)

(vetro/glass 8mm)

D05E P11SOL/10 (1X)

(vetro/glass 10mm)

D05E P12N/08 (1X)
(vetro/glass 8mm)

D05E P12N/10 (1X)
(vetro/glass 10mm)



D05E P80
(2X)

D05E P47N (1X)



D05E P30N
(1X)

D05E P90
(2X)

Non compreso / Not included

D05E P40/13 (1,25 mt)
L ≤ 1300mm (630mm MIN)

D05E P40/18 (1,75 mt)
L > 1300mm (1800mm MAX)
(1X)

D05E P55N/13 (1,3 mt)
L ≤ 1300mm (630mm MIN)

D05E P55N/18 (1,8 mt)
L > 1300mm (1800mm MAX)
(1X)

D05E P45/09
(0,9 mt)

(1X) L ≤ 900mm
(2X) L > 900mm

D05E P50N
(1X)

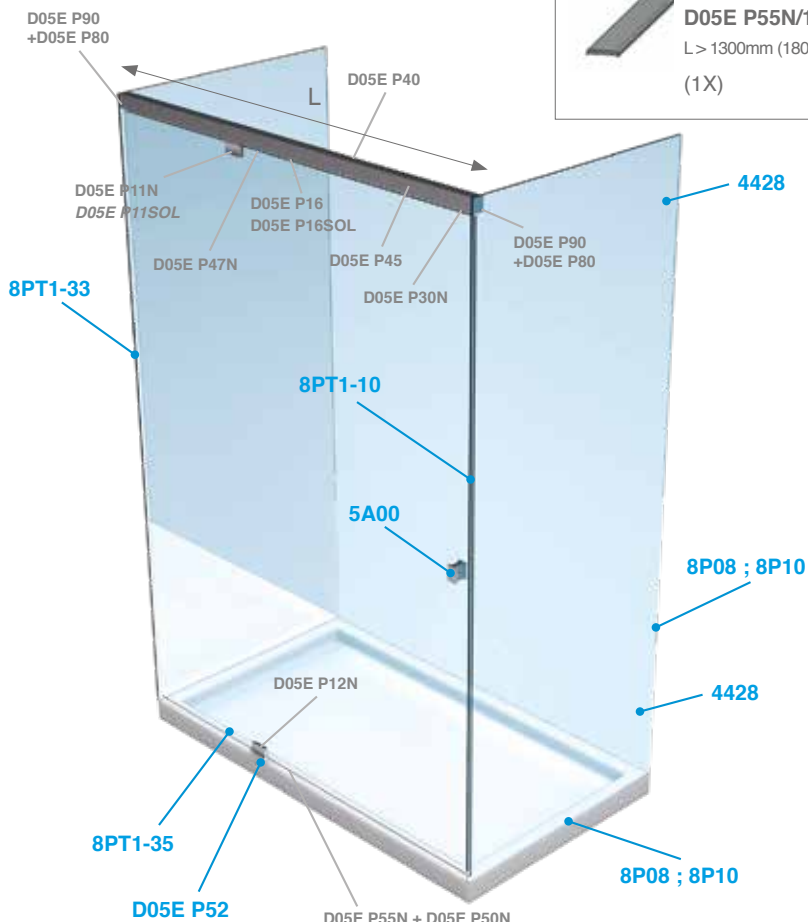

OPTIONAL

Coperture inox per - Cubiertas de acero inoxidable para - Stainless steel covers for - Abdeckungen aus Edelstahl für - Couvertine inox pour

D05E P40

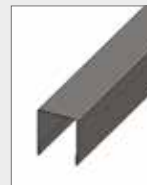

C D05E P40/13
C D05E P40/18
(1X)

D05E P90



C D05E P90
(1X)

Profilo deviatore antischiacciamento - Perfil desviador anti aplastamiento - Seal against finger crush Fingerklemmschutzprofil - Joint anti-pincement



8PT1-33
(1X)



D05E P52
(1X)

D05E60N

D05E60SOL

SLASH system

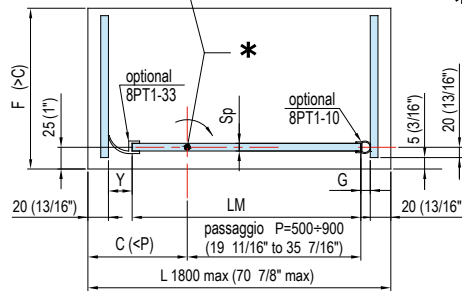
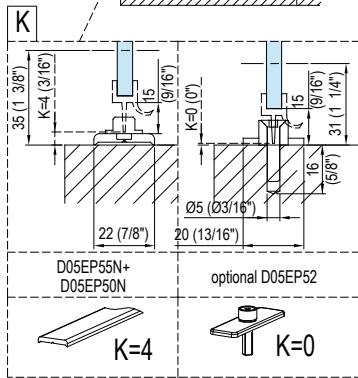
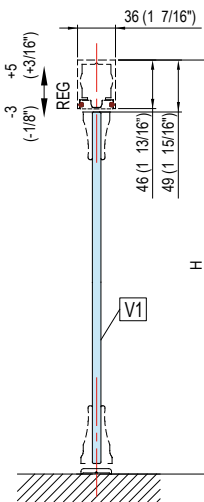
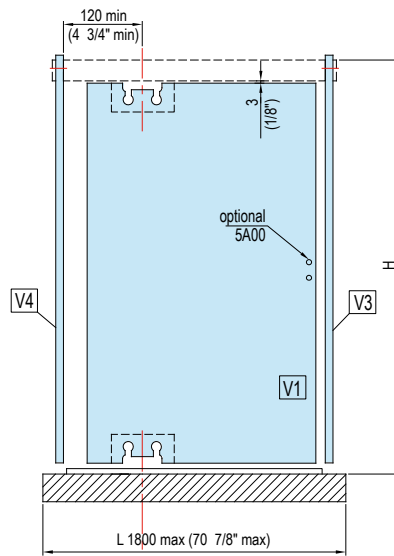
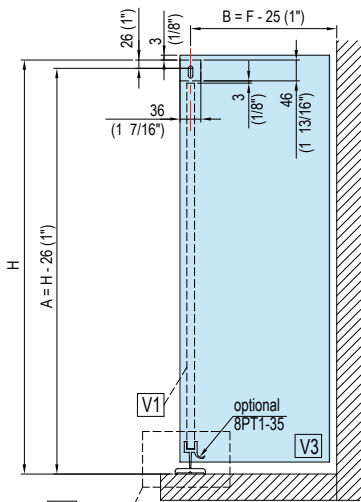

* CENTRO DI ROTAZIONE
PUNTO DE ROTACION
ROTATION POINT
LAGE DER DREHACHSE

Sp	Y	G
8 (5/16")	18 (23/32")	6 (1/4")
10 (3/8")	18 (23/32")	8 (5/16")

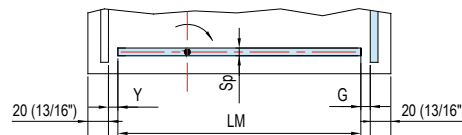
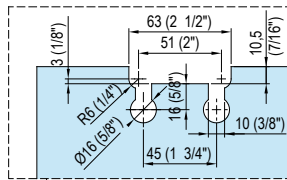

Sp	Y	G
8 (5/16")	3 (1/8")	3 (1/8")
10 (3/8")	3 (1/8")	3 (1/8")

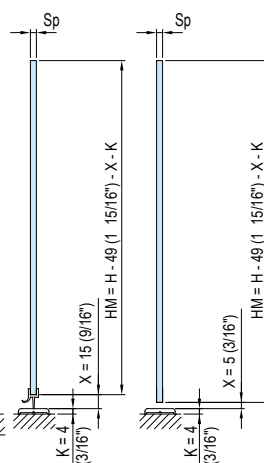
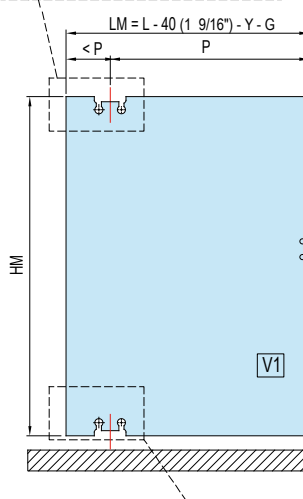

* Definire il passaggio P voluto. Valutare il centro di rotazione e definire la larghezza LM totale.
Definir el pasaje P deseado. Evaluar el centro de la vuelta de evaluar y definir el ancho total LM.
Define the desired passage P. Consider the rotation point and define the total width LM.
Den gewünschte Durchgang P definieren. Auf den Drehpunkt achten und die Gesamtbreite LM definieren.
Définir le passage P souhaité. Evaluer le centre de rotation et définir la largeur LM totale.

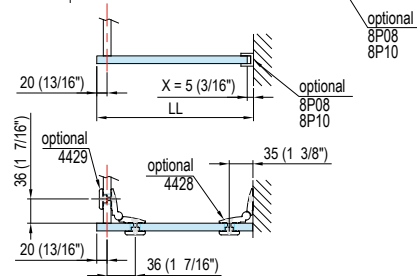
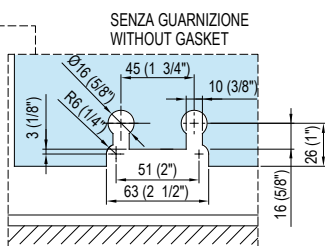
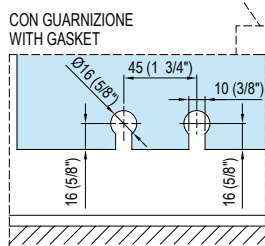
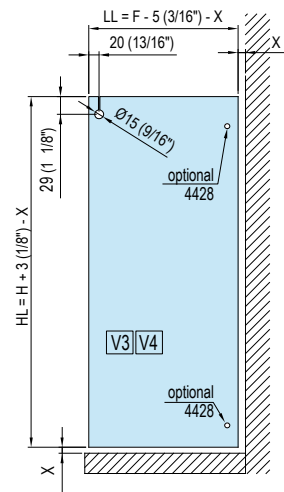

D05E62N

oildynamic
pivot system

D05E62SOL

free version
without stop

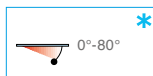
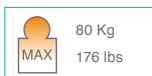
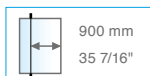

SLASH

oildynamic pivot system

• Kit Slash per box doccia con 2 spalle in vetro. Con vetro fisso frontale. Stop a +90°.

• Kit Slash de ducha con 2 paneles traseros en cristal. Frente de cristal fijo. Stop a +90°.

• Slash set for shower tray glass-glass. One door and fixed glass. Stop at +90°.

• Set Slash für Glas-Glas Dusche. Eine Tür und ein Seitenteil. +90° Feststellung.

• Kit Slash avec une porte, un panneau fixe en verre et deux panneaux fixes latéraux. Arrêt à +90°.

È necessaria una battuta in chiusura in quanto la cerniera ha una precarica - Necesita de un cierre con tope, puesto que la bisagra tiene una precarga - The hinge is preloaded which makes an end stop necessary - Ein Anschlag ist notwendig, da der Beschlag eine Vorspannung besitzt - La charnière a une charge, il est donc nécessaire d'avoir un arrêt de fermeture.

Da specificare all'ordine - Especificar en el pedido - Specify at time of order
Bitte mit der Bestellung genau angeben - Préciser lors de la commande

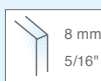

D05E62N/08

D05E62SOL/08

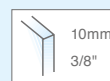

D05E62N/10

D05E62SOL/10

Compresso / Included

OILDYNAMIC
VERSION



D05E P16 (1X)



D05E P11N/08 (1X)
(vetro/glass 8mm)

D05E P11N/10 (1X)
(vetro/glass 10mm)

FREE
VERSION



D05E P16SOL
(1X)



D05E P11SOL/08 (1X)
(vetro/glass 8mm)

D05E P11SOL/10 (1X)
(vetro/glass 10mm)



D05E P12N/08 (1X)
(vetro/glass 8mm)

D05E P12N/10 (1X)
(vetro/glass 10mm)



D05E P47N
(1X)



D05E P80
(2X)



D05E P90
(2X)

Non compreso / Not included



D05E P40/13 (1,25 mt)
L ≤ 1300mm (630mm MIN)

D05E P40/18 (1,75 mt)
L > 1300mm (1800mm MAX)
(1X)



D05E P55N/13 (1,3 mt)
L ≤ 1300mm (630mm MIN)

D05E P55N/18 (1,8 mt)
L > 1300mm (1800mm MAX)
(1X)



D05E P45/09
(0,9 mt)

(1X) L ≤ 900mm
(2X) L > 900mm



D05E P50N
(1X)

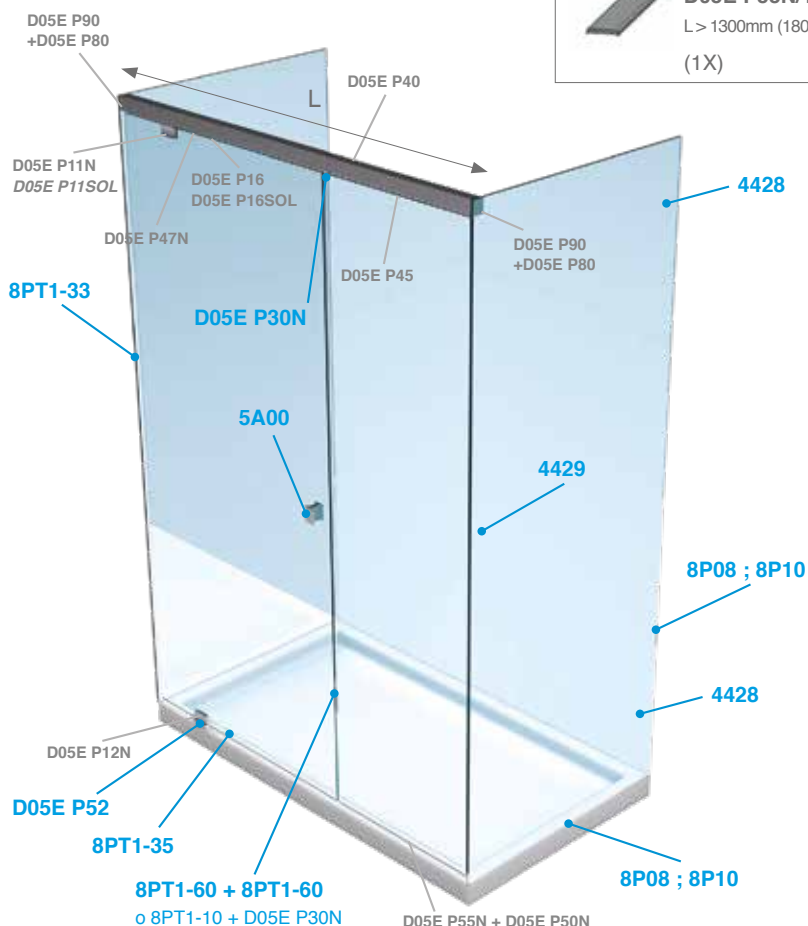

OPTIONAL

Coperture inox per - Cubiertas de acero inoxidable para - Stainless steel covers for - Abdeckungen aus Edelstahl für - Couvertine inox pour



C D05E P40/13
C D05E P40/18
(1X)



C D05E P90
(1X)

Profilo deviatore antisciacchiamento - Perfil desviador anti aplastamiento - Seal against finger crush Fingerklemmschutzprofil - Joint anti-pincement



8PT1-33
(1X)

Fermo - Tope - Stop - Endanschlag



D05E P30N
(1X)



D05E P52
(1X)

D05E62N

D05E62SOL

SLASH system

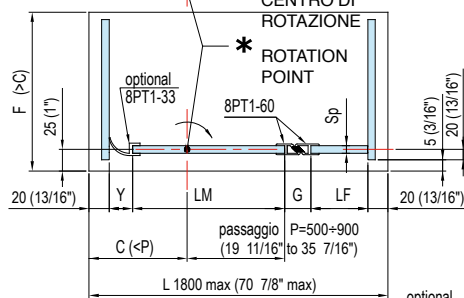
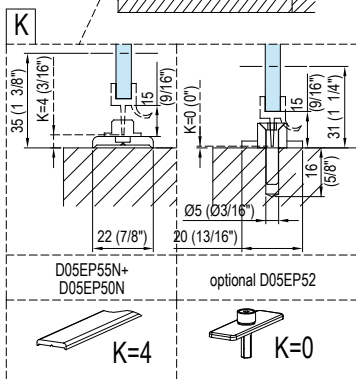
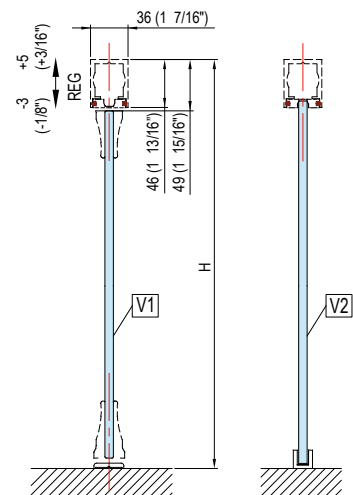
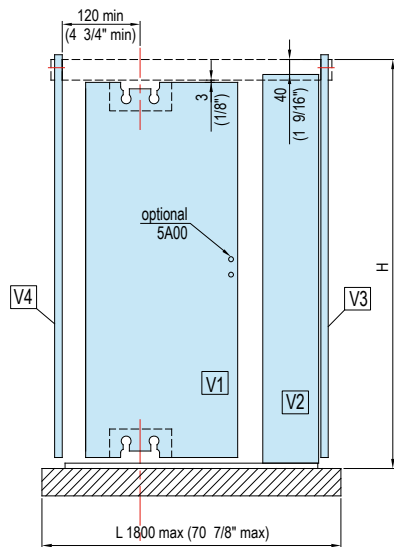
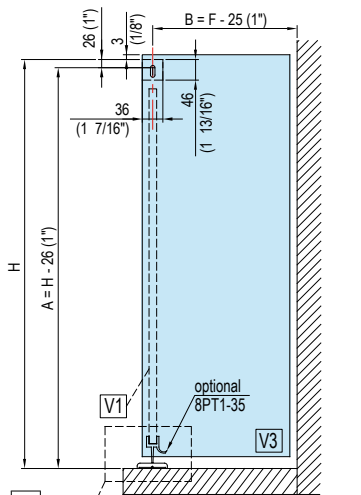

* Definire il passaggio P voluto. Valutare il centro di rotazione e definire la larghezza LM totale.
 Definir el pasaje P deseado. El centro de la vuela de evaluar y definir el ancho total LM.
 Define the desired passage P. Consider the rotation point and define the total width LM.
 Den gewünschte Durchgang P definieren. Auf den Drehpunkt achten und die Gesamtbreite LM definieren.
 Définir le passage P souhaité. Evaluer le centre de rotation et définir la largeur LM totale.

Sp	Y	G
8 (5/16")	18 (23/32")	22 (7/8")
10 (3/8")	18 (23/32")	26 (1 1/32")

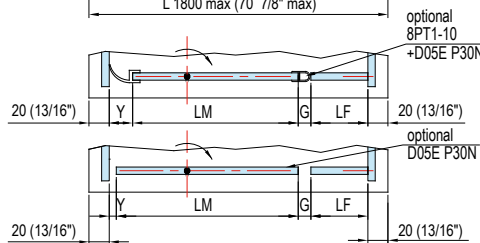

Sp	Y	G
8 (5/16")	18 (23/32")	6 (1/4")
10 (3/8")	18 (23/32")	8 (5/16")

Sp	Y	G
8 (5/16")	3 (1/8")	3 (1/8")
10 (3/8")	3 (1/8")	3 (1/8")

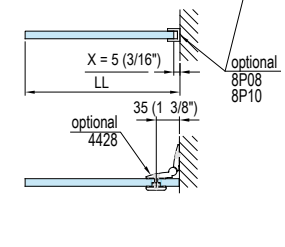
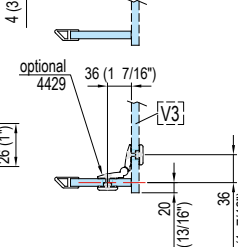
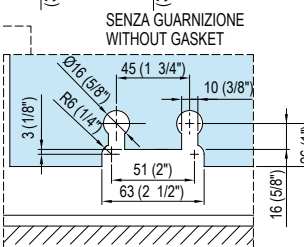
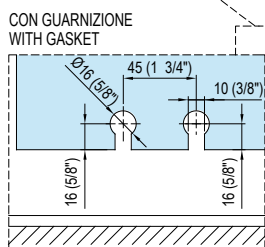
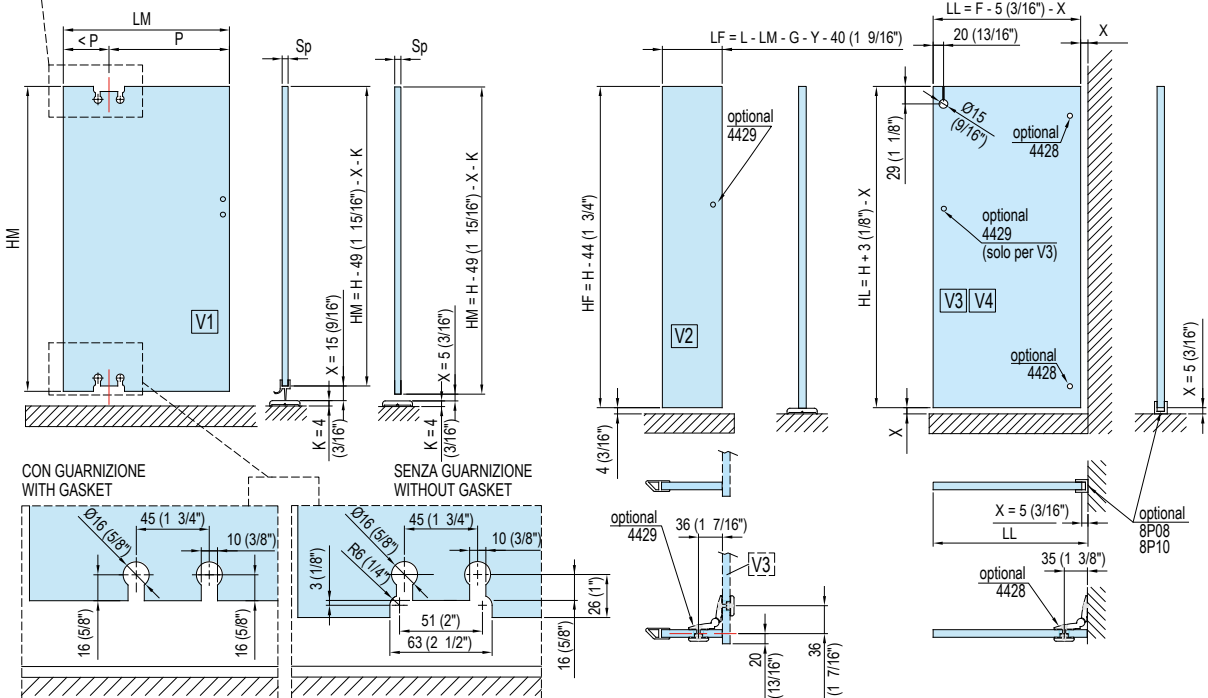
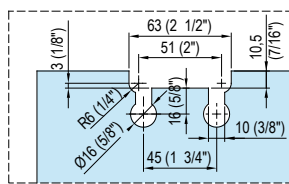

D05E70N

oildynamic
pivot system

D05E70SOL

free version
without stop

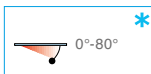
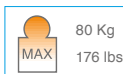
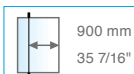

SLASH

oildynamic pivot system

- Kit Slash per box doccia con 1 spalla in vetro. Stop a +90°.
- Kit Slash para box ducha: 1 lado en vidrio. Stop a +90°.
- Set Slash for shower tray wall-glass. One door. Stop at +90°.
- Set Slash für Wand-Glas Dusche. Eine Tür. +90° Feststellung.
- Kit Slash pour cabine de douche avec 1 fixe latéral. Arrêt à +90°.

*

È necessaria una battuta in chiusura in quanto la cerniera ha una precarica - Necesita de un cierre con tope, puesto que la bisagra tiene una precarga - The hinge is preloaded which makes an end stop necessary - Ein Anschlag ist notwendig, da der Beschlag eine Vorspannung besitzt - La charnière a une charge, il est donc nécessaire d'avoir un arrêt de fermeture.

Da specificare all'ordine - Especificar en el pedido - Specify at time of order
Bitte mit der Bestellung genau angeben - Préciser lors de la commande



D05E70N/08

D05E70SOL/08

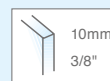

D05E70N/10

D05E70SOL/10

Compresso / Included

OILDYNAMIC
VERSION



D05E P16 (1X)



D05E P11N/08 (1X)
(vetro/glass 8mm)
D05E P11N/10 (1X)
(vetro/glass 10mm)

FREE
VERSION



D05E P16SOL
(1X)



D05E P11SOL/08 (1X)
(vetro/glass 8mm)
D05E P11SOL/10 (1X)
(vetro/glass 10mm)



D05E P12N/08 (1X)
(vetro/glass 8mm)
D05E P12N/10 (1X)
(vetro/glass 10mm)



D05E P47N
(1X)



D05E P80
(1X)



D05E P30N
(1X)



D05E P90
(2X)

Non compreso / Not included



D05E P40/13 (1,25 mt)
L ≤ 1300mm (630mm MIN)
D05E P40/18 (1,75 mt)
L > 1300mm (1800mm MAX)
(1X)



D05E P45/09
(0,9 mt)
(1X) L ≤ 900mm
(2X) L > 900mm



D05E P55N/13 (1,3 mt)
L ≤ 1300mm (630mm MIN)
D05E P55N/18 (1,8 mt)
L > 1300mm (1800mm MAX)
(1X)



D05E P50N
(1X)

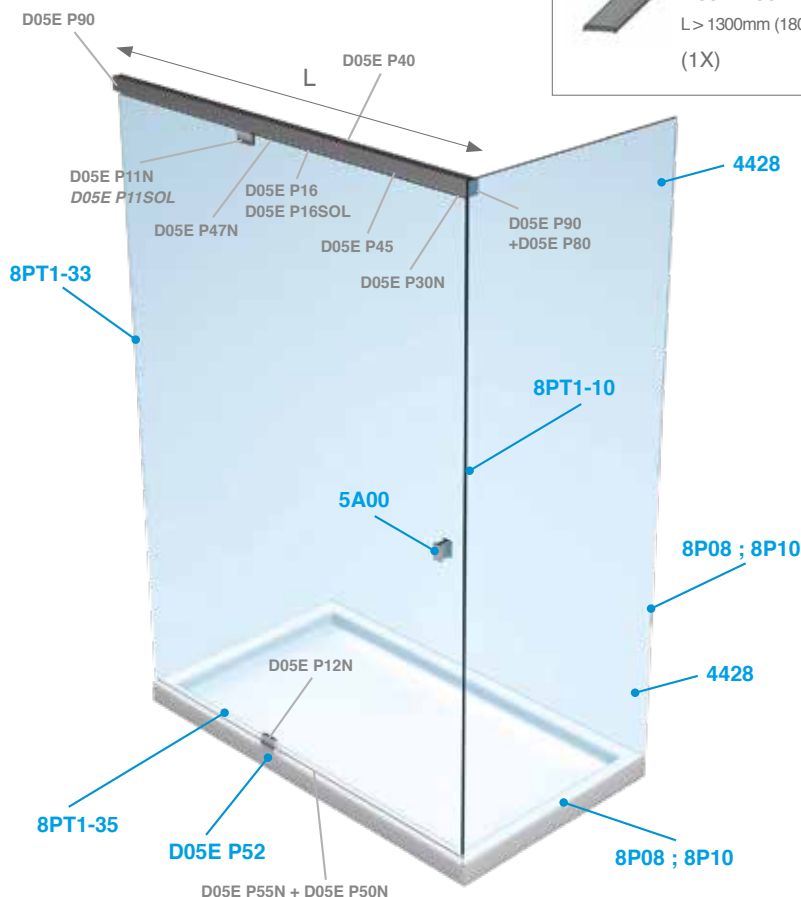

OPTIONAL

Coperture inox per - Cubiertas de acero inoxidable para - Stainless steel covers for - Abdeckungen aus Edelstahl für - Cache inox pour



D05E P40
C D05E P40/13
C D05E P40/18
(1X)



D05E P90
C D05E P90
(1X)

Profilo deviatore antisciacchiamento - Perfil desviador anti aplastamiento - Seal against finger crush
Fingerklemmschutzprofil - Joint anti-pincement



8PT1-33
(1X)



D05E P52
(1X)

D05E70N

D05E70SOL

SLASH system

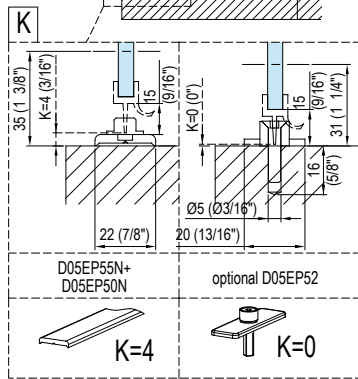
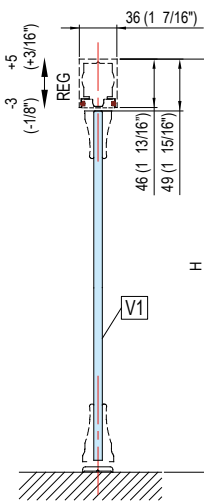
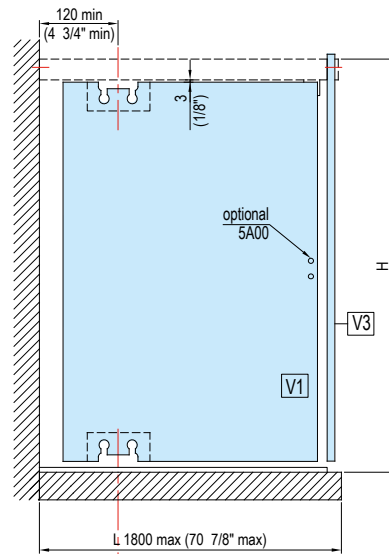
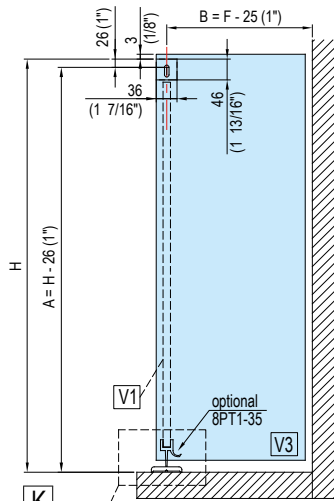

D05EP55N+
D05EP50N

optional D05EP52

K=4

K=0

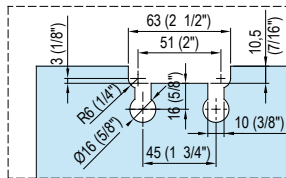

$$LM = L - G - 38 (1 \frac{1}{2} \text{")}$$

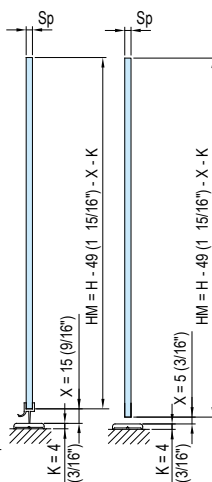
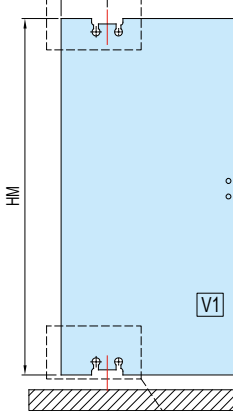
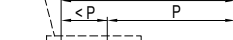

K=4

X = 15 (9/16\"/>

HM = H - 49 (1 15/16\"/>

X = 5 (3/16\"/>

HM = H - 49 (1 15/16\"/>

X = 5 (3/16\"/>

HM = H - 49 (1 15/16\"/>

CON GUARNIZIONE
WITH GASKET

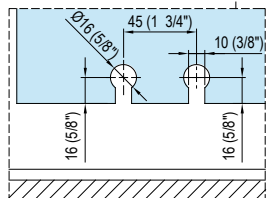

SENZA GUARNIZIONE
WITHOUT GASKET

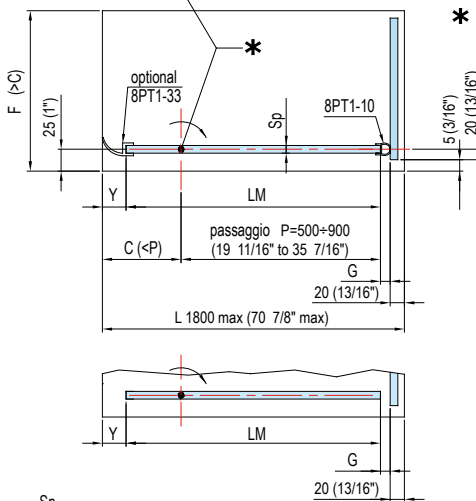
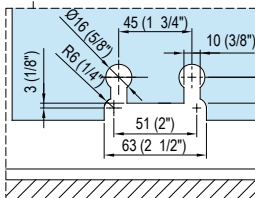

* CENTRO DI ROTAZIONE
ROTATION POINT

Sp	Y	G
8 (5/16")	18 (23/32")	6 (1/4")
10 (3/8")	18 (23/32")	8 (5/16")

Sp	Y	G
8 (5/16")	3 (1/8")	3 (1/8")
10 (3/8")	3 (1/8")	3 (1/8")

*
Definire il passaggio P voluto.
Valutare il centro di rotazione e
definire la larghezza LM totale.

Definir el pasaje P deseado. El
centro de la vuelta de evaluar y
definir el ancho total LM.

Define the desired passage P.
Consider the rotation point and
define the total width LM.

Den gewünschte Durchgang P
definieren. Auf den Drehpunkt
achten und die Gesamtbreite LM
definieren.

Définir le passage P souhaité.
Évaluer le centre de rotation et
définir la largeur LM totale.

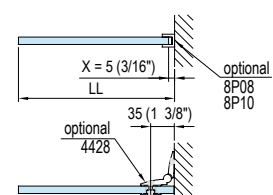
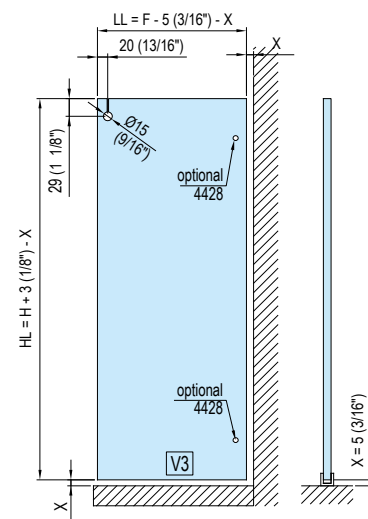

D05E72N

oildynamic
pivot system

D05E72SOL

free version
without stop

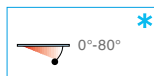
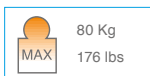
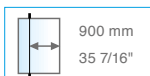

SLASH oildynamic pivot system

• Kit Slash per box doccia con 1 spalla in vetro. Con vetro fisso frontale. Stop a +90°.

• Kit Slash para box ducha: 1 lado en vidrio. Frente de cristal fijo. Stop a +90°.

• Set Slash for shower tray wall-glass. One door and one fixed glass. Stop at +90°.

• Set Slash für Wand-Glas Dusche. Eine Tür und ein Seitenteil. +90° Feststellung.

• Kit Slash pour cabine de douche avec une porte, un panneau fixe en verre et un panneau fixe latéral. Arrêt +90°.

*

È necessaria una battuta in chiusura in quanto la cerniera ha una precarica - Necesita de un cierre con tope, puesto que la bisagra tiene una precarga - The hinge is preloaded which makes an end stop necessary - Ein Anschlag ist notwendig, da der Beschlag eine Vorspannung besitzt - La charnière a une charge, il est donc nécessaire d'avoir un arrêt de fermeture.

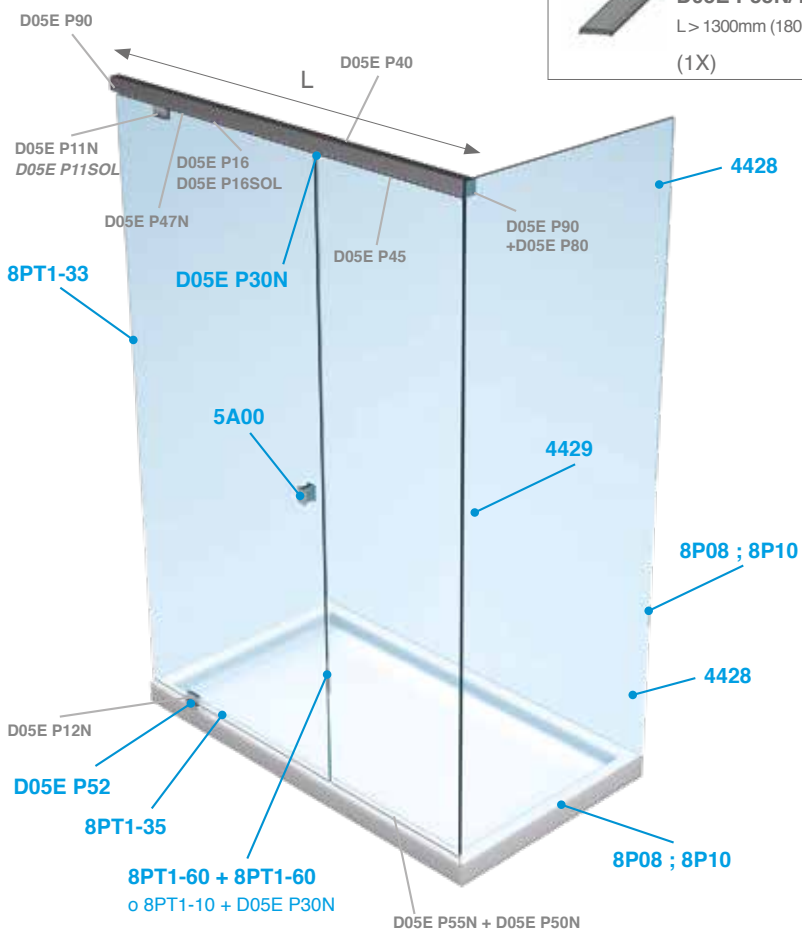

Da specificare all'ordine - Especificar en el pedido - Specify at time of order
Bitte mit der Bestellung genau angeben - Préciser lors de la commande

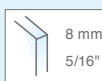

D05E72N/08

D05E72SOL/08

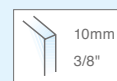

D05E72N/10

D05E72SOL/10

Compresso / Included

OILDYNAMIC
VERSION



D05E P16 (1X)



D05E P11N/08 (1X)
(vetro/glass 8mm)
D05E P11N/10 (1X)
(vetro/glass 10mm)

FREE
VERSION



D05E P16SOL
(1X)



D05E P11SOL/08 (1X)
(vetro/glass 8mm)
D05E P11SOL/10 (1X)
(vetro/glass 10mm)



D05E P12N/08 (1X)
(vetro/glass 8mm)
D05E P12N/10 (1X)
(vetro/glass 10mm)



D05E P47N
(1X)



D05E P80
(1X)



D05E P90
(2X)

Non compreso / Not included



D05E P40/13 (1,25 mt)
L ≤ 1300mm (630mm MIN)

D05E P40/18 (1,75 mt)
L > 1300mm (1800mm MAX)
(1X)



D05E P55N/13 (1,3 mt)
L ≤ 1300mm (630mm MIN)
D05E P55N/18 (1,8 mt)
L > 1300mm (1800mm MAX)
(1X)



D05E P45/09
(0,9 mt)
(1X) L ≤ 900mm
(2X) L > 900mm



D05E P50N
(1X)

OPTIONAL

Coperture inox per - Cubiertas de acero inoxidable para - Stainless steel covers for - Abdeckungen aus Edelstahl für - Couvertine inox pour



D05E P40
C D05E P40/13
C D05E P40/18
(1X)



D05E P90
C D05E P90
(1X)

Profilo deviatore antischiacciamento - Perfil desviador anti aplastamiento - Seal against finger crush
Fingerklemmschutzprofil - Joint anti-pinchment



8PT1-33
(1X)

Fermo - Toppe - Stop - Endanschlag



D05E P30N
(1X)



D05E P52
(1X)

D05E72N

D05E72SOL

SLASH system

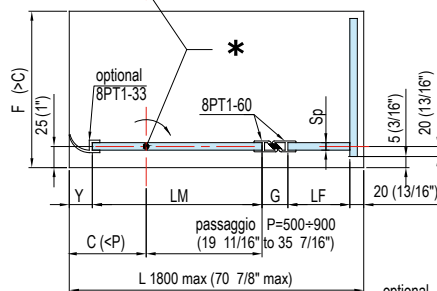
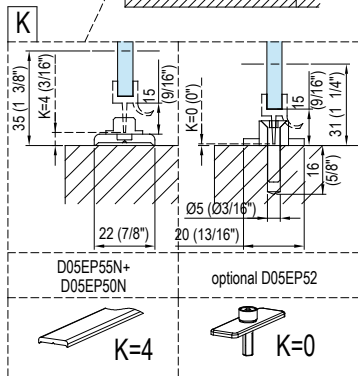
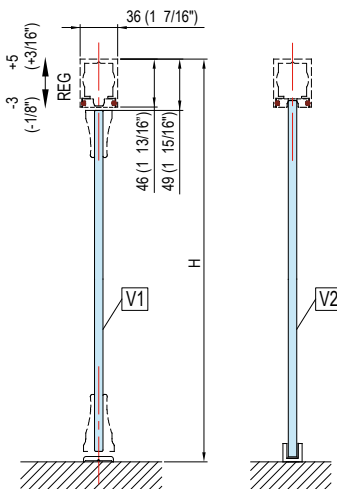
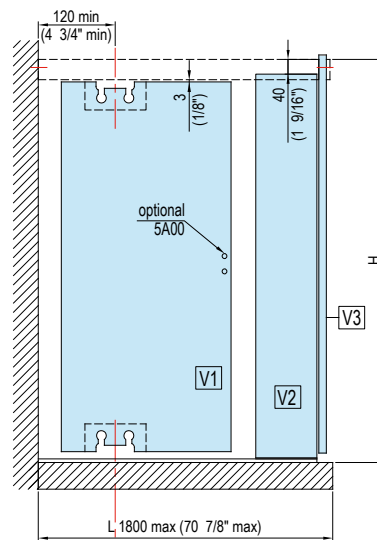
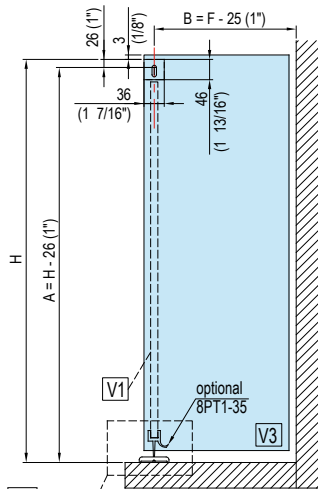

* Definire il passaggio P voluto. Valutare il centro di rotazione e definire la larghezza LM totale.
 Definir el pasaje P deseado. El centro de la vuelta de evaluar y definir el ancho total LM.
 Define the desired passage P. Consider the rotation point and define the total width LM.
 Den gewünschte Durchgang P definieren. Auf den Drehpunkt achten und die Gesamtbreite LM definieren.
 Définir le passage P souhaité. Evaluer le centre de rotation et définir la largeur LM totale.

Sp	Y	G
8 (5/16")	18 (23/32")	22 (7/8")
10 (3/8")	18 (23/32")	26 (1 1/32")

* CENTRO DI ROTAZIONE ROTATION POINT

Sp	Y	G
8 (5/16")	18 (23/32")	6 (1/4")
10 (3/8")	18 (23/32")	8 (5/16")

Sp	Y	G
8 (5/16")	3 (1/8")	3 (1/8")
10 (3/8")	3 (1/8")	3 (1/8")

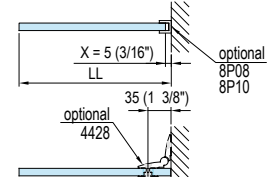
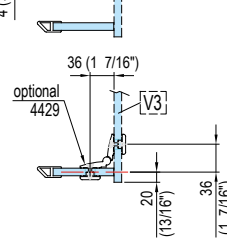
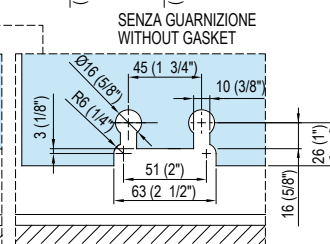
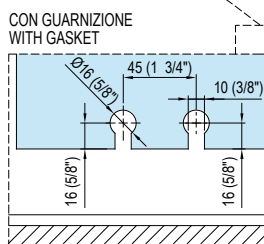
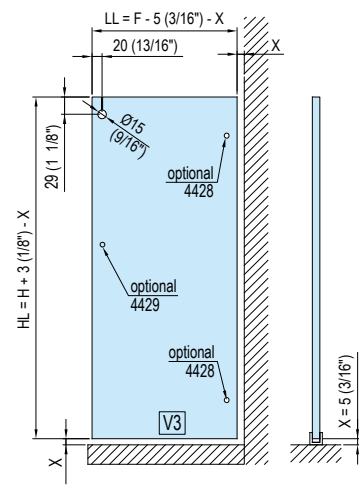
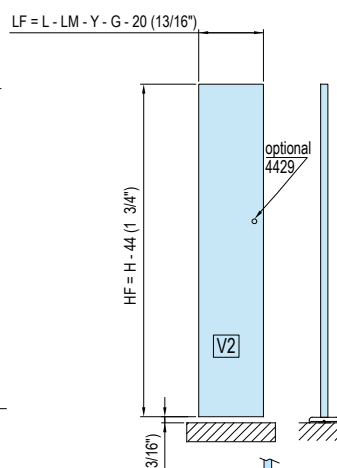
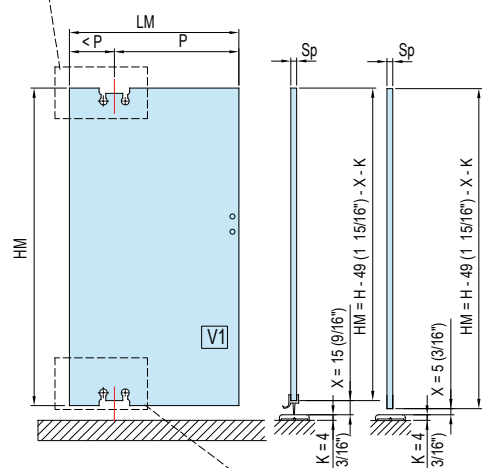
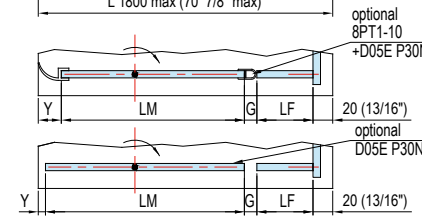
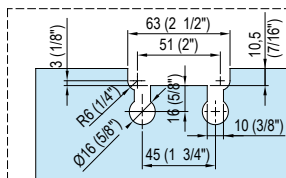

sistemi / systems

kit PIUMA



Sistema scorrevole per box doccia, di design essenziale, linee estetiche pulite, trasparenza ed eleganza. Caratteristica peculiare di Piuma è l'estrema funzionalità: la distanza tra il vetro scorrevole e quello fisso è infatti ridotta al minimo. Piuma si distingue inoltre per la robustezza: dimensioni e pesi non rappresentano più un limite in quanto il kit può sopportare dimensioni e luci vetri molto ampie senza alcun problema di peso o flessione. È adatto a box doccia con spazio di passaggio fino a 85 cm.

Sistema corredero para ducha, de diseño esencial, líneas estéticas limpias, transparencia y elegancia. Una característica especial del Piuma System es su funcionalidad: se reduce al mínimo la distancia entre el fijo y la puerta. Piuma System se distingue por su robustez: dimensiones y pesos ya no representan un problema ya que el kit puede soportar tamaño y peso del vidrio sin ningún problema de peso o de flexión. Adapto a mamparas de baño con un espacio de entrada de 85cm.

Sliding system for shower boxes, simple design, clean aesthetic lines, transparency and elegance. A peculiar characteristic of Piuma is its extreme functionality: the distance between the sliding door and the fixed glazing is reduced to a minimum. Piuma is also robust: dimensions and

weights are no longer a limit because the set can bear large glass sizes without any weight or bending problems. It is suitable for showers with a passage space of up to 85cm.

Schiebetürsystem für Duschkabinen, minimalistischen Designs, klaren ästhetischen Linien, Transparenz und Eleganz. Das charakteristische Merkmal von Piuma ist die extreme Funktionalität: der Abstand zwischen Schiebeflügel und Seitenteil ist auf ein Minimum reduziert. Piuma kennzeichnet sich ferner durch seine Stabilität, so dass größere Flügelabmessungen und Gewichte ohne Durchbiegungsprobleme eingesetzt werden können. Es eignet sich für Duschkabine mit einer Durchgangsbreite bis zu 85 cm.

Un système coulissant pour cabine de douche, au design simple et aux lignes esthétiques et épurées mêlant transparence et élégance. Une particularité du système Piuma est son extrême étanchéité : la distance entre la porte coulissante et le panneau en verre fixe est réduite à son minimum. Piuma se distingue également par sa robustesse : les dimensions et le poids ne sont désormais plus une limite car le kit peut supporter des panneaux en verre large sans aucun problème de poids ni de courbure. Il convient aux cabines de douche avec un espace de passage jusqu'à 85 cm.





D15E00

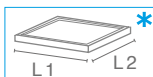
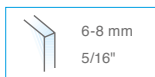

PIUMA system

- Kit Piuma versione ad angolo. Per piatti doccia da 780x780mm fino a 1800x1000mm.
- Kit Piuma en ángulo. Para plato de ducha de 780x780mm hasta 1800x1000mm.
- Piuma corner set. Shower tray size 780x780mm up to 1800x1000mm.
- Beschlagset Piuma für Eckdusche mit Wannenabmessung 780x780mm-1800x1000mm.
- Kit d'angle Piuma. Pour porte de douche de 780x780mm à 1800x1000mm.

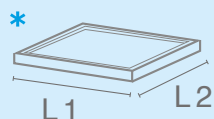

- L1 x L2 min = 780x780mm
- L1 x L2 max = 1800x1000mm
- L1 x L2 > 1800x1000mm (CUSTOM)

Compresso / Included

D15E P10 (2X)

D15E P10S (2X) + D15E P10D (2X)



D15E P20 (1X)



D15E P90S (1X)



D15E P90D (1X)



D15E P30 (2X)

L1, L2 > 900



D15E P50S (1X)



D15E P50D (1X)



D12E J02 (8X)



D12E J53 (4X)



Non compreso / Not included

D15E P40/10 (0,92 mt)

L1, L2 = 780 + 984mm

D15E P40/13 (1,32 mt)

L1, L2 = 985 + 1384mm

D15E P40/18 (1,85 mt)

L1, L2 = 1385 + 1800mm



8PT6-37 Sp.6mm

L = 2200mm



8PT8-37 Sp.8mm

L = 2200mm

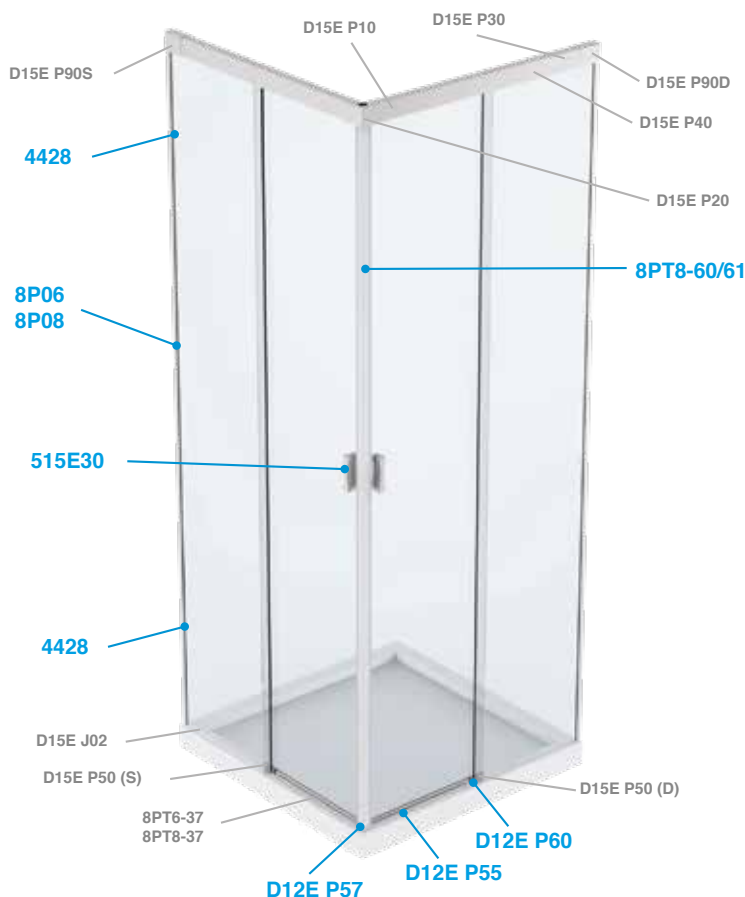

OPTIONAL

Tubolare contenimento acqua e tappi
 Tubo y tapas para contener el agua
 Tubes and caps for water containment
 Wasser abweisendes Rohrprofil und Kappen
 Tubes et connecteurs pour retenue d'eau



D12E P55
 L1, L2 < 900 (1X)
 L1, L2 > 900 (2X)



D12E P57
 (1X)



D12E P60
 (1X)

D15E00

PIUMA system

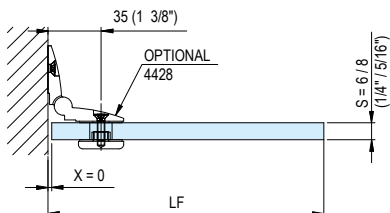
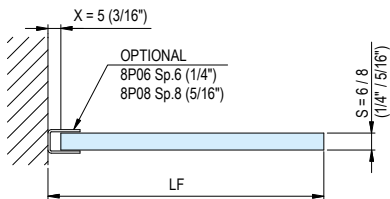
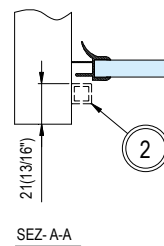
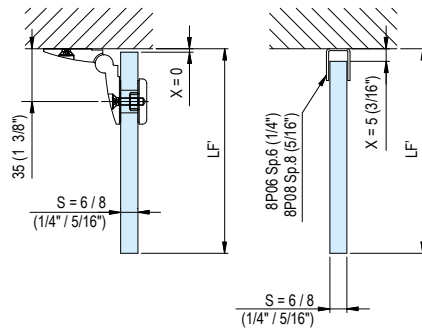
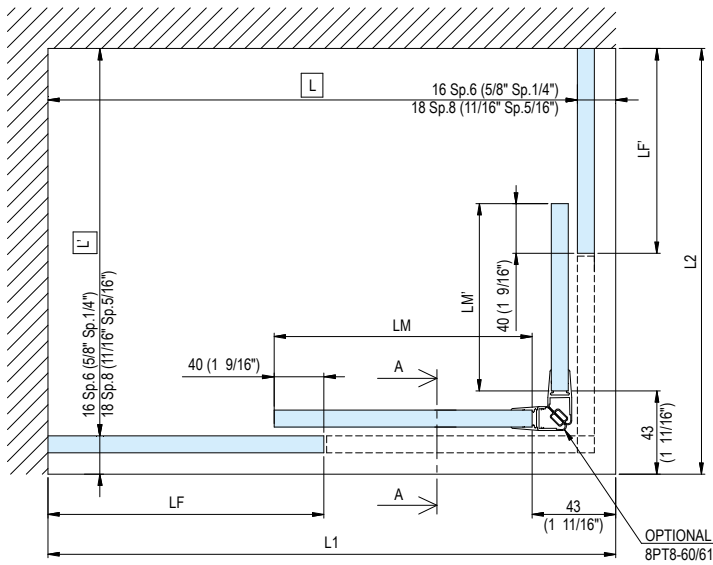
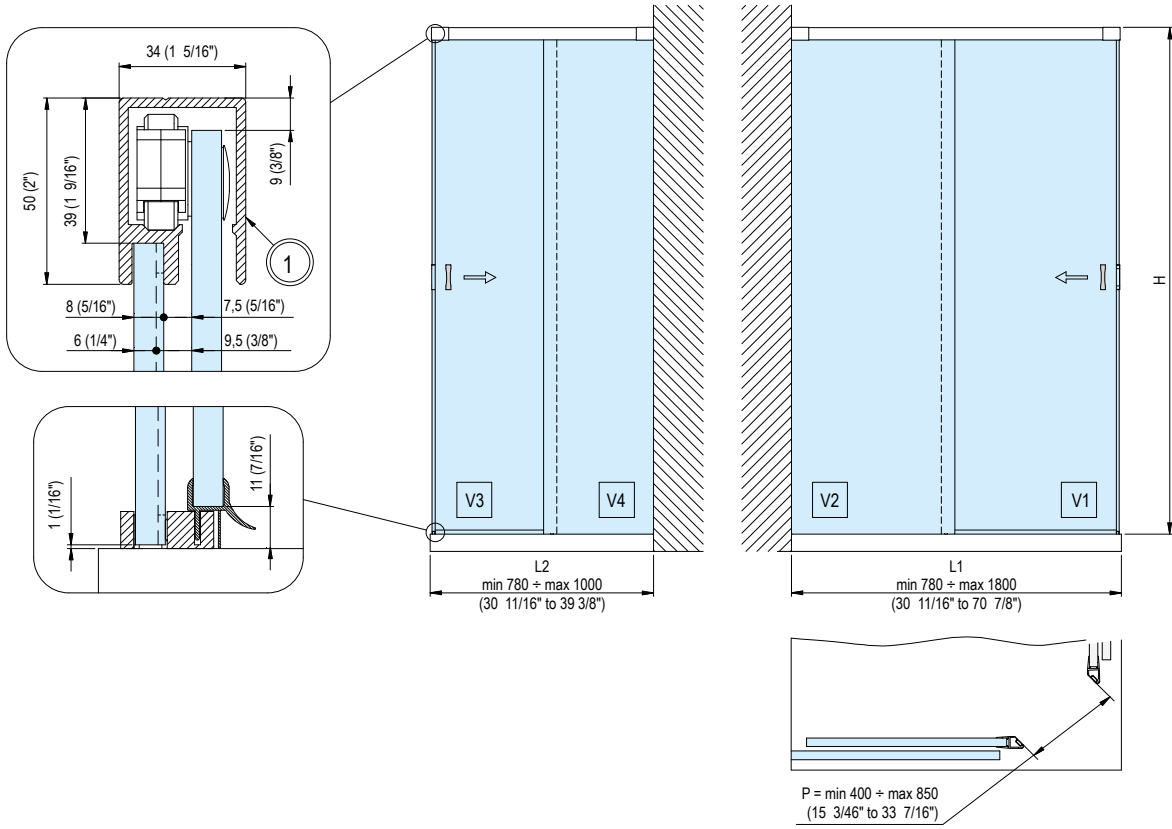

D15E00

PIUMA system

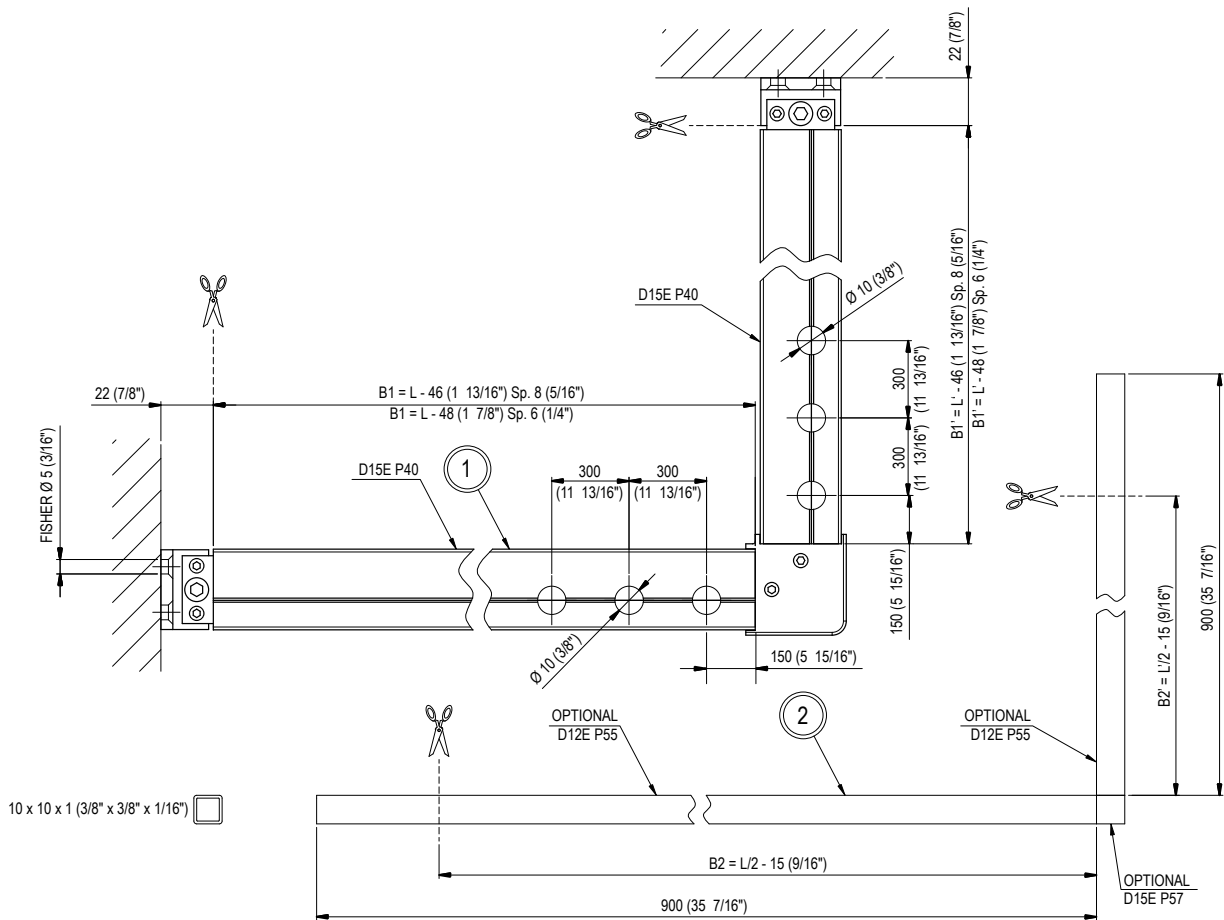
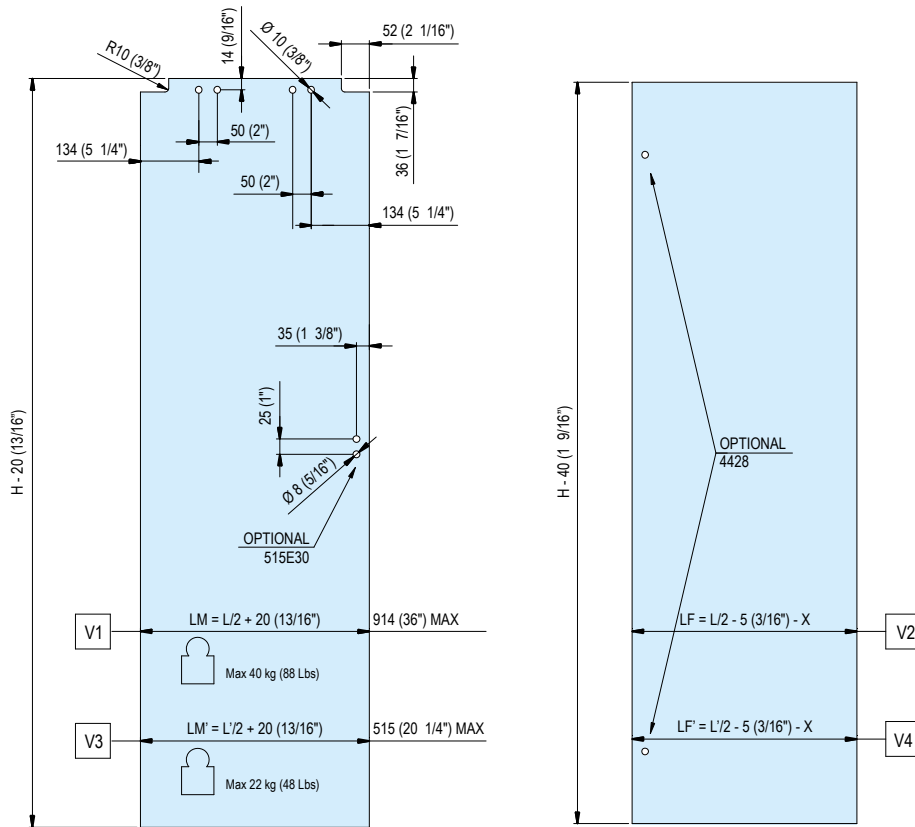

D15E30

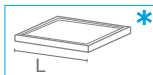
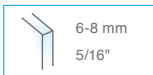

PIUMA system

- Kit Piuma per box doccia in nicchia da 1000 a 1800mm.
- Kit Piuma para mampara de baño fijación a pared de 1000 a 1800mm.
- Piuma niche set from 1000mm to 1800mm.
- Beschlagset Piuma für Nischendusche Wand-Wand mit Länge 1000mm bis 1800mm.
- Kit Piuma pour cabine de douche en niche de 1000 à 1800mm.

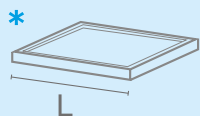

- L min = 1000mm
- L max = 1800mm
- L > 1800mm (CUSTOM)

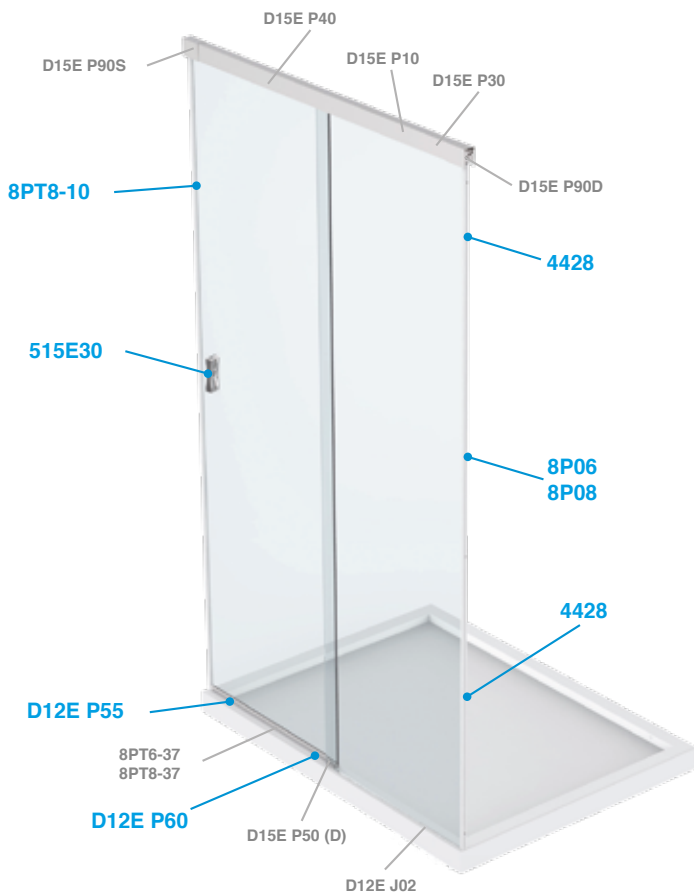

Compresso / Included

D15E P10 (1X)

D15E P10S (1X) + D15E P10D (1X)



D15E P30 (1X)

L > 900



D15E P90S (1X)



D15E P90D (1X)



D12E J02 (8X)



D12E J53 (4X)



Non compreso / Not included

D15E P40/10 (0,92 mt)

L = 780 ÷ 964mm

D15E P40/13 (1,32 mt)

L = 965 ÷ 1364mm

D15E P40/18 (1,85 mt)

L = 1365 ÷ 1894mm

D15E P40/24 (2,4 mt)

L > 1895 ÷ 2444mm (CUSTOM)



8PT6-37 Sp.6mm

L = 2200mm



8PT8-37 Sp.8mm

L = 2200mm



D15E P50S (1X)



D15E P50D (1X)

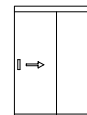

OPTIONAL

Tubolare contenimento acqua e tappi
 Tubo y tapas para contener el agua
 Tubes and caps for water containment
 Wasser abweisendes Rohrprofil und Kappen
 Tubes et connecteurs pour retenue d'eau



D12E P55
(1X)



D12E P60
(1X)

D15E30

PIUMA system

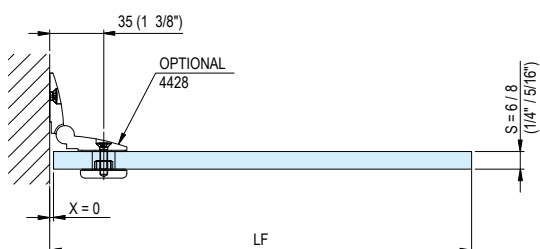
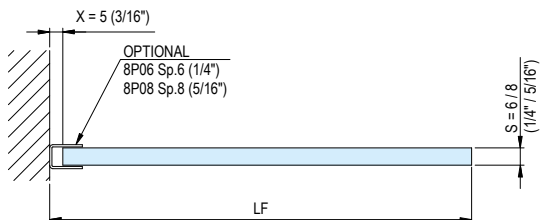
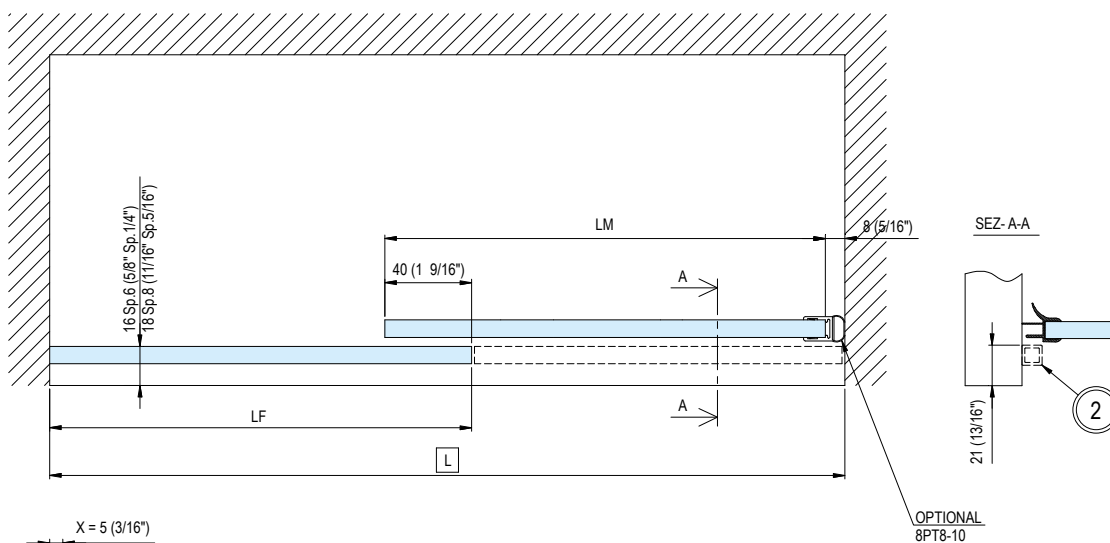
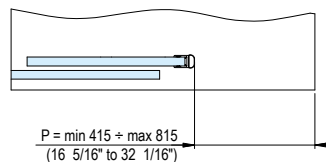
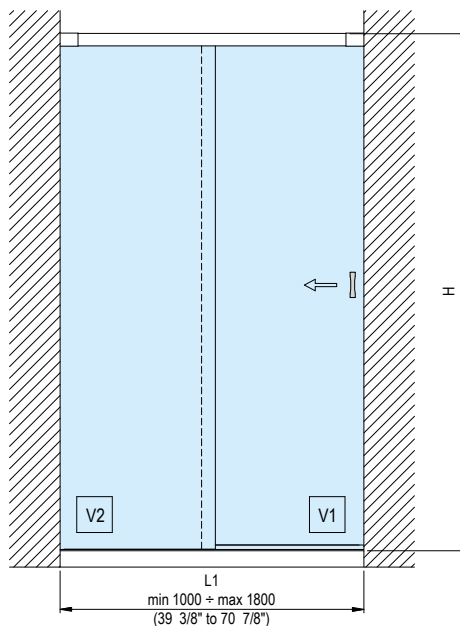
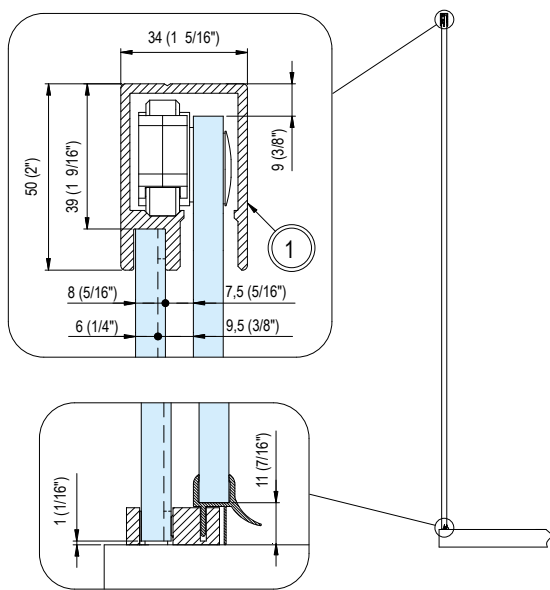

D15E30

PIUMA system

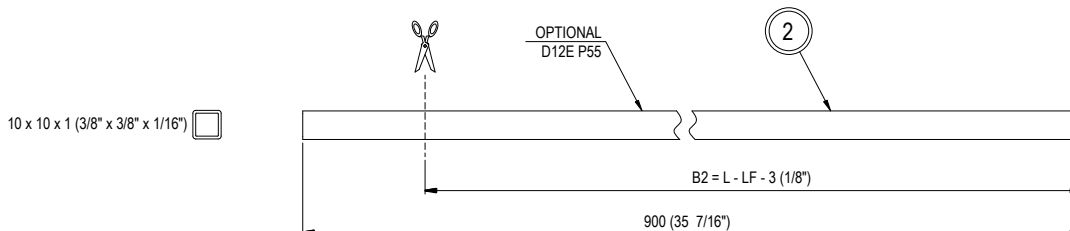
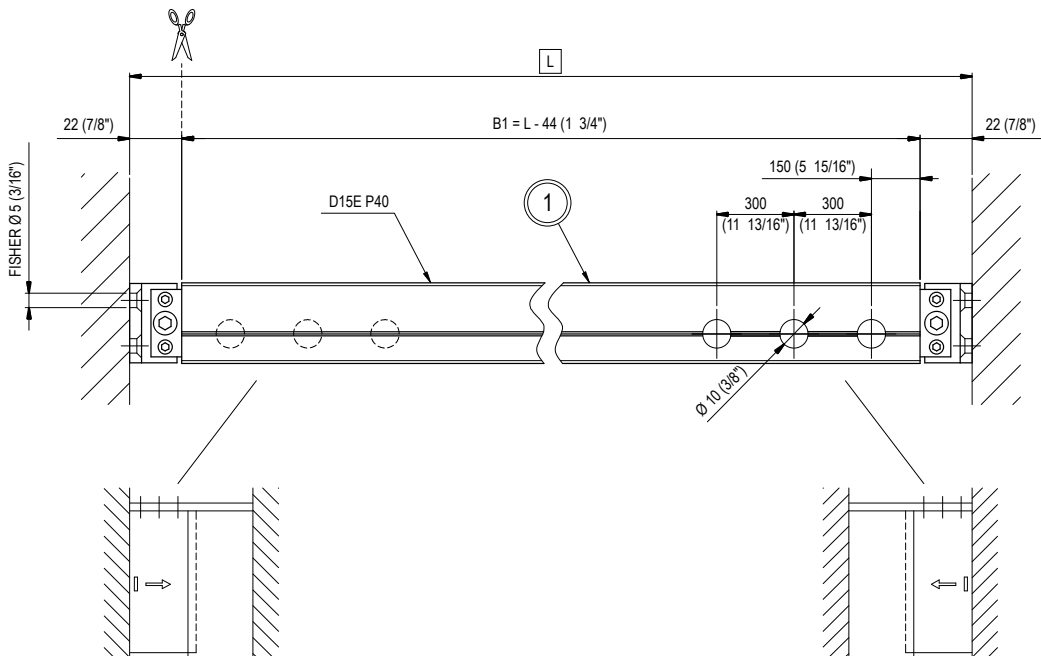
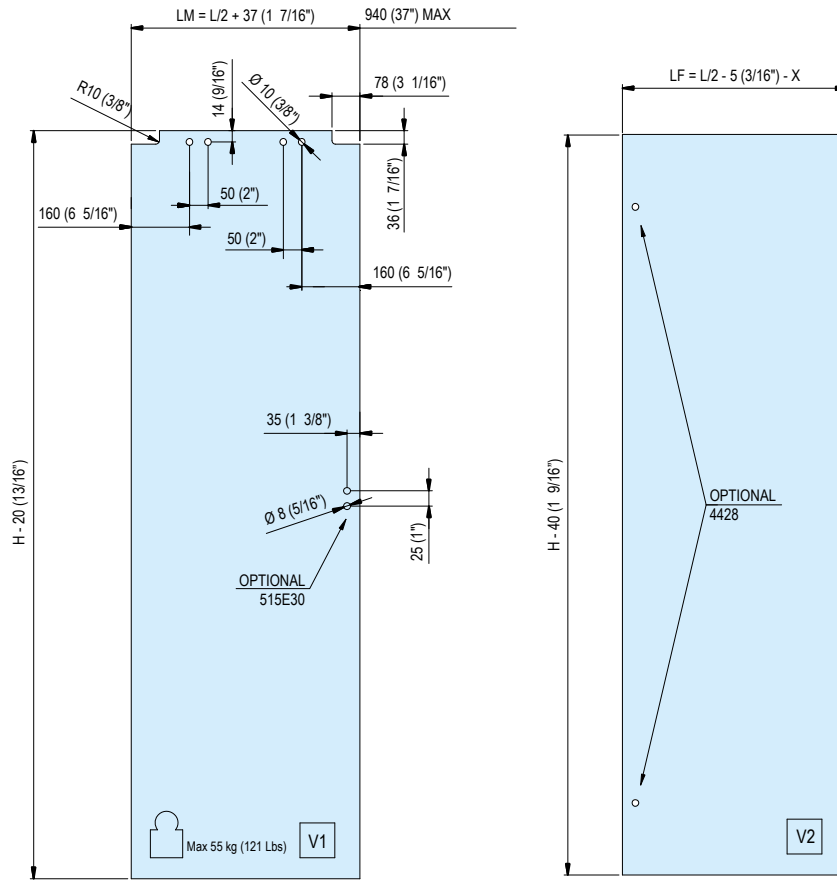

D15E60



PIUMA system

- Kit Piuma per box doccia con 2 spalle in vetro da 1000 a 1800mm.
- Kit Piuma para mampara de baño fijación a vidrios laterales de 1000 a 1800mm.
- Piuma set with 2 fixed side glazings from 1000mm up to 1800mm.
- Beschlagset Piuma für U-Dusche Glas-Glas mit Länge 1000mm bis 1800mm.
- Kit Piuma avec 2. 2 panneaux en verre fixes de 1000 à 1800mm.

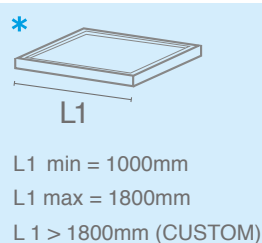

Compresso / Included

D15E P10 (1X)

D15E P10S (1X) + D15E P10D (1X)



D15E P80 (2X)



D15E P90S (1X)

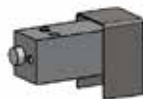

D15E P90D (1X)



D15E P30 (1X)

L1 > 900



D12E J02 (8X)



D12E J53 (4X)



Non compreso / Not included

D15E P40/10 (0,92 mt)

L = 780 ÷ 964mm

D15E P40/13 (1,32 mt)

L = 965 ÷ 1364mm

D15E P40/18 (1,85 mt)

L = 1365 ÷ 1894mm

D15E P40/24 (2,4 mt)

L > 1895 ÷ 2444mm (CUSTOM)



8PT6-37 Sp.6mm

L = 2200mm



8PT8-37 Sp.8mm

L = 2200mm



D15E P50S (1X)



D15E P50D (1X)

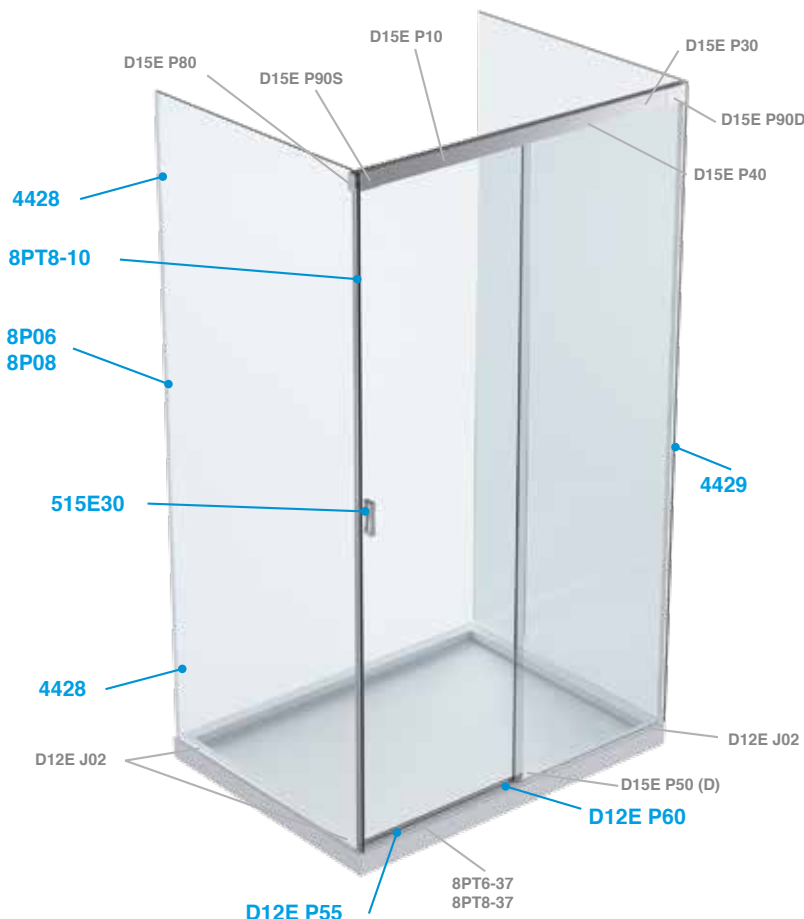
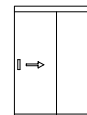

OPTIONAL

Tubolare contenimento acqua e tappi
 Tubo y tapas para contener el agua
 Tubes and caps for water containment
 Wasser abweisendes Rohrprofil und Kappen
 Tubes et connecteurs pour retenue d'eau



D12E P55 (1X)



D12E P60 (1X)

D15E60

PIUMA system

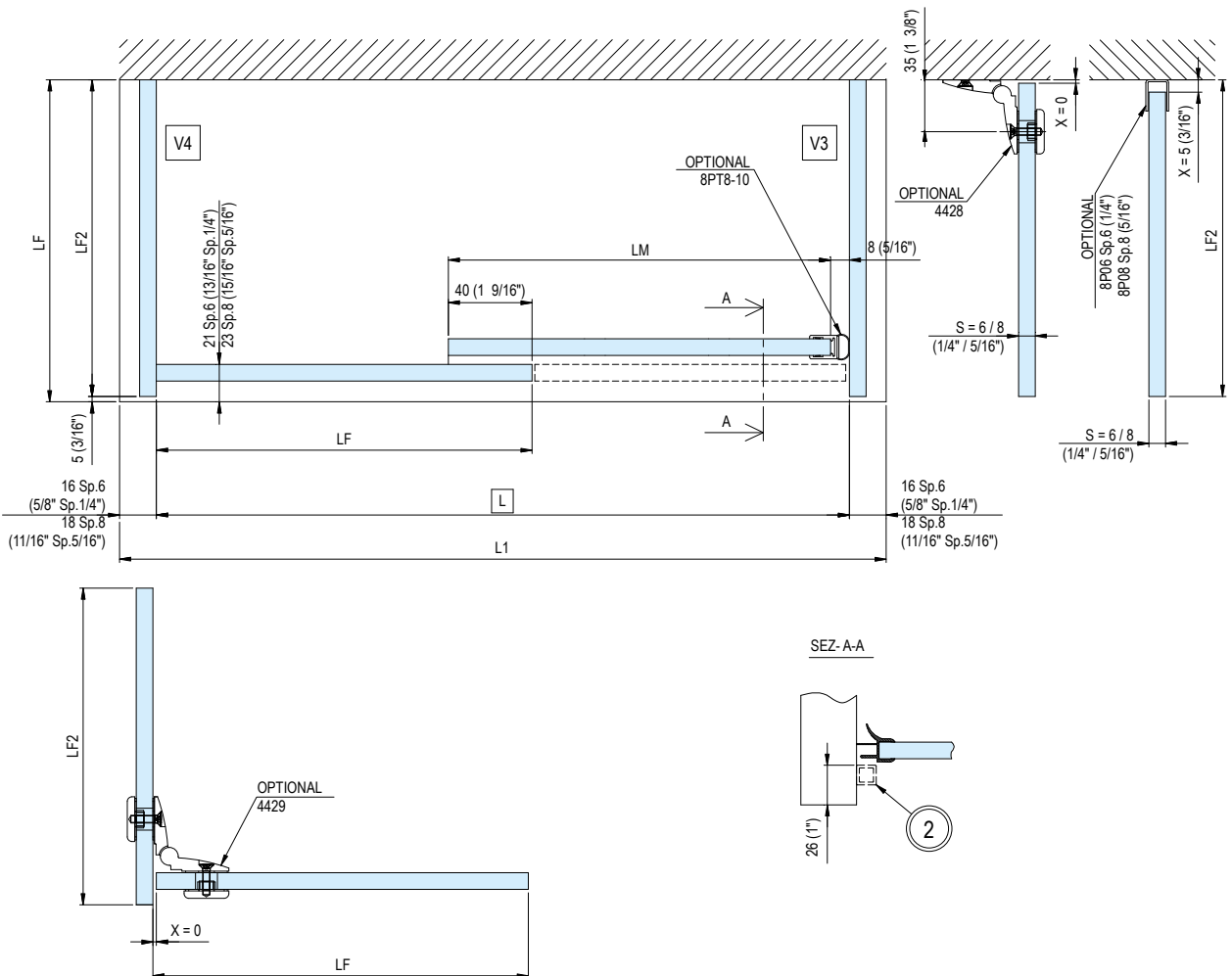
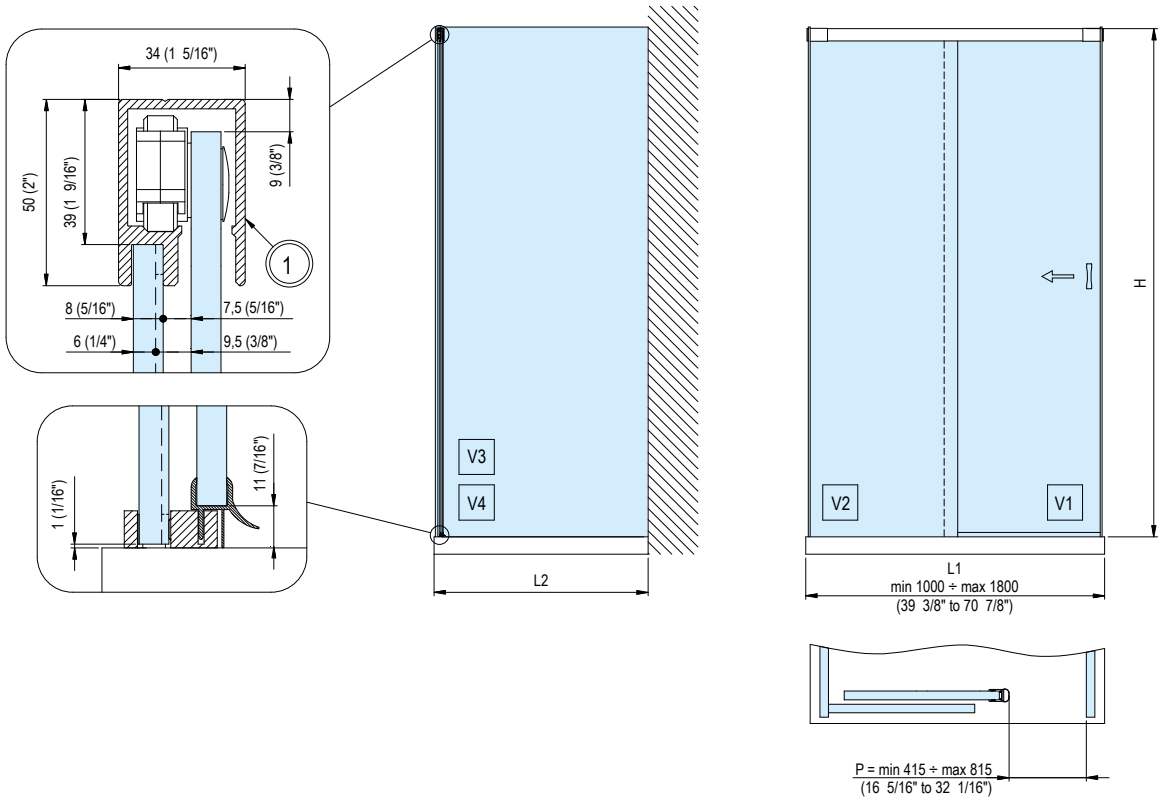

D15E60

PIUMA system

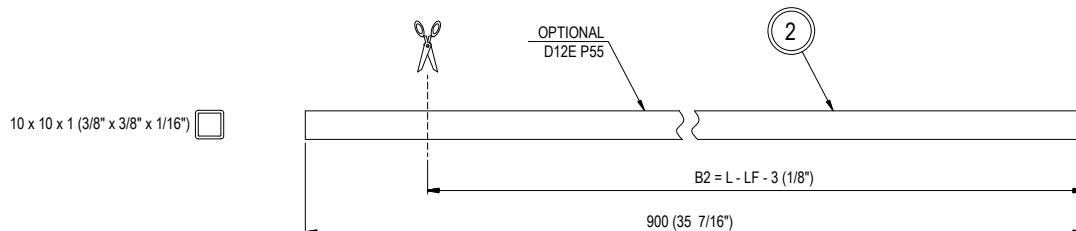
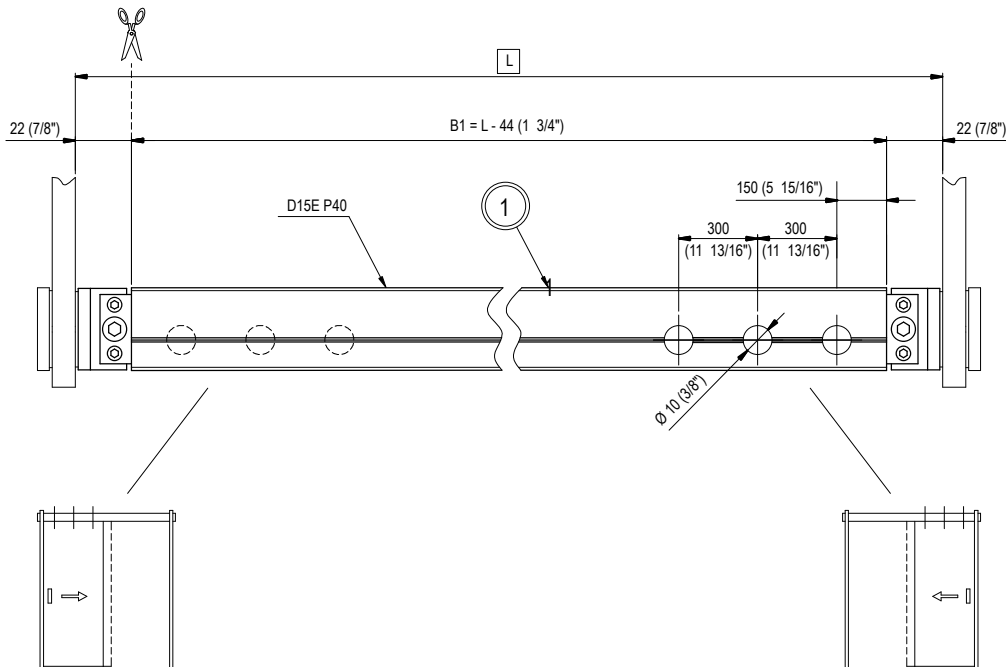
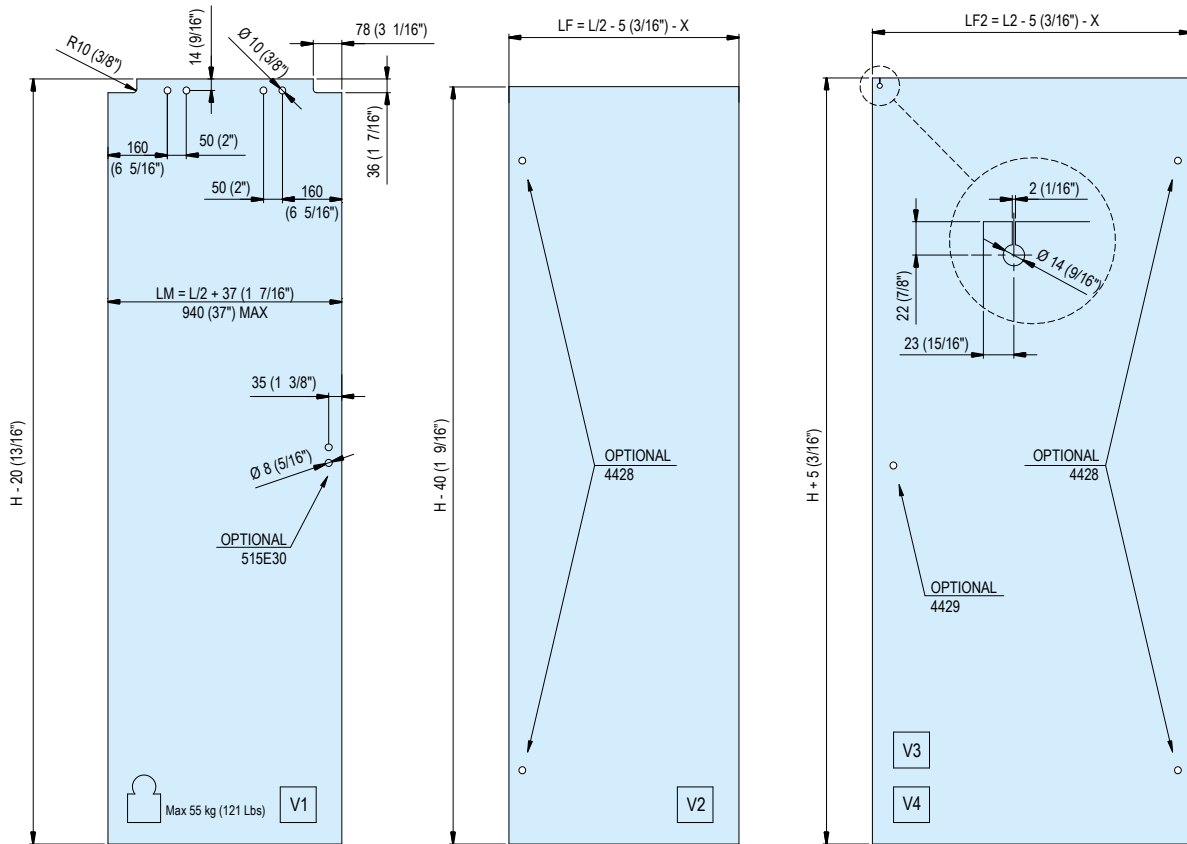

D15E70

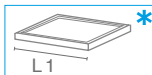
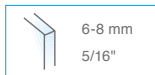

PIUMA system

- Kit Piuma per box doccia ad angolo con 1 spalla in vetro da 1000 a 1800mm.
- Kit Piuma para mampara de baño fijación a pared y a vidrio lateral de 1000 a 1800mm.
- Piuma corner set with 1 fixed side glazing from 1000mm up to 1800mm.
- Beschlagset Piuma für Eckdusche Glas-Glas mit einem Seitenteil 90°. Länge 1000mm bis 1800mm.
- Kit Piuma pour cabine de douche d'angle avec 1 panneau en verre fixe de 1000 à 1800mm.

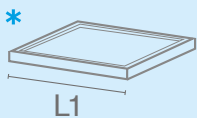

L1 min = 1000mm
L1 max = 1800mm
L1 > 1800mm (CUSTOM)

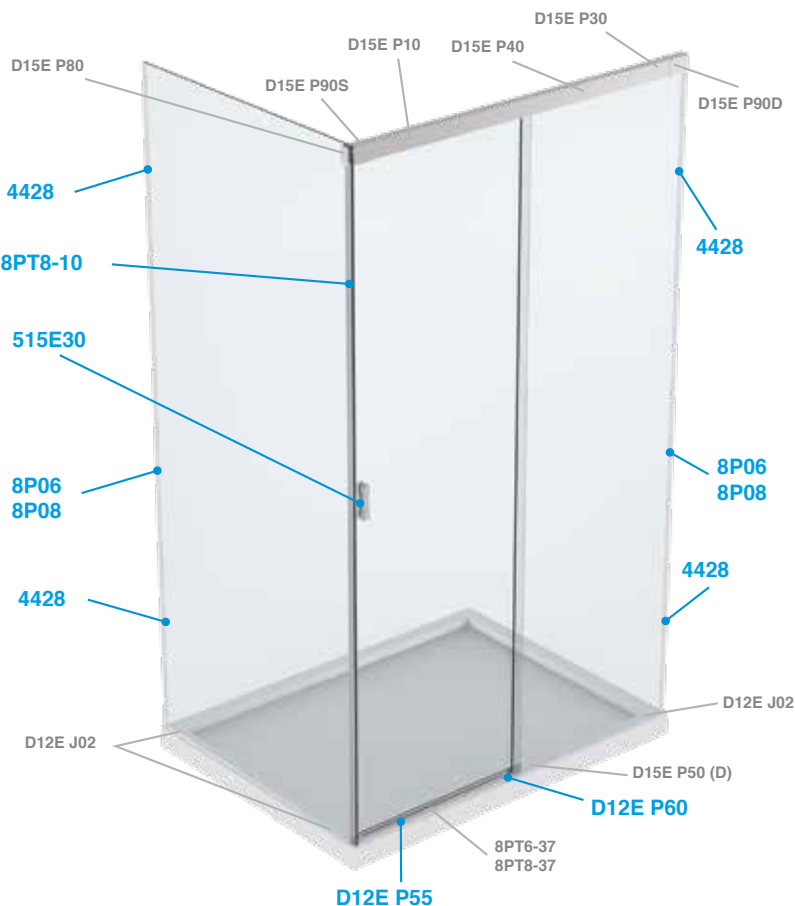

Compreso / Included

D15E P10 (1X)

D15E P10S (1X) + D15E P10D (1X)



D15E P80 (1X)



D15E P90S (1X)



D15E P90D (1X)



D15E P30 (1X)

L1 > 900



D12E J02 (8X)



D12E J53 (4X)



Non compreso / Not included

D15E P40/10 (0,92 mt)

L = 780 ÷ 964mm

D15E P40/13 (1,32 mt)

L = 965 ÷ 1364mm

D15E P40/18 (1,85 mt)

L = 1365 ÷ 1894mm

D15E P40/24 (2,4 mt)

L > 1895 ÷ 2444mm (CUSTOM)



8PT6-37 Sp.6mm

L = 2200mm



8PT8-37 Sp.8mm

L = 2200mm



D15E P50S (1X)



D15E P50D (1X)

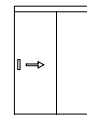

OPTIONAL

Tubolare contenimento acqua e tappi
Tubo y tapas para contener el agua
Tubes and caps for water containment
Wasser abweisendes Rohrprofil und Kappen
Tubes et connecteurs pour retenue d'eau



D12E P55
(1X)



D12E P60
(1X)

D15E70

PIUMA system

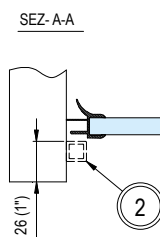
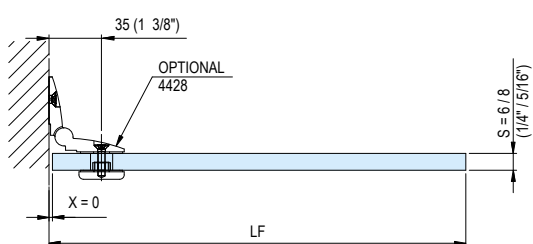
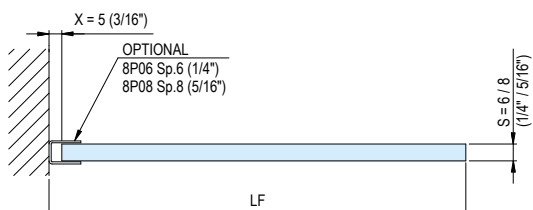
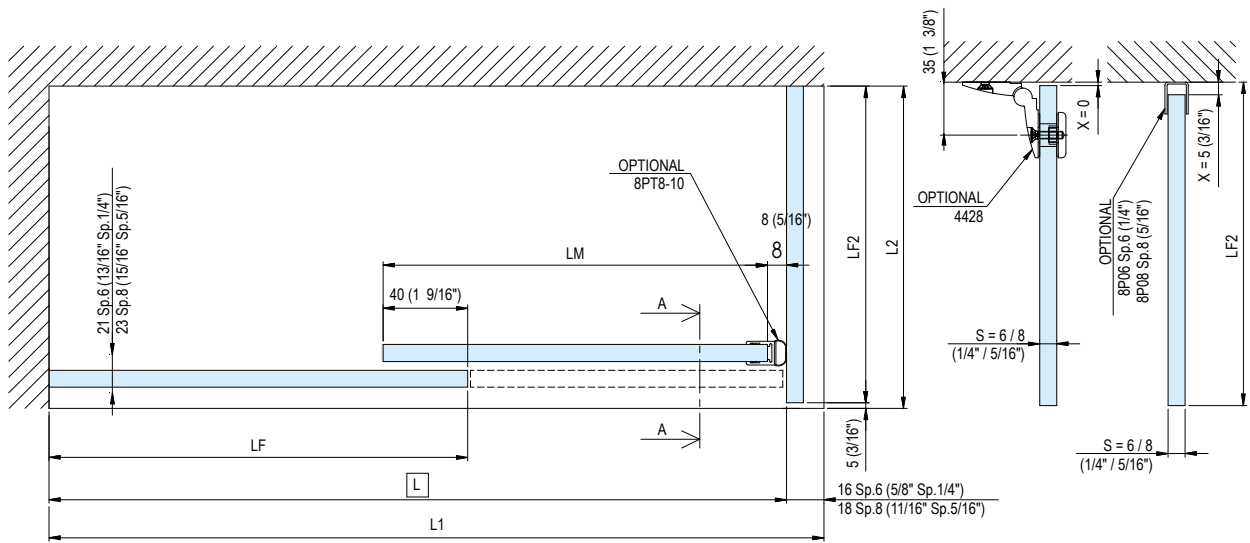
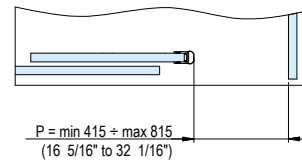
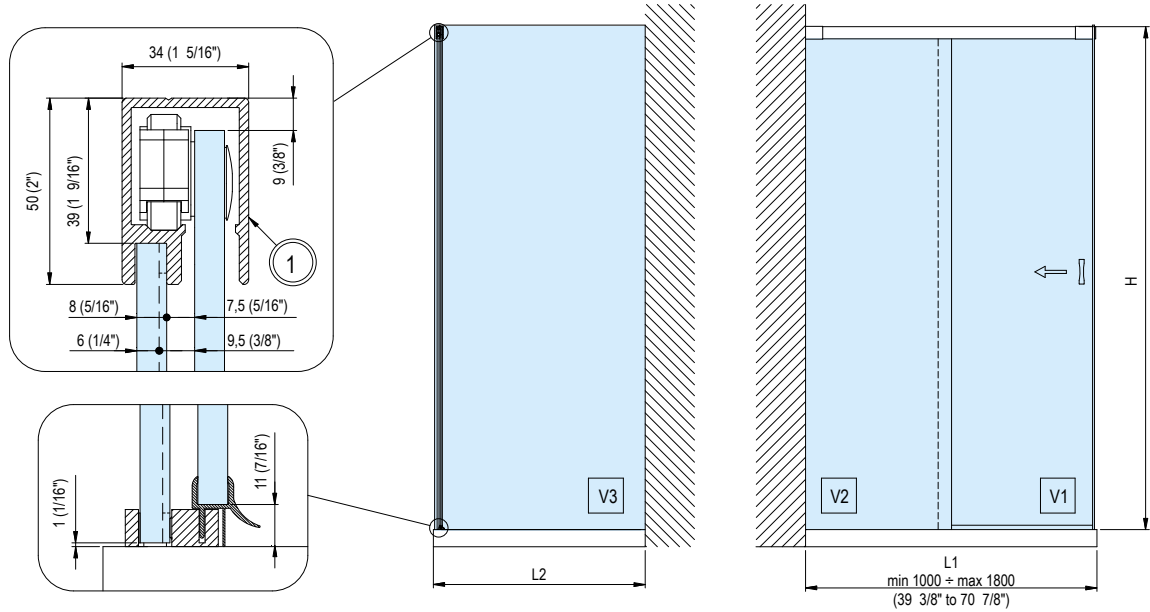

D15E70

PIUMA system

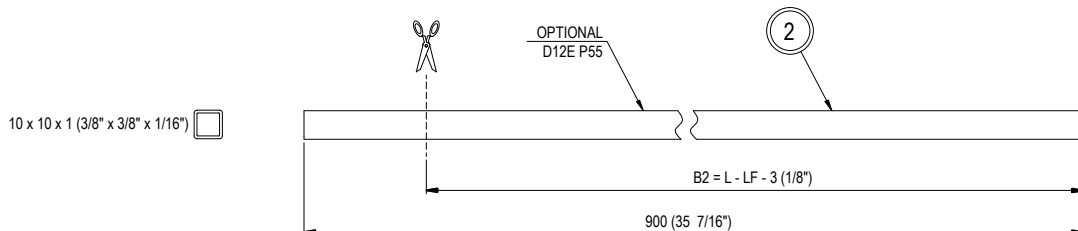
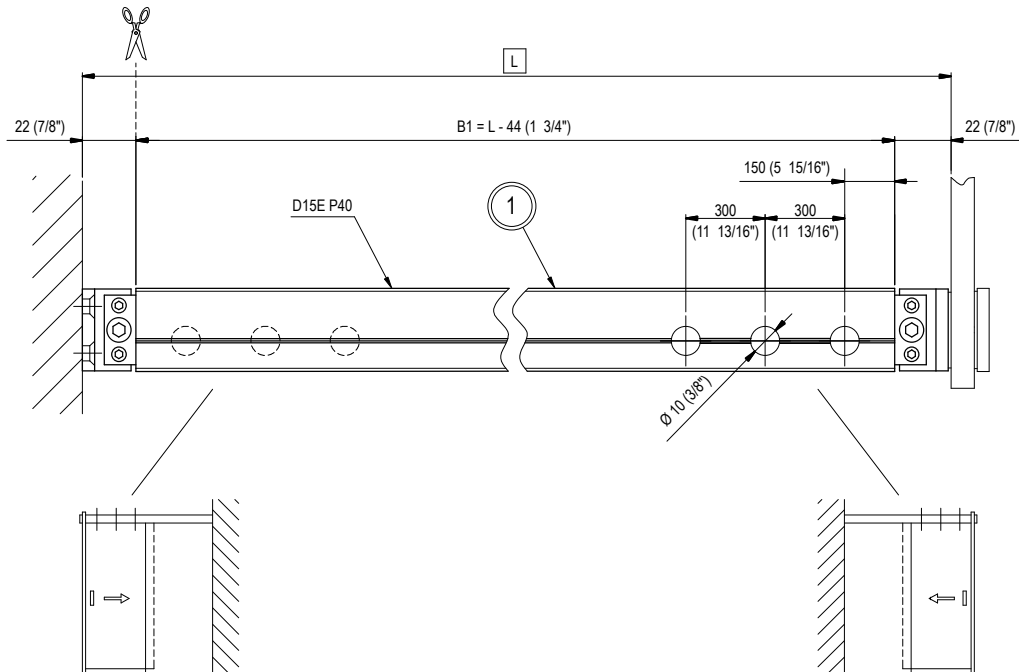
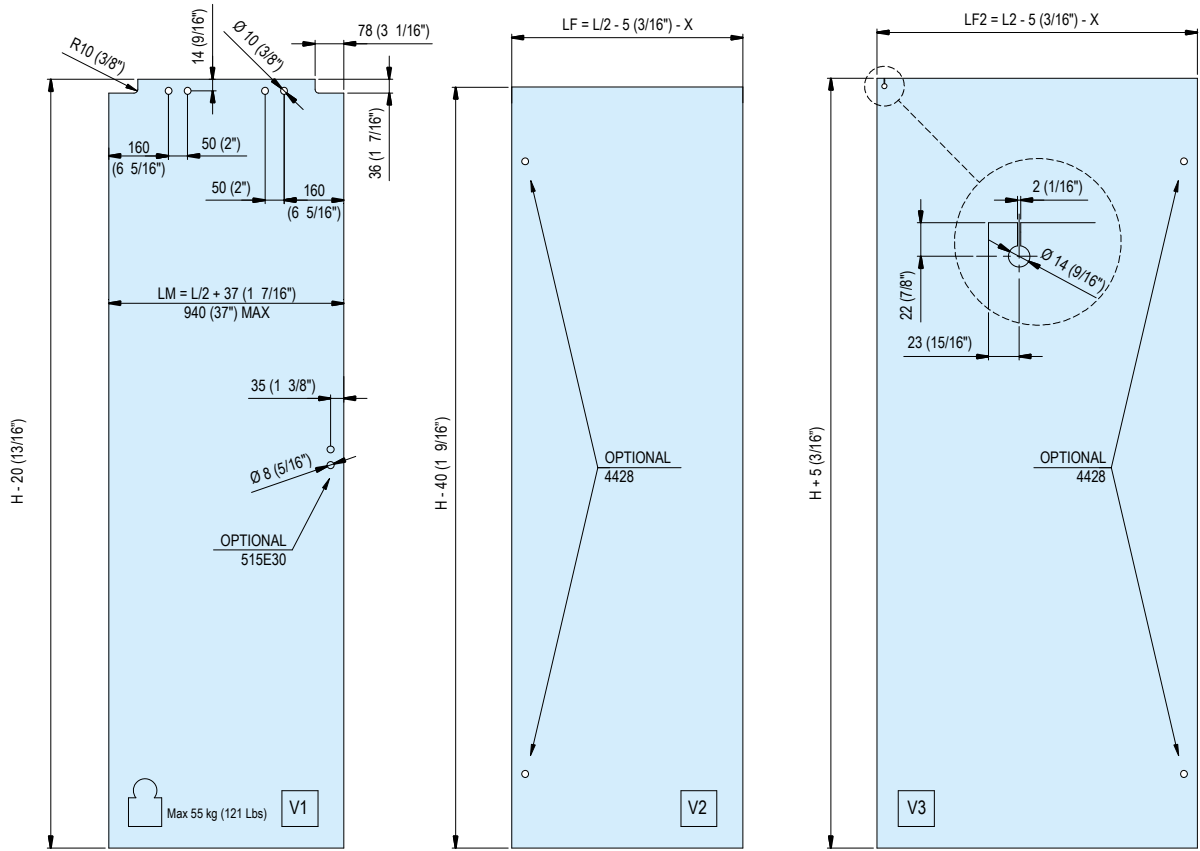

sistemi / systems

kit **HIP-ZAC**



BZ00
BZQ0



BZ03
BZQ3



BZ06
BZQ6



BZ07
BZQ7



BZ09
BZQ9

Ottone / Brass - finiture / colors 13-14

Sistema scorrevole per box doccia e sopravasca. Nasce dall'elegante e alleggerita evoluzione degli scorrevoli "a vista" per porte interne. Il tubo è in acciaio inox, il sistema è disponibile a sezione tonda o quadra, in 5 versioni applicative e in diverse misure.

Sistema corredero para box ducha y bañera. Nace de la elegante y aliviada evolución de las correderas "a vista" para puertas internas. La barra es en acero inoxidable y el sistema cuenta en cinco versiones con diferentes tamaños.

Sliding system for shower boxes and bath tubs. It is the result of the elegant and lightened evolution of sliding systems "at sight" for inner doors. The pipe is made of stainless steel and the system is available

with round or square section in 5 different versions and size.

Schiebesystem für Duschen und Wannenaufsätze. Das Ergebnis der eleganten und erleichterten Evolution der „sichtbaren“ Schiebesysteme für Innentüren. Das Rohr besteht aus Edelstahl und ist in den runden und vier-eckigen Ausführungen in 5 Varianten und verschiedenen Maßen verfügbar.

Le Hipzac est un système coulissant pour cabine de douche et baignoire. Il est né de l'évolution élégante et allégée des portes coulissantes «visibles» pour portes intérieures. Le tube est en acier inoxydable, disponible des sections ronde ou carrée, et qui se décline en 5 références de différentes tailles pour des applications variées.





BZ00

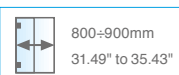

• Kit Hip-zac ad angolo. Sezione tonda. Per piatto 800÷900mm.

• Kit Hip-zac angular. Sección redonda. Plato de ducha 800÷900mm.

• Hip Zac corner kit. Round section. Shower tray size 800÷900mm.

• Schiebetürsystem Hip Zac für Ecke. Rundschnitt. Duschwanne 800÷900mm.

• Kit d'angle Hip-zac. Section ronde. Pour bac de douche 800÷900mm.

HIP-ZAC system

BZ00K composto da / composed of



4 x BZ10



2 x BZ51



1 x BZ57



1 x BZ20



2 x BZ30



4 x BZ70



2 x BZ45

+

BZ0K40 composto da / composed of

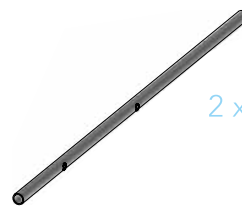

2 x BZ40



2 x BZ55



BZ00

HIP-ZAC system

DATI (Data)

DATI (Data)

DATI (Data)

CALCOLARE (Calculate)

L = min 800 ÷ max 900 (mm)

P = 400 (mm)

LM = 390 (mm)

LF = (SCHEMA)

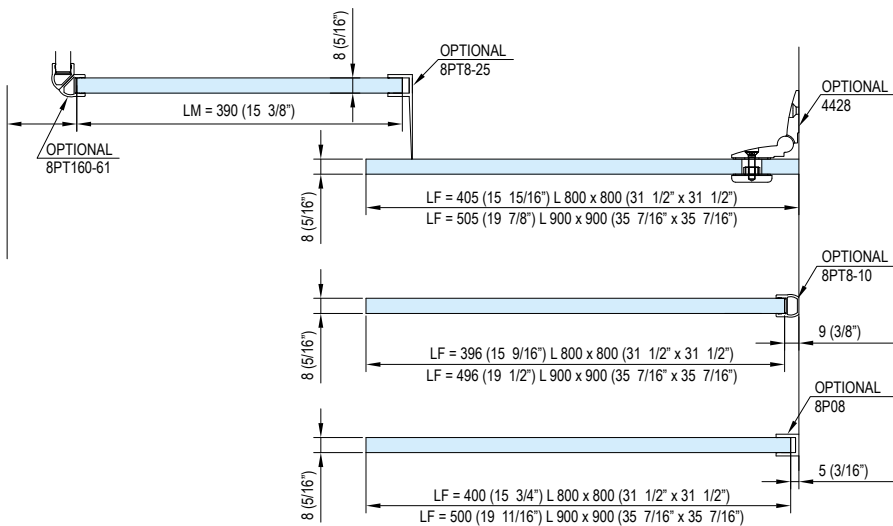
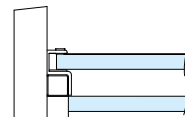
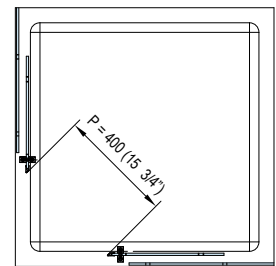
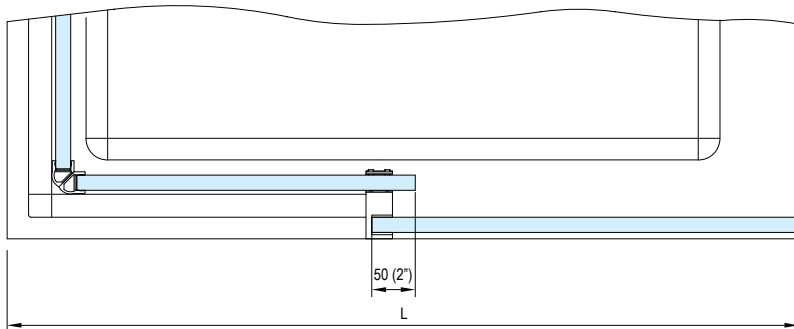
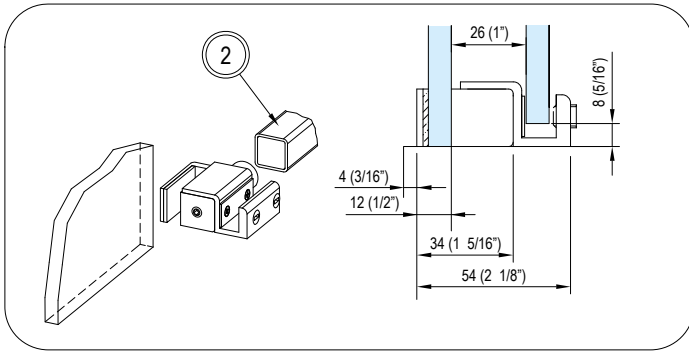
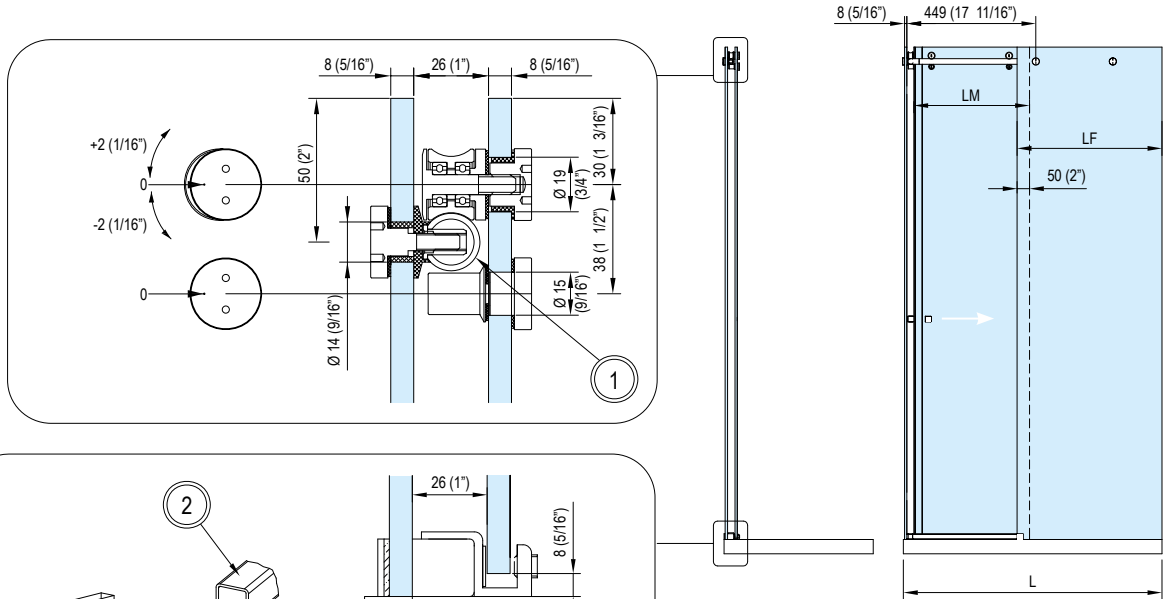

BZ00

HIP-ZAC system

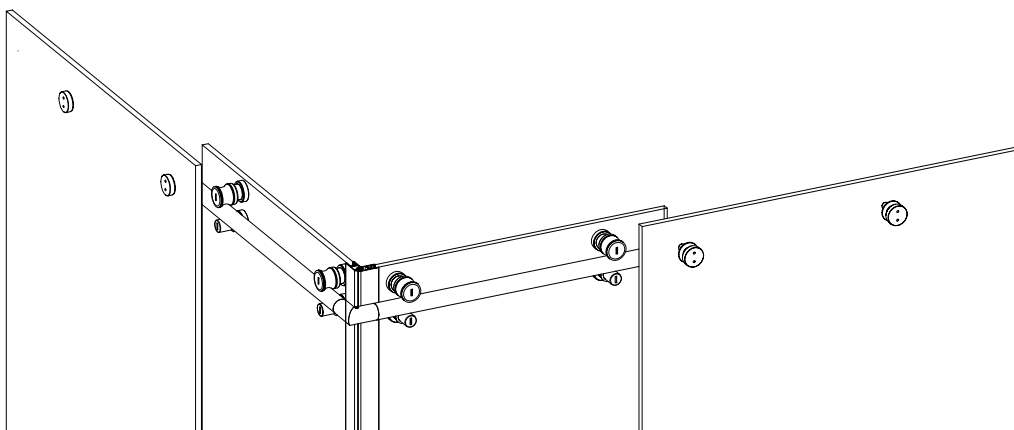
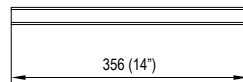
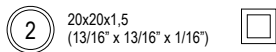
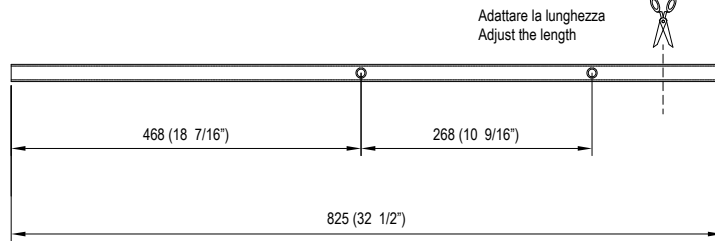
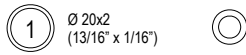
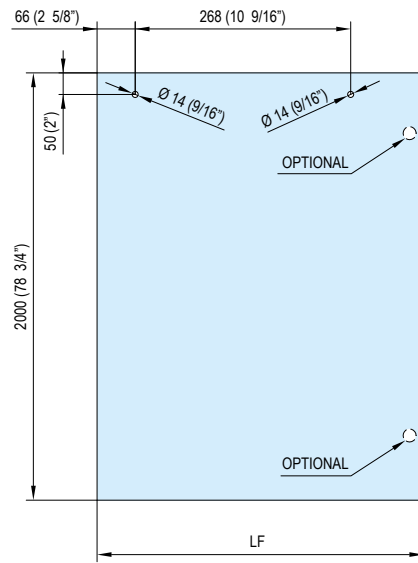
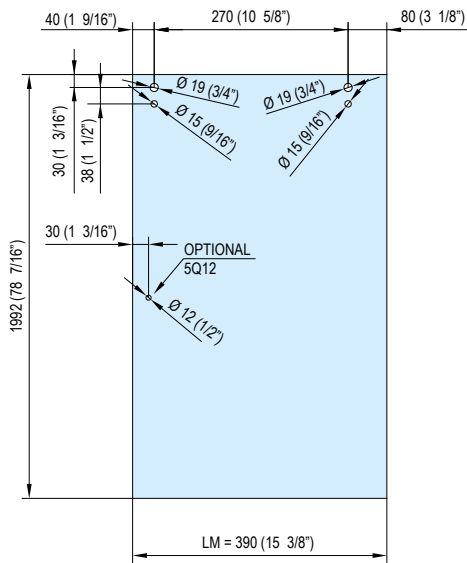

BZQ0

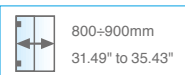
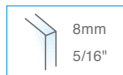

• Kit Hip-zac ad angolo. Sezione quadrata. Per piatto 800÷900mm.

• Kit Hip-zac angular. Sección cuadrada. Plato ducha 800÷900mm.

• Hip Zac corner kit. Square section. Shower tray size 800÷900mm.

• Schiebetürsystem Hip Zac für Ecke. Vierkantschnitt. Duschwanne 800÷900mm.

• Kit d'angle Hip-zac. Section carrée. Pour bac de douche 800÷900mm.

HIP-ZAC system

BZQ0K

composto da / composed of

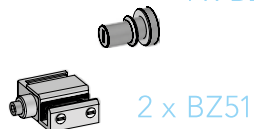

+

BZQK40

composto da / composed of

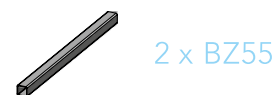
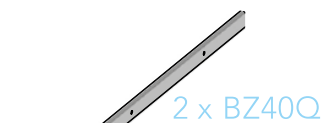

BZQ0

HIP-ZAC system

DATI (Data) L = min 800 ÷ max 900 (mm)
 DATI (Data) P = 400 (mm)
 DATI (Data) LM = 390 (mm)
 CALCOLARE (Calculate) LF = (SCHEMA) (mm)

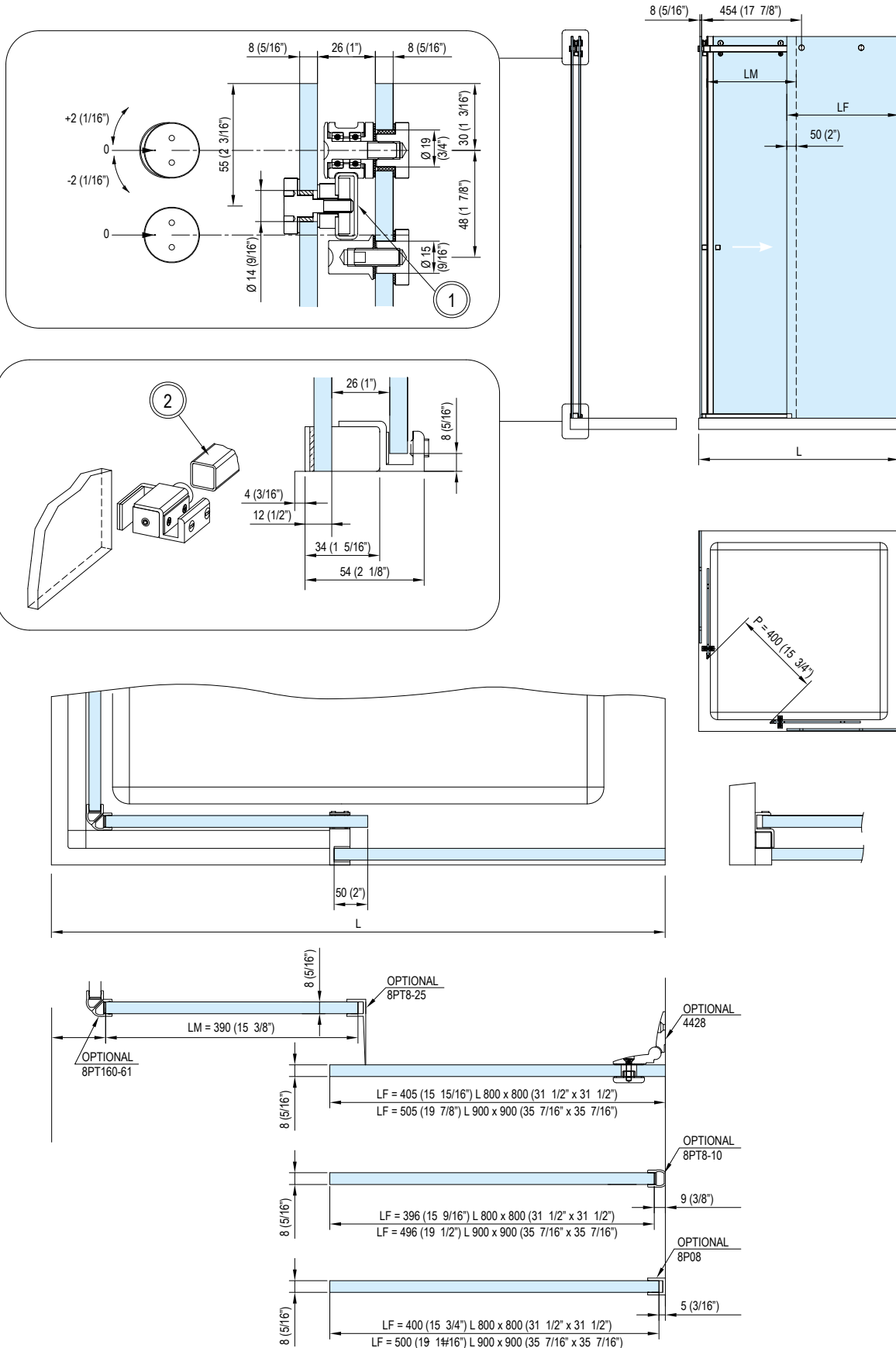

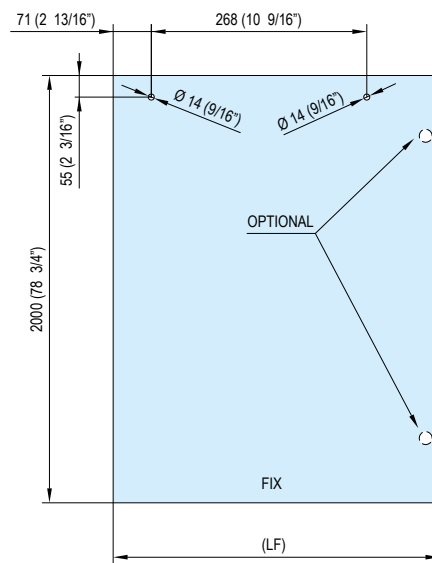
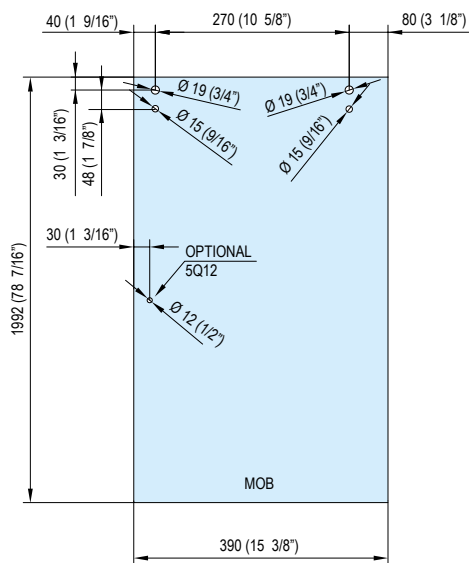

1 30x10x1,5
(1 3/16" x 3/8" x 1/16")

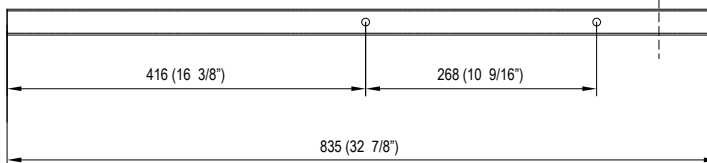

2 20x20x1,5
(13/16" x 13/16" x 1/16")

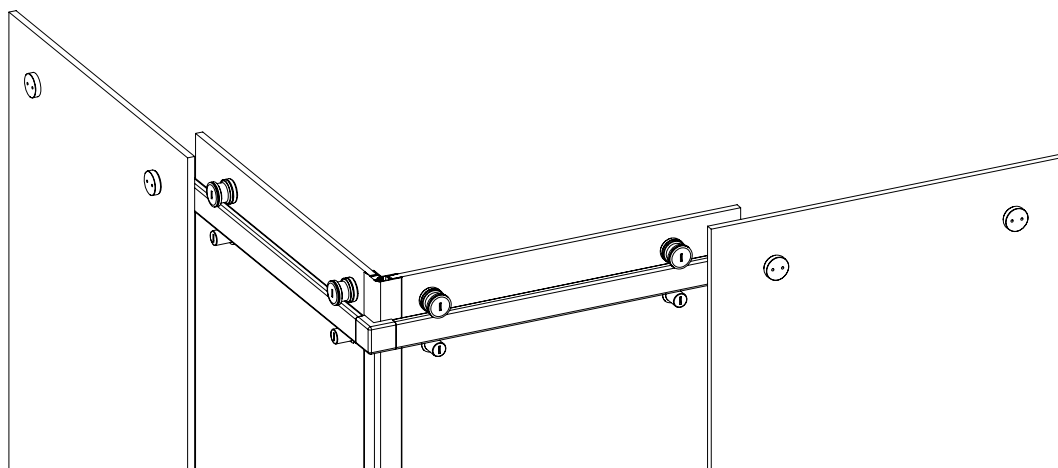
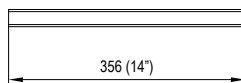

BZ03

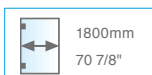
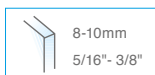

• Kit Hip-zac per box doccia in nicchia da 1200 a 1800mm. Sezione tonda.

• Kit Hip-zac para box ducha de nicho desde 1200 a 1800mm. Sección redonda.

• Hip Zac niche kit 1200-1800mm. Round section.

• Schiebetürsystem Hip Zac für Nische 1200-1800mm. Rundschnitt.

• Kit Hip-zac pour cabine de douche en niche de 1200 à 1800mm. Section ronde.

HIP-ZAC system

BZ03K

composto da / composed of

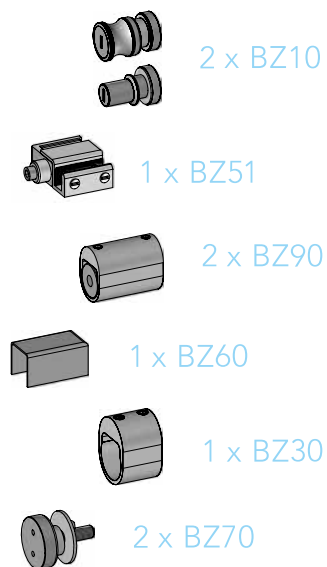

+

BZ0K43

composto da / composed of



BZ03

HIP-ZAC system

DATI (Data)	$L = \text{min } 1200 \div \text{max } 1800$	(mm)
DEFINIRE (Define)	$P = \text{min } 450 \div \text{max } (L/2-55)$	(mm)
CALCOLARE (Calculate)	$LM = (P+55)$	(mm)
CALCOLARE (Calculate)	$LF = (L-P)$	(mm)

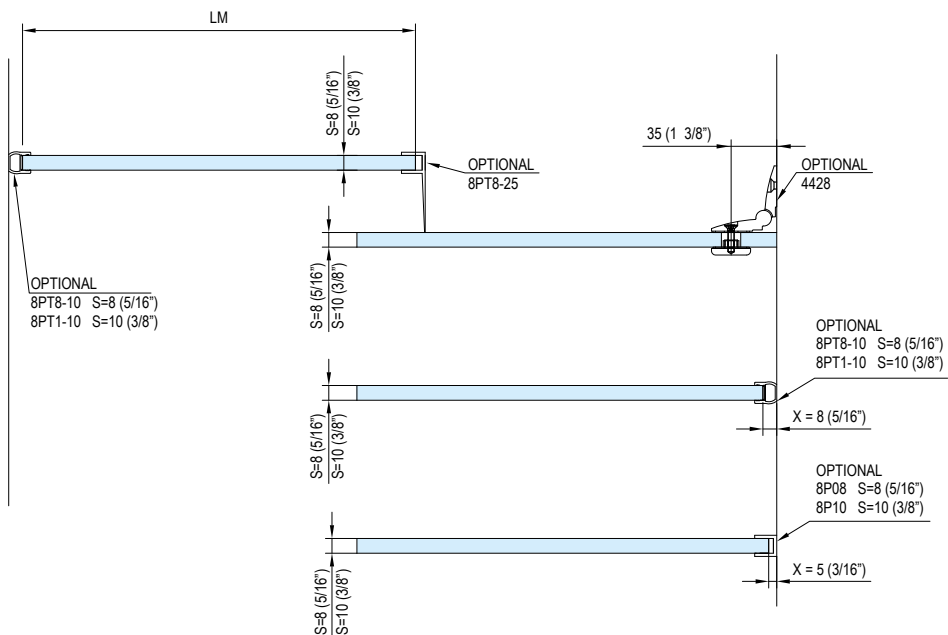
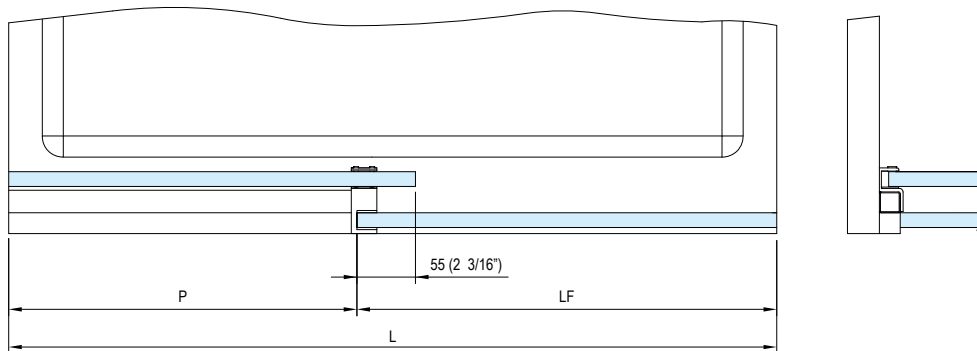
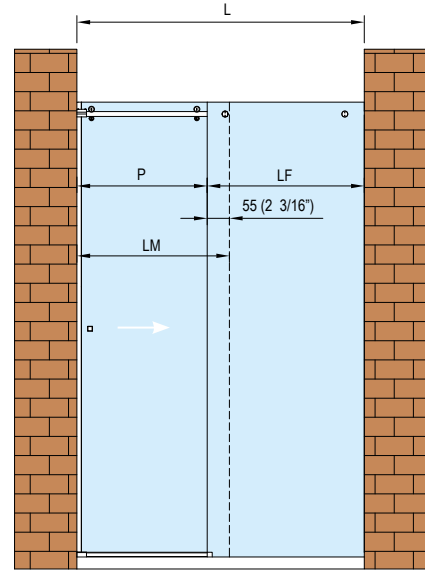
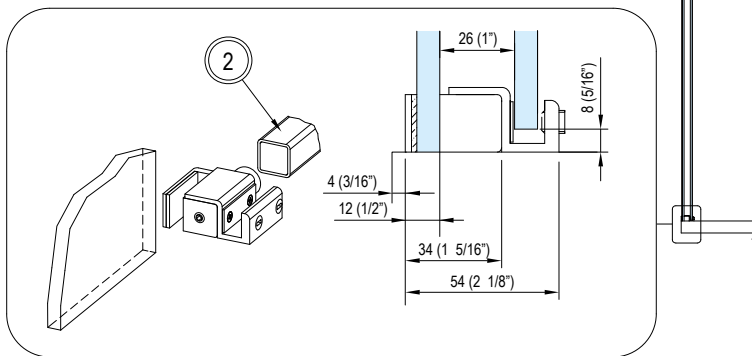
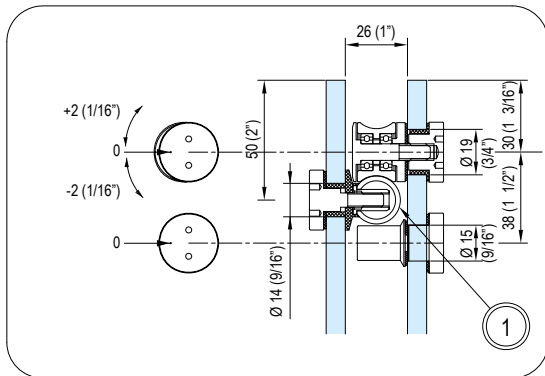

BZ03

HIP-ZAC system

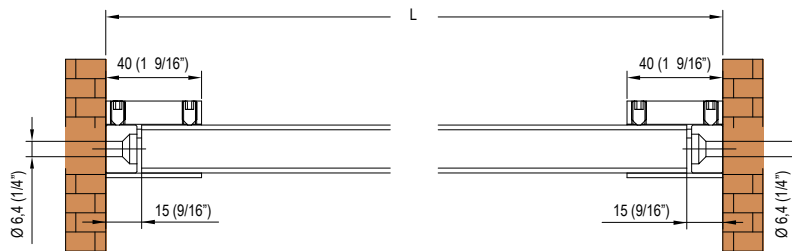
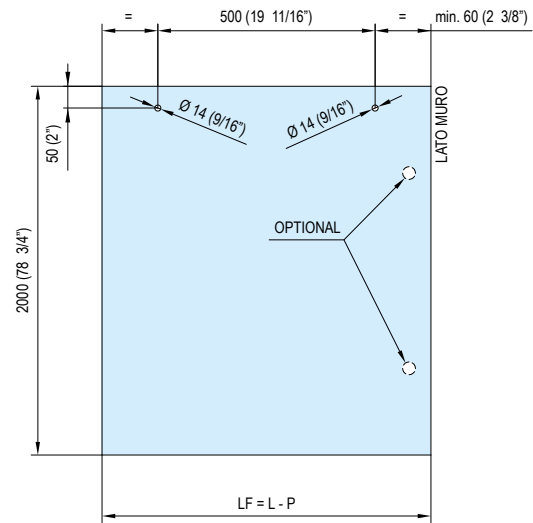
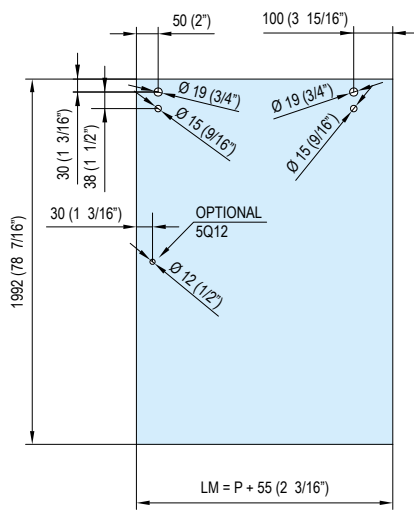

1 $\varnothing 20 \times 1.5$
(13/16" x 1/16")

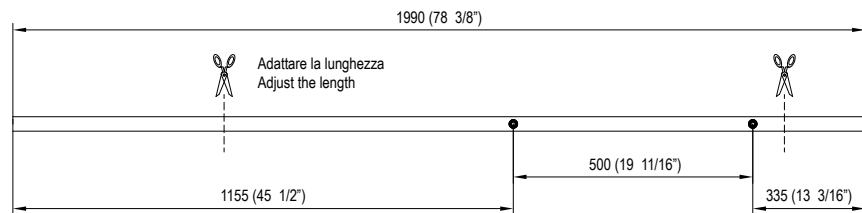

2 20x20x1.5
(13/16" x 13/16" x 1/16")

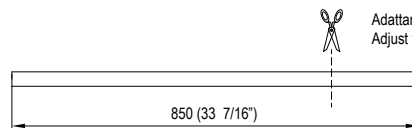

BZQ3

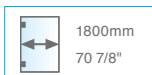
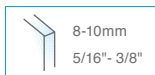

• Kit Hip-zac per box doccia in nicchia da 1200 a 1800mm.
Sezione quadrata.

• Kit Hip-zac para box ducha de nicho desde 1200 a 1800mm.
Sección cuadrada.

• Hip Zac niche kit 1200-1800mm.
Square section.

• Schiebetürsystem Hip Zac für Nische 1200-1800mm. Vierkantschnitt.

• Kit Hip-zac pour cabine de douche en niche de 1200 à 1800mm.
Section carrée.

HIP-ZAC system

BZQ3K composto da / composed of

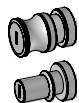

2 x BZ10Q



1 x BZ51



2 x BZ90Q



1 x BZ60



1 x BZ30Q



2 x BZ70Q

+

BZQK43 composto da / composed of

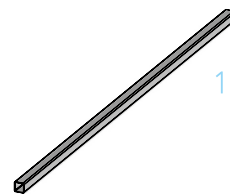

1 x BZ58

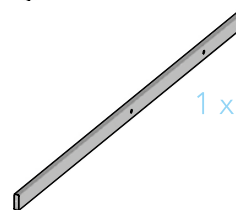

1 x BZ43Q

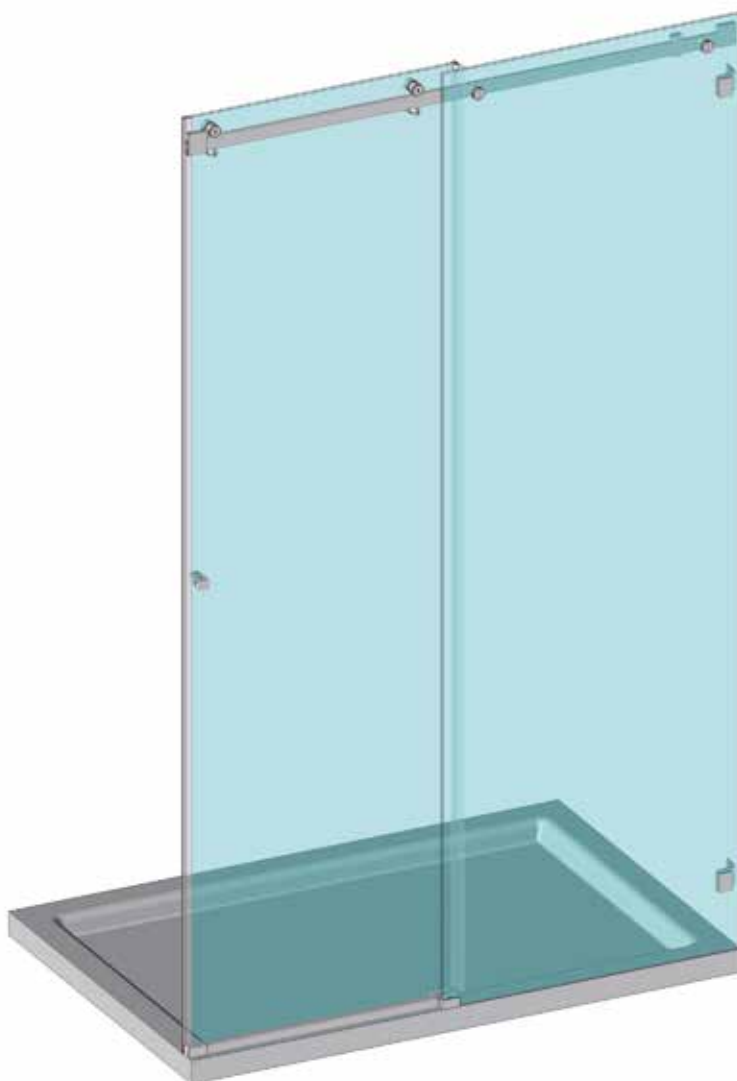

BZQ3

HIP-ZAC system

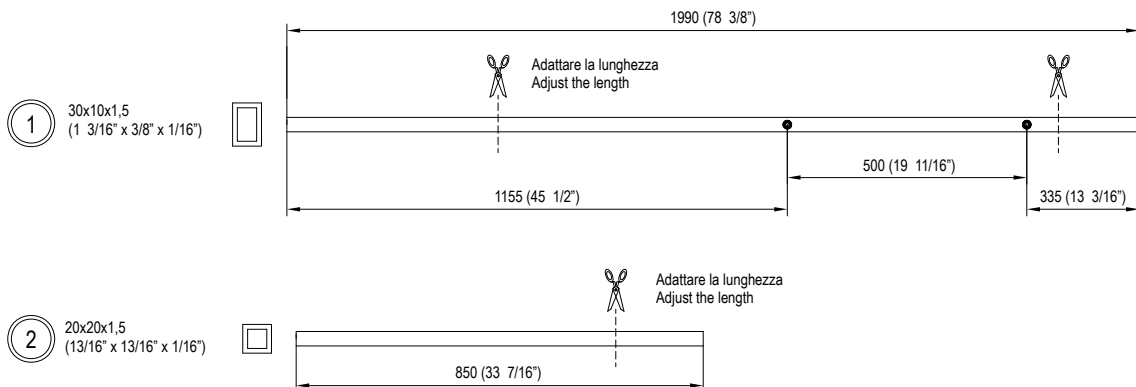
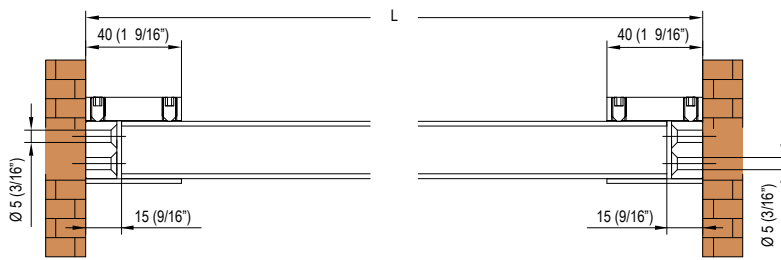
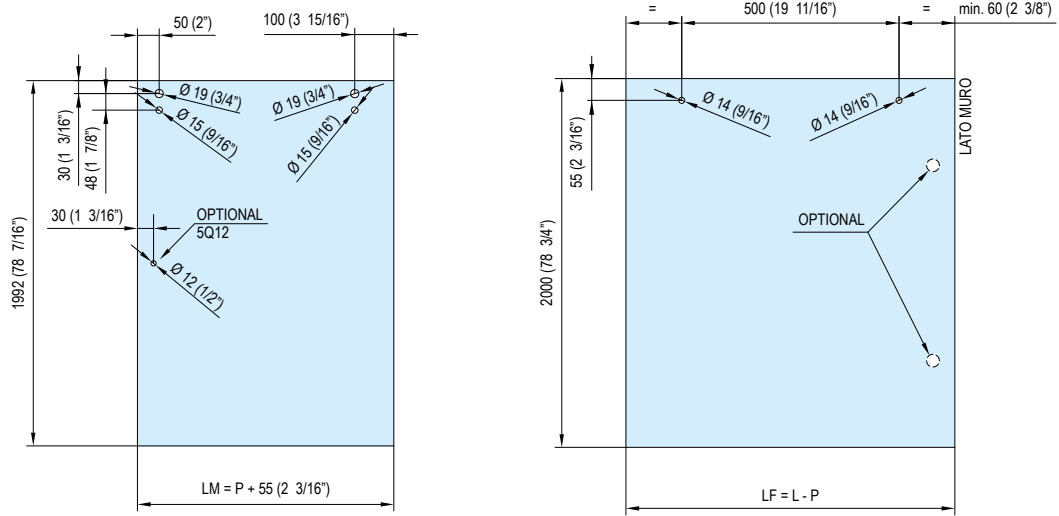

BZ06

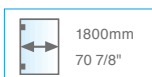
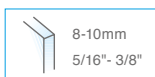

• Kit Hip-zac per box doccia con 2 spalle in vetro da 1200 a 1800mm.

• Kit Hip-zac para box ducha: dos lados en vidrio desde 1200 a 1800mm. Sección redonda.

• Hip Zac kit with 2 fixed glass panels 1200-1800mm. Round section.

• Schiebetürsystem Hip Zac mit 2 starren Glasplatten 1200-1800mm. Rundschnitt.

• Kit Hip-zac pour cabine de douche avec 2 retours en verre de 1200 à 1800mm. Section ronde.

HIP-ZAC system

BZ06K

composto da / composed of



2 x BZ10



1 x BZ51



1 x BZ60



1 x BZ30



2 x BZ70



2 x BZ80

+

BZ0K43

composto da / composed of



1 x BZ58



1 x BZ43



BZ06

HIP-ZAC system

DATI (Data)	$L = \min 1200 \div \max 1800$	(mm)
DEFINIRE (Define)	$P = \min 450 \div \max (L/2-55)$	(mm)
CALCOLARE (Calculate)	$LM = (P+55)$	(mm)
CALCOLARE (Calculate)	$LF = (L-P)$	(mm)
DEFINIRE (Define)	LL	(mm)

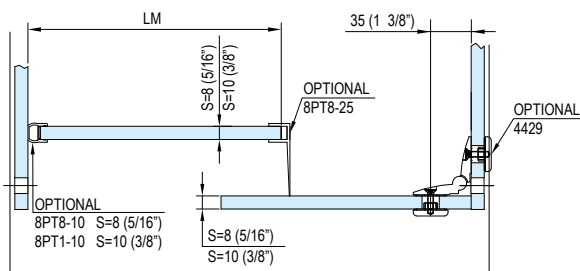
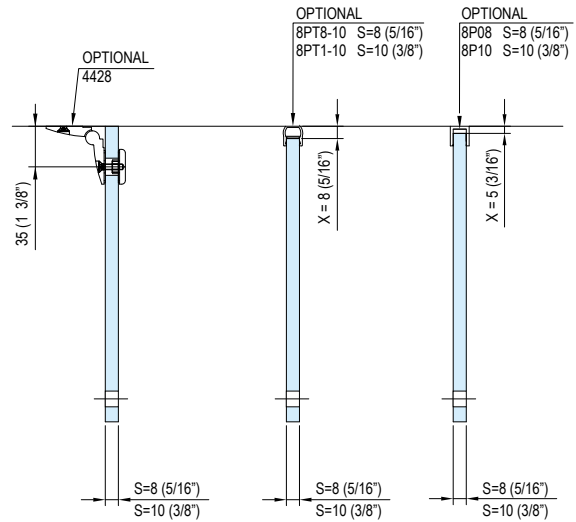
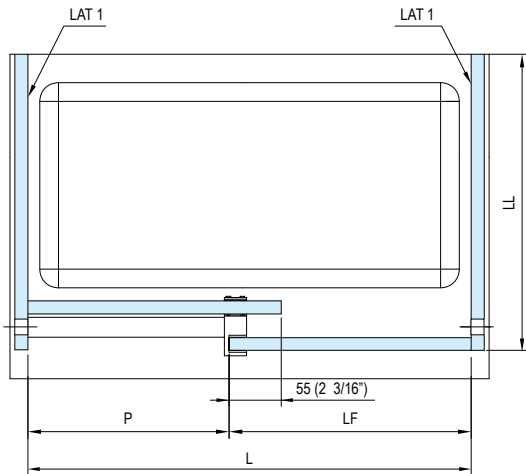
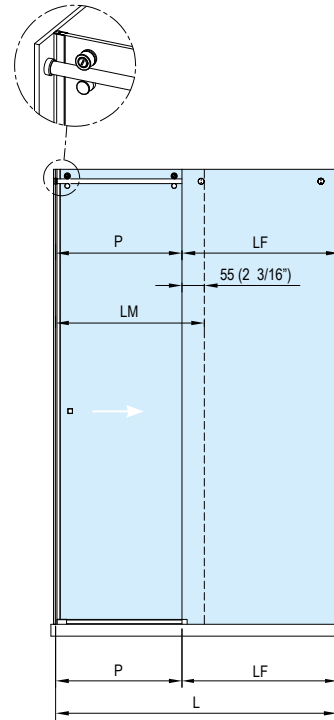
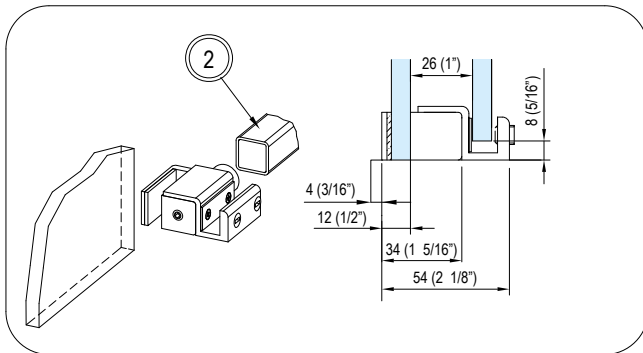
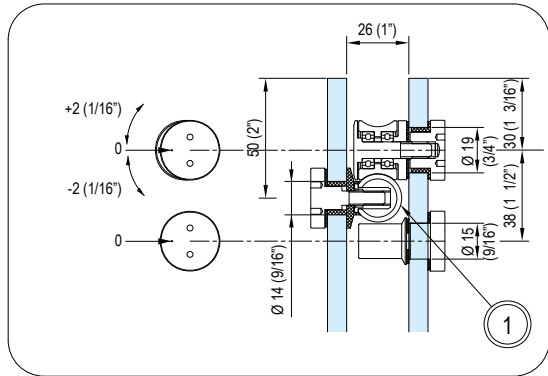

BZ06

HIP-ZAC system

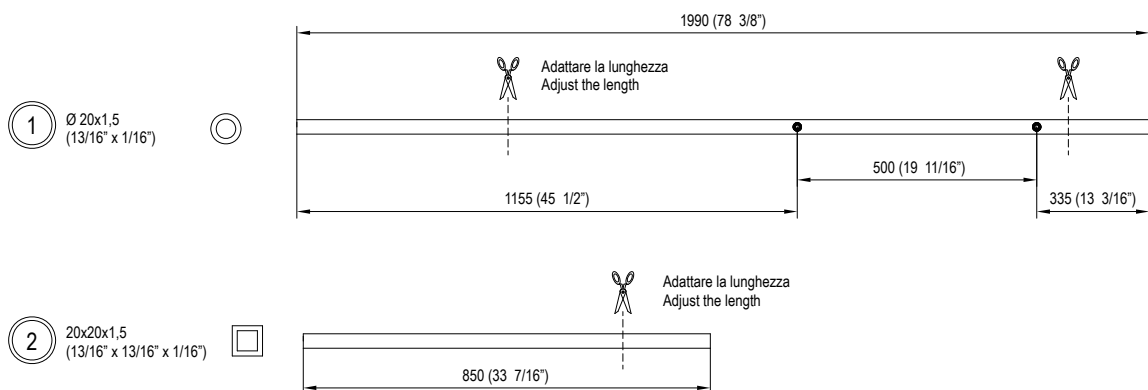
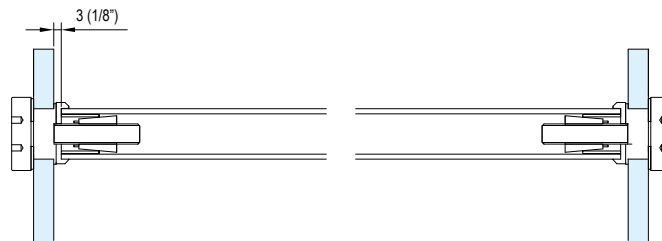
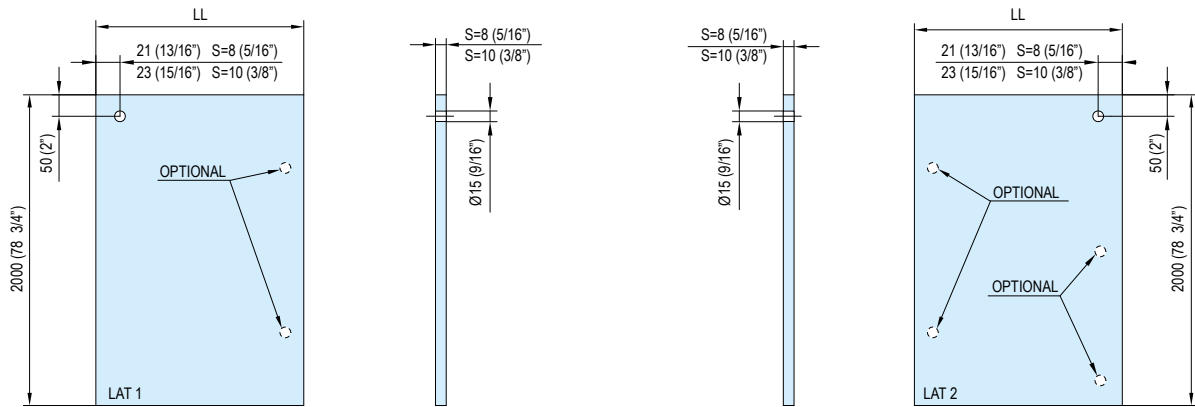
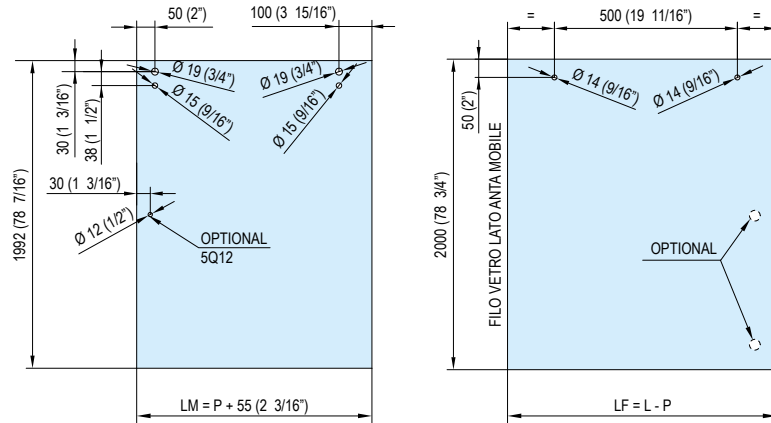

BZQ6

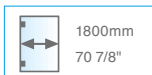
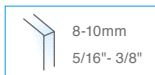

• Kit Hip-zac per box doccia con 2 spalle in vetro da 1200 a 1800mm. Sezione quadrata.

• Kit Hip-zac para box ducha: dos lados en vidrio desde 1200 a 1800mm. Sección cuadrada.

• Hip Zac kit with 2 fixed glass panels 1200-1800mm. Square section.

• Schiebetürsystem Hip Zac mit 2 starren Glasplatten 1200-1800mm. Vierkantschnitt.

• Kit Hip-zac pour cabine de douche avec 2 retours en verre 1200 à 1800mm. Section carrée.

HIP-ZAC system

BZQ6K

composto da / composed of



2 x BZ10Q

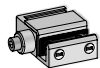

1 x BZ51



1 x BZ30Q



1 x BZ60



2 x BZ80Q



2 x BZ70Q

+

BZQK43

composto da / composed of



1 x BZ58

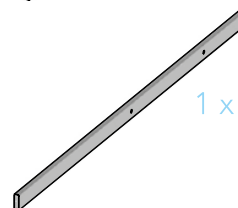

1 x BZ43Q



BZQ6

HIP-ZAC system

DATI (Data)	L = min 1200 ÷ max 1800	(mm)
DEFINIRE (Define)	P = min 450 ÷ max (L/2-55)	(mm)
CALCOLARE (Calculate)	LM = (P+55)	(mm)
CALCOLARE (Calculate)	LF = (L-P)	(mm)
DEFINIRE (Define)	LL	(mm)

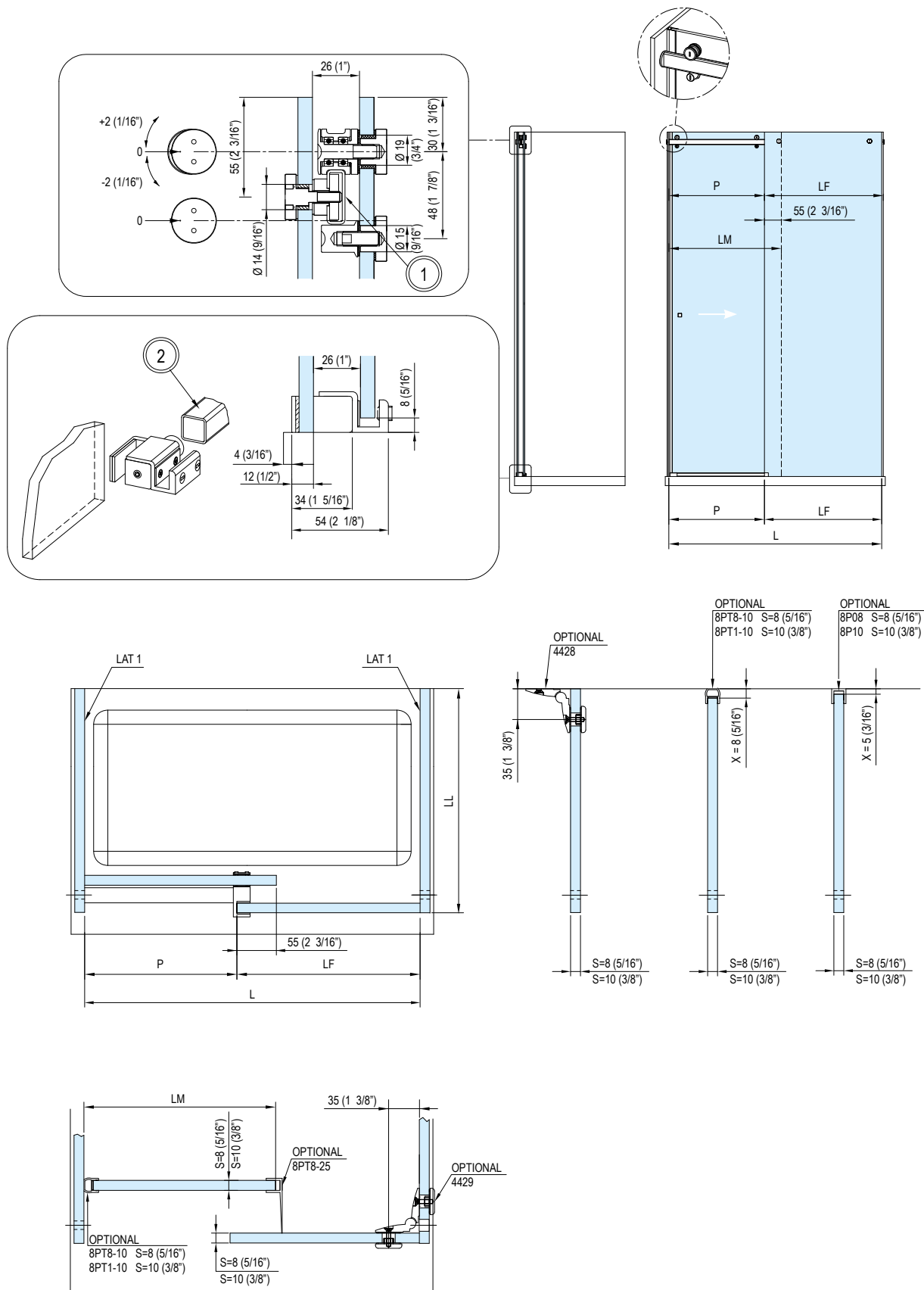

BZQ6

HIP-ZAC system

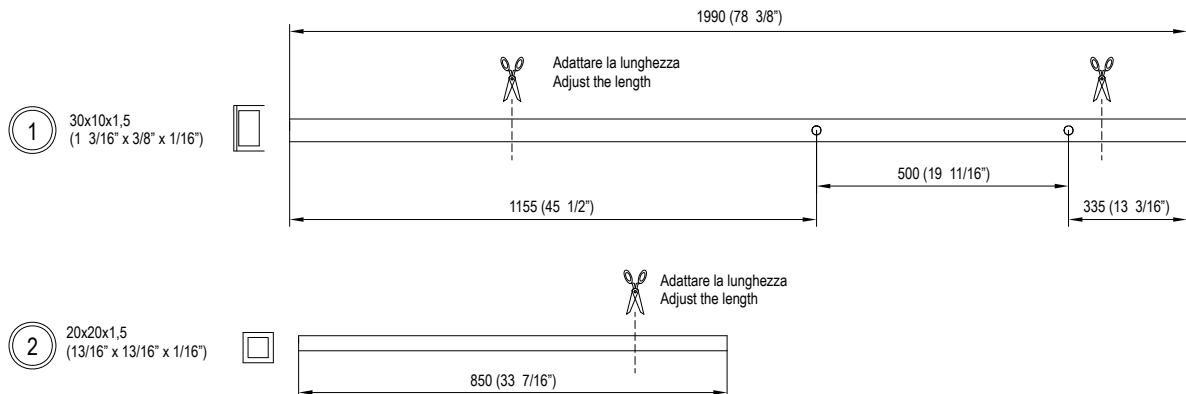
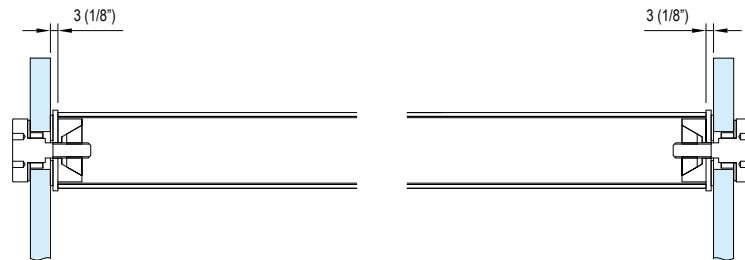
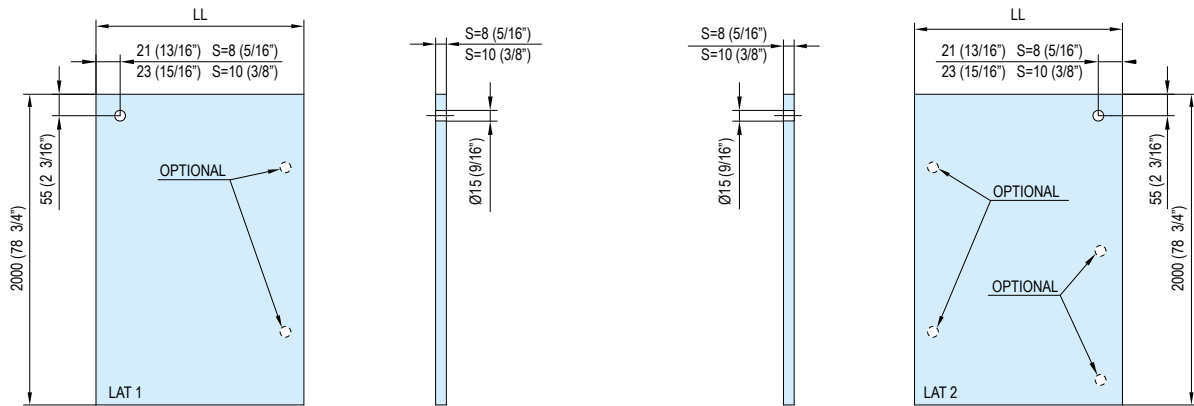
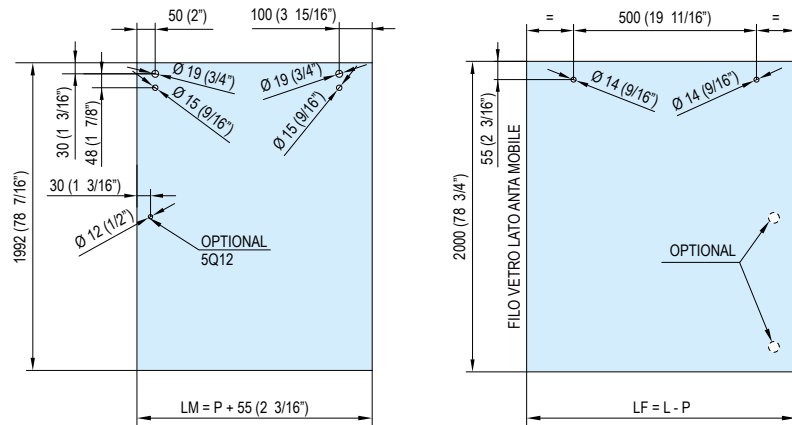

BZ07

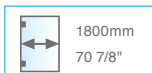
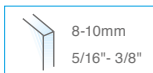

• Kit Hip-zac per box doccia con 1 spalla in vetro da 1200 a 1800mm. Sezione tonda.

• Kit Hip-zac para box ducha: un lado en vidrio desde 1200 a 1800mm. Sección redonda.

• Hip Zac kit with 1 fixed glass panel 1200-1800mm. Round section.

• Schiebetürsystem Hip Zac mit 1 starren Glasplatte 1200-1800mm. Rundschnitt.

• Kit Hip-zac pour cabine de douche avec 1 retour en verre de 1200 à 1800mm. Section ronde

HIP-ZAC system

BZ07K

composto da / composed of



2 x BZ10



1 x BZ51



1 x BZ60



1 x BZ30



1 x BZ90



2 x BZ70



1 x BZ80

+

BZ0K43

composto da / composed of



1 x BZ58



1 x BZ43

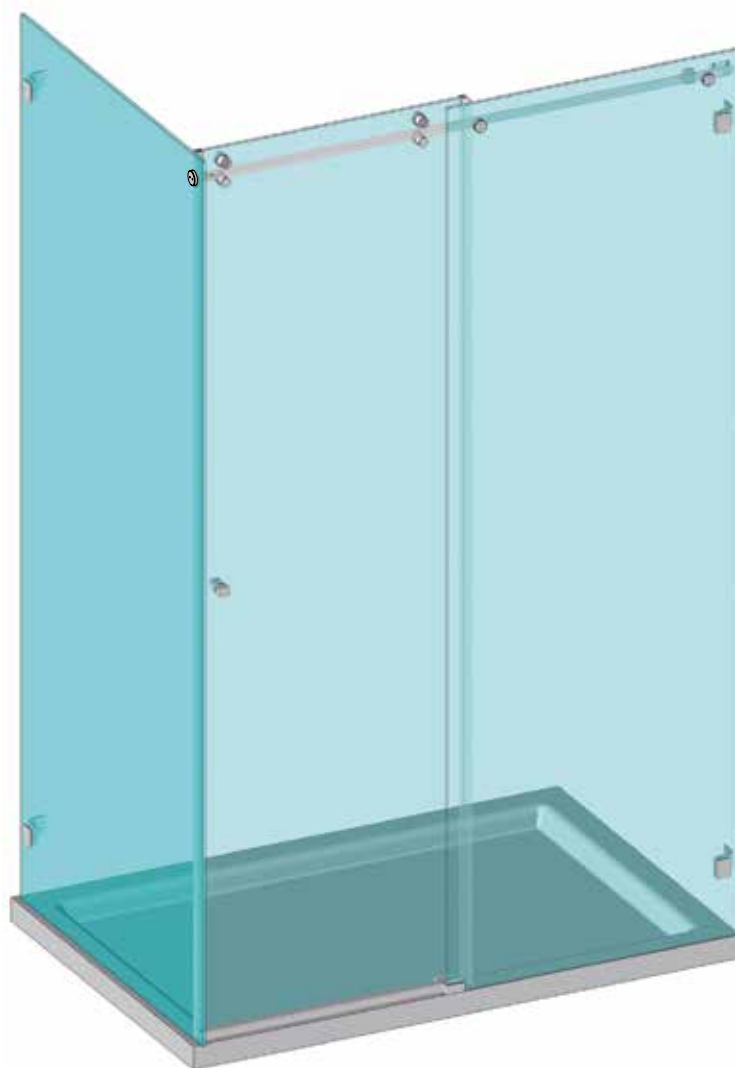

BZ07

HIP-ZAC system

DATI (Data)	L = min 1200 ÷ max 1800	(mm)
DEFINIRE (Define)	P = min 450 ÷ max (L/2-55)	(mm)
CALCOLARE (Calculate)	LM = (P+55)	(mm)
CALCOLARE (Calculate)	LF = (L-P)	(mm)
DEFINIRE (Define)	LL	(mm)

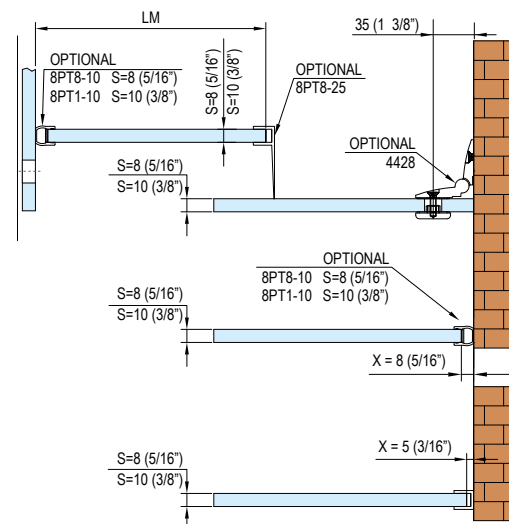
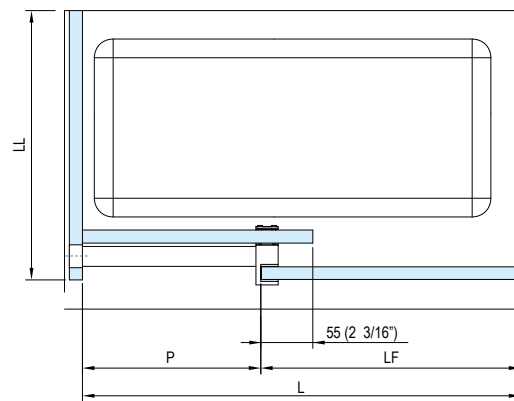
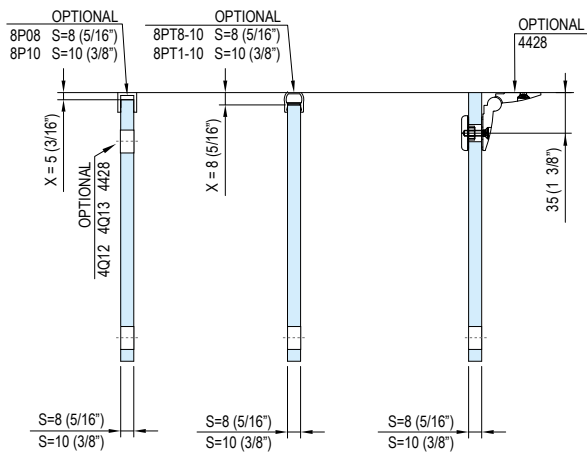
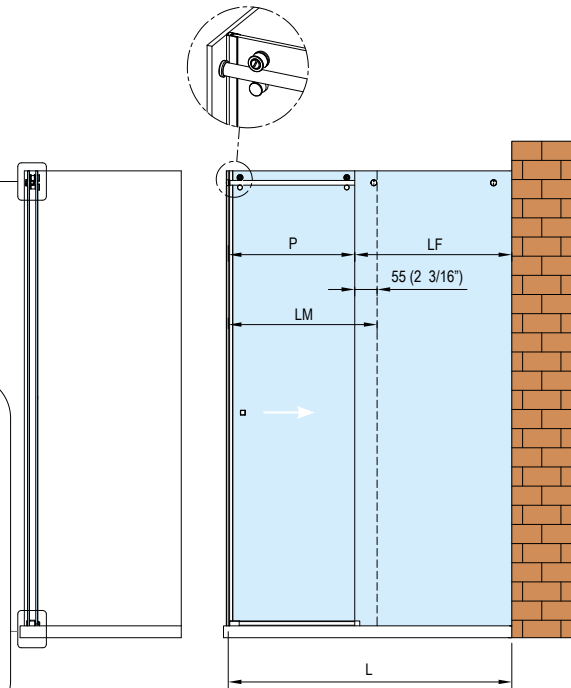
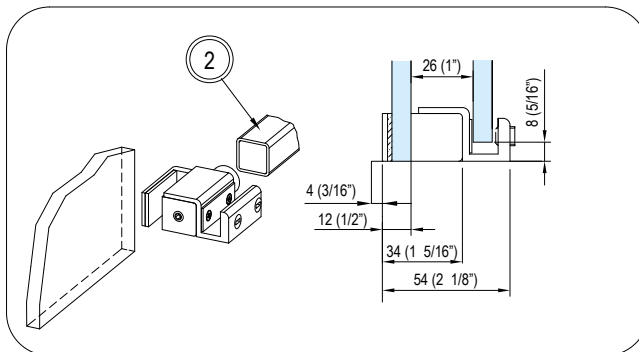
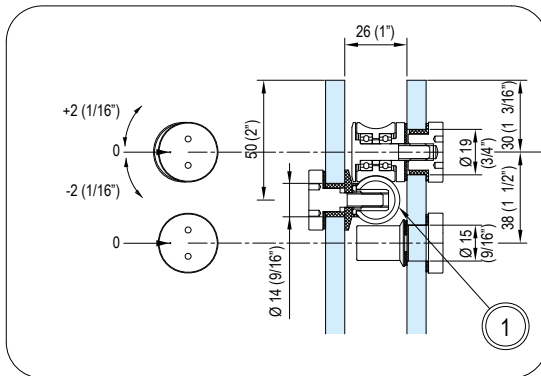

BZ07

HIP-ZAC system

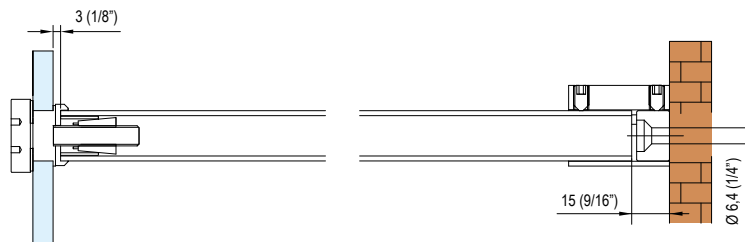
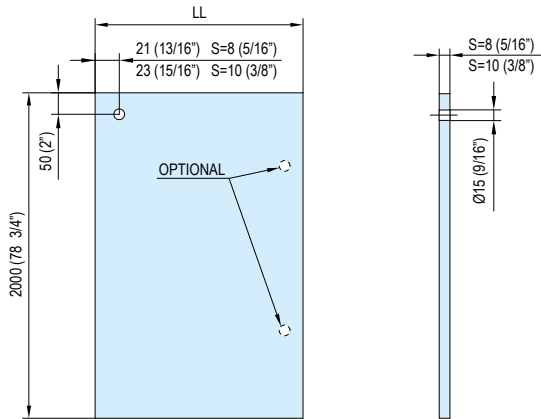
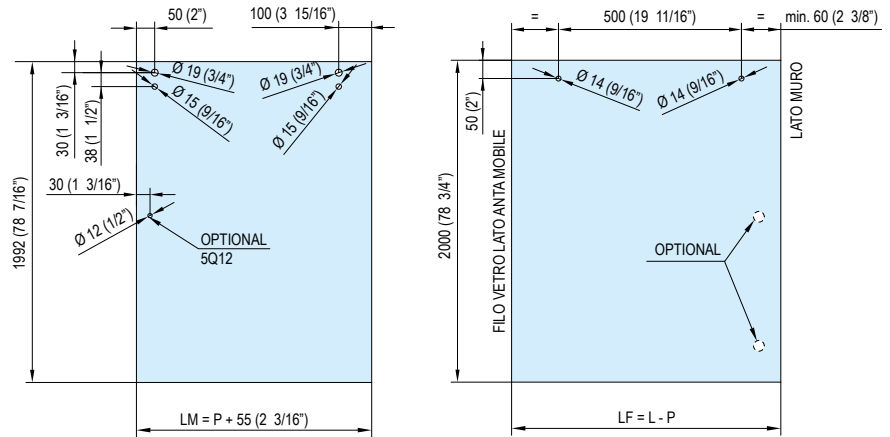

1 $\varnothing 20 \times 1,5$
(13/16" x 1/16")

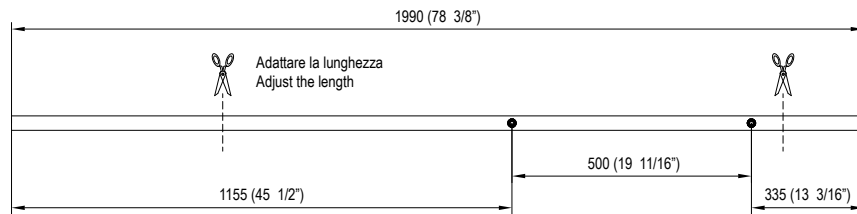

2 20x20x1,5
(13/16" x 13/16" x 1/16")

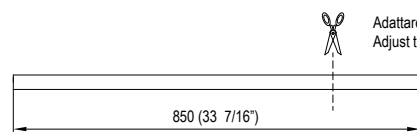

BZQ7

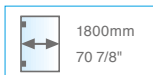
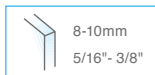

• Kit Hip-zac per box doccia con 1 spalla in vetro da 1200 a 1800mm. Sezione quadrata.

• Kit Hip-zac para box ducha: un lado en vidrio desde 1200 a 1800mm. Sección cuadrada.

• Hip Zac kit with 1 fixed glass panel 1200-1800mm. Square section.

• Schiebetürsystem Hip Zac mit 1 starren Glasplatte 1200-1800mm. Vierkantschnitt.

• Kit Hip-zac pour cabine de douche avec 1 retour en verre de 1200 à 1800mm. Section carrée.

HIP-ZAC system

BZQ7K

composto da / composed of



2 x BZ10Q



1 x BZ51



1 x BZ30Q



1 x BZ90Q



1 x BZ60



2 x BZ70Q



1 x BZ80Q

+

BZQK43

composto da / composed of



1 x BZ58

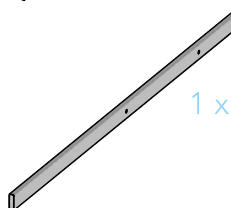

1 x BZ43Q

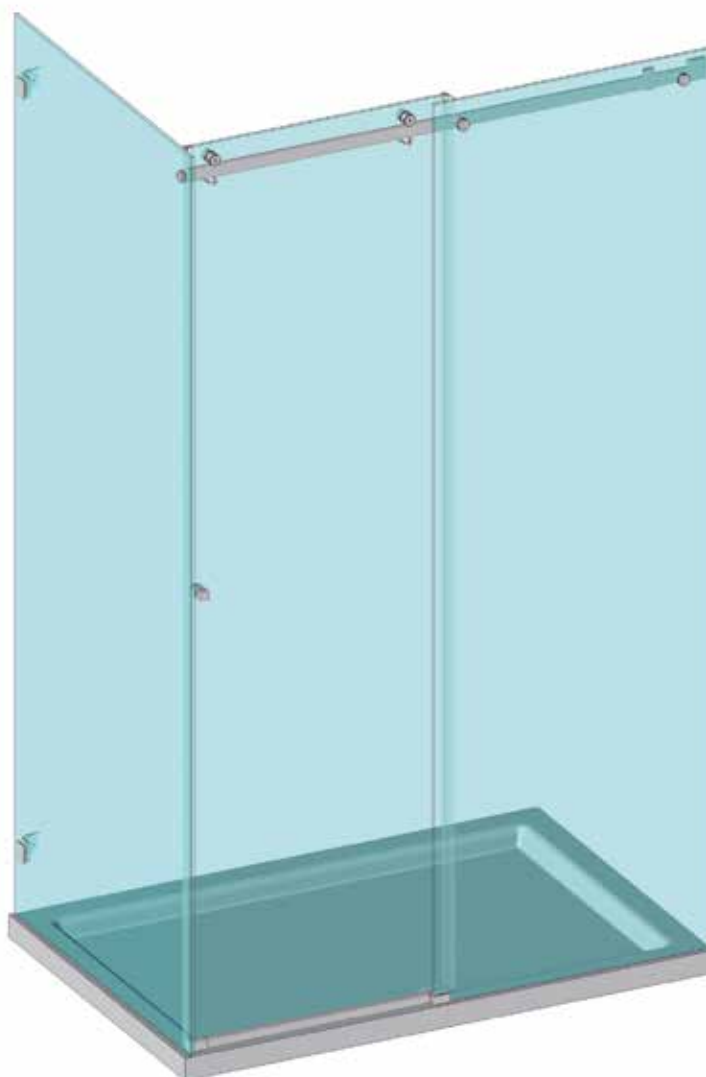

BZQ7

HIP-ZAC system

DATI (Data)	L = min 1200 ÷ max 1800	(mm)
DEFINIRE (Define)	P = min 450 ÷ max (L/2-55)	(mm)
CALCOLARE (Calculate)	LM = (P+55)	(mm)
CALCOLARE (Calculate)	LF = (L-P)	(mm)
DEFINIRE (Define)	LL	(mm)

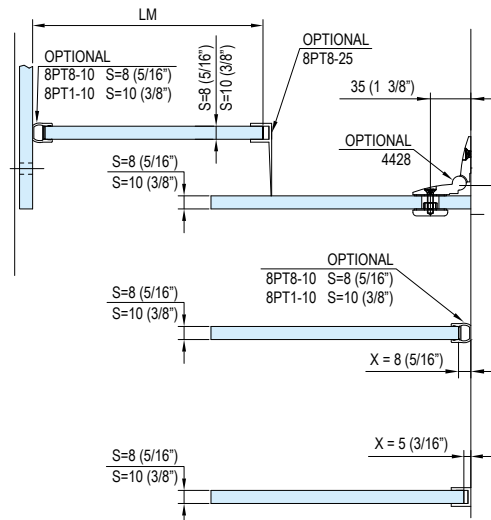
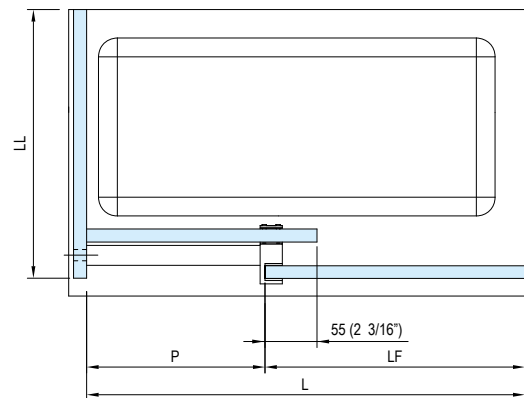
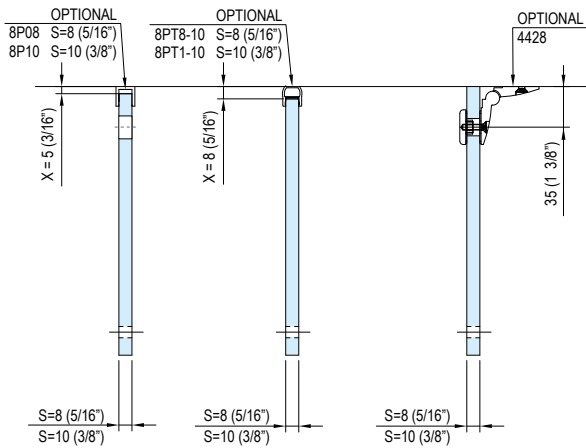
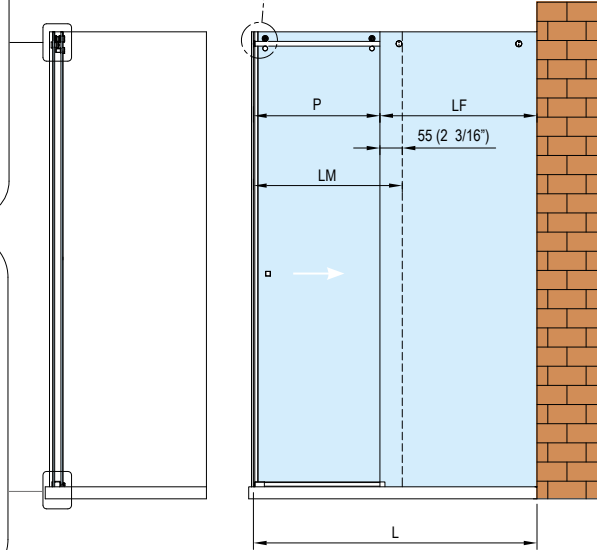
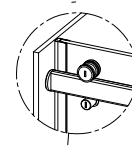
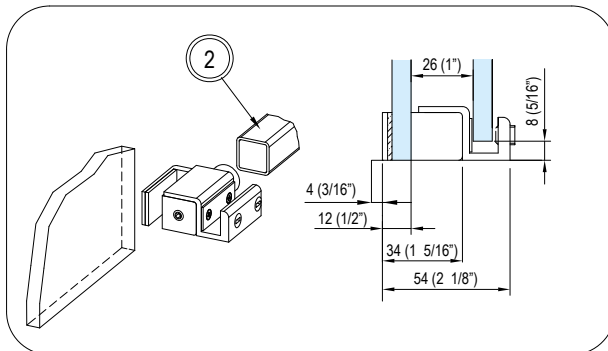
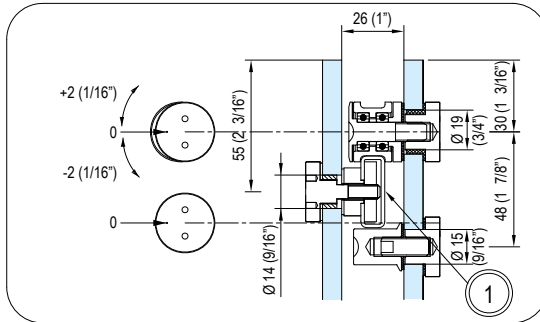

BZQ7

HIP-ZAC system

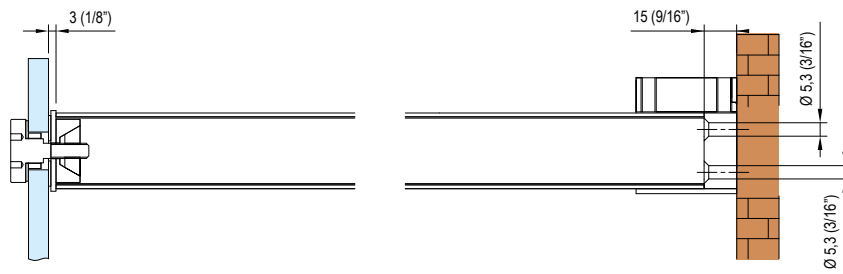
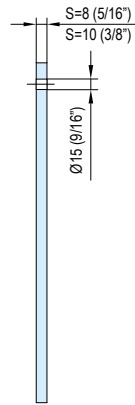
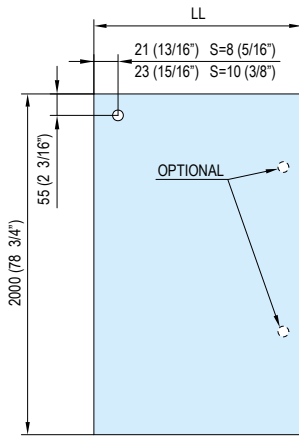
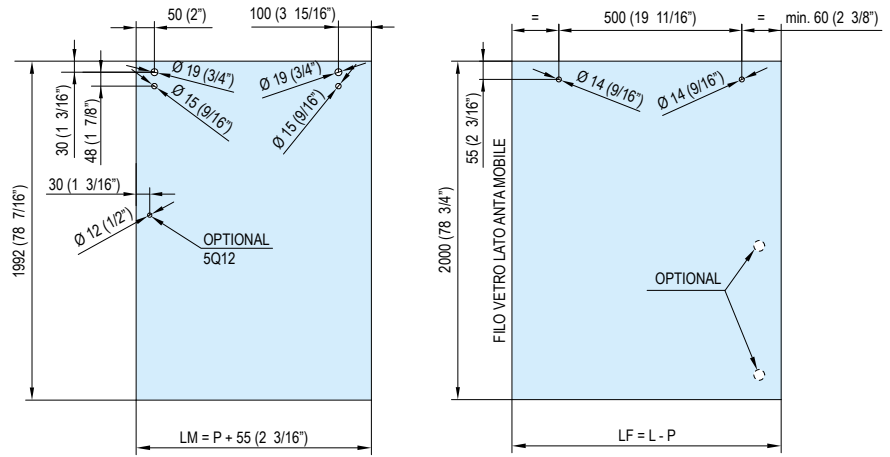

1 30x10x1,5
(1 3/16" x 3/8" x 1/16")

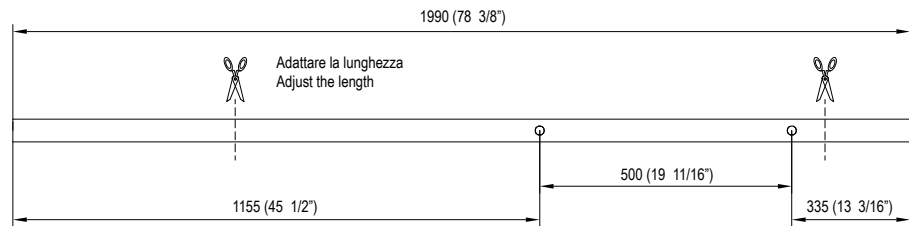

2 20x20x1,5
(13/16" x 13/16" x 1/16")

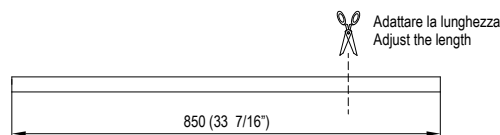

BZ09

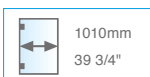
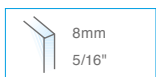

• Kit Hip-zac per sopravasca da 1000 a 2000mm. Sezione tonda.

• Kit Hip-zac para bañera desde 1000 a 2000mm. Sección redonda.

• Hip Zac kit for bath-tubs 1000-2000mm. Round section.

• Schiebesystem Hip Zac für Badewanne 1000-2000mm. Rundschnitt.

• Kit Hip-zac - Paroi de baignoire de 1000 à 2000mm. Section ronde.

HIP-ZAC system

BZ09K composto da / composed of



2 x BZ10



1 x BZ30



2 x BZ90



2 x BZ70

+

BZ0K49 composto da / composed of



1 x BZ49

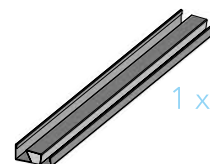

1 x BZ59



BZ09

HIP-ZAC system

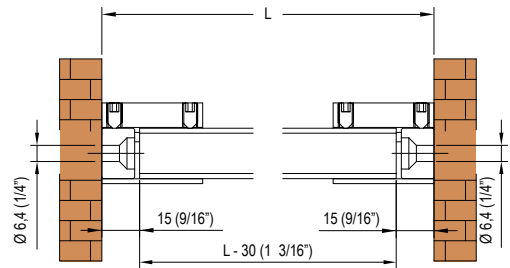
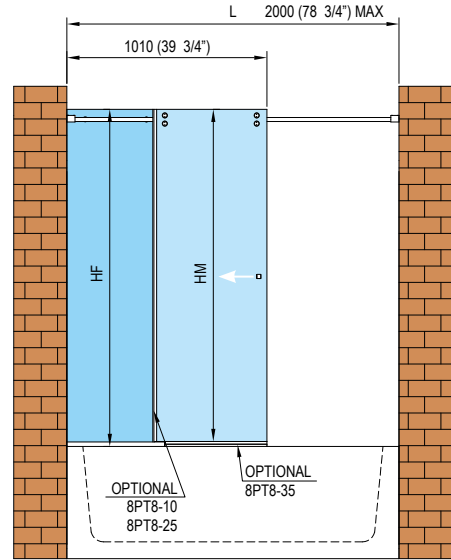
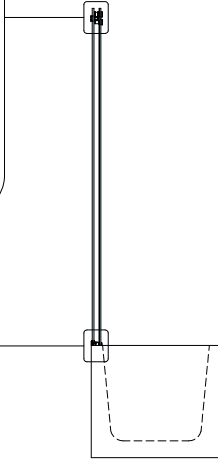
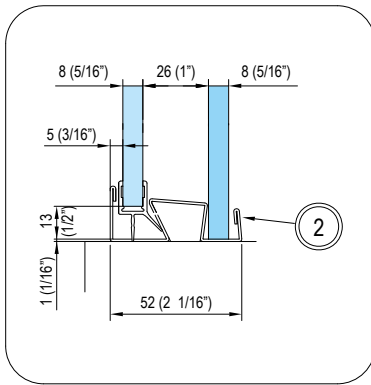
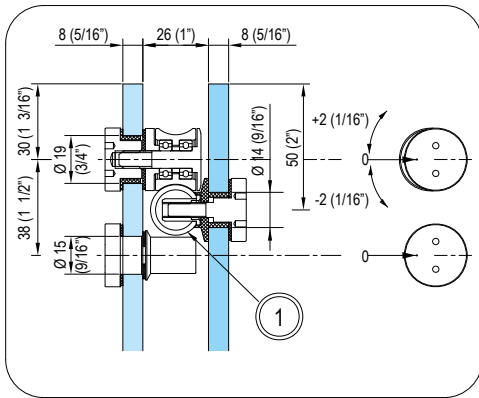

1 $\varnothing 20 \times 2$
(13/16" x 1/16")

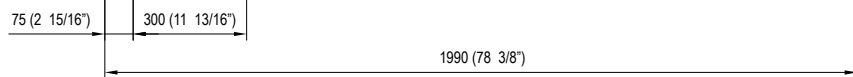

Adattare la lunghezza
Adjust the length

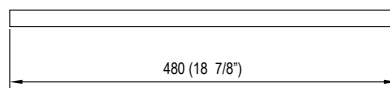
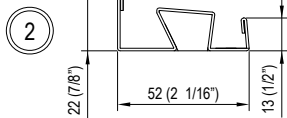

BZ09

HIP-ZAC system

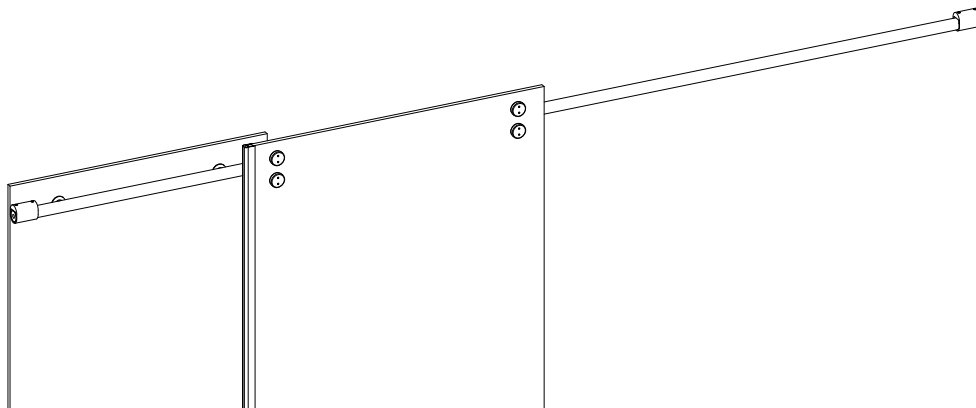
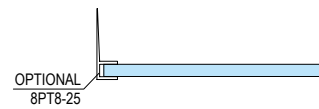
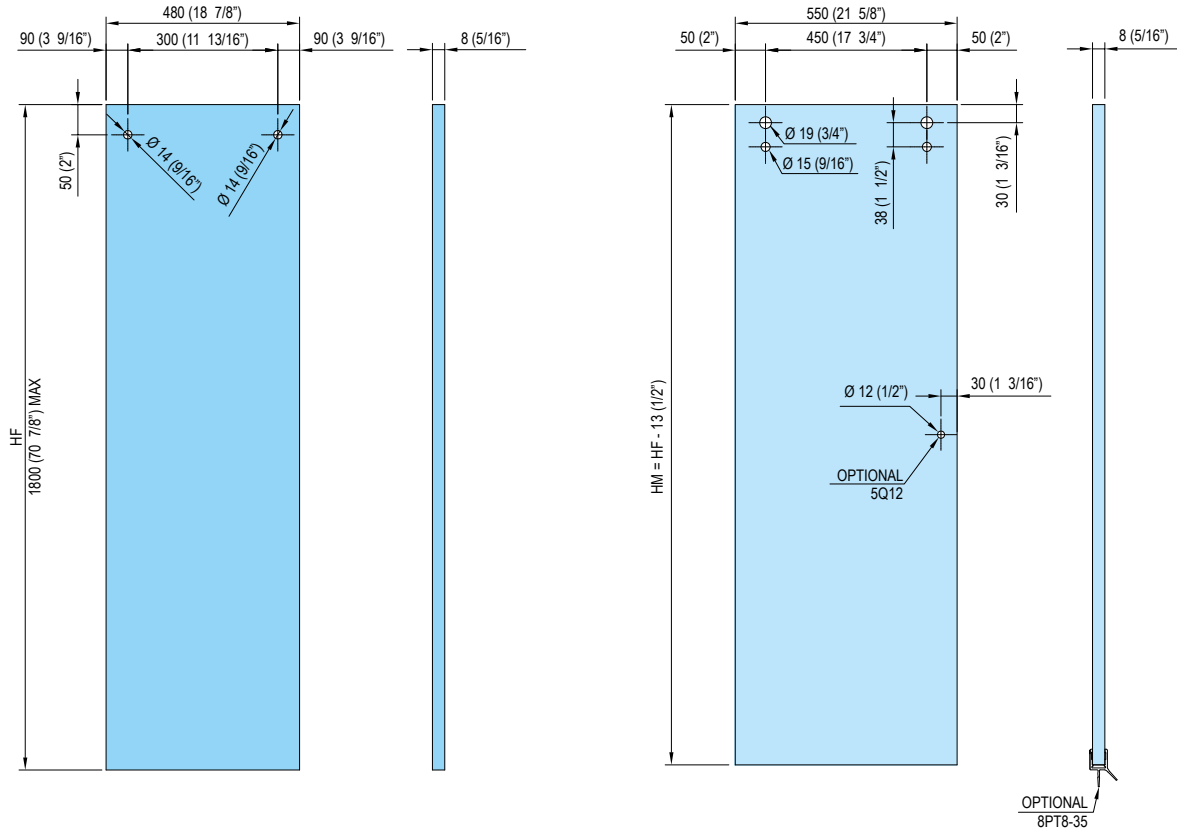

BZQ9

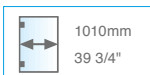
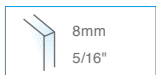

• Kit Hip-zac per sovravasca da 1000 a 2000mm. Sezione quadrata.

• Kit Hip-zac para bañera 1000-2000mm. Sección cuadrada.

• Hip Zac kit for bath-tubs 1000-2000mm. Square section.

• Schiebesystem Hip Zac für Badewanne 1000-2000mm. Vierkantschnitt.

• Kit Hip-zac – Paroi de baignoire de 1000 à 2000mm. Section carrée.

BZQ9K composto da / composed of



2 x BZ10Q



1 x BZ30Q



2 x BZ90Q



2 x BZ70Q

+

BZQK49 composto da / composed of

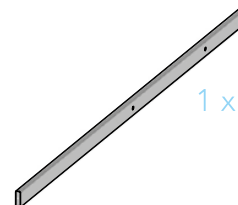

1 x BZ49Q

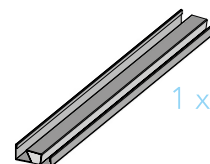

1 x BZ59

HIP-ZAC system

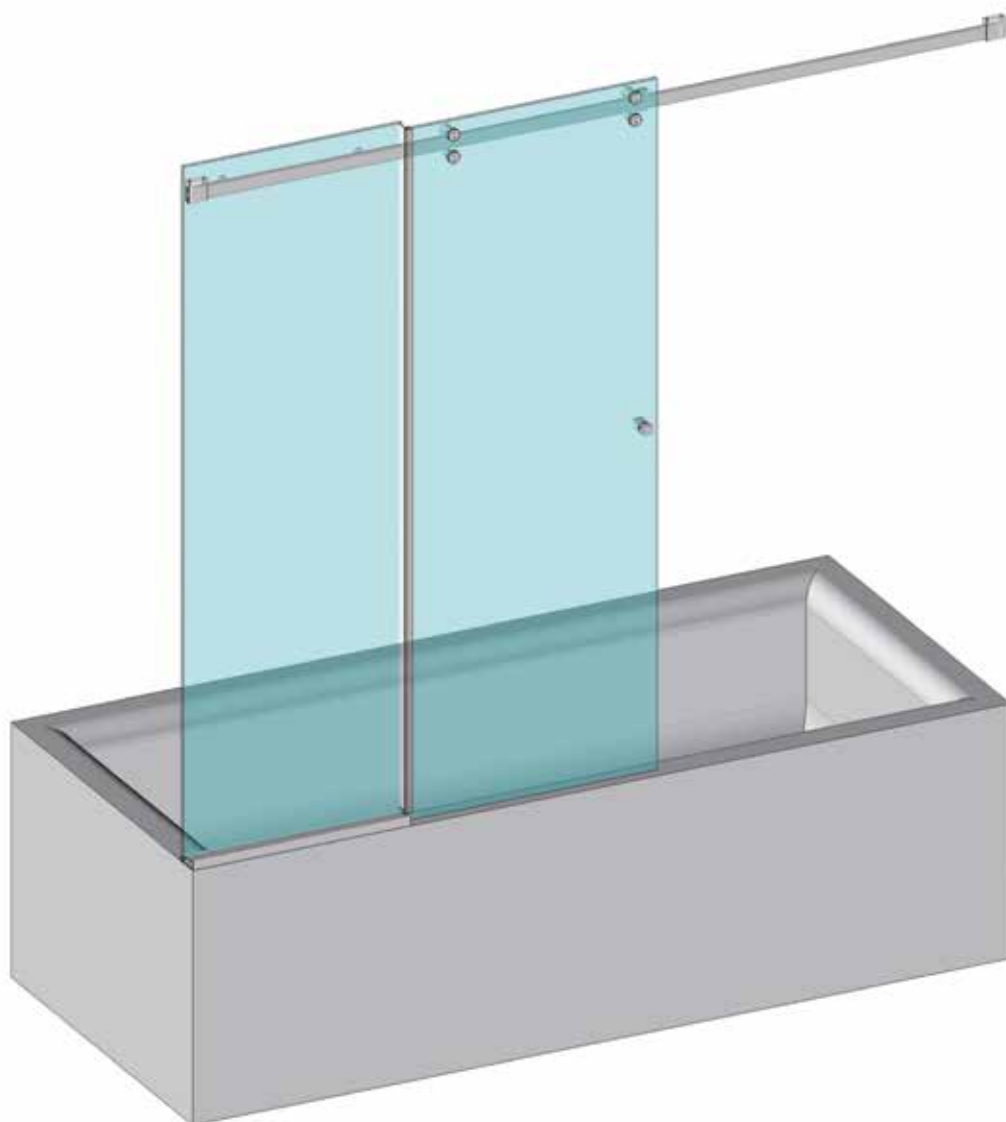

BZQ9

HIP-ZAC system

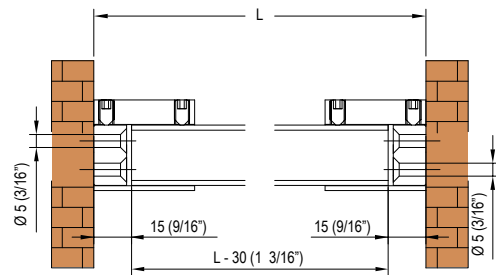
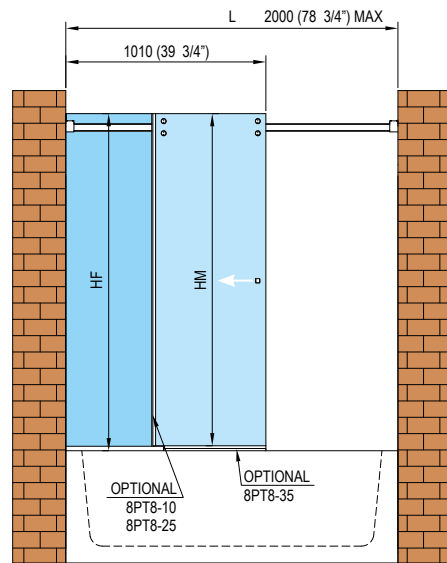
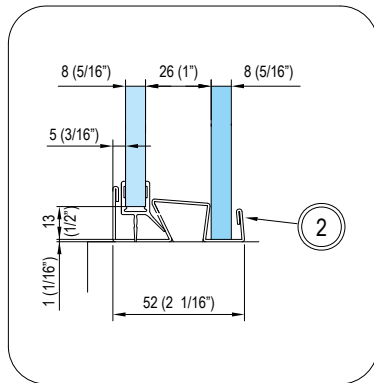
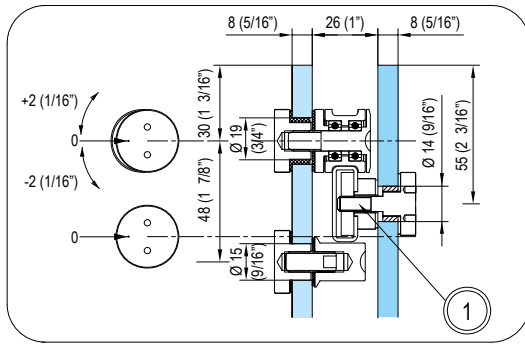

1 30x10x1,5
(1 3/16" x 3/8" x 1/16")

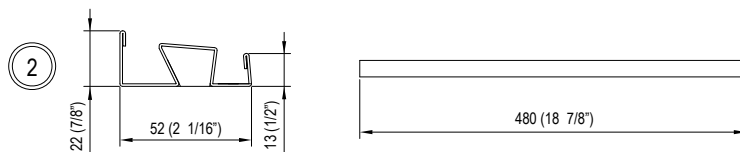
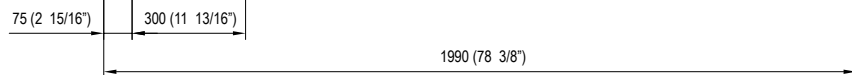

BZQ9

HIP-ZAC system

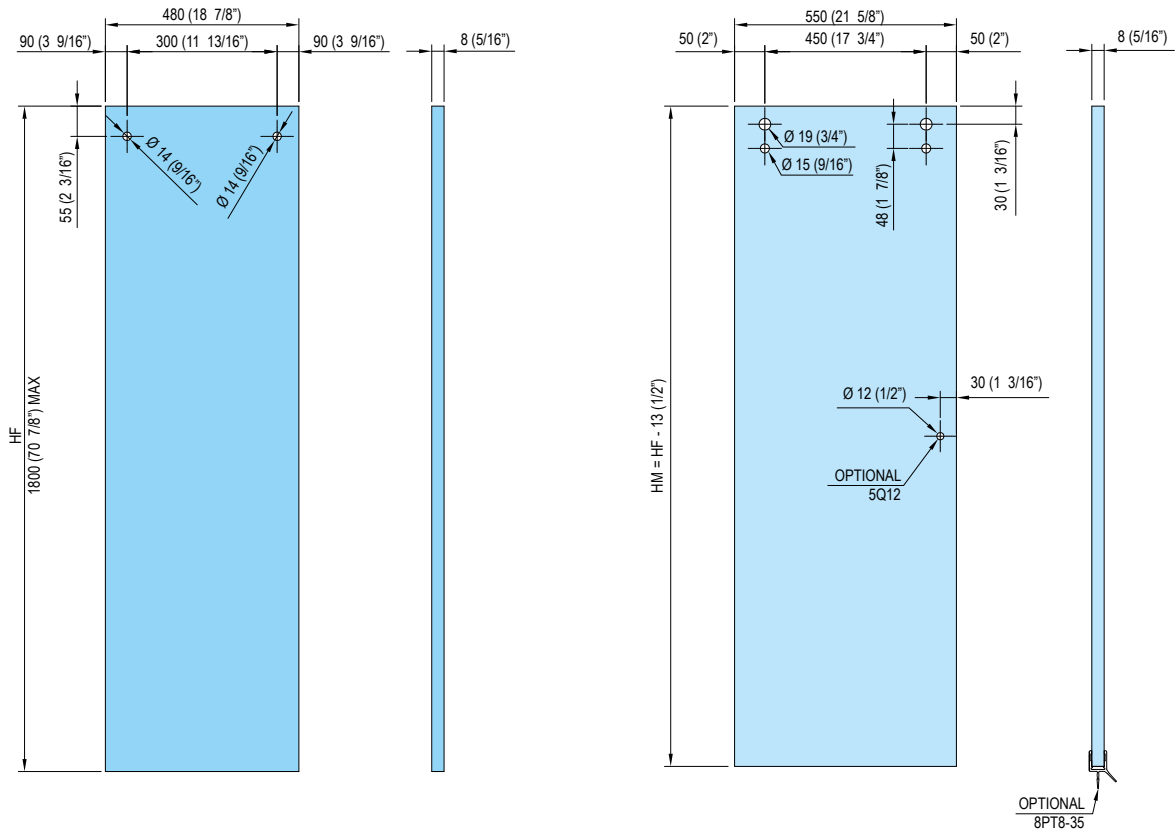

OPTIONAL 8PT8-10



OPTIONAL 8PT8-25

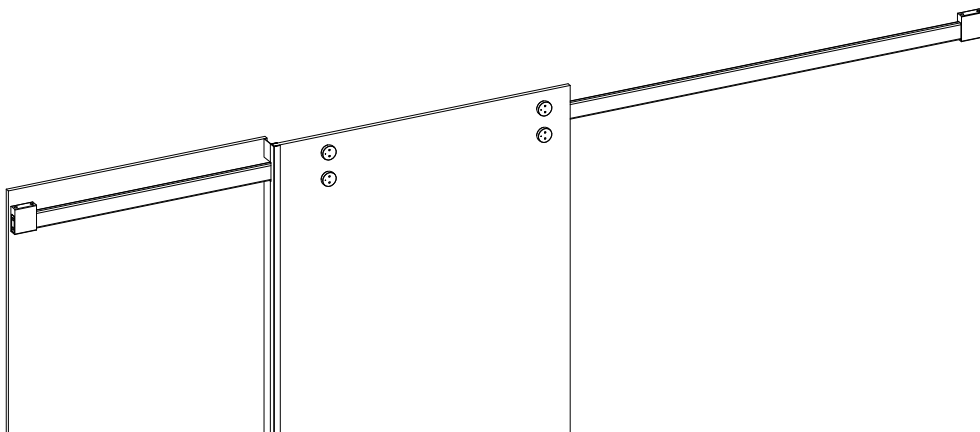

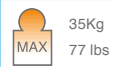

4428

HIP-ZAC system

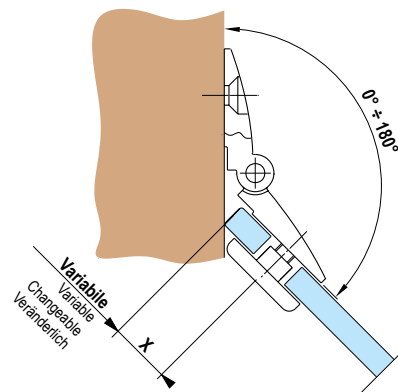
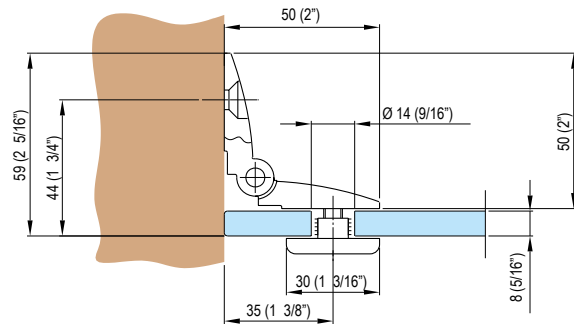
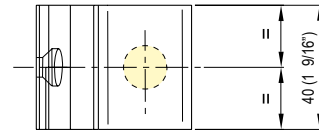
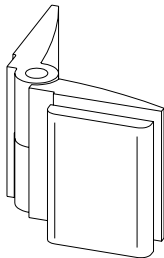

- Angolare muro-velro regolabile.
- Angular regulable pared-vidrio.
- Angular fitting wall to glass.
- Einstellbares Winkelverbinder Wand-Glas.
- Équerre mur-verre réglable.



4429

HIP-ZAC system

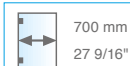
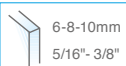

- Angolare vetro-vetro regolabile.
- Angular vidrio-vidrio regulable.
- Adjustable angular fitting glass to glass.
- Einstellbares Winkelverbinder Glas-Glas.
- Équerre verre-verre réglable.

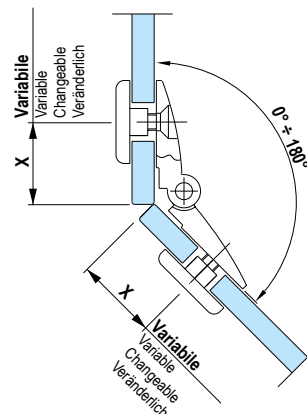
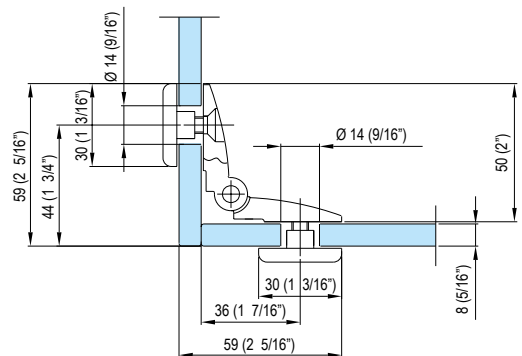
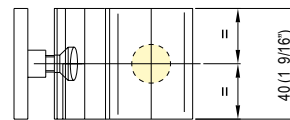
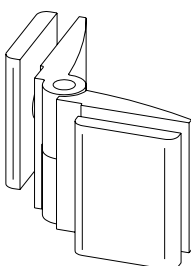

5Q12

HIP-ZAC system

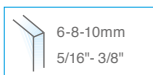

- Coppia pomoli 20x20mm.
- Juego de pomos 20x20mm.
- Pair of knobs 20x20mm.
- Paar Türknöpfe 20x20mm.
- Paire de poignées carrées 20x20mm.

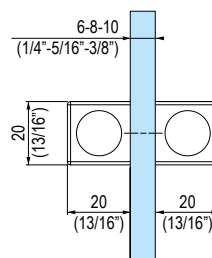
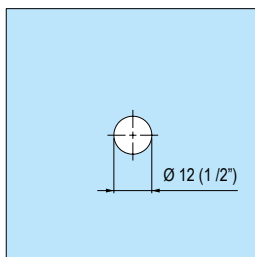
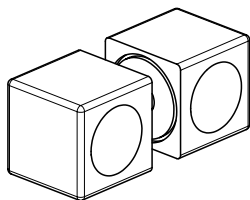

sistemi / systems

kit **Box Curvo**



Sistema per box doccia curvo con ante semicircolari a due battenti. Viene fornito su richiesta, anche completo dei vetri curvi. Design minimale ma elegante, si adatta per dimensioni ai piatti doccia più diffusi.

Sistema de mampara de baño curvo con puertas semicirculares dobles. Sobre pedido, también con los vidrios curvados. Diseño minimalista pero elegante, se adapta a los platos de ducha más comunes.

System for curved shower enclosure with half-round double doors. It is available on demand, and also with curved glazings. Essential but

Alluminio / Aluminium - finiture / colors 13-14-15-60-62

elegant design, suitable with the most widespread shower plates.

Neues System für Duschen für gebogenes Glas mit zwei halbkreisförmigen Flügeln. Auf Anfrage und eventuell komplett von gebogenen Gläsern lieferbar. Elegantes Minimal Design und verwendbar mit den meisten weitverbreiteten Duschplatten.

Système pour cabine de douche bombée avec portes doubles semi-circulaires. Disponible sur demande, ce système existe aussi avec des verres incurvés. Un design minimaliste et élégant qui s'adapte à la plupart de vos configurations.



BC8411N

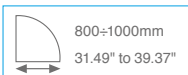
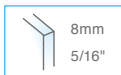

• Kit box curvo per piatto doccia da 800 a 1000mm.

• Kit para box ducha desde 800 hasta 1000mm.

• Kit for curved shower boxes for plates from 800 till 1000 mm.

• Kit für gebogene Duschkabinen von 800 bis zu 1000 mm.

• Kit pour cabine de douche incurvée pour des plaques de 800 à 1000mm.

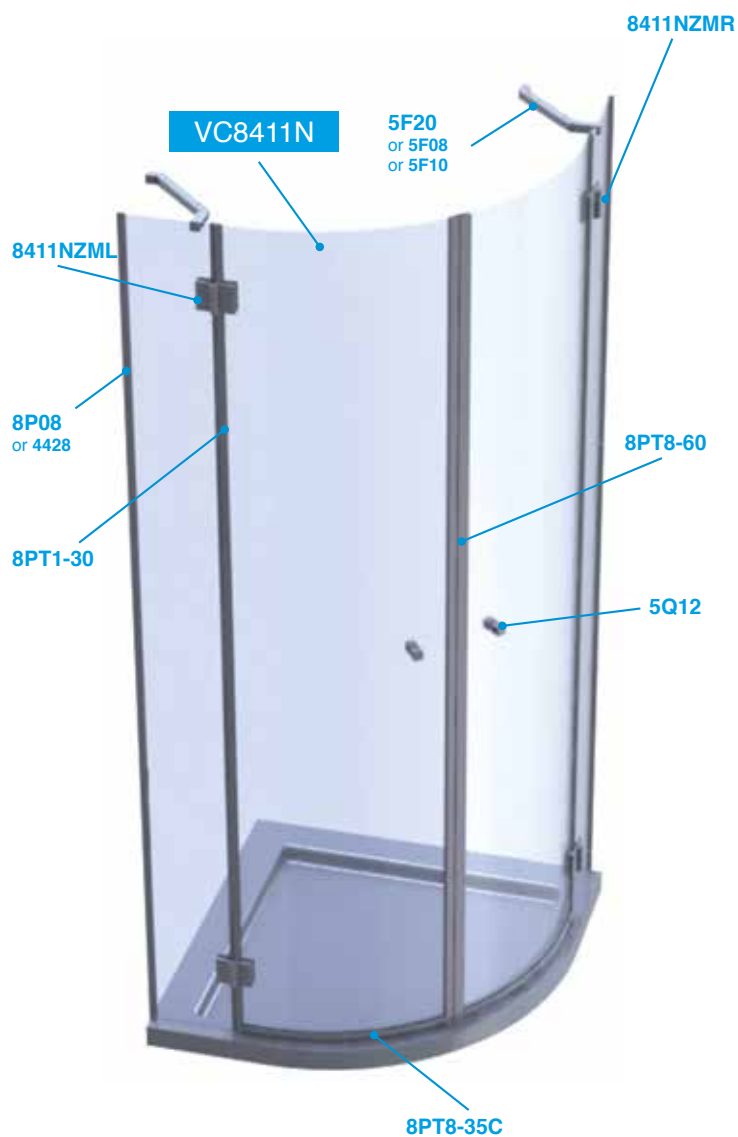

Compresso

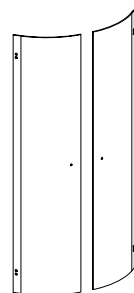

1X
VC8411N



2X
8411NZMR



2X
8411NZML

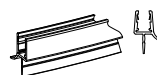

2X
8PT835-C

In Kit

Non compresso

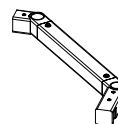

2X
5F20 or
5F08 or 5F10



2X
5Q12



4X
4428



2X
8P08
(2,2mt inox)



2X
8PT1-30
(2,5mt pvc)

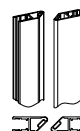

2X
8PT8-60
(2,2mt pvc)

Out kit

BC8411N

SOLUZIONE 1

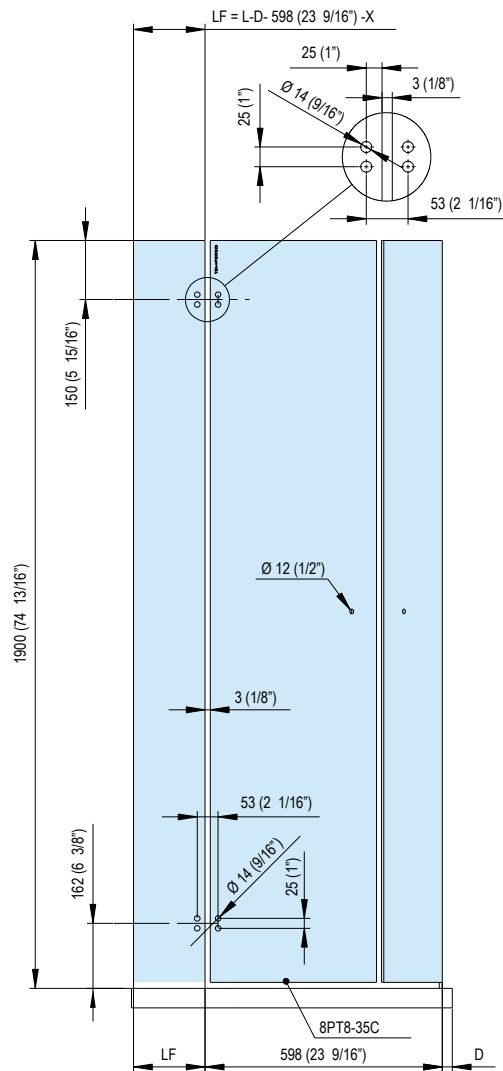

SOLUZIONE 2

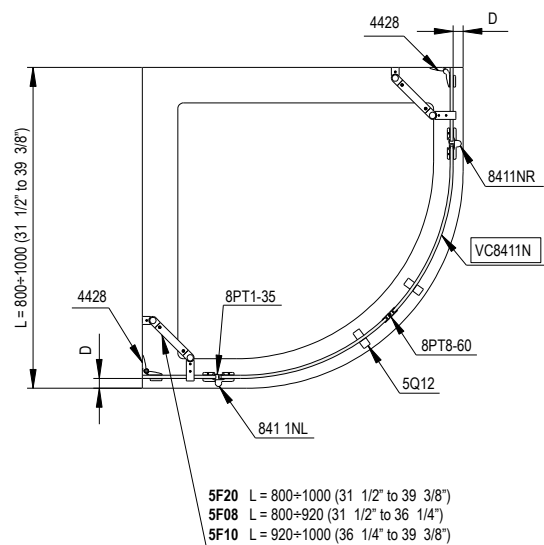
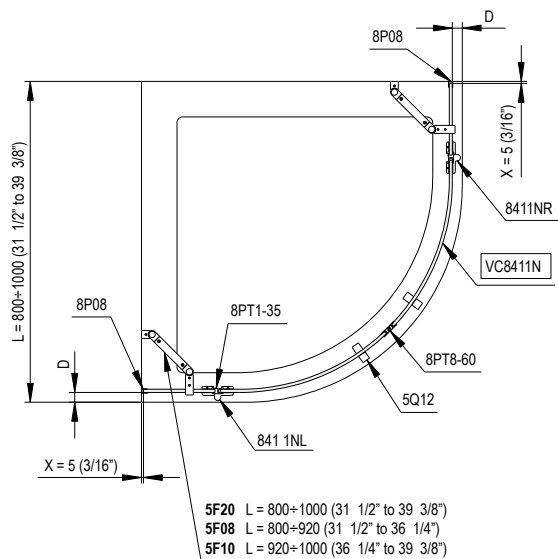
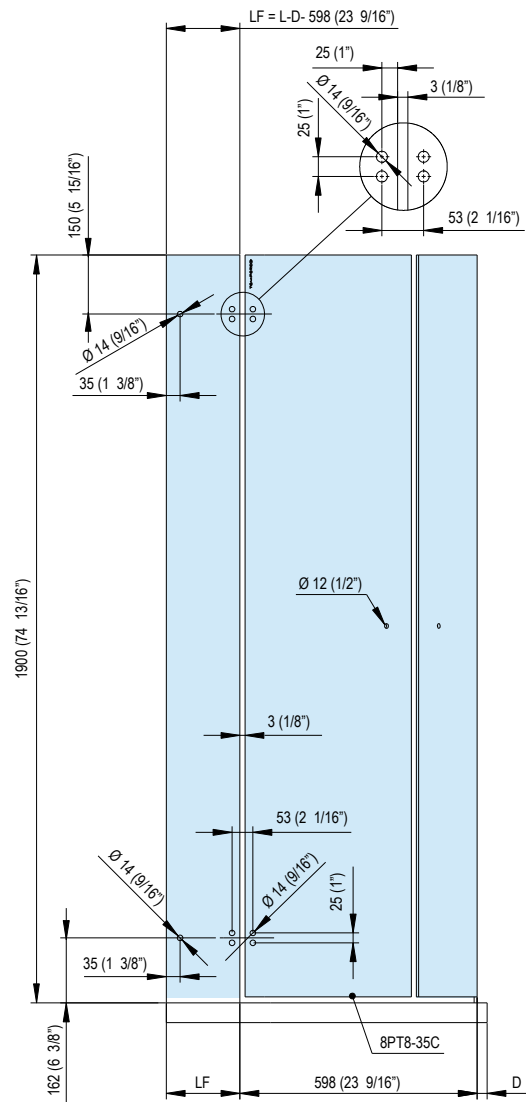

VC8411N



- Coppia vetri curvi temperati per box doccia da 800 a 1000mm. Float chiaro.
- Pareja vidrios curvos templados para box ducha desde 800 hasta 1000mm. Float claro.
- Pair of tempered glasses for curved shower box from 800 till 1000 mm. Clear float.
- Paar gehärtete, gebogene Gläser für Duschkabinen von 800 bis zu 1000 mm. Transparent Float Glas.
- Paire de panneaux en verre trempé courbe pour cabine de douche de 800 à 1000mm. Verre flotté transparent.

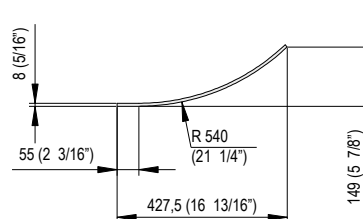
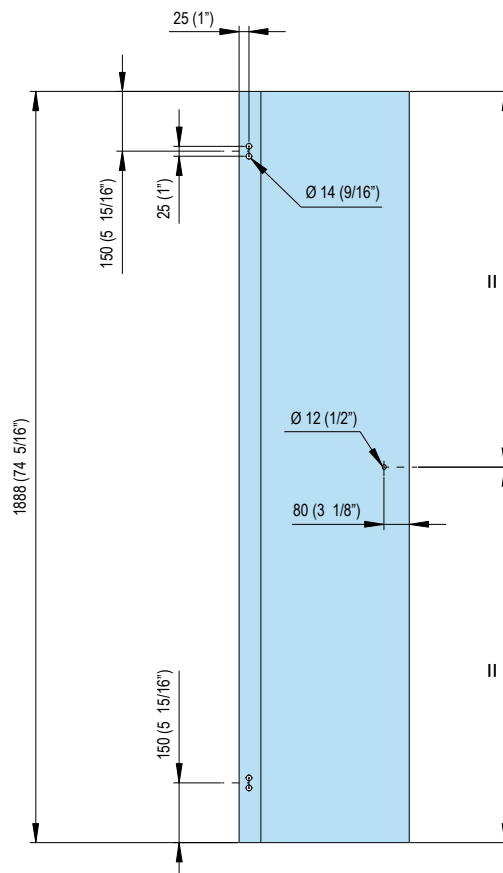
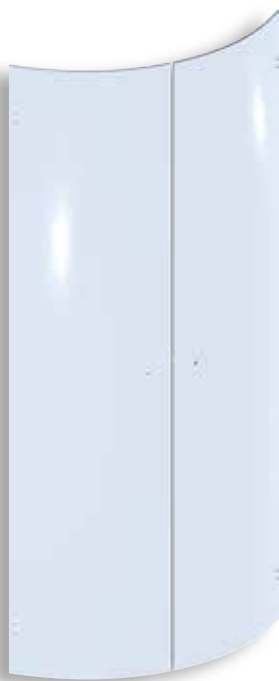

angolari e morsetti / angular fitting and clamps

Zama / Zamak 	Zama / Zamak 	Zama / Zamak 	Zama / Zamak 	Alluminio / Aluminium 
4410 finiture / colors 14-60-62	4411 finiture / colors 14-60-62	4414 finiture / colors 14-60-62	4415 finiture / colors 14-60-62	4428 finiture / colors 13-14-15-16-17-60-62
Alluminio / Aluminium 	Ottone / Brass 	Ottone / Brass 		
4429 finiture / colors 13-14-15-16-17-60-62	4500 finiture / colors 13-14-15-16-17-60-62	4502 finiture / colors 13-14-15-16-17-60-62		

pomoli e maniglie / knobs and handles

Alluminio / Aluminium 	Alluminio / Aluminium 	Alluminio / Aluminium 	Alluminio / Aluminium 	Alluminio / Aluminium 
5400 finiture / colors 13-14-15-16-17-60-62	5Q12 finiture / colors 13-14-15-60-62	5401 finiture / colors 13-14-15-16-17-60-62	5410 finiture / colors 02-05 13-14-15-16-17-60-62	506W30 finiture / colors 13-14-60-62
Alluminio / Aluminium 	Acciaio Inox / Stainless Steel 	Acciaio Inox / Stainless Steel 	Acciaio Inox / Stainless Steel 	Acciaio inox / Stainless Steel 
5A00 finiture / colors 05-13 14-15-16-17-60-62	5C00 finiture / colors 31-32-60-62	5H01 finiture / colors 31-32-60-62	5H03 finiture / colors 31-32-60-62	502W30 finiture / colors 31-32-60-62
Alluminio / Aluminium 				Acciaio inox / Stainless Steel 
515E30 finiture / colors 13-14 15-16-17-60-62				504W30 finiture / colors 31-32-60-62

4410

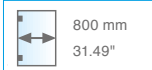
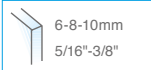

- Angolare muro-vetro.
- Angular pared-vidrio.
- Angular fitting wall to glass.
- Winkelverbinder Wand-Glas.
- Équerre mur-verre.

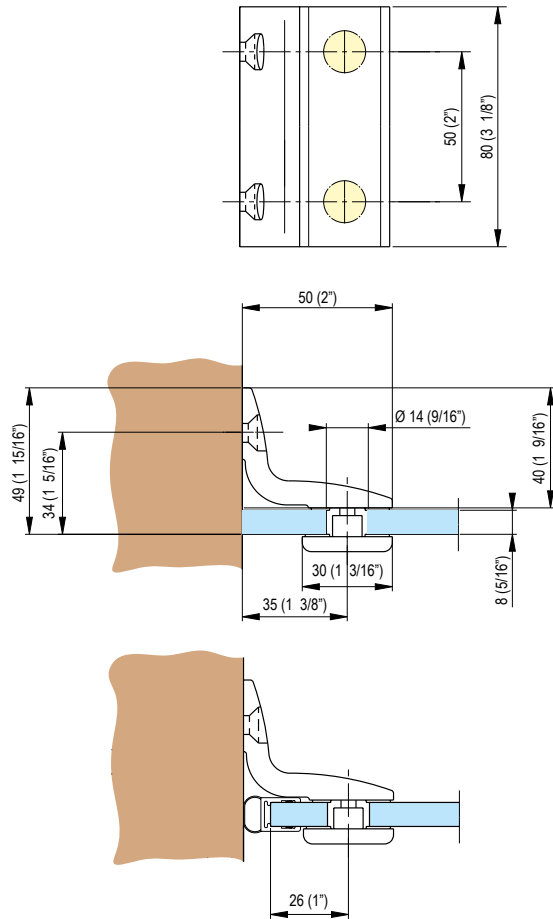
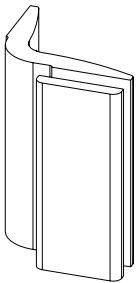

4411

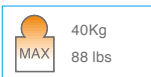
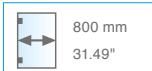
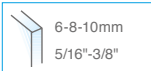

- Angolare vetro-vetro 90°.
- Angular vidrio-vidrio 90°.
- Angular fitting glass to glass 90°.
- Winkelverbinder Glas-Glas 90°.
- Équerre verre-verre 90°.

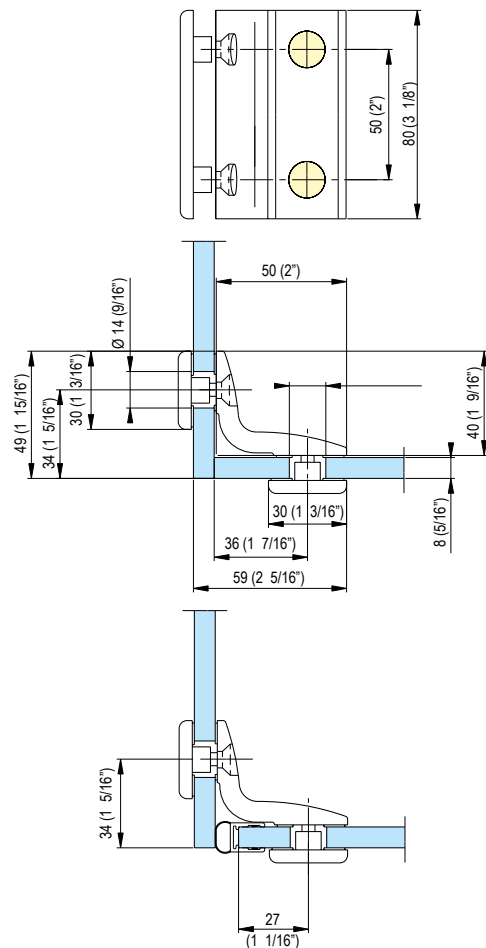
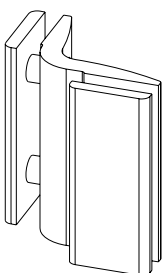

4414

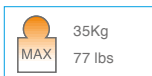
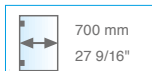
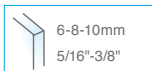

- Angolare piccolo muro-vetro.
- Angular pequeño pared-vidrio.
- Small angular fitting wall to glass.
- Kleiner Winkelverbinder Wand-Glas.
- Équerre mur-verre.

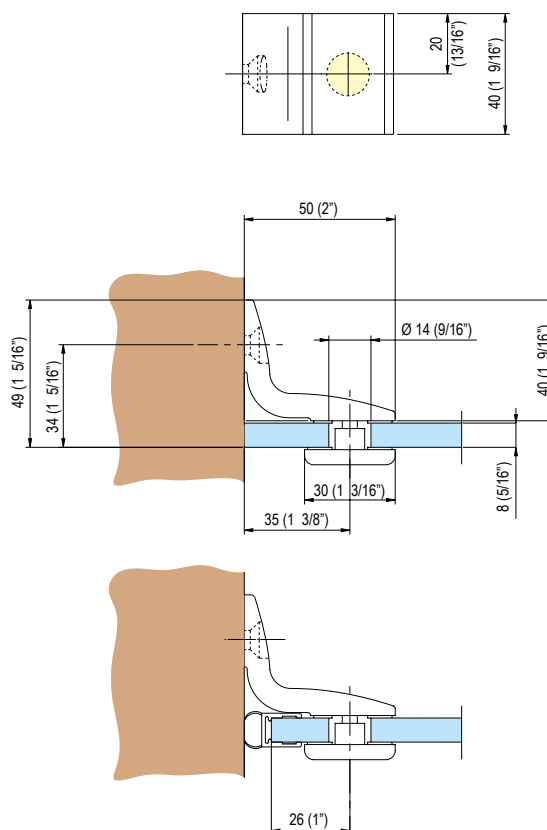
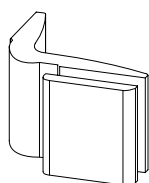

4415

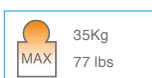
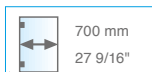
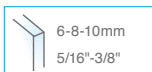

- Angolare piccolo vetro-vetro 90°.
- Angular pequeño vidrio-vidrio 90°.
- Small angular fitting glass to glass 90°.
- Kleiner Winkelverbinder Glas-Glas 90°.
- Petite équerre verre-verre 90°.

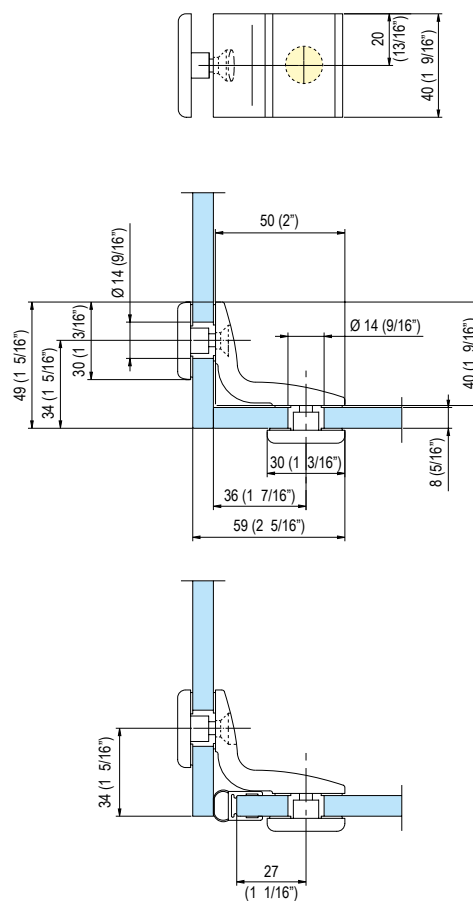
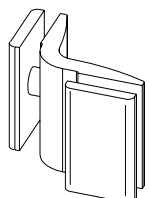

4428

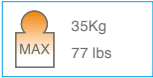
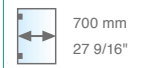
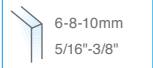

- Angolare muro-velro regolabile.
- Angular regulable pared-vidrio.
- Angular fitting wall to glass.
- Einstellbarer Winkelverbinder Wand-Glas.
- Équerre mur-verre réglable.

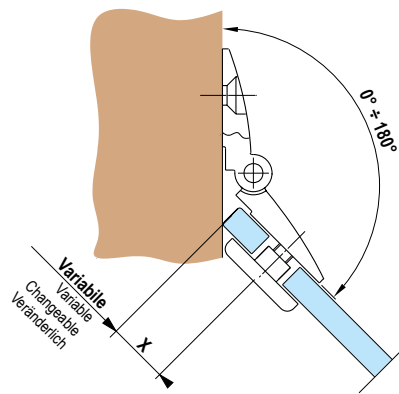
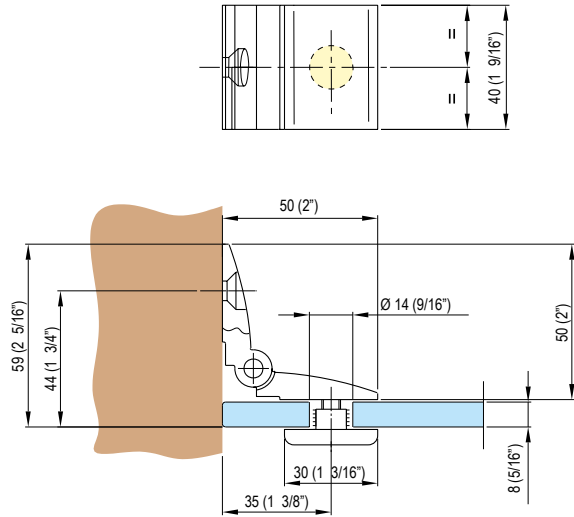
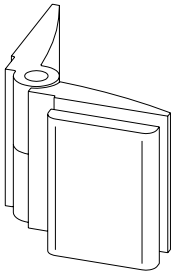

4429

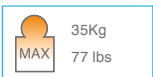
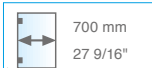
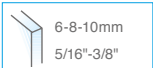

- Angolare vetro-vetro regolabile.
- Angular vidrio-vidrio regulable.
- Adjustable angular fitting glass to glass.
- Einstellbarer Winkelverbinder Glas-Glas.
- Équerre verre-verre réglable.

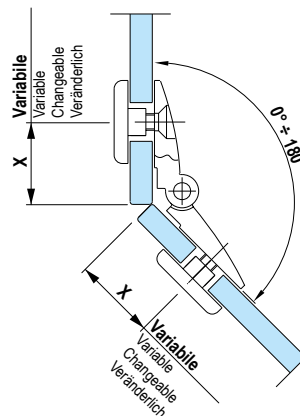
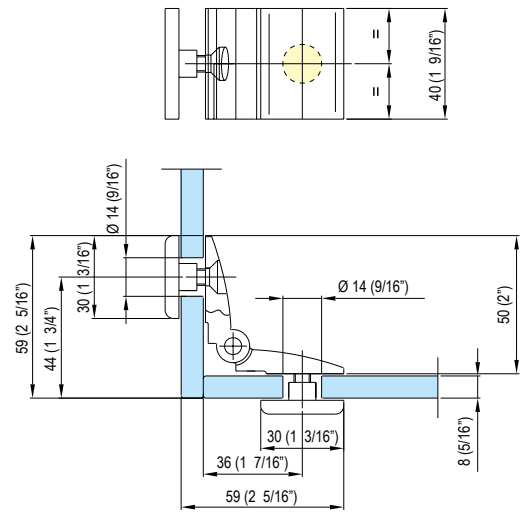
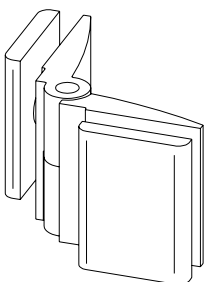

4500

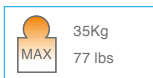
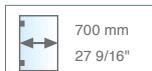
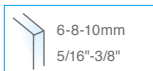

- Morsetto piccolo per box doccia.
- Fijación pequeña para box ducha.
- Small clamp for shower boxes.
- Kleiner Glasplattenträger für Duschkabinen.
- Petite pince pour cabine de douche.

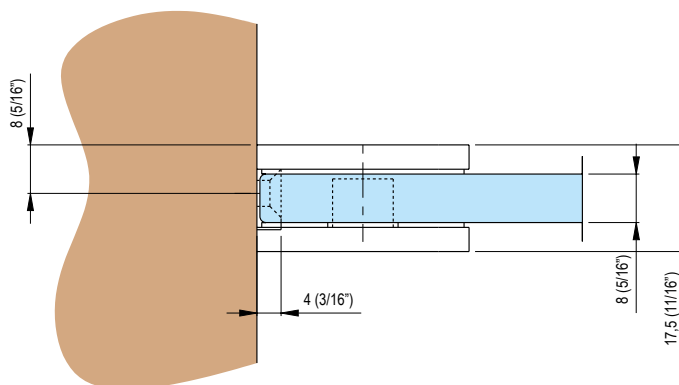
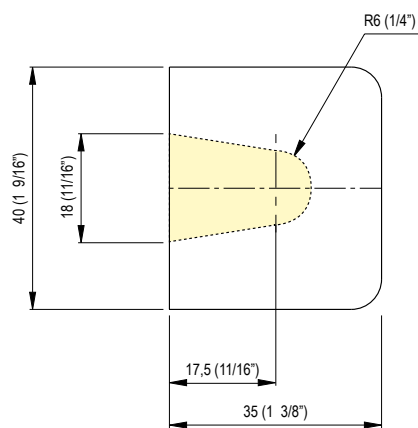
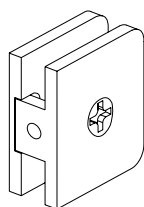

4502

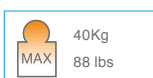
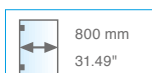
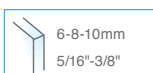

- Morsetto per box doccia.
- Fijación para box ducha.
- Clamp for shower boxes.
- Glasplattenträger für Duschkabinen.
- Pince pour cabine de douche.

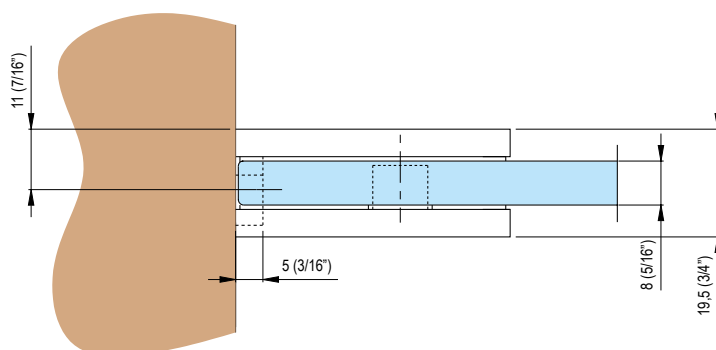
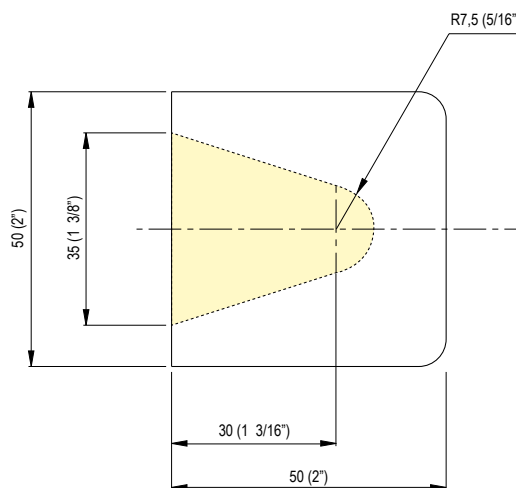
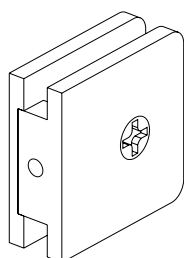





5400



- Coppia pomoli. Diametro 25mm.
- Juego de pomos. Diámetro 25mm.
- Pair of door knobs. Diameter 25mm.
- Paar Duschtürkнопfe. Durchmesser 25mm.
- Poignée double. Diamètre 25mm.

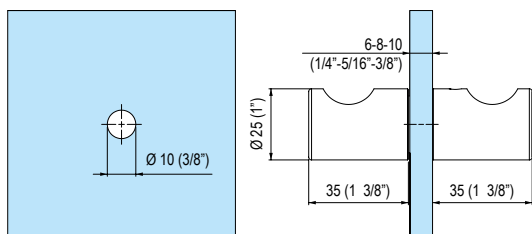
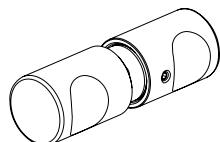

5Q12



- Coppia pomoli 20x20 mm.
- Juego de pomos 20x20 mm.
- Pair of door knobs 20x20 mm.
- Paar Türkнопfe 20x20 mm.
- Poignée double 20x20 mm.

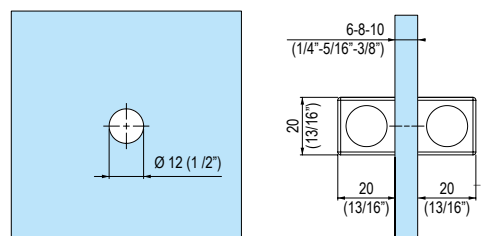
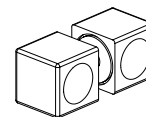

5401

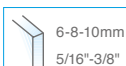

- Coppia pomoli. Diametro 48mm.
- Juego de pomos. Diámetro 48mm.
- Pair of door knobs. Diameter 48mm.
- Paar Duschtürkнопfe. Durchmesser 48mm.
- Poignée double. Diamètre 48mm.

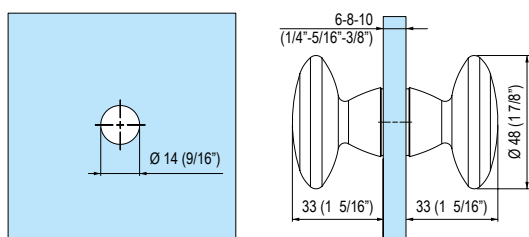
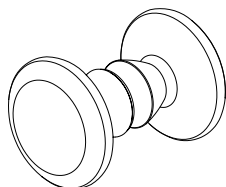

5410

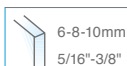

- Coppia pomoli. Diametro 48mm.
- Juego de pomos. Diámetro 48mm.
- Pair of door knobs. Diameter 48mm.
- Paar Duschtürkнопfe. Durchmesser 48mm.
- Poignée double. Diamètre 48mm.

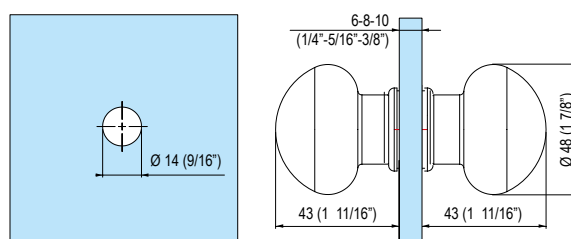
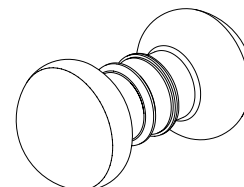

515E30

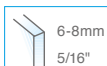

- Coppia di maniglie per box doccia.
- Juego de tiradores para mampara de baño.
- Pair of handles for shower box.
- Paar Duschtürdrücker.
- Couple de poignées pour la douche.

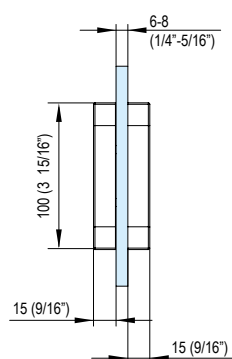
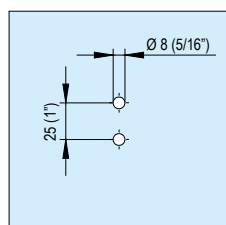

502W30

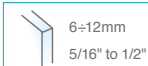

- Coppia maniglioni dritti, sezione quadra. Interasse 254mm.
- Juego de tiradores, sección cuadrada. Distancia entre ejes 254mm.
- Pair of handles, square section. Centre distance 254mm.
- Gerades Stoßgriffpaar, quadratische Ausführung. Achsenabstand 254mm.
- Couple de poignées droites, section carrée. Entraxe 254mm.

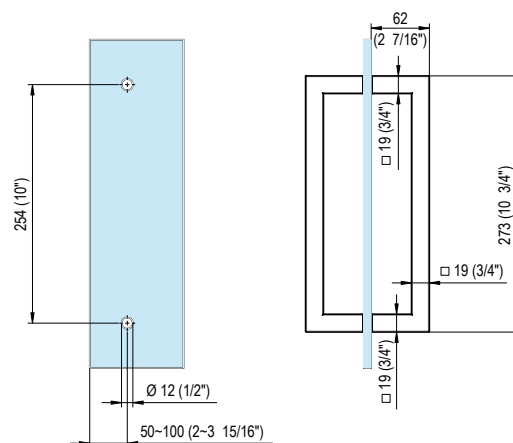

504W30

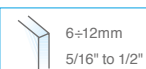

- Coppia maniglioni dritti, impugnatura piatta. Interasse 254mm.
- Juego de tiradores, agarre lisa. Distancia entre ejes 254mm.
- Pair of handles, flat handgrip. Centre distance 254mm.
- Gerades Stoßgriffpaar, flache Ausführung. Achsenabstand 254mm.
- Couple de poignées droites, poignée plate. Entraxe 254mm.

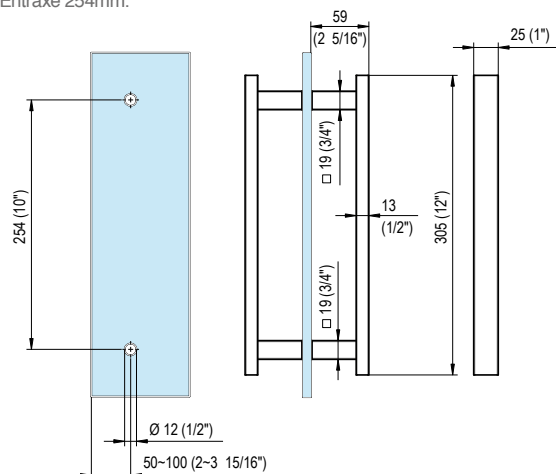
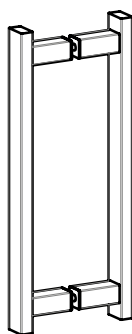

506W30

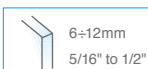

- Coppia pomoli.
- Juego de pomos.
- Pair of knobs.
- Türkнопfpaar quadratisch.
- Couple de boutons.

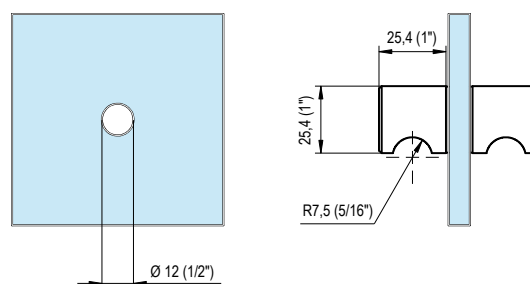

5A00

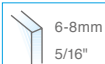

- Coppia pomoli Ala system.
- Juego de pomos Ala system.
- Ala system knobs.
- Paar Kugelgriff Ala System.
- Poignée double.

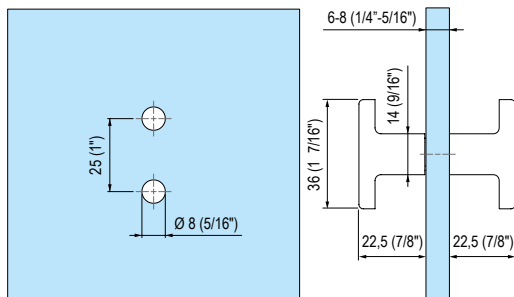
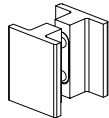

5C00



- Maniglia interasse 170mm Inox.
- Tirador. Distancia entre ejes 170mm. Inoxidable.
- Handle centre distance 170mm. Stainless steel.
- Türdrücker. Achsenabstand 170mm. Edelstahl.
- Poignée entraxe 170mm. Inox.

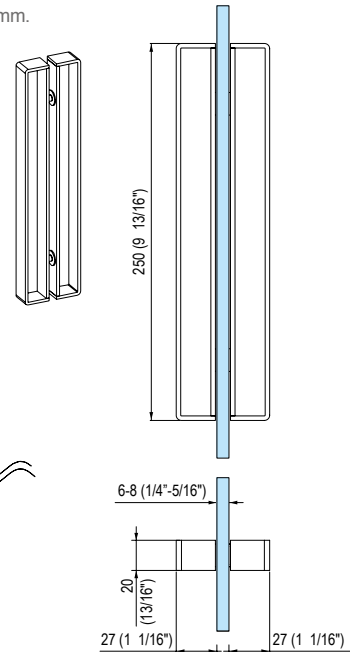

5H01



- Coppia maniglioni dritti. Interasse 192mm. Acciaio inox.
- Juego de tiradores. Distancia entre ejes 192mm. Acero.
- Pair of handles. Centre distance 192mm. Stainless steel.
- Paar gerade Stangegriffe. Achsenabstand 192mm. Edelstahl.
- Poignée double droite. Entraxe 192mm. Inox.

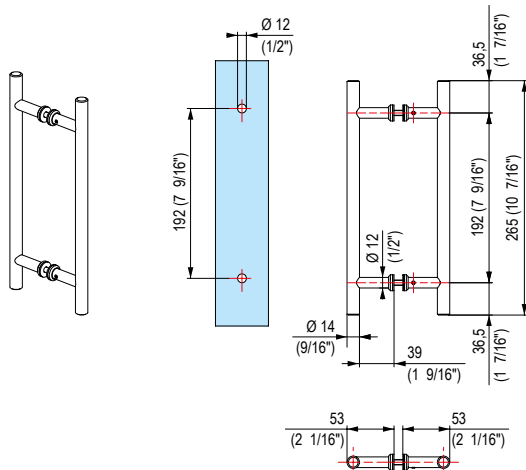

5H03



- Coppia maniglioni dritti. Interasse 250mm. Acciaio inox.
- Juego de tiradores. Distancia entre ejes 250mm. Acero.
- Pair of handles. Centre distance 250mm. Stainless steel.
- Paar gerade Stangegriffe. Achsenabstand 250mm. Edelstahl.
- Poignée double droite. Entraxe 250mm. Inox.

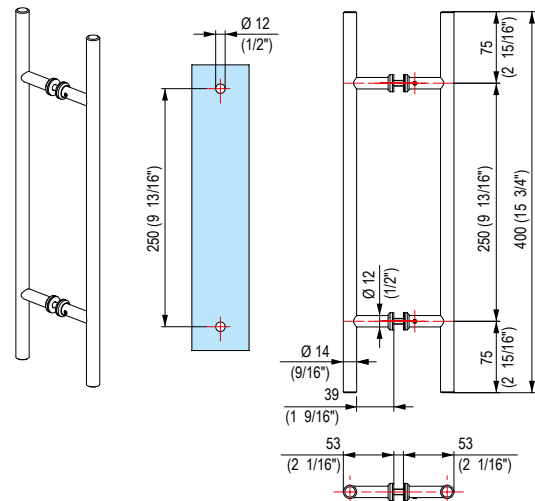

barre fermavetro / stabilising bars

Alluminio / Aluminium



5F01

finiture / colors
13-14-15-60-62

Alluminio / Aluminium



5F01A

finiture / colors
13-14-15-60-62

Alluminio / Aluminium



5F01T

finiture / colors
13-14-15-60-62

Alluminio / Aluminium



5F04

finiture / colors
13-14-15-60-62

Alluminio / Aluminium



5F20

finiture / colors
13-14-60-62

Alluminio / Aluminium



5F22

finiture / colors
13-14 -60-62

Alluminio / Aluminium



5F08

finiture / colors
13-14-15-16-17-60-62

Alluminio / Aluminium



5F10

finiture / colors
13-14-15-16-17-60-62



5F01



- Barra fermavetro muro-velro fisso.
- Barra refuerzo pared-vidrio fijo.
- Stabilising bar wall-fixed glass.
- Stabilisierungsstange Wand- festes Glas.
- Barre de renfort mur-verre fixe.

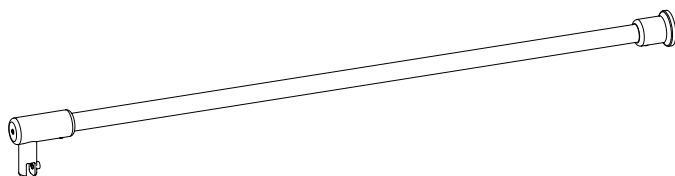
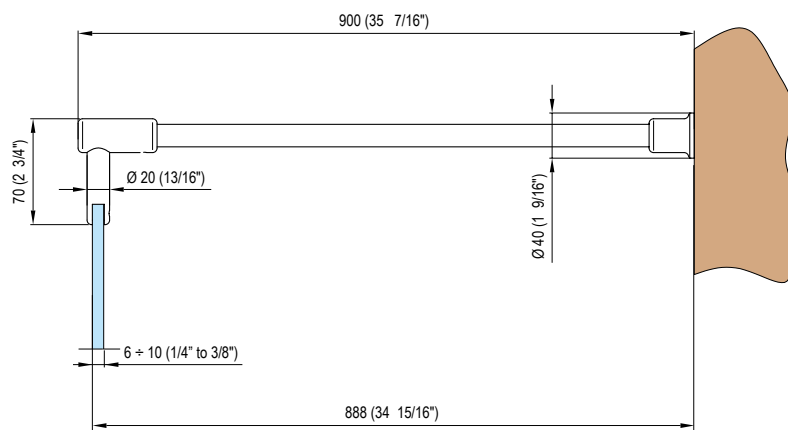

5F01A

- Barra fermavetro muro-velro fisso.
- Barra refuerzo pared-vidrio fijo.
- Stabilising bar wall-fixed glass.
- Stabilisierungsstange Wand- festes Glas.
- Barre de renfort mur-verre fixe.

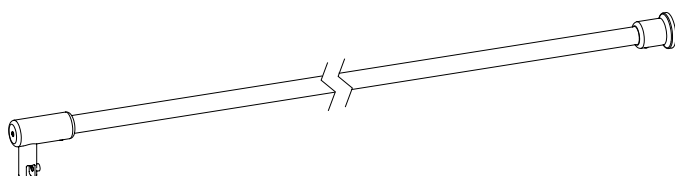
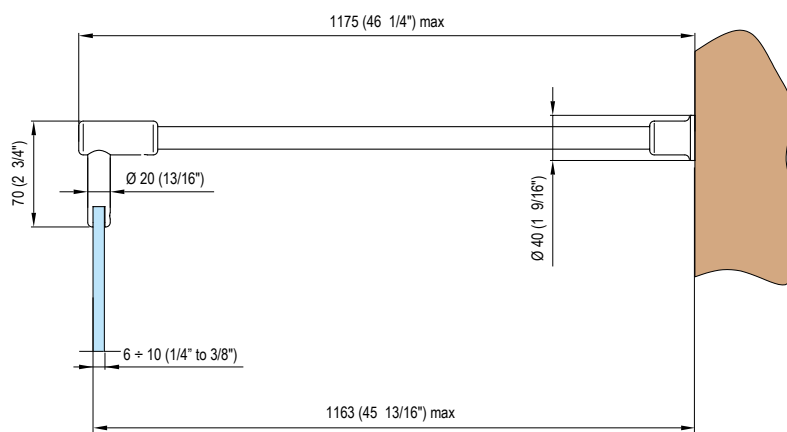

5F04



- Barra fermavetro vetro-vetro per due fissi.
- Barra refuerzo vidrio-vidrio para dos vidrios fijos.
- Stabilising bar for 2 fixed glasses.
- Stabilisierungsstange für zwei festen Glasplatten.
- Barre de renfort verre-verre pour deux verres fixes.

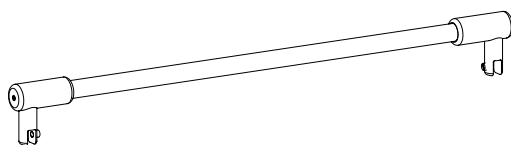
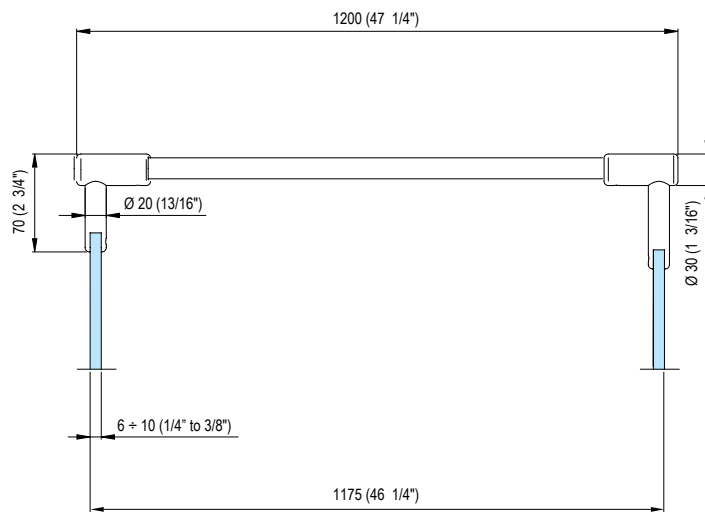

5F01T



- Accessorio a "T" per fermavetro.
- Accesorio a "T" para barra refuerzo.
- "T" accessory for stabilising bar.
- Zubehörteil für Stabilisierungsstange.
- Accessoire en "T" pour vitrage.

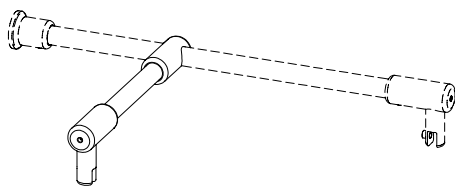
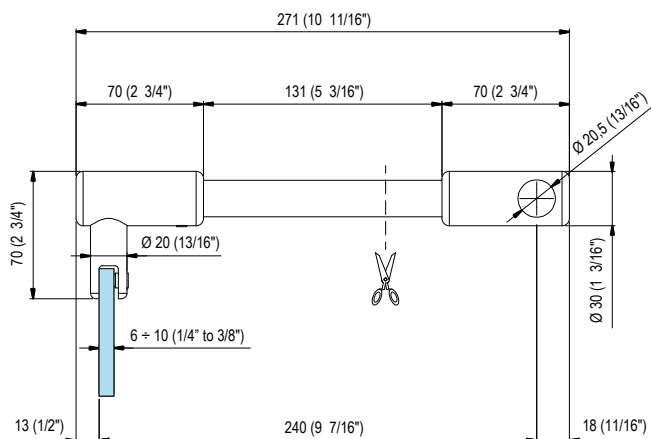

5F20

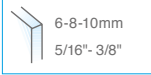

- Barra fermavetro muro-velro fisso. Sezione quadra.
- Barra refuerzo pared-vidrio fijo. Sección cuadrada.
- Stabilising bar wall-fixed glass. Square section.
- Stabilisierungsstange Wand- festes Glas. Rohr eckig.
- Barre de renfort mur-verre fixe. Section carrée.

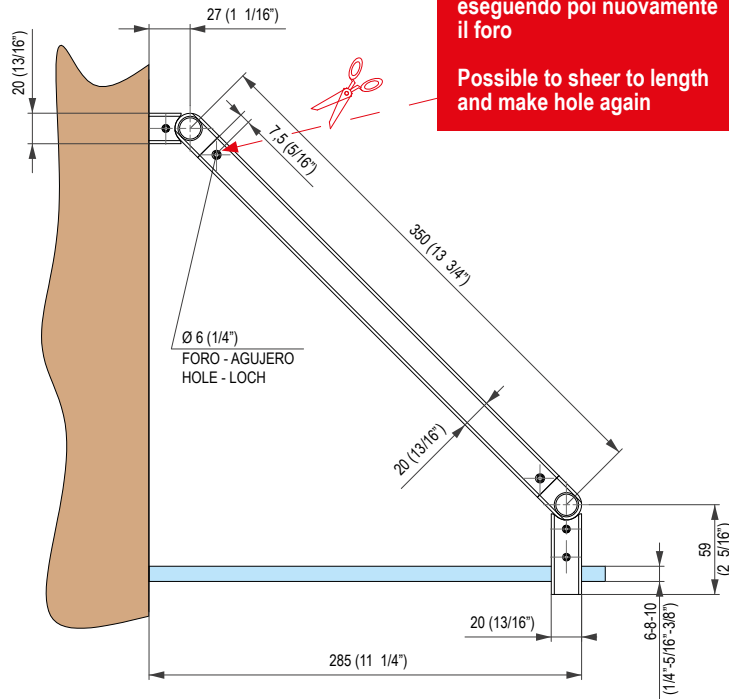
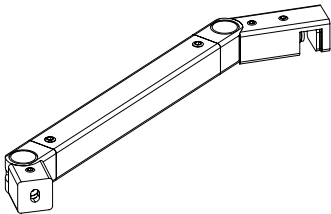

Possibile tagliare a misura eseguendo poi nuovamente il foro

Possible to shear to length and make hole again

5F22

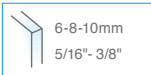

- Barra fermavetro muro-velro fisso. Sezione quadra.
- Barra refuerzo pared-vidrio fijo. Sección cuadrada.
- Stabilising bar wall-fixed glass. Square section.
- Stabilisierungsstange Wand- festes Glas. Rohr eckig.
- Barre de renfort murverre fixe. Section carrée.

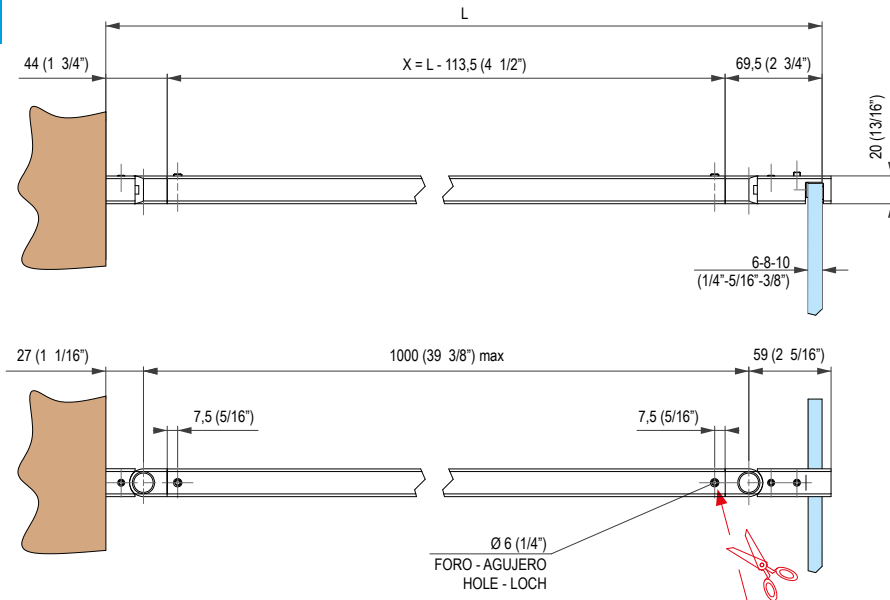
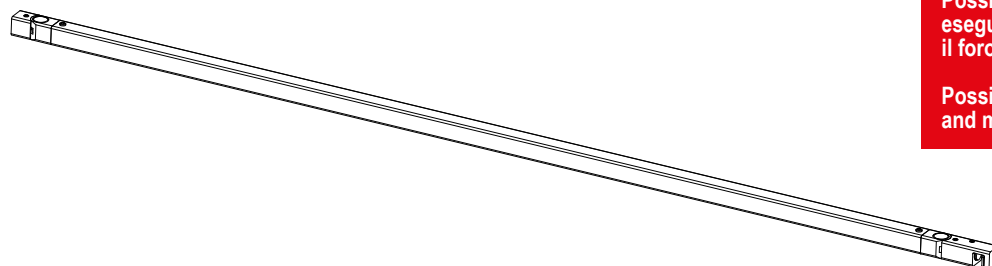

Possibile tagliare a misura eseguendo poi nuovamente il foro

Possible to shear to length and make hole again

5F08



- Barra fermavetro 45° muro-vidrio fijo.
- Barra refuerzo pared-vidrio fijo 45°.
- Stabilising bar 45°. Wall-fixed glass.
- Stabilisierungsstange bei 45°. Wand-festes Glas.
- Barre de renfort 45° mur-verre fixe.

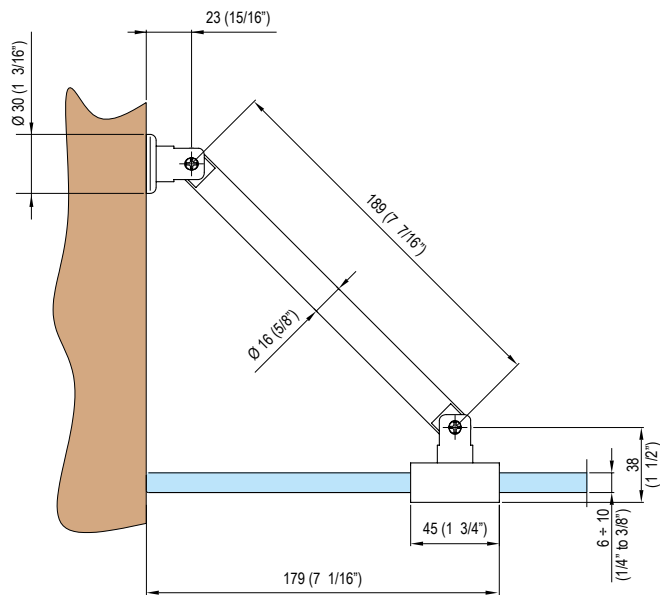
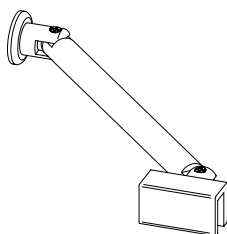

5F10



- Barra fermavetro 45° muro-vidrio fijo lungo.
- Barra refuerzo larga pared-vidrio fijo 45°.
- Stabilising bar 45°. Wall-fixed glass.
- Stabilisierungsstange bei 45°. Wand-festes Glas.
- Barre de renfort longue 45° mur-verre fixe.

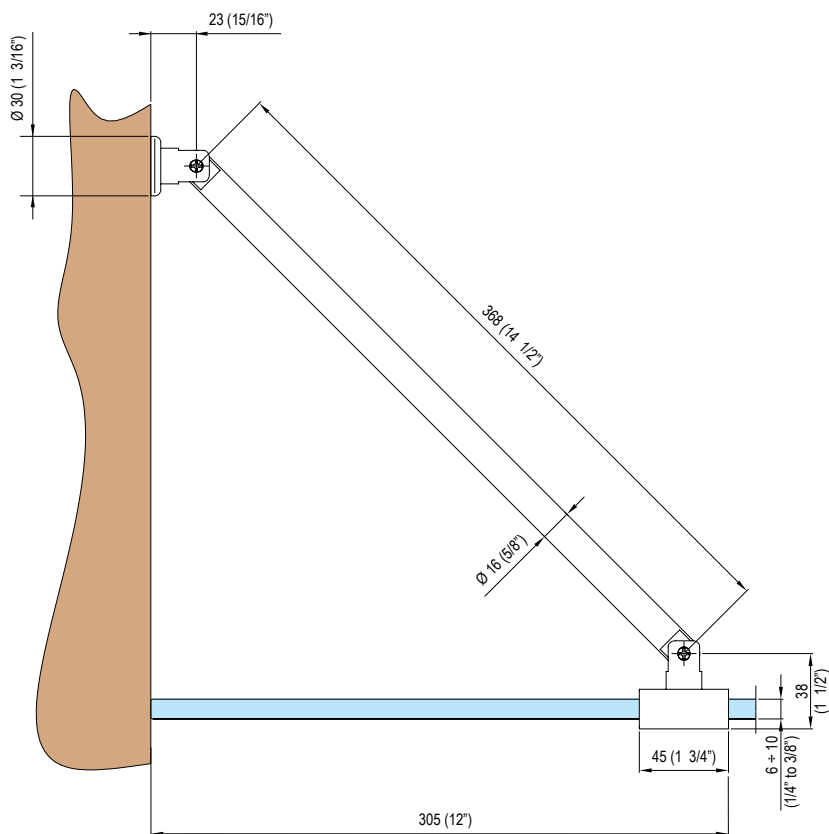
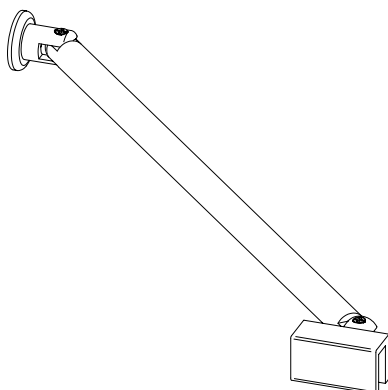

canalina fermavetro ad U e guarnizioni / U-shaped profil and gaskets

Acciaio Inox / Stainless Steel

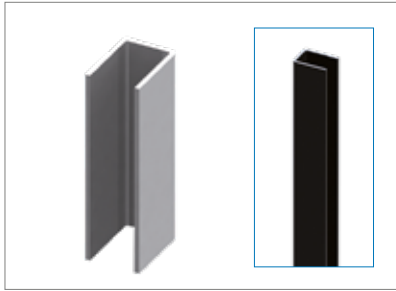

8P06 - 8P08 - 8P10

finiture / colors
31-32-62

Canaline fermavetro ad U in acciaio inox per il fissaggio a muro di vetri fissi frontali o laterali di spessore 6-8-10mm; e ampia gamma di guarnizioni: a palloncino, deviatore, battuta e magnetici.

Perfil en forma de U, hecho en acero inoxidable, que permite fijar vidrios fijos de 6, 8 o 10 mm (tanto frontales como laterales), nuestra gama de guarniciones: a globo, con tope, desviadoras y magnéticas.

Stainless steel U-shaped profiles, which allow the fastening of fixed panels (both side and front) of width 6-8-10 mm and a wide range of

gaskets: balloon, with stop, diverting and magnetic ones.

Die U-Profilen aus Edelstahl, um 6, 8 oder 10 mm Glas zu befestigen (beide Stir- und Seitengläse), sind verfügbar, zusammen mit eine große Auswahl von Dichtungen: Streif-, Anschlag-, Eckanschlag- und Magnetischdichtungen.

Profils en U en acier inoxydable pour la fixation de panneaux en verre fixes (à la fois sur le côté et la face avant) d'une épaisseur de 6-8-10 mm; et un large choix de joints.

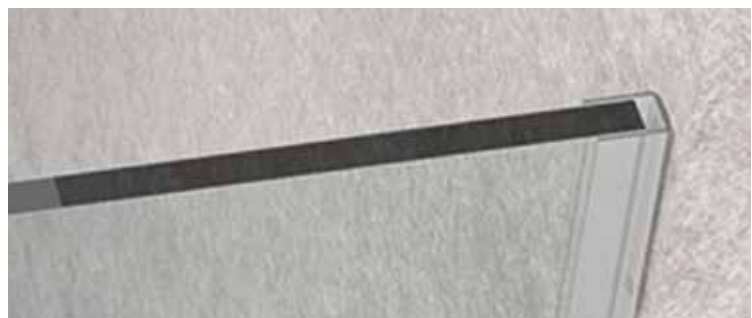

8PT8-10
2500mm

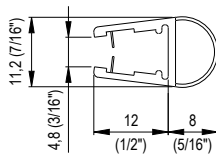
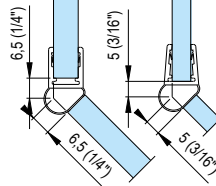
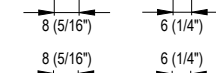
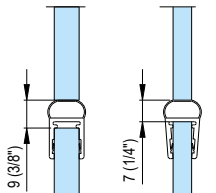
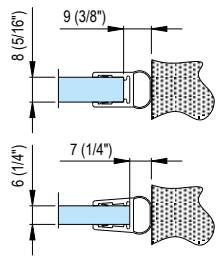

8PT1-10
2500mm

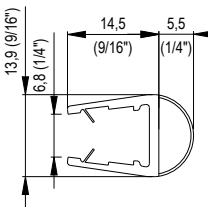
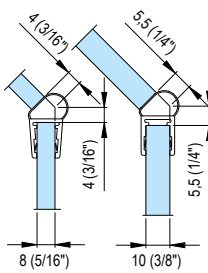
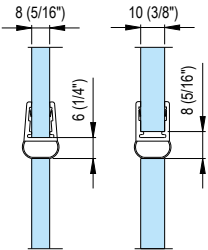
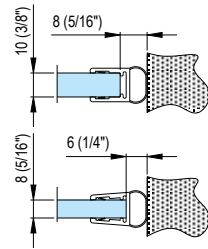

8PT8-20
2500mm

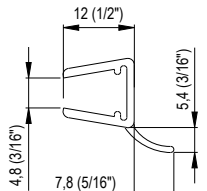
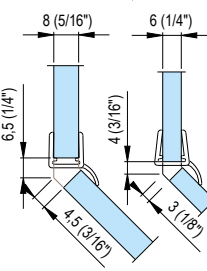
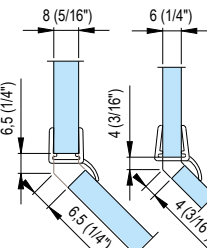
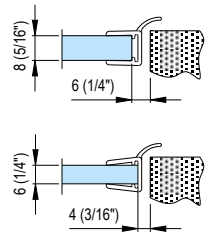
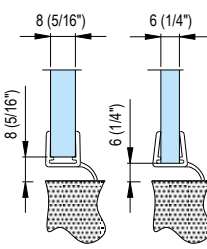

8PT1-20
2500mm

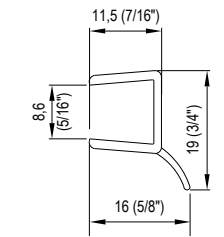
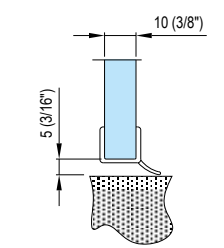
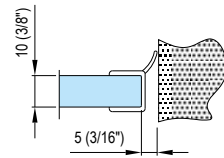

8PT8-25
2500mm

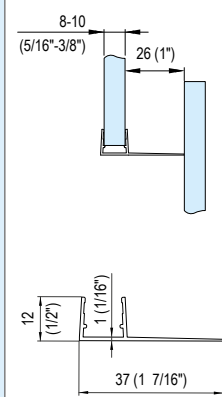

8PT8-26
2500mm

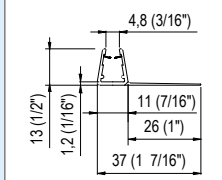
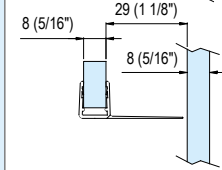
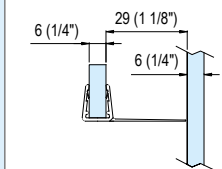

8PT8-30
2500mm

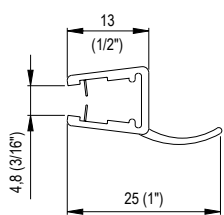
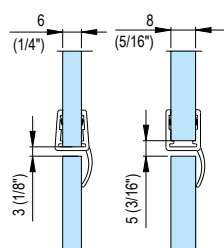
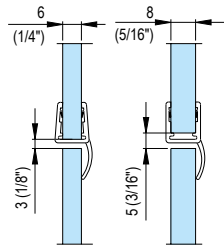
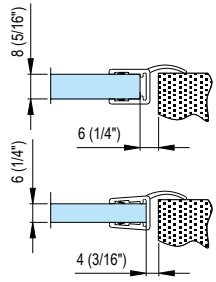

8PT1-30
2500mm

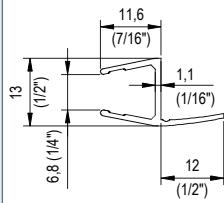
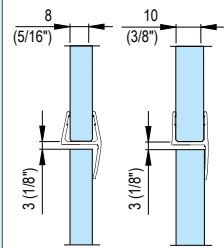

8PT1-33
2500mm

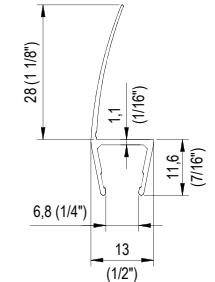
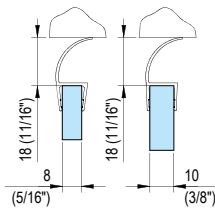

8PT8-35
2500mm

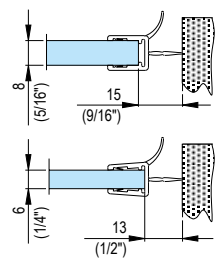

8PT8-35C
R=540mm
L=490mm

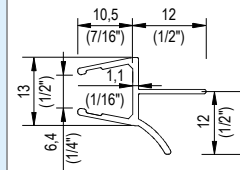
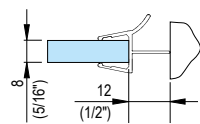

8PT1-35
2500mm

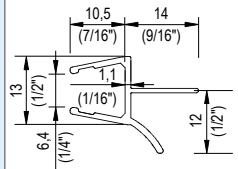
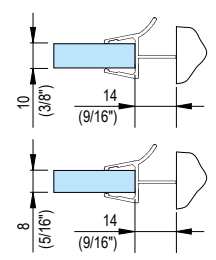

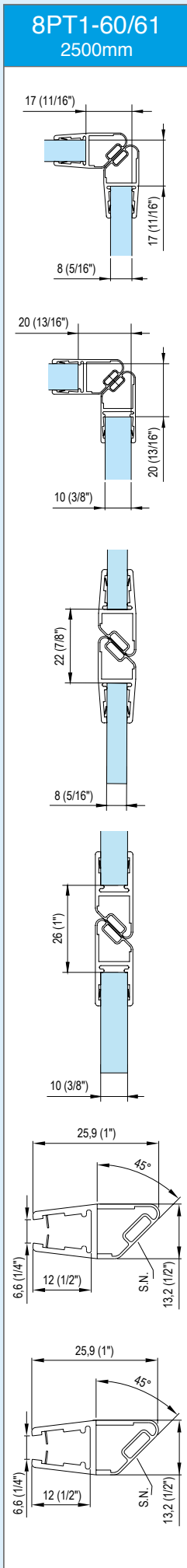
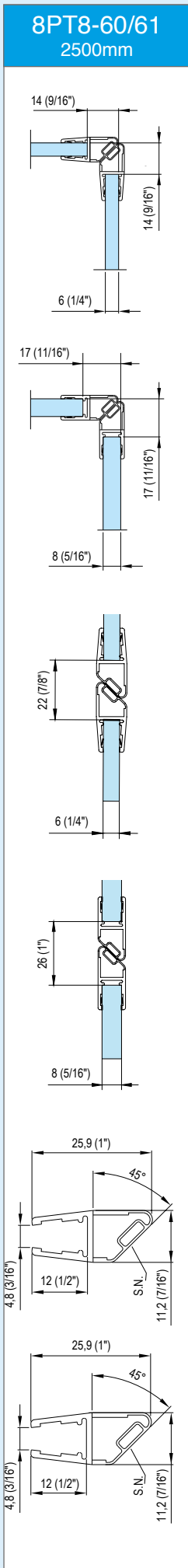
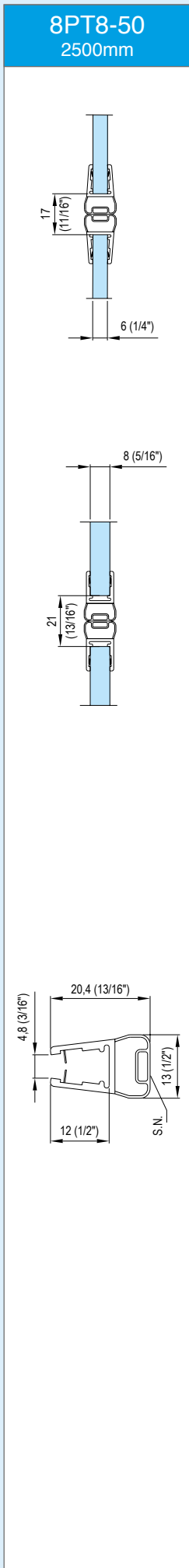
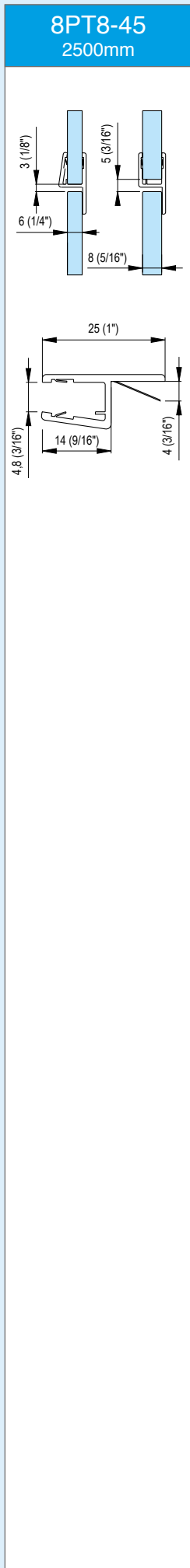
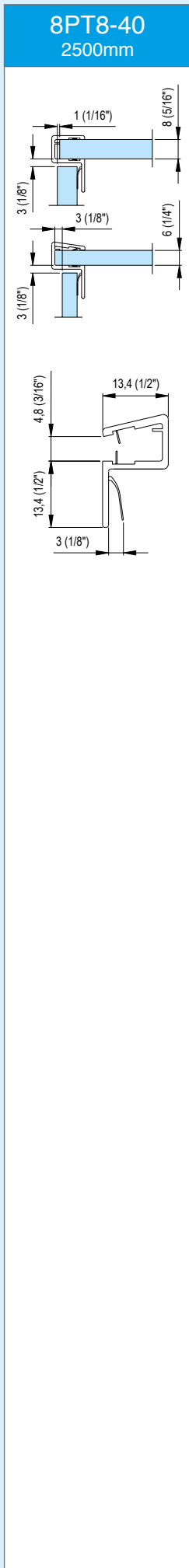

8PT8-70/71
2500mm

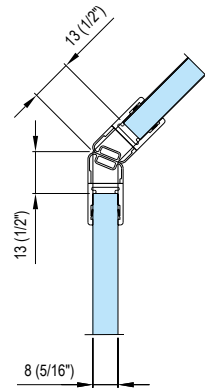
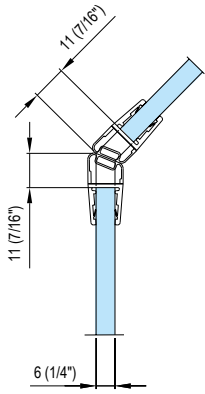

135°

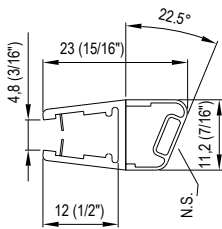
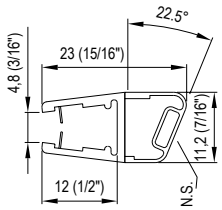

8PI1-32
2200mm

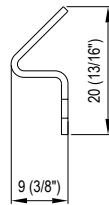
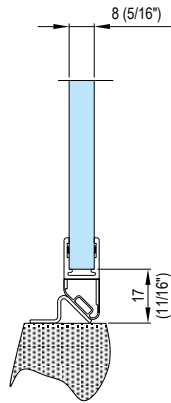
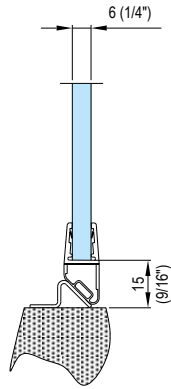

8P06
2500mm

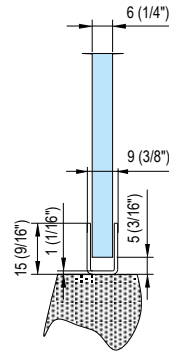

8P08
2500mm

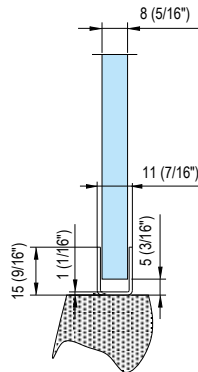

8P10
2500mm

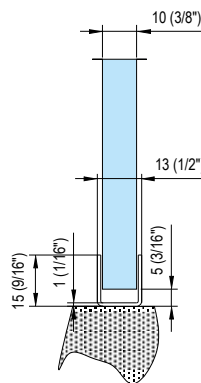

8PT6-37
2500mm

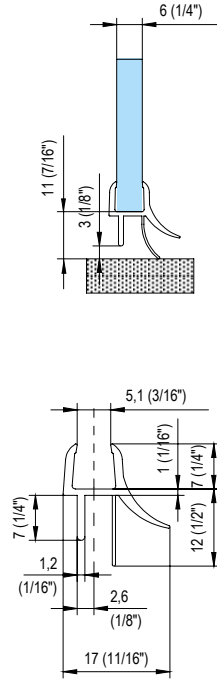

8PT8-37
2500mm

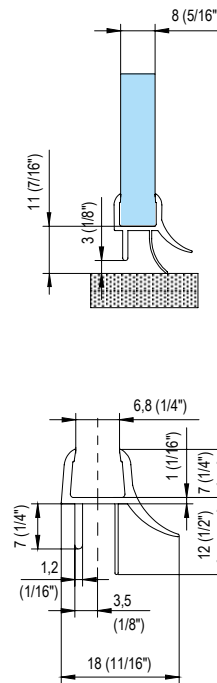

TC10

- Tappo copri vite.
- Tapa cobre tornillo.
- Screw cover.
- Schraubdeckel.
- Cache vis.

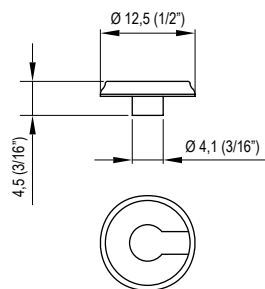

SP8500

- Spessore di regolazione per 8500.
- Cuña de regulación para art. 8500.
- Adjustment shim for 8500.
- Abstandsscheibe für 8500.
- Cale de réglage pour art.8500.

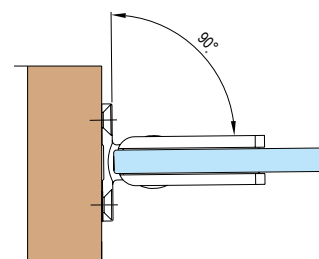
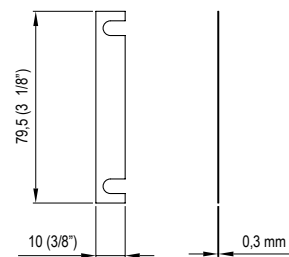

VT10

- Vite inox 4,5 x 50mm.
- Tornillo inoxidable 4,5 x 50mm.
- Stainless steel screw 4,5 x 50mm.
- Schraube aus Edelstahl 4,5 x 50mm.
- Vis inox 4,5 x 50mm.

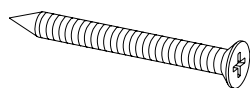
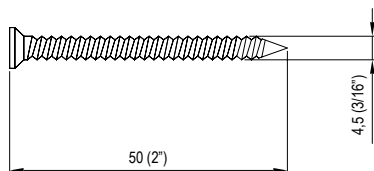



PORTE INTERNE

Puertas Internas
Inner Doors
Innentüren
Portes Intérieures

cerniere oleodinamiche / oildynamic hinges

Biloba EVO



835E10N



835E50



Alluminio / Aluminium - finiture / colors 02-05-13-14-15-16-17-22

Prodigiosa e rivoluzionaria: è la cerniera con chiudiporta integrato per porte in battuta interne ed esterne. La prima cerniera con chiusura regolabile e controllo costante di frenatura, per tutte le angolazioni di apertura della porta fino a 180°. Disponibile anche nella versione con automatismo di chiusura da 90° a 0°. Controllo costante di frenatura. Cerniera libera da 90° a 180°. Fornita di un ammortizzatore anti-scardinamento e dotata di un dispositivo di sovrappressione che evita rotture in caso di stratonamento accidentale. Si installa a muro o legno e su stipiti con profilo in battuta.

Prodigiosa y revolucionaria: la bisagra con cierra puerta "integrado" para puerta interior y exterior – con tope. La primera bisagra con cierre ajustable y control constante de frenado, para todos los ángulos de apertura de la puerta hasta 180°. Disponible también con cierre automático, desde 90° a 0°. Control constante de frenado. Bisagra "libre" desde 90° a 180°. Provista de un amortiguador anti-desquiciamiento y equipada con un dispositivo de superpresión que evita la rotura en caso de empujones accidentales. Se instala a pared, a madera o con puertas con perfil y tope. Profundidad estípite entre 30 y 50 mm.

Prodigious and revolutionary: hinge with integrated door closer for doors with stop both internal and external. The first hinge with adjustable closing and constant braking control, for all door opening angles up to 180°. Also available in the version with automatic closing from 90° to 0°. Free hinge from 90° to 180°. It prevents unhinging through a shock

absorber and has an over-pressure device that avoids breaking in accidental shoving scenarios. May be fixed to wall, wood or profiles with a stop. Jamb depth from 30 to 50 mm.

Erstaunlich und revolutionär: das Band mit integriertem Türschließer für Anschlagtüren im Innen- und Außenbereich. Das erste Hydraulikband mit einer regulierbaren Schließgeschwindigkeit und konstanter Kontrolle der Bremsung, für alle Öffnungswinkel der Tür bis 180°. Ebenfalls in der Automatik Version verfügbar von 90° bis 0°. Mit konstanter Bremskontrolle. Freilauf des Bandes vom 90° bis 180°. Das Band ist mit einer Dämpfung ausgestattet, die eine Aushebelung der Tür verhindert, sowie einen etwaigen Überdruck reguliert und somit Bruch durch eventuelle plötzliche Stöße kompensiert. Man kann es an der Wand, Holz oder auf Türen mit Rahmen installieren. Tiefe des Türpfosten von 30 bis 50 mm.

Prodigieuse et révolutionnaire, la charnière Biloba Evo possède un système de fermeture intégré pour portes à butée. C'est la première charnière avec réglage et contrôle de la vitesse de fermeture, pour tout type d'angle jusqu'à 180°. Disponible également dans la version avec fermeture automatique de 90° à 0°, avec contrôle constant de la fermeture. Charnière libre de 90° à 180°. Elle est munie d'un amortisseur anti-dégondage et équipée d'un dispositif de surpression qui permet d'éviter la rupture en cas de choc accidentel. Elle peut être installée sur mur, bois ou profils avec stop. Profondeur du jambage de 30 à 50 mm.





835E10N

Biloba Evo oleodynamic hinge

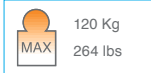
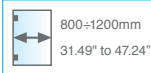
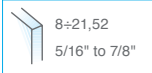

• Cerniera oleodinamica vetro-muro per porte in battuta, con velocità di chiusura regolabile e controllo costante di frenatura; permette un'apertura della porta fino a 180°. Stop a +90° +180°. **Si installa su porte con profilo in battuta. Profondità stipite da 30 a 50 mm.**

• Bisagra automática hidráulica vidrio-pared para puerta con tope; regulación de velocidad de cierre de la puerta y control constante de frenado; la puerta se puede abrir hasta 180°. Stop a +90° +180°. **Se instala en puertas con perfil con batida. Profundidad estípite entre 30 y 50 mm.**

• Hydraulic hinge glass to wall for doors with stop, with adjustable closing speed and constant braking control; the door opens up to 180°. Stop at +90° +180°. **Installed on doors with a profile on a stop. Jamb depth from 30 to 50 mm.**

• Hydraulikband Glas-Wand für Anschlagtüren, mit regulierbar Schließgeschwindigkeit und konstanter Kontrolle der Bremsung; Öffnung der Tür bis 180°. Feststellung +90° +180°. **Man kann es auf Türen mit Rahmen benutzen. Pfostentiefe von 30 bis 50 mm.**

• Charnière hydraulique verre-mur pour porte à butée avec contrôle constant de la vitesse de fermeture. fermeture, ce qui permet une ouverture de la porte jusqu'à 180°. Arrêt à +90° et +180°. **S'installe sur profil de porte. Profondeur du jambage de 30 à 50 mm.**

835E10N R = destra - derecha - right - rechts - droite
835E10N L = sinistra - izquierda - left - links - gauche

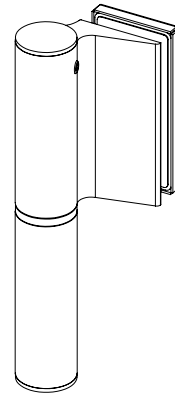

835E10NL

* • È necessaria una battuta in chiusura in quanto la cerniera ha una precarica. • Necesita de un cierre con tope, puesto que la bisagra tiene una precarga. • The hinge has a loading and it is therefore necessary a closing stop. • Eine Schließfeststellung ist notwendig, weil das Scharnier eine mechanische Belastung hat. • La charnière a une charge, il est donc nécessaire d'avoir un arrêt de fermeture.

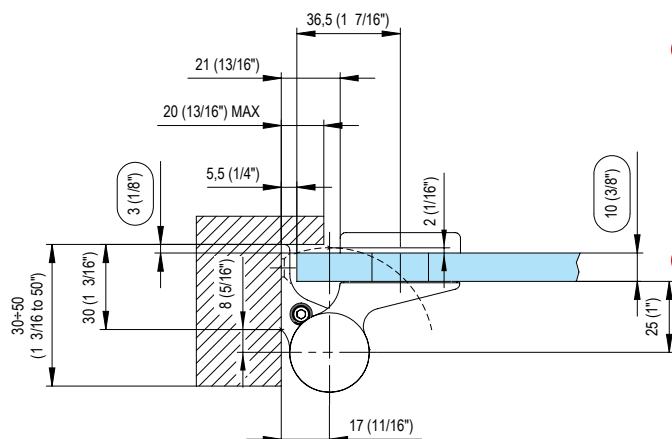
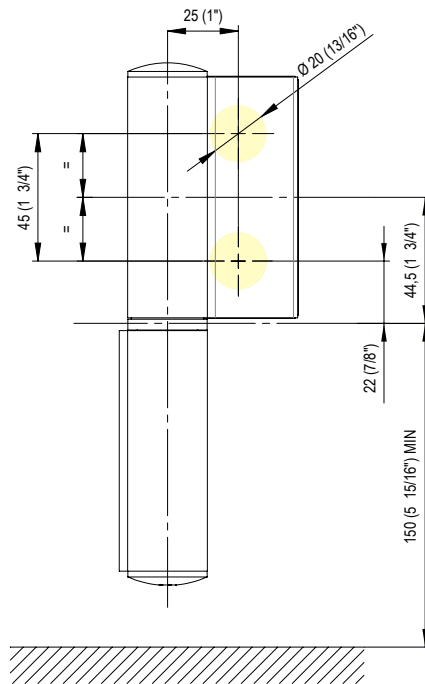
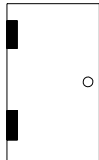

Classificazione secondo normativa - Clasificación según la ley - Classification according to int'l regulation - Klassifizierung nach den Vorschriften - Classification selon la norme					
art. 835E10N	UNI EN 1154 : 2006	3	8	3/6	0 1 5

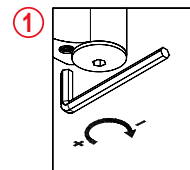
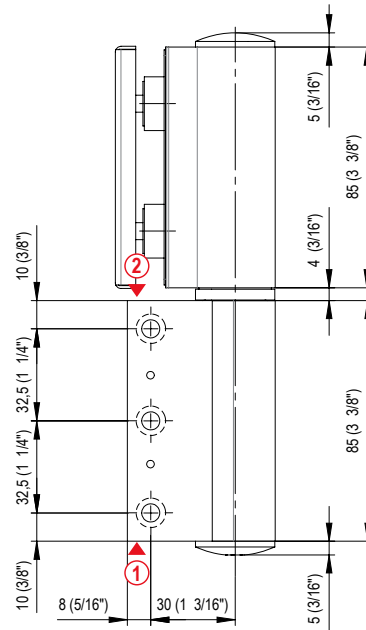

Regolazione scatto finale
 Ajuste del resorte final
 Final latch adjustment
 Regulierung der Endschwingung
 Réglage de verouillage final

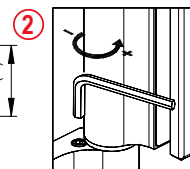

Regolazione della velocità di chiusura
 Ajuste de la velocidad de cierre
 Closing speed adjustment
 Regulierung der Schließgeschwindigkeit
 Réglage de la vitesse de fermeture

835E11N

Biloba Evo oleodynamic hinge

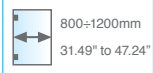
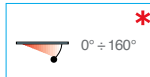

• Cerniera oleodinamica vetro-muro per porte in battuta, con velocità di chiusura regolabile e controllo costante di frenatura; permette un'apertura della porta fino a 180°. Stop a +180°. **Si installa su porte con profilo in battuta. Profondità stipite da 30 a 50 mm.**

• Bisagra automática hidráulica vidrio-pared para puerta con tope; regulación de velocidad de cierre de la puerta y control constante de frenado; la puerta se puede abrir hasta 180°. Stop a +180°. **Se instala en puertas con perfil con batida. Profundidad estípite entre 30 y 50 mm.**

• Hydraulic hinge glass to wall for doors with stop, with adjustable closing speed and constant braking control; the door opens up to 180°. Stop at +180°. **Installed on doors with a profile on a stop. Jamb depth from 30 to 50 mm.**

• Hydraulikband Glas-Wand für Anschlagtüren, mit regulierbar Schließgeschwindigkeit und konstanter Kontrolle der Bremsung; Öffnung der Tür bis 180°. Feststellung +180°. **Man kann es auf Türen mit Rahmen benutzen. Pfostentiefe von 30 bis 50 mm.**

• Charnière hydraulique verre-mur pour porte à butée, avec contrôle de la vitesse de fermeture. Elle permet une ouverture de la porte jusqu'à 180°. Arrêt à 180°. **S'installe sur porte à butée avec profil. Profondeur de jambage 30 à 50 mm.**

835E11N R = destra - derecha - right - rechts - droite
835E11N L = sinistra - izquierda - left - links - gauche

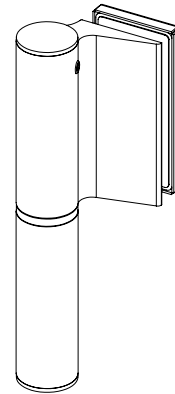

835E11NL

*

• È necessaria una battuta in chiusura in quanto la cerniera ha una precarica. • Necesita de un cierre con tope, puesto que la bisagra tiene una precarga. • The hinge has a loading and it is therefore necessary a closing stop. • Eine Schließfeststellung ist notwendig, weil das Scharnier eine mechanische Belastung hat. • La charnière a une charge, il est donc nécessaire d'avoir un arrêt de fermeture.

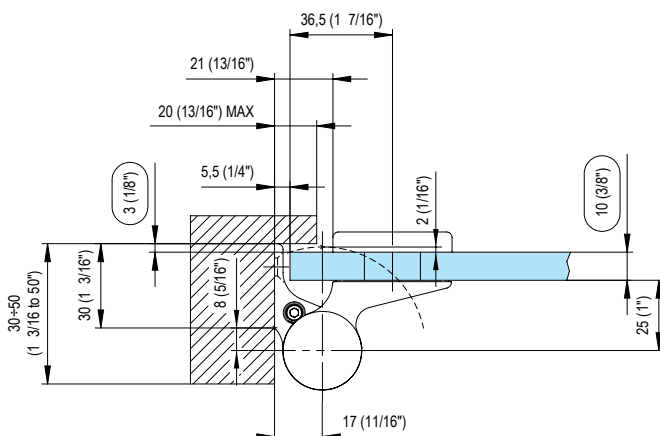
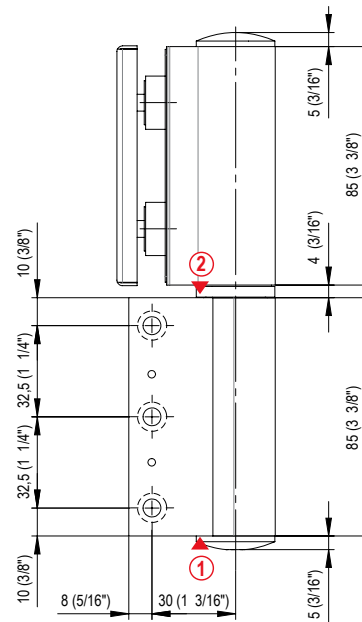
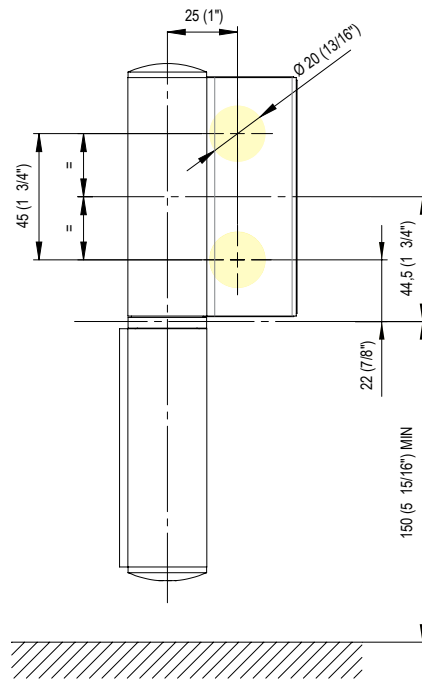
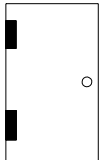

Classificazione secondo normativa - Clasificación según la ley - Classification according to int'l regulation - Klassifizierung nach den Vorschriften - Classification selon la norme

art. 835E11N	UNI EN 1154 : 2006	3	8	3/6	0	1	5
--------------	--------------------	---	---	-----	---	---	---

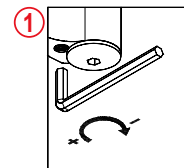

Regolazione scatto finale
Ajuste del resorte final
Final latch adjustment
Regulierung der Endschwung
Réglage de verrouillage final

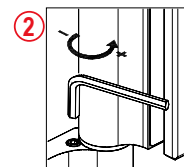

Regolazione della velocità di chiusura
Ajuste de la velocidad de cierre
Closing speed adjustment
Regulierung der Schließgeschwindigkeit
Réglage de la vitesse de fermeture

835E50

Biloba Evo oildynamic hinge

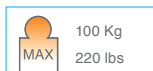
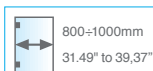
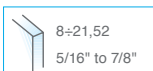

• Cerniera oleodinamica vetro-vetro per porte in battuta, con velocità di chiusura regolabile e controllo costante di frenatura; permette un'apertura della porta fino a 180°. Stop a +90° +180°. **Si installa su porte con profilo in battuta. Profondità stipite da 30 a 50 mm.**

• Bisagra automática hidráulica vidrio-vidrio para puerta con tope; regulación de velocidad de cierre de la puerta y control constante de frenado; la puerta se puede abrir hasta 180°. Stop a +90°, +180°. **Se instala en puertas con perfil con batida. Profundidad estipite entre 30 y 50 mm.**

• Hydraulic hinge glass to glass for doors with stop, with adjustable closing speed and constant braking control; the door opens up to 180°. Stop at +90° +180°. **Installed on doors with a profile on a stop. Jamb depth from 30 to 50 mm.**

• Hydraulikband Glas-Glas für Anschlagtüren, mit regulierbar Schließgeschwindigkeit und konstanter Kontrolle der Bremsung; Öffnung der Tür bis 180°. Feststellung +90° +180°. **Man kann es auf Türen mit Rahmen benutzen. Pfostentiefe von 30 bis 50 mm.**

• Charnière hydraulique verre-mur pour porte en butée, avec vitesse de fermeture réglable et contrôle constant du freinage; permet une ouverture de la porte à 180°. Arrêt à +90° et +180°. **S'installe sur profil de porte. Profondeur de jambage de 30 à 50 mm.**

835E50 R = destra - derecha - right - rechts - droite
835E50 L = sinistra - izquierda - left - links - gauche

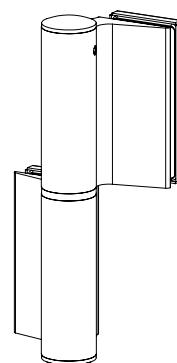

835E50L

*

• È necessaria una battuta in chiusura in quanto la cerniera ha una pre-carica. • Necesita de un cierre con tope, puesto que la bisagra tiene una precarga. • The hinge has a loading and it is therefore necessary a closing stop. • Eine Schließfeststellung ist notwendig, weil das Scharnier eine mechanische Belastung hat. • La charnière a une charge, il est donc nécessaire d'avoir un arrêt de fermeture.

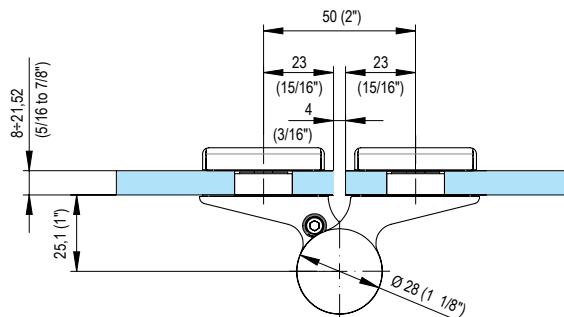
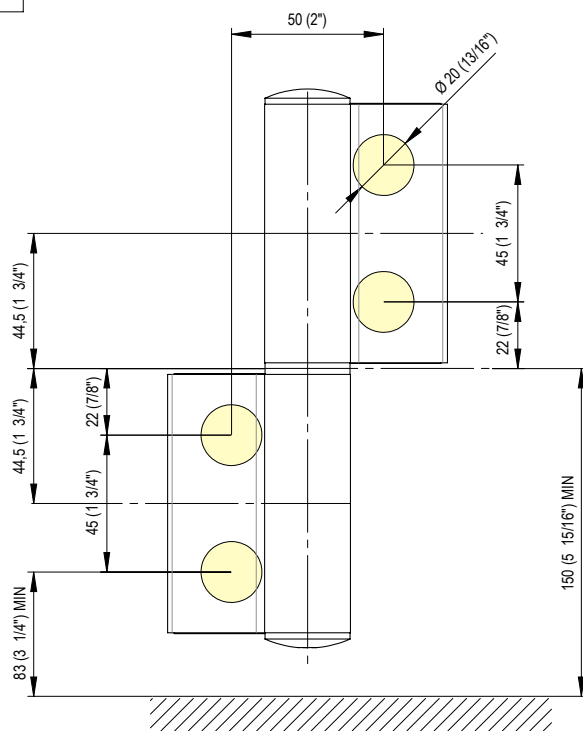
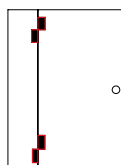

Classificazione secondo normativa - Clasificación según la ley - Classification according to int'l regulation - Klassifizierung nach den Vorschriften - Classification selon la norme



art. 835E50 UNI EN 1154 : 2006 3 8 3/8 0 1 5

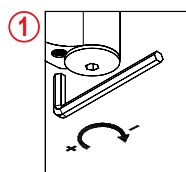
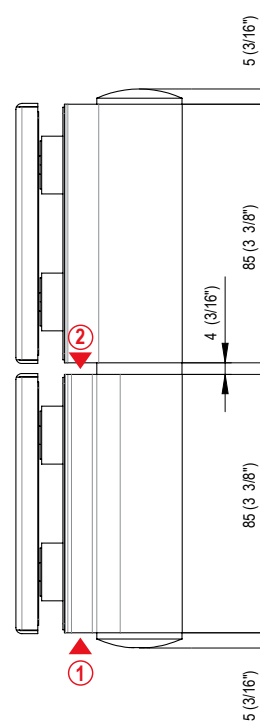

Regolazione scatto finale
 Ajuste del resorte final
 Final latch adjustment
 Regulierung der Endanschlag
 Réglage de verrouillage final

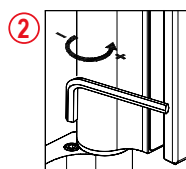

Regolazione della velocità di chiusura
 Ajuste de la velocidad de cierre
 Closing speed adjustment
 Regulierung der Schließgeschwindigkeit
 Réglage de la vitesse de fermeture

835E51

Biloba Evo oildynamic hinge

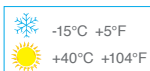
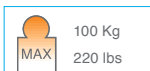
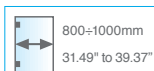
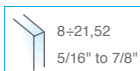

• Cerniera oleodinamica vetro-vetro per porte in battuta, con velocità di chiusura regolabile e controllo costante di frenatura; permette un'apertura della porta fino a 180°. Stop a +180°. **Si installa su porte con profilo in battuta. Profondità stipite da 30 a 50 mm.**

• Bisagra automática hidráulica vidrio-vidrio para puerta con tope; regulación de velocidad de cierre de la puerta y control constante de frenado; la puerta se puede abrir hasta 180°. Stop a +180°. **Se instala en puertas con perfil con batida. Profundidad estípite entre 30 y 50 mm.**

• Hydraulic hinge glass to glass for doors with stop, with adjustable closing speed and constant braking control; the door opens up to 180°. Stop at +180°. **Installed on doors with a profile on a stop. Jamb depth from 30 to 50 mm.**

• Hydraulikband Glas-Glas für Anschlagtüren, mit regulierbar Schließgeschwindigkeit und konstanter Kontrolle der Bremsung; Öffnung der Tür bis 180°. Feststellung +180°. **Man kann es auf Türen mit Rahmen benutzen. Pfostentiefe von 30 bis 50 mm.**

• Charnière hydraulique verre-mur pour porte en butée, avec vitesse de fermeture réglable et contrôle constant du freinage; permet une ouverture de la porte à 180°. Arrêt à +180°. **S'installe sur profil de porte. Profondeur de jambage de 30 à 50 mm.**

835E51 R = destra - derecha - right - rechts - droite
835E51 L = sinistra - izquierda - left - links - gauche

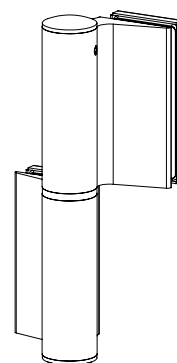

835E51L

*

• È necessaria una battuta in chiusura in quanto la cerniera ha una precarica. • Necesita de un cierre con tope, puesto que la bisagra tiene una precarga. • The hinge has a loading and it is therefore necessary a closing stop. • Eine Schließfeststellung ist notwendig, weil das Scharnier eine mechanische Belastung hat. • La charnière a une charge, il est donc nécessaire d'avoir un arrêt de fermeture.

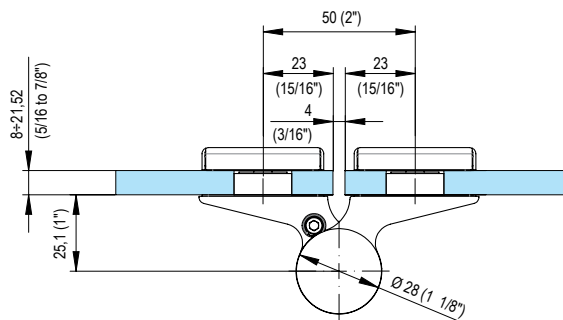
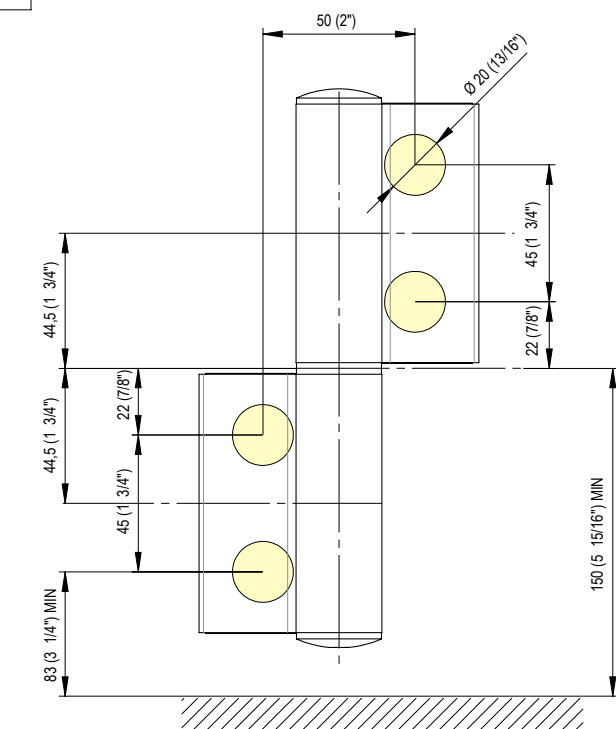
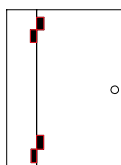

Classificazione secondo normativa - Clasificación según la ley - Classification according to int'l regulation - Klassifizierung nach den Vorschriften - Classification selon la norme							
art. 835E51	UNI EN 1154	: 2006	3	8	3/6	0 1 5	

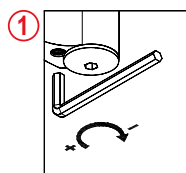
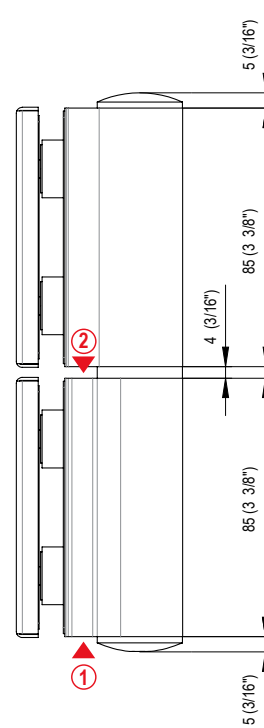

Regolazione scatto finale
Ajuste del resorte final
Final latch adjustment
Regulierung der Endanschlag
Réglage de verrouillage final

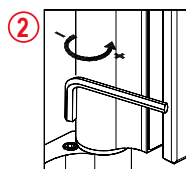

Regolazione della velocità di chiusura
Ajuste de la velocidad de cierre
Closing speed adjustment
Regulierung der Schließgeschwindigkeit
Réglage de la vitesse de fermeture

836E10

Biloba Evo

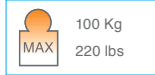
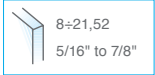

- Cerniera libera a terra per porte in battuta. Da abbinare con 835E10N-835E11N.
- Bisagra de suelo para puertas con tope. Para utilizar junto con 835E10N-835E11N.
- Free bottom pivot hinge for doors with stop. To be matched with 835E10N-835E11N.
- Freies Band als Bodenlager für Anschlagtüren. Zur Kombination mit 835E10N-835E11N.
- Charnière libre inférieure pour porte avec butée. A combiner avec les références 835E10N-835E11N.

836E10 R = destra - derecha - right - rechts - droite
836E10 L = sinistra - izquierda - left - links - gauche

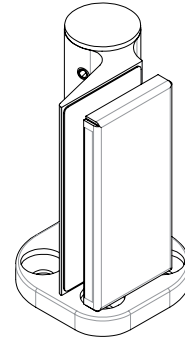

836E10L

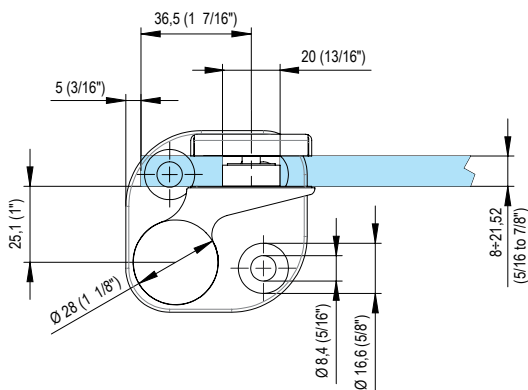
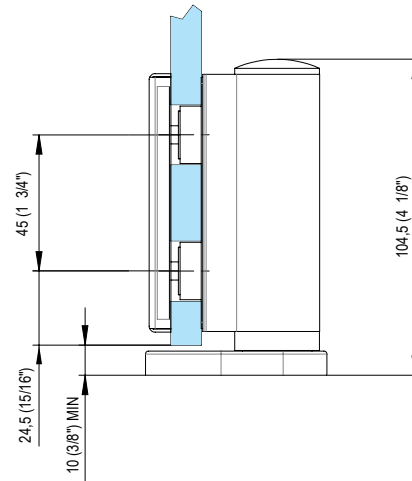
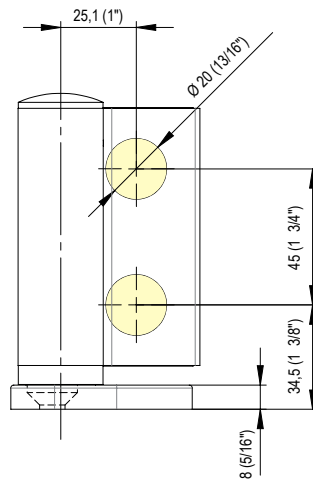
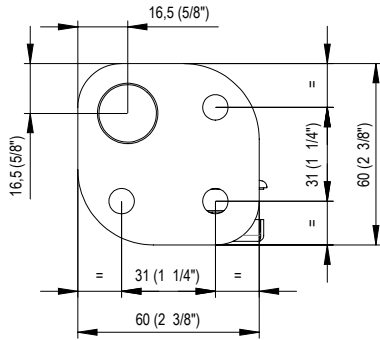

835E10-11

836E106

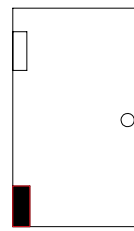

835E10N SOL Biloba Evo

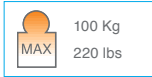
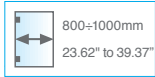
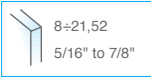

- Cerniera libera vetro-muro per porte in battuta. Da abbinare con 835E10N-835E11N. Si installa su porte con profilo in battuta. Profondità stipite da 30 a 50 mm.
- Bisagra libre pared-vidrio para puertas con tope. Para utilizar junto con 835E10N-835E11N. Se instala en puertas con perfil con batida. Profundidad estipite entre 30 y 50 mm.
- Free hinge wall-glass for doors with stop. To be matched with 835E10N-835E11N. Installed on doors with a profile on a stop. Jamb depth from 30 to 50 mm.
- Freies Band Glas-Wand für Anschlagtüren. Zur Kombination mit 835E10N-835E11N Man kann es auf Türen mit Rahmen benutzen. Pfostentiefe von 30 bis 50 mm.
- Charnière libre verre-mur pour porte à butée. A combiner avec les références 835E10N-835E11N. S'installe sur porte à butée avec profil. Profondeur de jamba-ge 30 à 50 mm.

835E10NSOL R = destra - derecha - right - rechts - droite
 835E10NSOL L = sinistra - izquierda - left - links - gauche

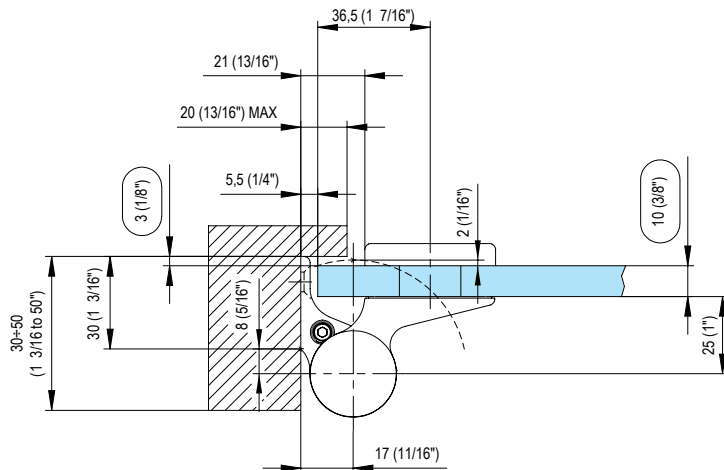
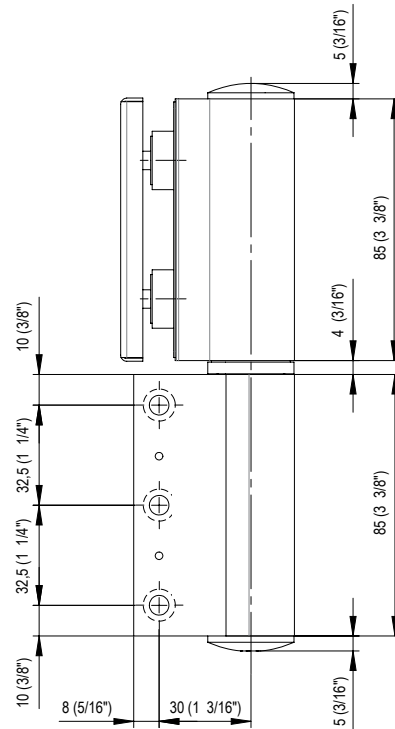
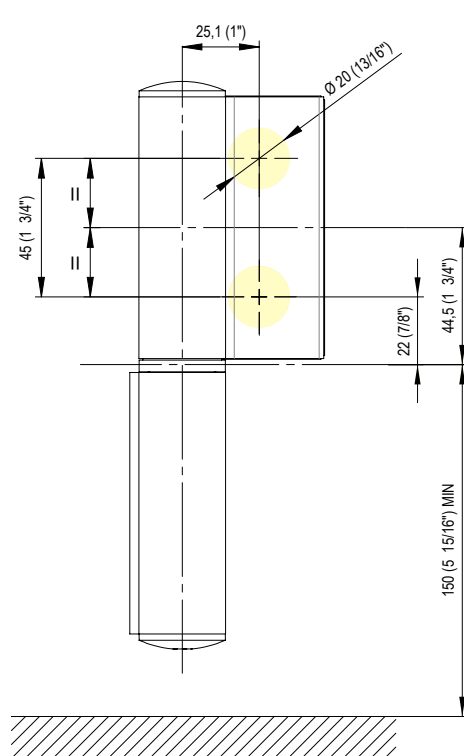
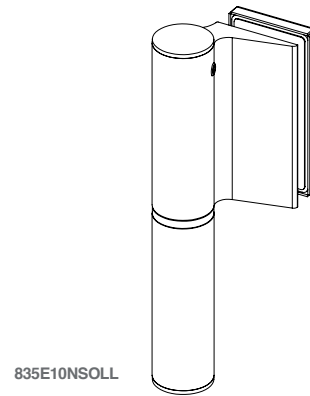

835E50SOL

Biloba Evo

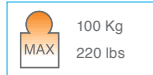
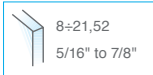

- Cerniera libera vetro-vetro per porte in battuta.
Da abbinare con 835E50-835E51.
- Bisagra libre vidrio-vidrio para puertas con tope.
Para utilizar junto con 835E50-835E51.
- Free hinge glass-glass for doors with stop.
To be matched with 835E50-835E51.
- Freies Band Glas-Glas für Anschlagtüren.
Zur Kombination mit 835E50-835E51.
- Charnière libre verre contre verre pour porte avec butée.
A combiner avec les références 835E50-835E51.

835E50 SOL R = destra - derecha - right - rechts - droite
835E50 SOL L = sinistra - izquierda - left - links - gauche

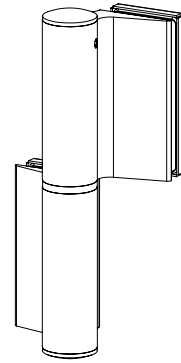

835E50SOLL

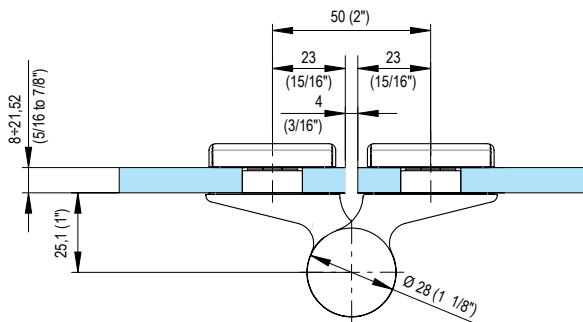
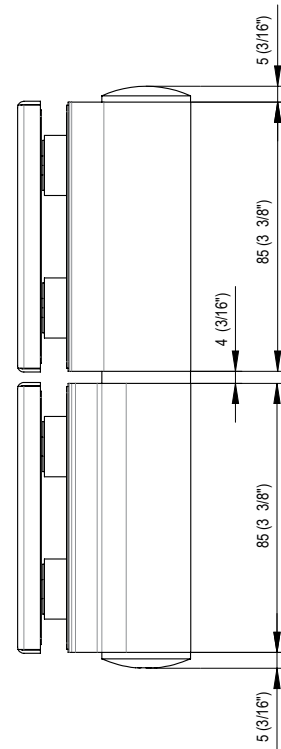
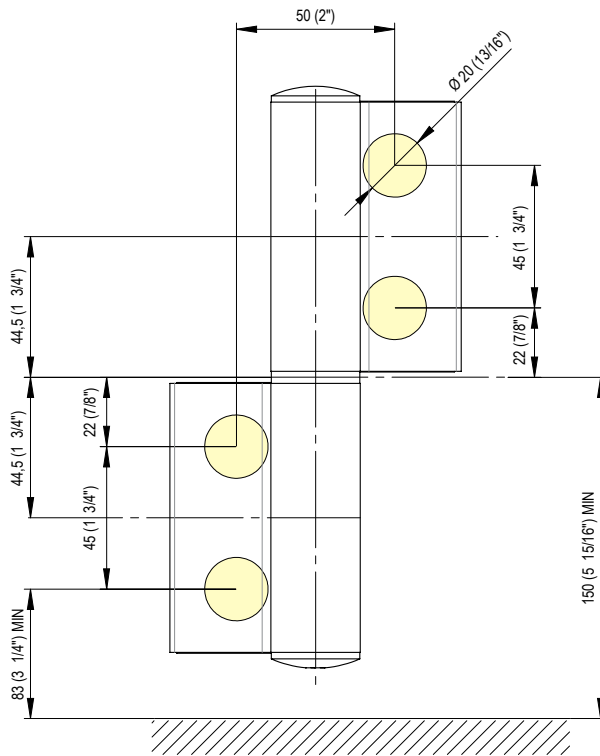

835E50SOL

835E50-51

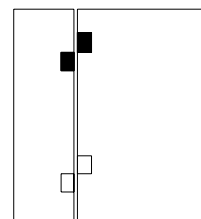

Riepilogo applicazioni disponibili con Biloba EVO. Chiusura automatica da 90° e 180° Biloba EVO applications summary. Automatic closing from 90° to 180°

SOLUZIONE - SOLUTION 1

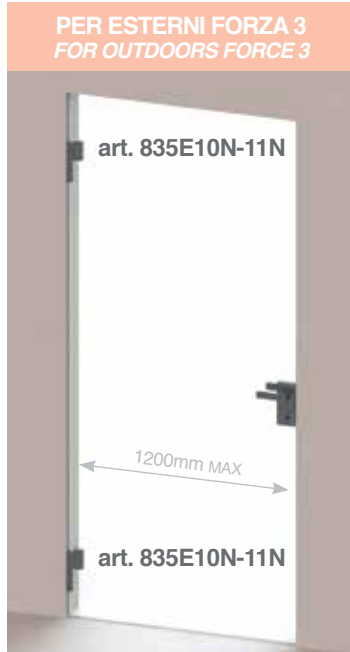

SOLUZIONE - SOLUTION 2

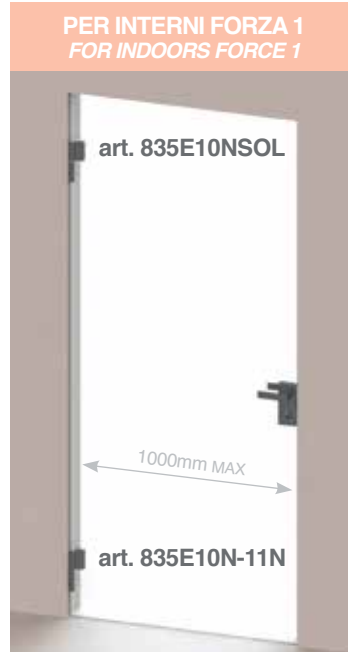

SOLUZIONE - SOLUTION 3

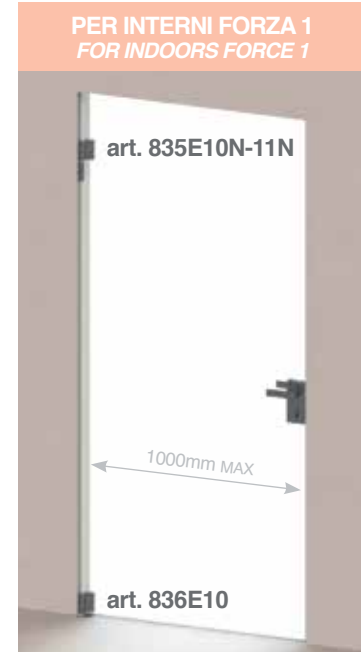

- 2 cerniere Biloba EVO nella versione standard
- Disponibile nelle versioni vetro-muro art.835E10 e vetro-vetro art. 835E50
- Per porte fino a 120 kg
- Anta da 800mm a 1200 mm
- Sp. vetro 8-21.52 mm
- Per esterni
- Forza 3

- 2 bisagras Biloba EVO versión standard
- Disponible en las versiones pared-vidrio art.835E10 y vidrio-vidrio art.835E50
- Para puertas hasta 120 kg
- Ancho de puerta de 800mm a 1200 mm
- Espesor de vidrio 8-21.52 mm
- Para exteriores
- Fuerza 3

- 2 Biloba EVO hinges in the standard version
- Available glass-to-wall, item 835E10 and glass-to-glass item 835E50
- For doors up to 120 kg
- Door width from 800 mm to 1200 mm
- Glass thickness 8 - 21.52 mm
- For outdoors
- Force 3

- 2 Hydraulikbänder Biloba EVO Standard Version
- Verfügbar in der Ausführung Glas-Wand Art.835E10 und Glas-Glas Art. 835E50
- Für Glastüren bis 120 kg
- Türbreite von 800mm bis 1200 mm
- Glasdicke 8-21.52 mm
- Für Außen
- Stärke 3

- 2 charnières Biloba EVO dans la version standard
- Disponible dans les versions verre-art.835E10 et verre-verre art.835E50
- Pour portes jusqu'à 120 kg
- Battant de 800mm à 1200 mm
- Ép. verre 8-21.52 mm
- Pour extérieur
- Force 3

- 1 cerniera Biloba EVO standard 1 cerniera Biloba Evo Libera
- Disponibile nelle versioni vetro-muro art.835E10SOL e vetro-vetro art.835E50SOL
- Per porte fino a 100 kg
- Anta da 600mm a 1000 mm
- Sp. vetro 8-21.52 mm
- Per interni
- Forza 1

- 1 bisagra Biloba EVO standard 1 bisagra Biloba Evo Libre
- Disponible en las versiones pared-vidrio art.835E10SOL y vidrio-vidrio art.835E50SOL
- Para puertas hasta 100 kg
- Ancho de puerta de 600mm a 1000 mm
- Espesor de vidrio 8-21.52 mm
- Para interiores
- Fuerza 1

- 1 standard Biloba EVO 1 free Biloba Evo
- Available glass-to-wall, item 835E10SOL and glass-to-glass item 835E50SOL
- For doors up to 100 kg
- Door width from 600 mm to 1000 mm
- Glass thickness 8 - 21.52 mm
- For indoors
- Force 1

- 1 Hydraulikband Biloba EVO Standard 1 Hydraulikband Biloba Evo mit Freilauf
- Verfügbar in den Ausführungen Glas-Wand Art.835E10SOL und Glas-Glas Art.835E50SOL
- Für Glastüren bis 100 kg
- Türbreite von 600mm bis 1000 mm
- Glasdicke 8-21.52 mm
- Für Innenräume
- Stärke 1

- 1 charnière Biloba EVO standard et 1 charnière Biloba Evo Libre
- Disponible dans les versions verre-mur art.835E10SOL et verre-verre art.835E50SOL
- Pour portes jusqu'à 100 kg
- Battant de 600mm à 1000 mm
- Ép. verre 8-21.52 mm
- Pour intérieur
- Force 1

- 1 cerniera Biloba EVO standard 1 cerniera Biloba Evo Libera fissaggio a terra
- Disponibile nella versioni vetro-muro art.836E10
- Per porte fino a 100 kg
- Anta da 600mm a 1000 mm
- Sp. vetro 8-21.52 mm
- Per interni
- Forza 1

- 1 bisagra Biloba EVO standard 1 bisagra Biloba Evo libre fijación a suelo
- Disponible en la versión pared-vidrio art.836E10
- Para puertas hasta 100 kg
- Ancho de puerta de 600mm a 1000 mm
- Espesor de vidrio 8-21.52 mm
- Para interiores
- Fuerza 1

- 1 standard Biloba EVO 1 lower free Biloba Evo
- Available glass-to-wall item 836E10
- For doors up to 100 kg
- Door width from 600 mm to 1000 mm
- Glass thickness 8 - 21.52 mm
- For indoors
- Force 1

- 1Hydraulikband Biloba EVO Standard 1 Hydraulikband Biloba Evo. Mit Freilauf und Befestigung am Boden
- Verfügbar in der Ausführung Glas-Wand Art.836E10
- Für Glastüren bis 100 kg
- Türbreite von 600mm bis 1000 mm
- Glasdicke 8-21.52 mm
- Für Innenräume
- Stärke 1

- 1 charnière Biloba EVO standard et 1 charnière Biloba Evo. Libre fixation au sol
- Disponible dans les versions verre-mur art.836E10
- Pour portes jusqu'à 100 kg
- Battant de 600mm à 1000 mm
- Ép. verre 8-21.52 mm
- Pour intérieur
- Force 1

cerniere oleodinamiche / oildynamic hinges

Biloba **Evo VELA**



845E10



845E20



Alluminio / Aluminium - finiture / colors 02

Cerniera oleodinamica a scomparsa, per porte con profili in battuta. La prima cerniera di Colcom completamente "nascosta" nel profilo e adattabile ad ogni progetto su richiesta del cliente. Mantiene le consuete e garantite caratteristiche delle cerniere chiudiporta della serie Biloba Evo. Chiusura Oleodinamica. Invisibile perché nascosta nel profilo. Personalizzabile per soddisfare ogni progetto specifico del cliente. Regolazione della velocità di chiusura. Stop a 90°. Misure minime di ingombro 25x25 mm. La cerniera superiore si accompagna ed è abbinata a quella inferiore dedicata.

Bisagra hidráulica escondida, para puertas con marco y tope. La primera bisagra de Colcom completamente escondida dentro el perfil, y adaptable a cualquier proyecto, a petición. Mantiene las mismas características de las bisagras Biloba Evo. Cierrapuerta hidráulico. Invisible – escondida dentro del perfil. Personalizable para satisfacer cualquier proyecto específico. Velocidad de cierre regulable. Fermo a 90°. Dimensiones mínimas 25x25 mm. La aplicación de la bisagra superior se completa con la bisagra inferior dedicada.

Hidden oildynamic doorcloser hinge, for framed doors with a stop. The first Colcom hinge which is completely hidden into the profile, and adaptable to every project upon customer request. It maintains the same features as the Biloba Evo series hinges. Hydraulic Closing. Invisible – hidden into the profile. Customizable, in order to satisfy every specific

project. Adjustability of the closing speed. 90° Stop. Minimum dimensions 25x25 mm. The installation of the upper hinge is completed by the dedicated hidden lower hinge.

Integrierte Hydrauliktürband-, für Anschlagtüren mit Rahmenprofil. Das erste-s Band von Colcom, das komplett im Rahmen integriert ist. Auf Anfrage kann dieses Band Kunden- und Projektspezifisch gefertigt werden. Das Band verfügt über die Merkmale der Biloba Evo Bänder. Hydraulischer Türschließer. Unsichtbar – integriert im Rahmen. Anpassbar, um alle Projektansprüche zu erfüllen. Schließgeschwindigkeit ist einstellbar. 90° Feststellung. Mindestdimension 25x25 mm. Das obere Band und das untere Band bilden das komplette System.

Charnière hydraulique rétractable pour portes avec profil d'arrêt. La première charnière Colcom à « disparaître » complètement dans le profil, adaptable à tous les projets et aux demandes spécifiques du client. Elle possède les mêmes caractéristiques que les charnières ferme-porte de la série Biloba Evo. Ferme-porte hydraulique. Cachée dans le profil, la charnière est invisible. Personnalisable, elle s'adapte au projet spécifique du client. Réglage de la vitesse de fermeture. Arrêt à 90°. Dimensions minimales d'encombrement 25x25 mm. La charnière supérieure est accompagnée de la charnière inférieure adaptée.





845E 10

Biloba Evo VELA oildynamic hinge

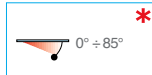
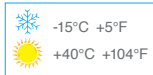
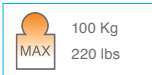

• Cerniera oleodinamica a terra a scomparsa. Per porte con frame in battuta. Velocità di chiusura regolabile e controllo costante di frenatura; permette un'apertura porta fino a 180°. Stop a +90°, anche a 180° secondo progetto parete.

• Bisagra hidráulica oculta de suelo. Para puertas batientes con marco. Velocidad de cierre ajustable y control de frenado constante; permite apertura de puerta hacia 180°. Stop a +90°, también a 180° dependiendo del proyecto de pared.

• Hidden bottom hydraulic hinge. For framed doors with a stop. Adjustable closing speed and constant braking control; the door opens up to 180°. Stop at +90°, and at +180° according to wall project.

• Einklappbares Bodenhydraulikband. Für Anschlagtüren mit Rahmen. Regulierbar Schließgeschwindigkeit und konstanter Kontrolle der Bremsung. Öffnung der Tür bis 180°. Feststellung +90° und +180° (nach Wandprojekt).

• Charnière hydraulique inférieure rétractable pour portes avec profil d'arrêt. Contrôle constant de la vitesse de fermeture; elle permet une ouverture de la porte jusqu'à 180°. Arrêt à +90°, mais aussi à +180° selon le type de paroi.

845E10 R = destra - derecha - right - rechts - droite

845E10 L = sinistra - izquierda - left - links - gauche

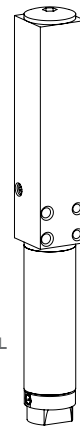

845E10L

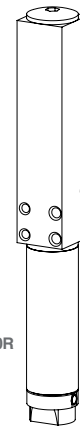

845E10R

* È necessaria una battuta in chiusura in quanto la cerniera ha una precarica. • Necesita de un cierre con tope, puesto que la bisagra tiene una precarga. • The hinge has a loading and it is therefore necessary a closing stop. • Eine Schließfeststellung ist notwendig, weil das Scharnier eine mechanische Belastung hat. • La charnière a une charge, il est donc nécessaire d'avoir un arrêt de fermeture.

Per un ottimale sviluppo del progetto applicazione personalizzato è possibile rivolgersi al nostro ufficio tecnico - Para un óptimo desarrollo del proyecto de aplicación personalizada puede contactar nuestro departamento técnico - In order to have an optimal development of the application, you can consult our technical department - Für eine optimale Entwicklung des Projekts, dürfen Sie sich mit unserem Technischem Büro umdrehen - Pour un développement optimal du projet d'application personnalisée vous pouvez contacter notre service technique.

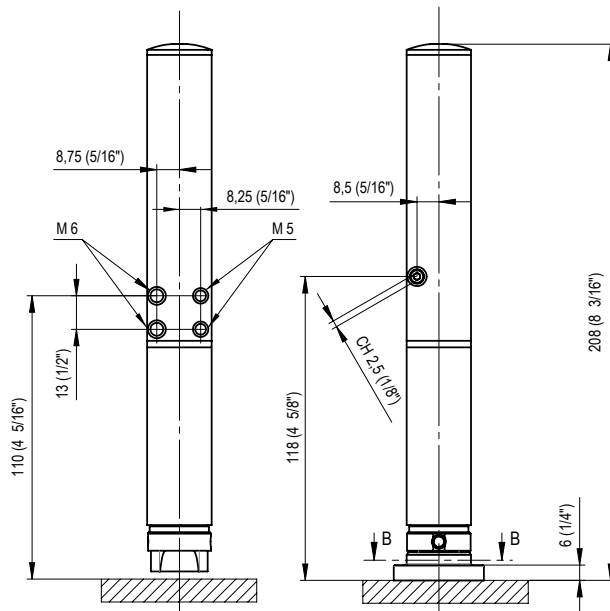

ADATTATORE PER FORO PROFILO
NON INCLUSO
ADJUSTABILITY DEVICE NOT INCLUDED

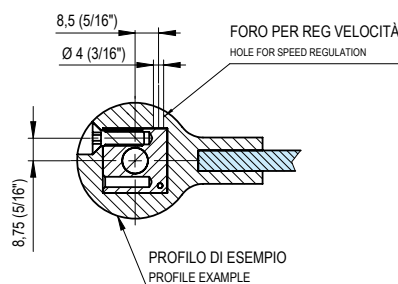
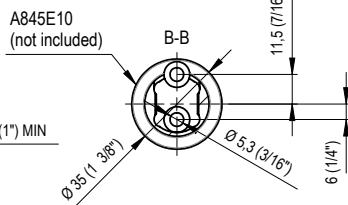
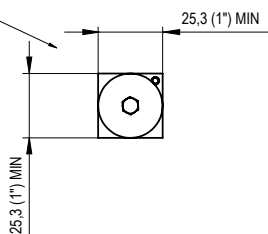

NON COMPRESO
NOT INCLUDED

A845E10



NON COMPRESO
NOT INCLUDED



VITI non comprese
not included SCREWS

PROFILO DI ESEMPIO
PROFILE EXAMPLE

FORO PER REG VELOCITÀ
HOLE FOR SPEED REGULATION

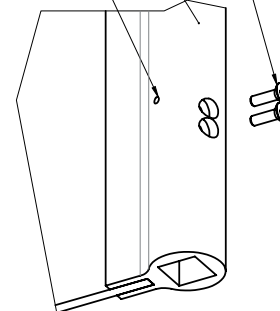

CERNIERA
HINGE

A845E10
BASE non compresa
NOT INCLUDED BASE PLATE

cerniere oleodinamiche / oildynamic hinges

Biloba



8010



8011



8015



8060



Alluminio / Aluminium - finiture / colors 02-05-13-14-15-16-17-22-60-62

Nasce per porte interne e consente la chiusura automatica dell'anta. La velocità del movimento è regolabile e di massima sicurezza in quanto non oppone resistenza. Collaudata per oltre un milione di cicli e coperta da brevetto internazionale. Adatta anche per porte in battuta.

Nació para puertas interiores y permite el cierre automático. La velocidad del movimiento, es ajustable y es segura ya que no resiste. Probadas por más de un millón de ciclos y cubierta por una patente internacional. Puede ser también para puertas con tope.

It is born for inner doors and allows the automatic closing. The moving speed is adjustable and very safety, because the door does not offer resistance. It has been tested for more than one million cycles and is covered by international patent. Also suitable for doors with stop.

Entwickelt wurde für Innentüren, und macht die automatische Schließung möglich. Die Geschwindigkeit der Bewegung ist einstellbar und von maximaler Sicherheit, da die Tür keinen Widerstand leistet, wenn sie unbeabsichtigt fest gestoßen wird. Getestet über eine Millionen Öffnungs- und Schließzyklen und international patent geschützt.

La charnière Biloba est conçue pour les portes intérieures et permet sa fermeture automatique. La vitesse de fermeture est réglable et sécurisée car la porte n'oppose aucune résistance. Elle a été testée pour plus d'un million de cycles et est couverte par un brevet international. Elle est également adaptable aux portes avec butée.





cerniere oleodinamiche / oildynamic hinges

Biloba JC



8010JC



8015JC



Alluminio / Aluminium - finiture / colors 31-32

Le Biloba JC oltre alle consuete caratteristiche oleodinamiche hanno la regolazione del punto 0 e un corpo interno completamente anodizzato. Lo speciale trattamento di ossidazione con alti spessori (20 micron), e il rivestimento dell'intera superficie con copertine in acciaio inox AISI 316, hanno consentito strepitose resistenze alla corrosione, oltrepassando la soglia della 500 ore in nebbia salina/acetica (secondo le norme UNI ISO 9227 AASS Acetic Acid Salt Spray), senza mostrare alcun segno di imperfezione.

Las bisagras "Biloba JC", además de las habituales características hidráulicas tienen ajuste del punto 0°, un cuerpo interior totalmente anodizado. El especial tratamiento de oxidación con alto espesor (20 micras) y el revestimiento de la tapas en acero inoxidable 316 AISI, permitió una resistencia notable a la corrosión, pasando el umbral de 500 horas * niebla salina acética (según UNI ISO 9227 AASS Acetic Acid Salt Spray), sin mostrar ningún signo de imperfecciones.

The Bilobas JC, in addition to the usual hydraulic features, have a zero point adjustability and a completely anodized inner body. The special deep oxidation (20 micron) and the coating of the entire surface with

covers made of stainless steel AISI 316 are very highly resistant to corrosion, more than 500 hours in acetic acid salt spray (according to UNI ISO 9227 AASS Acetic Acid Salt Spray) without showing any sign of imperfection.

Biloba JC, Neben den gewöhnlichen, hydraulischen Merkmalen haben Sie einen inneren 0°-Punkt-Regulierung, komplett eloxierten Körper. Die Sonderoxydationsbehandlung (20 Mikron) und die Verkleidung mit Abdeckungen aus Edelstahl AISI 316 erhöhen die Korrosionsfestigkeit mit erfolgreichen Resultaten (nach UNI ISO 9227 AASS Acetic Acid Salt Spray) ohne Mangel.

La charnière Biloba JC, en plus des mêmes caractéristiques attribuées aux charnières hydrauliques, possède un point zéro réglable et une partie interne entièrement anodisée. L'oxydation profonde spéciale (20 microns) et les capots en acier inoxydable AISI 316 qui recouvrent entièrement la charnière sont très résistants à la corrosion, plus de 500 heures sous test au brouillard salin (selon la norme UNI ISO 9227 AASS Acetic Acid Salt Spray) sans aucune trace d'usures.



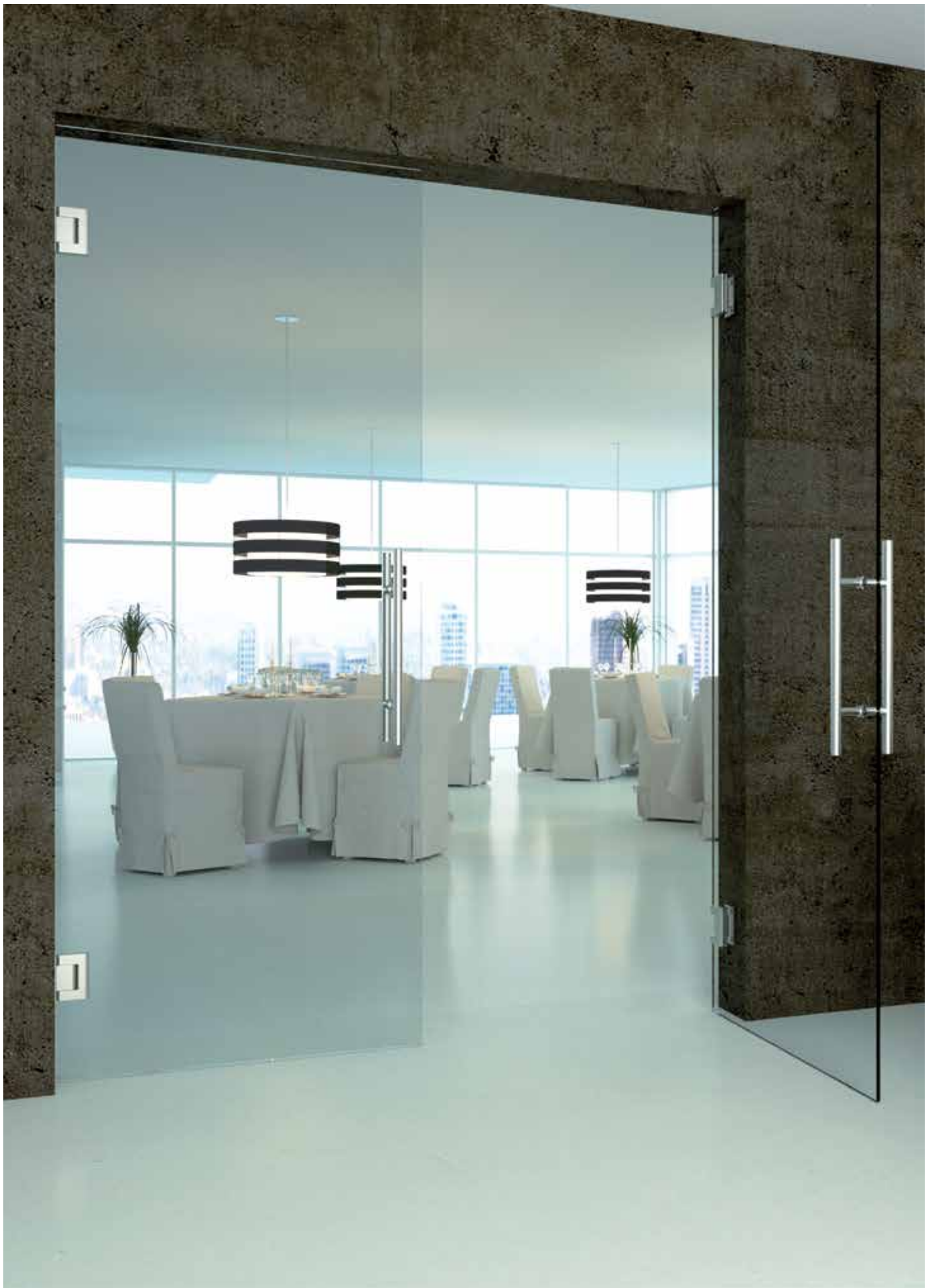

8010

Biloba oildynamic hinge

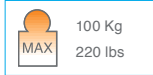
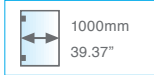
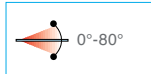

- Cerniera oleodinamica con regolazione delle velocità di chiusura dell'anta. Stop a 0° +90° -90°. Adatta anche per porte in battuta.
- Bisagra cierra puerta hidráulica con ajuste de velocidad de cierre de la puerta. Freno a 0°, +90°, -90°. Adecuada por puertas con tope.
- Hydraulic hinge with adjustment of the closing speed of the door. Stop at 0° +90° -90°. Suitable for doors with stop.
- Hydraulikscharnier mit Feststellung der Türschließgeschwindigkeit. Feststellung bei 0° +90° -90°. Für Anschlagtüren geeignet.
- Charnière hydraulique avec réglage de la vitesse de fermeture du battant. Arrêt à 0°, +90° et -90°. Egalement adaptée pour les portes avec butée.

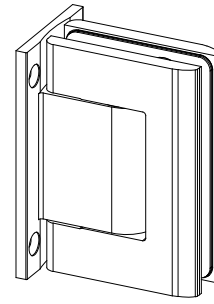

ATTENZIONE - PRECAUCIÓN - CAUTION - ACHTUNG - ATTENTION
 APERTURE VIOLENTE OLTRE I 95° POTREBBERO CAUSARE LO SCARDINAMENTO. È CONSIGLIABILE L'APPLICAZIONE DI UN FERMAPORTA - APERTURA VIOLENTE ADEMÁS DE 95°, PODRÍA CAUSAR DAÑO. ACONSEJAMOS UTILIZAR UN FUA PUERTA. - VIOLENT OPENING FURTHER THAN 95° COULD UNHINGE THE DOOR. WE SUGGEST TO INSTALL A DOOR STOP - HEFTIGE ÖFFNUNGEN MEHRALS 95° KÖNNTEN DIE TÜR AUSHEBEN. WIR SCHLAGEN DIE INSTALLIERUNG EINES TÜRHALTERS VOR - UNE OUVERTURE VIOLENTE AU-DELÀ DE 90° PEUT DEGONDER LA PORTE. IL EST RECOMMANDÉ D'UTILISER UN FERME-PORTE

DISPONIBILE ANCHE NELLE VERSIONI: 1) SENZA FERMI A 90° PER GLI ART.8010, 8011 E 8015 - 2) "L" LIGHT CON MOLLA DEPOINZIATA PER PORTE DI LARGHEZZA INFERIORE A 500 MM. Versioni da specificare in fase d'ordine e soggette a possibili minimi d'ordine. Per ulteriori informazioni contattare l'ufficio commerciale.

TAMBIEN DISPONIBLE: 1) SIN RETENCIÓN A 90° POR LOS ARTICULOS 8010, 8011 Y 8015 - 2) "L" LIGHT - MUELLE CON MENOS FUERZA PARA PUERTAS INFERIORES A 500MM. Se tendrá que especificar en los pedidos y ser objeto de pedido mínimo. Nuestra oficina comercial está a su disposición para ampliar esta o cualquier otra información.

AVAILABLE IN FURTHER TWO VERSIONS: 1) WITHOUT 90° STOP FOR ITEMS 8010, 8011 AND 8015 - 2) "L" LIGHT WITH WEAKENED SPRING FOR DOORS WITH WIDTH LESS THAN 500MM. Both have to be specified on being ordered and could be subjected to minimum quantity order. For further information, please get in touch with the export department.

ES IST AUCH IN ANDEREN 2 VERSIONEN VERFÜGBAR: 1) OHNE 90° ARRETIERUNG FÜR ARTIKELNUMMER 8010, 8011 UND 8015 - 2) "L" LIGHT MIT SCHWÄCHERER FEDER FÜR TÜREN UNTER 500 MM. Beide sind bei der Bestellung anzugeben und könnten eine Mindestbestellmenge verlangen. Für weitere Informationen setzen sie sich mit unserer exportabteilung im kontakt.

EGALEMENT DISPONIBLE EN VERSION: 1) SANS BÛTÉE A 90° POUR LES ART.8010, 8011 E 8015 - 2) "L" LIGHT AVEC RESSORT DE FAIBLE PUISSANCE POUR LES PORTES D'UNE LARGEUR INFERIEURE A 500 MM POUR L'ART.8060. Versions à préciser lors de la commande, éventuellement soumises à des quantités minimum. Pour d'autres informations, veuillez contacter le service commercial.

Classificazione secondo normativa - Clasificación según la ley - Classification according to int'l regulation - Klassifizierung nach den Vorschriften - Classification selon la norme						
art. 8010	UNI EN 1154 : 2006	3	8	2/5	0	1 4

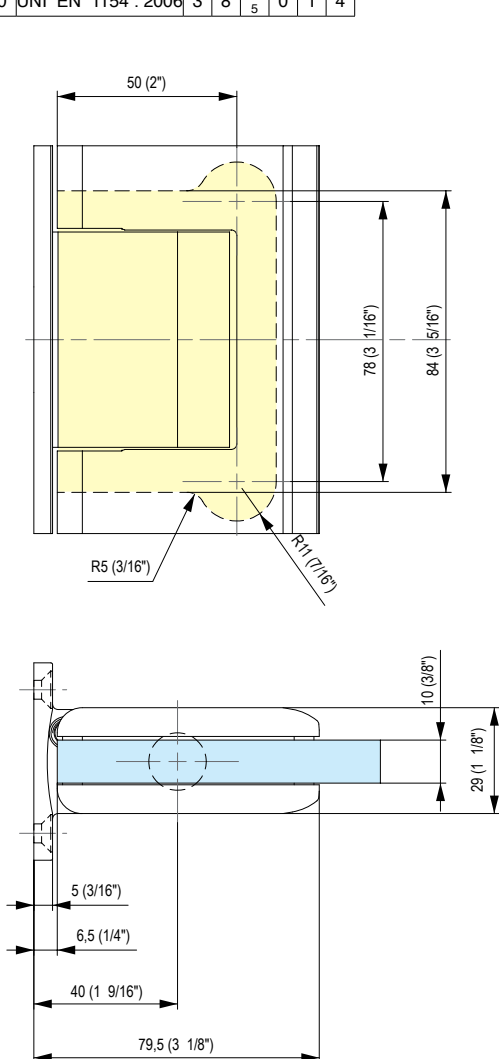

Valvola di regolazione velocità chiusura anta
 Adjustment valve for the door's closing speed

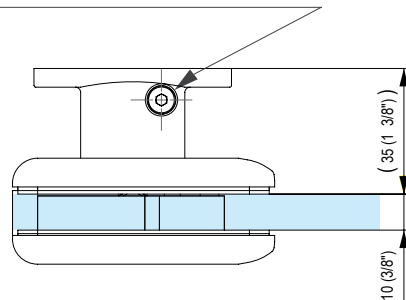

TESTATA 1.000.000 CICLI
 TESTED FOR 1.000.000 CYCLES

8011

Biloba oleodynamic hinge

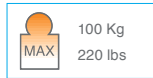
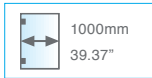
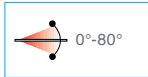

• Cerniera oleodinamica (aletta spostata) con regolazione delle velocità di chiusura dell'anta. Stop a 0° +90° -90°. Adatta anche per porte in battuta.

• Bisagra cierra puerta hidráulica (con aleta desplazada) con ajuste de velocidad de cierre de la puerta. Freno a 0°, + 90°, -90°. Adecuada por puertas con tope.

• Hydraulic hinge (with offset fixing wing) with adjustment of the closing speed of the door. Stop at 0° +90° -90°. Suitable for doors with stop.

• Hydraulischscharnier mit Feststellung der Türschließgeschwindigkeit. Feststellung bei 0° +90° -90°. Einseitige Wandbefestigung für Anschlagtüren geeignet.

• Charnière hydraulique (pattes de fixation déportées à 180°) avec réglage de la vitesse de fermeture du battant. Arrêt à 0°, +90° et -90°. Egalement adapté aux portes avec butées.

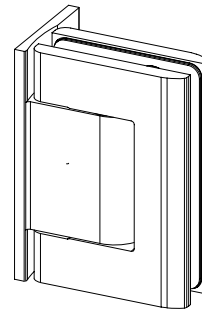

ATTENZIONE - PRECAUCIÓN - CAUTION - ACHTUNG - ATTENTION

APERTURE VIOLENTE OLTRE I 95° POTREBBERO CAUSARE LO SCARDINAMENTO. È CONSIGLIABILE L'APPLICAZIONE DI UN FERMAPORTA - APERTURA VIOLENTE ADEMÁS DE 95°, PODRÍA CAUSAR DAÑO. ACONSEJAMOS UTILIZAR UN FIJA PUERTA. - VIOLENT OPENING FURTHER THAN 95° COULD UNHINGE THE DOOR. WE SUGGEST TO INSTALL A DOOR STOP - HEFTIGE ÖFFNUNGEN MEHRALS 95° KÖNNTEN DIE TÜR AUSHEBEN. WIR SCHLAGEN DIE INSTALLIERUNG EINES TÜRHALTERS VOR - UNE OUVERTURE VIOLENTE AU-DELÀ DE 90° PEUT DEGONDER LA PORTE. IL EST RECOMMANDÉ D'UTILISER UN FERME-PORTE

DISPONIBILE ANCHE NELLE VERSIONI: 1) SENZA FERMI A 90° PER GLI ART.8010, 8011 E 8015 - 2) "L" LIGHT CON MOLLA DEPOWENZIATA PER PORTE DI LARGHEZZA INFERIORE A 500 MM. Versioni da specificare in fase d'ordine e soggette a possibili minimi d'ordine. Per ulteriori informazioni contattare l'ufficio commerciale.

TAMBIEN DISPONIBLE: 1) SIN RETENCIÓN A 90° POR LOS ARTÍCULOS 8010, 8011 Y 8015 - 2) "L" LIGHT - MUELLE CON MENOS FUERZA PARA PUERTAS INFERIORES A 500MM. Se tendrá que especificar en los pedidos y ser objeto de pedido mínimo. Nuestra oficina comercial está a su disposición para ampliar esta o cualquier otra información.

AVAILABLE IN FURTHER TWO VERSIONS: 1) WITHOUT 90° STOP FOR ITEMS 8010, 8011 AND 8015 - 2) "L" LIGHT WITH WEAKENED SPRING FOR DOORS WITH WIDTH LESS THAN 500MM. Both have to be specified on being ordered and could be subjected to minimum quantity order. For further information, please get in touch with the export department.

ES IST AUCH IN ANDEREN 2 VERSIONEN VERFÜGBAR: 1) OHNE 90° ARRETIERUNG FÜR ARTIKELNUMMER 8010, 8011 UND 8015 - 2) "L" LIGHT MIT SCHWÄCHERER FEDER FÜR TÜREN UNTER 500 MM. Beide sind bei der bestellung anzugeben und könnten eine mindestbestellmenge verlangen. Für weitere informationen setzen sie sich mit unserer exportabteilung im kontakt.

EGALEMENT DISPONIBLE EN VERSION: 1) SANS BÛTEE A 90° POUR LES ART.8010, 8011 E 8015 - 2) "L" LIGHT AVEC RESSORT DE FAIBLE PUISSANCE POUR LES PORTES D'UNE LARGEUR INFERIEURE A 700 MM POUR L'ART.8060. Versions à préciser lors de la commande, éventuellement soumises à des quantités minimum. Pour d'autres informations, veuillez contacter le service commercial.

Classificazione secondo normativa - Clasificación según la ley - Classification according to Int'l regulation - Klassifizierung nach den Vorschriften - Classification selon la norme						
art. 8011	UNI EN 1154 : 2006	3	8	2	0	1 4

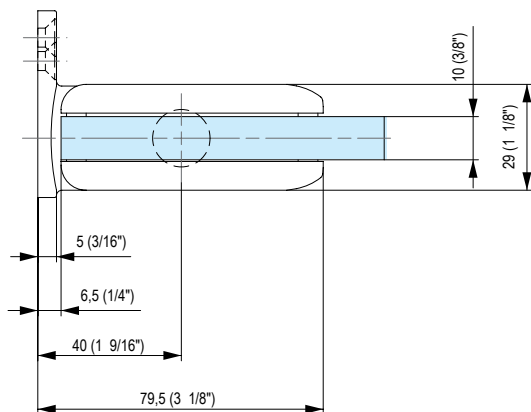
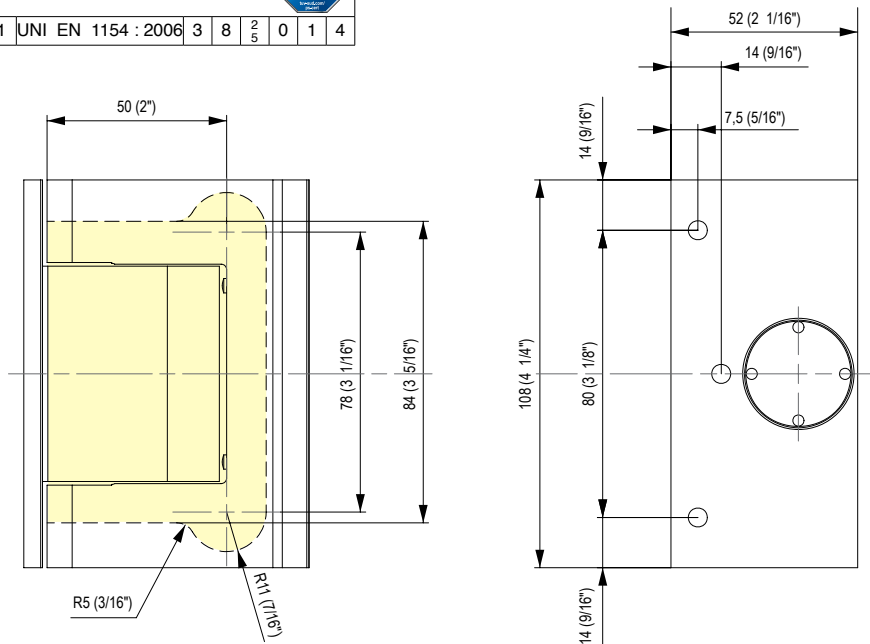

Valvola di regolazione velocità chiusura anta
Adjustment valve for the door's closing speed

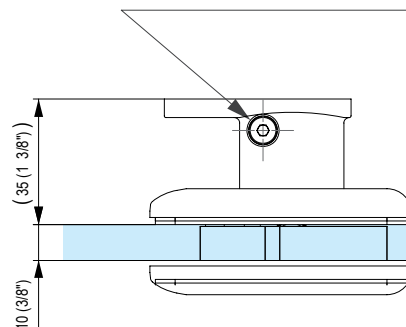

TESTATA 1.000.000 CICLI
TESTED FOR 1.000.000 CYCLES

8015

Biloba oildynamic hinge

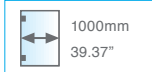
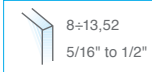
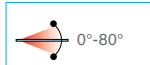

- Cerniera oleodinamica (vetro-vetro 180°) con regolazione delle velocità di chiusura dell'anta. Stop a 0° +90° -90°. Adatta anche per porte in battuta.
- Bisagra cierra puerta hidráulica (vidrio – vidrio 180°) con ajuste de velocidad de cierre de la puerta. Freno a 0°, + 90°, -90°. Adecuada por puertas con tope.
- Hydraulic hinge (glass to glass 180°) with adjustment of the closing speed of the door. Stop a 0° +90° -90°. Suitable for doors with stop.
- Hydraulikscharnier (Glas-Glas 180°) mit Feststellung der Türschließgeschwindigkeit. Feststellung bei 0° +90° -90°. Für Anschlagtüren geeignet.
- Charnière hydraulique (verre-verre 180°) avec réglage de la vitesse de fermeture du battant. Arrêt à 0°, +90° et -90°. Egalement adaptée aux portes avec butée.

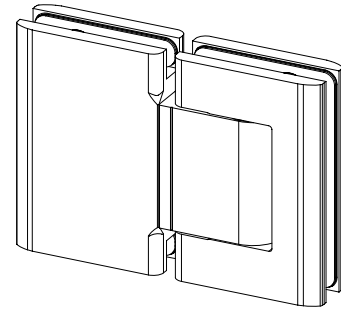

ATTENZIONE - PRECAUCIÓN - CAUTION - ACHTUNG - ATTENTION
 APERTURE VIOLENTE OLTRE I 95° POTREBBERO CAUSARE LO SCARDINAMENTO. È CONSIGLIABILE L'APPLICAZIONE DI UN FERMAPORTA - APERTURA VIOLENTA ADEMÁS DE 95°, PODRIA CAUSAR DAÑO. ACONSEJAMOS UTILIZAR UN FUA PUERTA. - VIOLENT OPENING FURTHER THAN 95° COULD UNHINGE THE DOOR. WE SUGGEST TO INSTALL A DOOR STOP - HEFTIGE ÖFFNUNGEN MEHR ALS 95° KÖNNTEN DIE TÜR AUSHEBEN. WIR SCHLAGEN DIE INSTALLIERUNG EINES TÜRHALTERS VOR - UNE OUVERTURE VIOLENTE AU-DELÀ DE 90° PEUT DEGONDER LA PORTE. IL EST RECOMMANDÉ D'UTILISER UN FERME-PORTE

DISPONIBILE ANCHE NELLE VERSIONI: 1) SENZA FERMI A 90° PER GLI ART.8010, 8011 E 8015 - 2) "L" LIGHT CON MOLLA DEPOWENZIATA PER PORTE DI LARGHEZZA INFERIORE A 500 MM. Versions da specificare in fase d'ordine e soggette a possibili minimi d'ordine. Per ulteriori informazioni contattare l'ufficio commerciale.

TANBIEN DISPONIBLE: 1) SIN RETENCIÓN A 90° POR LOS ARTICULOS 8010, 8011 Y 8015 - 2) "L" LIGHT - MUELLE CON MENOS FUERZA PARA PUERTAS INFERIORES A 500MM. Se tendrá que especificar en los pedidos y ser objeto de pedido mínimo. Nuestra oficina comercial está a su disposición para ampliar esta o cualquier otra información.

AVAILABLE IN FURTHER TWO VERSIONS: 1) WITHOUT 90° STOP FOR ITEMS 8010, 8011 AND 8015 - 2) "L" LIGHT WITH WEAKENED SPRING FOR DOORS WITH WIDTH LESS THAN 500MM. Both have to be specified on being ordered and could be subjected to minimum quantity order. For further information, please get in touch with the export department.

ES IST AUCH IN ANDEREN 2 VERSIONEN VERFÜGBAR : 1) OHNE 90° ARRETIERUNG FÜR ARTIKELNUMMER 8010, 8011 UND 8015 - 2) "L" LIGHT MIT SCHWÄCHERER FEDER FÜR TÜREN UNTER 500 MM. Beide sind bei der bestellung anzugeben und könnten eine mindestbestellmenge verlangen. Für weitere informationen setzen sie sich mit unserer exportabteilung im kontakt.

EGALEMENT DISPONIBLE EN VERSION: 1) SANS BÛTEE A 90° POUR LES ART.8010, 8011 E 8015 - 2) "L" LIGHT AVEC RESSORT DE FAIBLE PUISSANCE POUR LES PORTES D'UNE LARGEUR INFERIEURE A 700 MM POUR L'ART.8060. Versions à préciser lors de la commande, éventuellement soumises à des quantités minimum. Pour d'autres informations, veuillez contacter le service commercial.

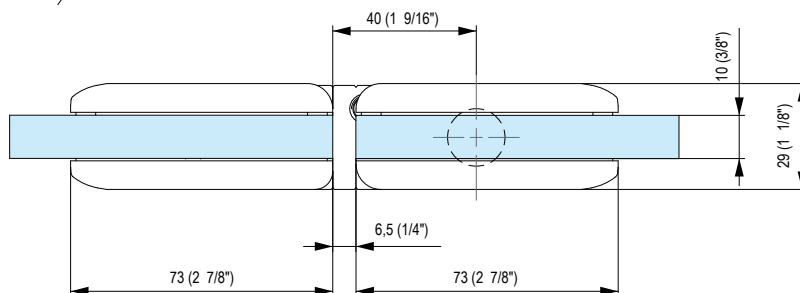
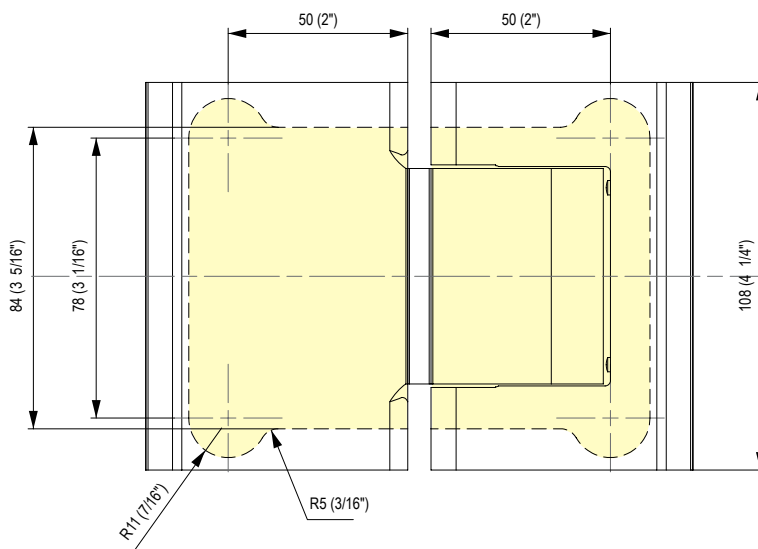

Valvola di regolazione velocità chiusura anta
 Adjustment valve for the door's closing speed

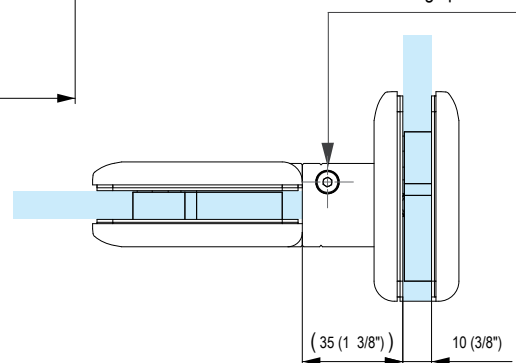

Classificazione secondo normativa - Clasificación según la ley - Classification according to int'l regulation - Klassifizierung nach den Vorschriften - Classification selon la norme						
art. 8015	UNI EN 1154 : 2006	3	8	$\frac{2}{5}$	0	1 4



TESTATA 1.000.000 CICLI
 TESTED FOR 1.000.000 CYCLES

8060

Biloba oleodynamic hinge

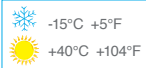
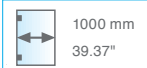
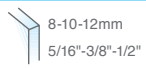
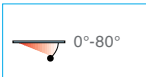

- Cerniera oleodinamica con regolazione delle velocità di chiusura dell'anta per porte in battuta. Ideale per chiusure ermetiche. Stop a 0° +90°.
- Bisagra cierra puerta hidráulica con ajuste de velocidad de cierre de la puerta con tope. Lo perfecto por cerradura hermética. Freno a 0°, + 90°.
- Hydraulic hinge with adjustment of the closing speed of the door with stop. Ideal for hermetic closing. Stop at 0° +90°.
- Automatik- Hydraulikscharnier mit Regulierung der Schließgeschwindigkeit der Tür. Für Anschlagtüren geeignet. Ideal für hermetische Schließung. Feststellung bei 0°+90°.
- Charnière hydraulique avec réglage de la vitesse de fermeture du battant pour porte avec butée. Idéal pour les fermetures hermétiques. Arrêt à 0 +90°.

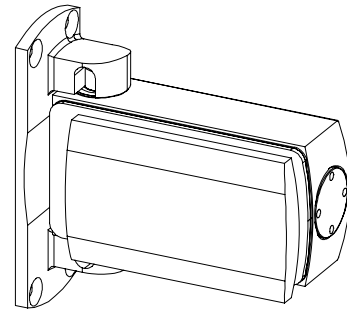

ATTENZIONE - PRECAUCIÓN - CAUTION - ACHTUNG - ATTENTION
 APERTURE VIOLENTE OLTRE I 95° POTREBBERO CAUSARE LO SCARDINAMENTO. È CONSIGLIABILE L'APPLICAZIONE DI UN FERMAPORTA - APERTURA VIOLENTE ADEMÁS DE 95°, PODRIA CAUSAR DAÑO. ACONSEJAMOS UTILIZAR UN FIJA PUERTA. - VIOLENT OPENING FURTHER THAN 95° COULD UNHINGE THE DOOR. WE SUGGEST TO INSTALL A DOOR STOP - HEFTIGE ÖFFNUNGEN MEHR ALS 95° KÖNNEN DIE TÜR AUSHEBEN. WIR SCHLAGEN DIE INSTALLIERUNG EINES TÜRHALTERS VOR - UNE OUVERTURE VIOLENTE AU-DELÀ DE 90° PEUT DEGONDER LA PORTE. IL EST RECOMMANDÉ D'UTILISER UN FERME-PORTE

DISPONIBILE ANCHE NELLE VERSIONI: 1) SENZA FERMI A 90° PER GLI ART.8010, 8011 E 8015 - 2) "L" LIGHT CON MOLLA DEPOTEZIATA PER PORTE DI LARGHEZZA INFERIORE A 500 MM. Versioni da specificare in fase d'ordine e soggette a possibili minimi d'ordine. Per ulteriori informazioni contattare l'ufficio commerciale.

TANBIEN DISPONIBLE: 1) SIN RETENCIÓN A 90° POR LOS ARTICULOS 8010, 8011 Y 8015 - 2) "L" LIGHT - MUELLE CON MENOS FUERZA PARA PUERTAS INFERIORES A 500MM. Se tendrá que especificar en los pedidos y ser objeto de pedido mínimo. Nuestra oficina comercial está a su disposición para ampliar esta o cualquier otra información.

AVAILABLE IN FURTHER TWO VERSIONS: 1) WITHOUT 90° STOP FOR ITEMS 8010, 8011 AND 8015 - 2) "L" LIGHT WITH WEAKENED SPRING FOR DOORS WITH WIDTH LESS THAN 500MM. Both have to be specified on being ordered and could be subjected to minimum quantity order. For further information, please get in touch with the export department.

ES IST AUCH IN ANDEREN 2 VERSIONEN VERFÜGBAR: 1) OHNE 90° ARRETIERUNG FÜR ARTIKELNUMMER 8010, 8011 UND 8015 - 2) "L" LIGHT MIT SCHWÄCHERER FEDER FÜR TÜREN UNTER 500 MM. Beide sind bei der Bestellung anzugeben und könnten eine mindestbestellmenge verlangen. Für weitere Informationen setzen sie sich mit unserer exportabteilung im kontakt.

EQUALMENT DISPONIBLE EN VERSION: 1) SANS BUTÉE A 90° POUR LES ART.8010, 8011 E 8015 - 2) "L" LIGHT AVEC RESSORT DE FAIBLE PUISSANCE POUR LES PORTES D'UNE LARGEUR INFÉRIEURE

Classificazione secondo normativa - Clasificación según la ley - Classification according to int'l regulation - Klassifizierung nach den Vorschriften - Classification selon la norme



art. 8060	UNI EN 1154 : 2006	3	8	2	0	1	4
-----------	--------------------	---	---	---	---	---	---

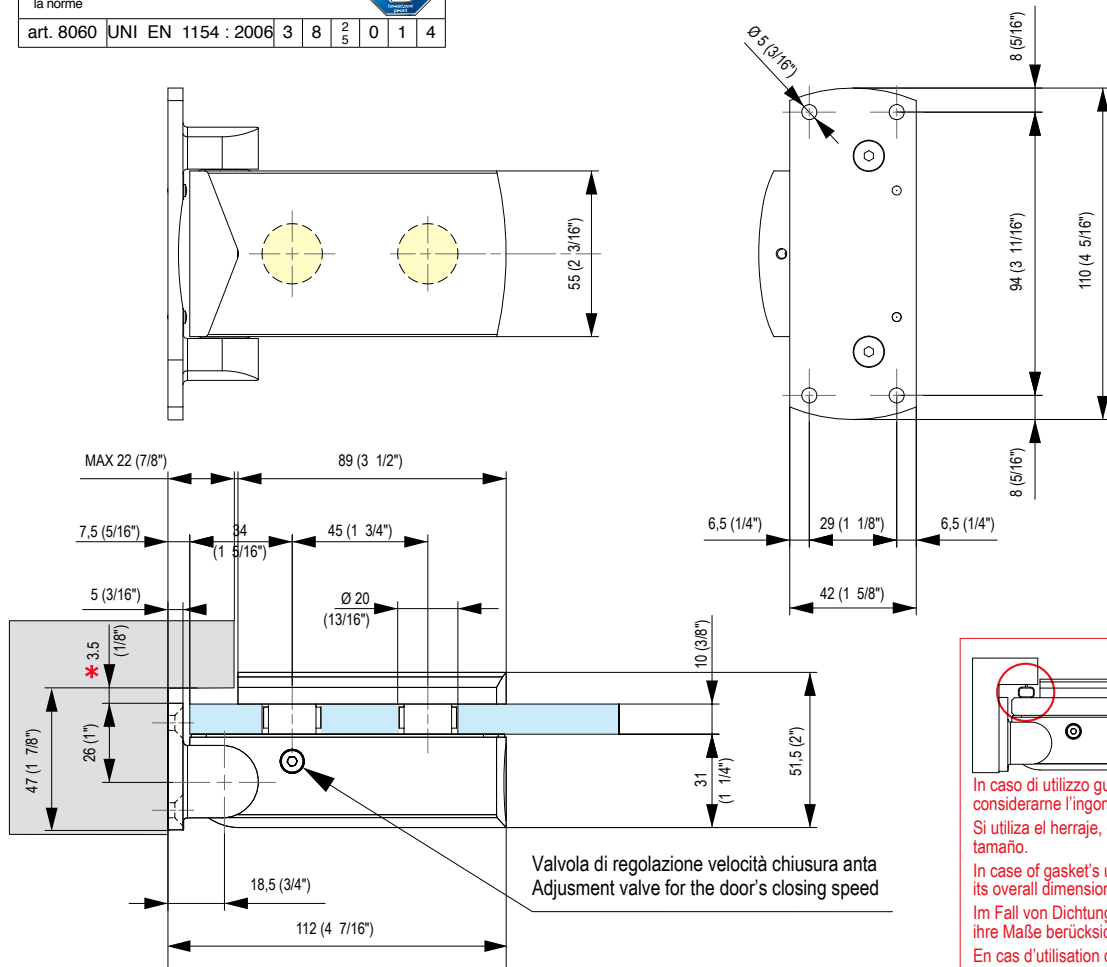

In caso di utilizzo guarnizione, considerarne l'ingombro.
 Si utiliza el herraje, considerar su tamaño.
 In case of gasket's usage, consider its overall dimension.
 Im Fall von Dichtungsverwendung, ihre Maße berücksichtigen.
 En cas d'utilisation d'un joint, tenir compte de son encombrement

- * Distanza minima da filo muro per consentire rotazione vetro
 Distancia minima de hilo pared, para facilitar la rotación del vidrio
 Minimum distance from wall edge in order to facilitate glass rotation
 Mindestdistanz von der Wandkante, um die Glasrotation zu erleichtern
 Distance minimum de l'arrête du mur pour permettre la rotation du verre

TESTATA 1.000.000 CICLI
 TESTED FOR 1.000.000 CYCLES

8010JC

Biloba oildynamic hinge

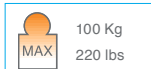
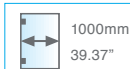
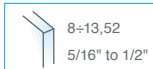
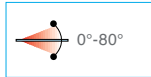

- Cerniera oleodinamica con regolazione delle velocità di chiusura dell'anta e **regolazione del punto 0**. Corpo interno anodizzato, ossidazione profonda (20 micron) e copertina esterna in acciaio inox AISI 316. Stop a 0° +90° -90°.
- Bisagra cierra puerta hidráulica con ajuste de velocidad de cierre de la puerta y **ajuste del punto 0**. Cuerpo interior anodizado con tratamiento de oxidación con alto espesor(20 micron) y tapa exterior en acero inox AISI 316. Freno a 0°, + 90°, -90°.
- Hydraulic hinge with adjustment of the closing speed of the door and **zero point adjustability**. Inner body is anodized with the special deep oxidation (20 micron) and cover made of stainless steel AISI 316. Stop at 0° +90° -90°.
- Hydraulikscharnier mit Feststellung der Türschließgeschwindigkeit und **0°-Punkt-Regulierung**. Der innere Körper ist eloxiert mit Die Sonderoxydationsbehandlung (20 Mikron). Abdeckungen aus Edelstahl AISI 316. Feststellung bei 0° +90° -90°.
- Charnière hydraulique avec réglage de fermeture du battant et réglage du point 0. Partie interne anodisée avec traitement d'oxydation profonde (20 micron) et capot externe en acier inox AISI 316. Arrêt à 0°, +90° et -90°.

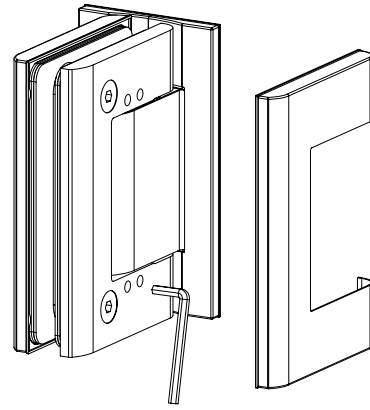

ATTENZIONE - PRECAUCIÓN - CAUTION - ACHTUNG - ATTENTION
 APERTURE VIOLENTE OLTRE I 95° POTREBBERO CAUSARE LO SCARDINAMENTO. È CONSIGLIABILE L'APPLICAZIONE DI UN FERMAPORTA - APERTURA VIOLENTE ADEMÁS DE 95°, PODRIA CAUSAR DAÑO. ACONSEJAMOS UTILIZAR UN FIJA PUERTA. - VIOLENT OPENING FURTHER THAN 95° COULD UNHINGE THE DOOR. WE SUGGEST TO INSTALL A DOOR STOP - HEFTIGE ÖFFNUNGEN MEHR ALS 95° KÖNNTEN DIE TÜR AUSHEBEN. WIR SCHLAGEN DIE INSTALLIERUNG EINES TÜRHALTERS VOR - UNE OUVERTURE VIOLENTE AU-DELÀ DE 90° PEUT DEGONDER LA PORTE. IL EST RECOMMANDÉ D'UTILISER UN FERME-PORTE

NON DOTATA DI FRENO ANTIVENTO - SIN FRENO ANTI VIENTO - NO ANTI-WIND BRAKE - KEINE BREMSEVENTILE MIT WINDSCHUTZFUNKTION - SANS FREIN ANTI-VENT

DISPONIBILE SU RICHIESTA ANCHE NELLA VERSIONE SENZA STOP A 90°. Versione da specificare in fase d'ordine e soggetta a possibili minimi d'ordine. Per ulteriori informazioni contattare l'ufficio commerciale.
 TAMBÉN DISPONIBLE SIN RETENCIÓN A 90°. Se tendrá que especificar en los pedidos y ser objeto de pedido mínimo. Nuestra oficina comercial está a su disposición para ampliar esta o cualquier otra información.
 AVAILABLE IN FURTHER VERSION WITHOUT 90° STOP. It have to be specified on being ordered and could be subjected to minimum quantity order. For further information, please contact the export department.
 ES IST AUCH IN ANDEREN VERSIONE VERFÜGBAR OHNE 90°. Beide sind bei der bestellung anzugeben und könnten eine mindestbestellmenge verlangen. Für weitere informationen setzen sie sich mit unserer exportabteilung im kontakt.
 DISPONIBLE SUR DEMANDE EN VERSION SANS ARRÊT A 90°. Versions à préciser lors de la commande, éventuellement soumises à des quantités minimum. Pour d'autres renseignements, veuillez contacter le service commercial.

Classificazione secondo normativa - Clasificación según la ley - Classification according to int'l regulation Klassifizierung nach den Vorschriften - Classification selon la norme



art. 8010JUNI EN 1154 : 2006 3 8 2/5 0 1 4

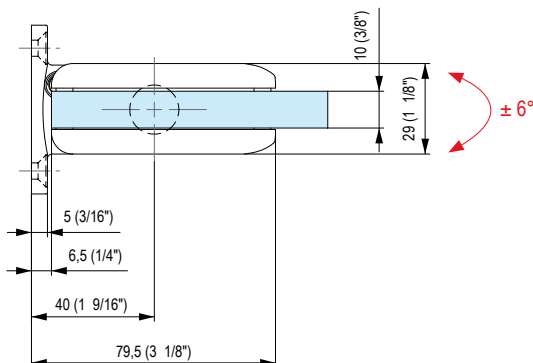
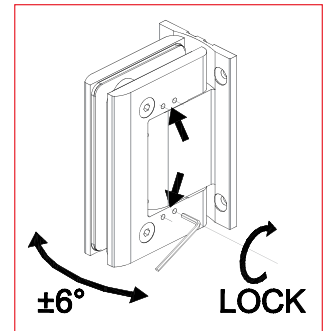
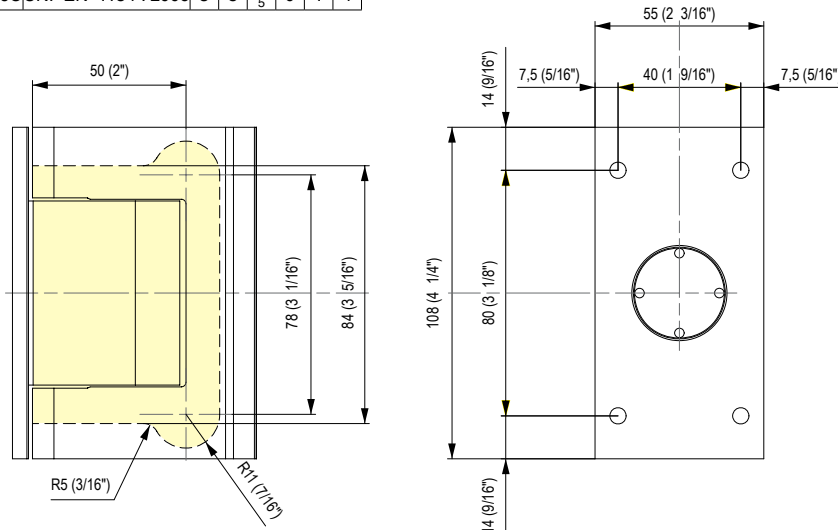

Valvola di regolazione velocità chiusura anta
 Adjustment valve for the door's closing speed

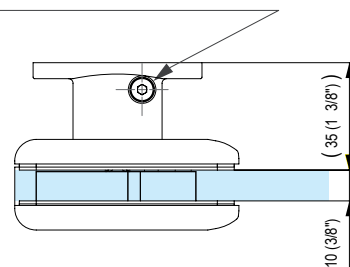

TESTATA 1.000.000 CICLI
 TESTED FOR 1.000.000 CYCLES

8015JC

Biloba oildynamic hinge

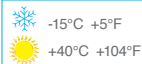
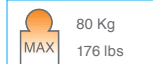
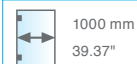
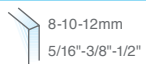
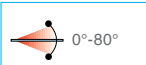

• Cerniera oleodinamica (vetro-vetro 180°) con regolazione delle velocità di chiusura dell'anta e **regolazione del punto 0**. Corpo interno anodizzato, ossidazione profonda (20 micron) e copertina esterna in acciaio inox AISI 316. Stop a 0° +90° -90°.

• Bisagra cierra puerta hidráulica (vidrio-vidrio 180°) con ajuste de velocidad de cierre de la puerta y **ajuste del punto 0**. Cuerpo interior anodizado con tratamiento de oxidación con alto espesor (20 micron) y tapa exterior en acero inox AISI 316. Freno a 0°, +90°, -90°.

• Hydraulic hinge (glass to glass 180°) with adjustment of the closing speed of the door and **zero point adjustability**. Inner body is anodized with the special deep oxidation (20 micron) and cover made of stainless steel AISI 316. Stop at 0° +90° -90°.

• Hydraulischscharnier (Glas-Glas 180°) mit Feststellung der Türschließgeschwindigkeit und **0°-Punkt-Regulierung**. Der innere Körper ist eloxiert mit Die Sonderoxydationsbehandlung (20 Mikron). Abdeckungen aus Edelstahl AISI 316. Feststellung bei 0° +90° -90°.

• Charnière hydraulique (verre-verre 180°) avec réglage de la vitesse de fermeture et réglage du point 0. Partie interne anodisée avec traitement d'oxydation profonde (20 micron). Capot externe en acier inox AISI 316. Arrêt à 0°, +90° et -90°.

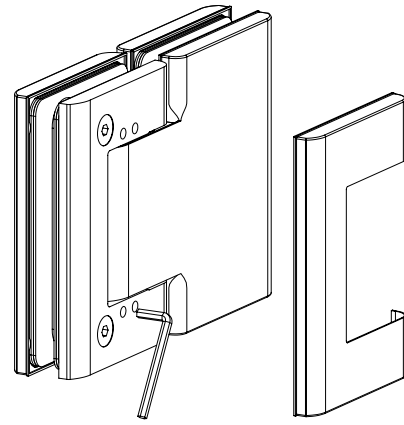

ATTENZIONE - PRECAUCIÓN - CAUTION - ACHTUNG - ATTENTION
 APERTURE VIOLENTE OLTRE I 95° POTREBBERO CAUSARE LO SCARDINAMENTO. È CONSIGLIABILE L'APPLICAZIONE DI UN FERMAPORTA - APERTURA VIOLENTE ADEMÁS DE 95°, PODRIA CAUSAR DAÑO. ACONSEJAMOS UTILIZAR UN FIJA PUERTA. - VIOLENT OPENING FURTHER THAN 95° COULD UNHINGE THE DOOR. WE SUGGEST TO INSTALL A DOOR STOP - HEFTIGE ÖFFNUNGEN MEHR ALS 95° KÖNNTEN DIE TÜR AUSHEBEN. WIR SCHLAGEN DIE INSTALLIERUNG EINES TÜRHALTERS VOR - UNE OUVERTURE VIOLENTE AU-DELÀ DE 90° PEUT DEGONDER LA PORTE. IL EST RECOMMANDÉ D'UTILISER UN FERME-PORTE

NON DOTATA DI FRENO ANTIVENTO - SIN FRENO ANTI VIENTO - NO ANTI-WIND BRAKE - KEINE BREMSEVENTILE MIT WINDSCHUTZFUNKTION - SANS FREIN ANTI-VENT

DISPONIBILE SU RICHIESTA ANCHE NELLA VERSIONE SENZA STOP A 90°. Versione da specificare in fase d'ordine e soggetta a possibili minimi d'ordine. Per ulteriori informazioni contattare l'ufficio commerciale.
 TAMBÉN DISPONIBLE SIN RETENCIÓN A 90°. Se tendrá que especificar en los pedidos y ser objeto de pedido mínimo. Nuestra oficina comercial está a su disposición para ampliar esta o cualquier otra información.
 AVAILABLE IN FURTHER VERSION WITHOUT 90° STOP. It have to be specified on being ordered and could be subjected to minimum quantity order. For further information, please contact the export department.
 ES IST AUCH IN ANDEREN VERSIONE VERFÜGBAR OHNE 90°. Beide sind bei der bestellung anzugeben und könnten eine mindestbestellmenge verlangen. Für weitere informationen setzen sie sich mit unserer exportabteilung im kontakt.
 DISPONIBLE SUR DEMANDE EN VERSION SANS ARRÊT A 90°. Versions à préciser lors de la commande, éventuellement soumises à des quantités minimum. Pour d'autres renseignements, veuillez contacter le service commercial.

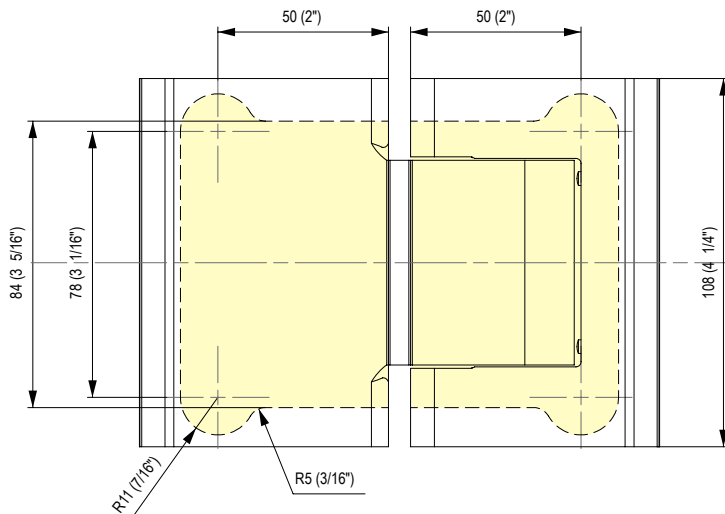

Classificazione secondo normativa - Clasificación según la ley - Classification according to int'l regulation Klassifizierung nach den Vorschriften - Classification selon la norme

art. 8015JC	UNI EN 1154	2006	3	8	2/5	0	1	4
-------------	-------------	------	---	---	-----	---	---	---

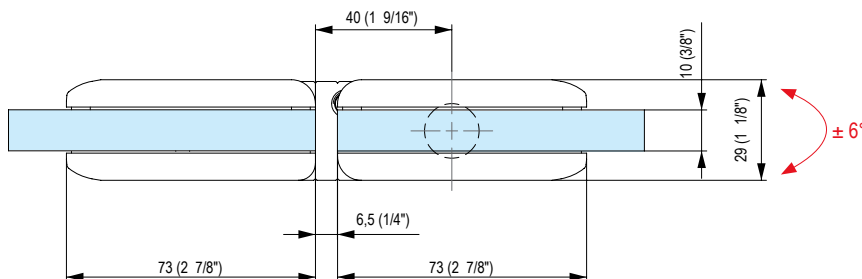
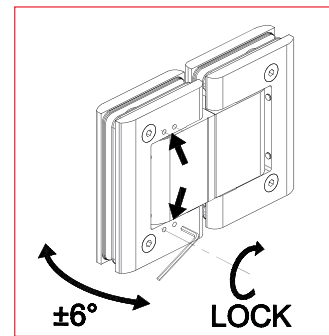

Valvola di regolazione velocità chiusura anta
 Adjustment valve for the door's closing speed

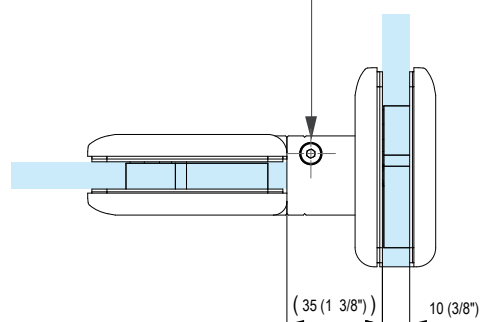

TESTATA 1.000.000 CICLI
 TESTED FOR 1.000.000 CYCLES

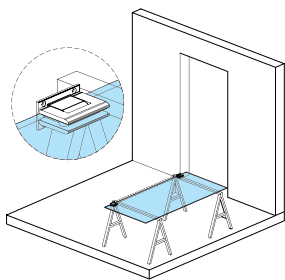

- 1 Premontare le cerniere allineandole tra loro.
- 1 Alinear las bisagras.

1 Mount the hinges and align them.

1 Vormontage der Scharnieren und Ihre Fluchtung.

1 Pré-assembler les gonds en les alignant les uns aux autres.

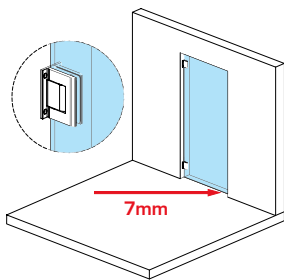

- 2 Segnare i 4 fori a muro e fissare mediante l'utilizzo di tasselli appositi.
- 2 Hacer los 4 agujeros y fijar las bisagras a la pared.

2 Sign the 4 holes on the wall and fix using the appropriate dowels.

2 Anzeichnung der 4 Löcher an der Wand und Fixierung mit dem Gebrauch von den dazu bestimmten Dübeln.

2 Marquer les 4 trous au mur et sécuriser grâce à l'utilisation de la fixation spéciale.

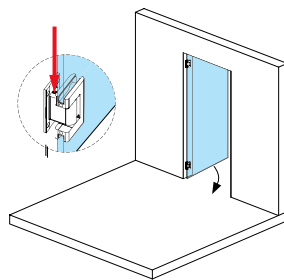

- 3 Aprire la porta e regolare le valvole.
- 3 Abrir la puerta y regular las válvulas.

3 Open the door and adjust the valves.

3 Öffnung der Tür und Einstellung der Ventile.

3 Ouvrir la porte et ajuster les valves.

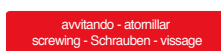
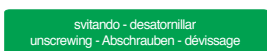

REGOLAZIONI DELLE VALVOLE

Le cerniere oleodinamiche, vengono fornite con le valvole di regolazione completamente chiuse. (a porta montata infatti, essa non potrà chiudersi.)

Affinché le valvole lavorino in maniera ottimale, è necessario che siano ben sincronizzate; per ottenere questo, è fondamentale seguire le seguenti procedure: 1. Mettere la porta in posizione di apertura 60°- 70°.

2. Agire sulle valvole di una delle due cerniere verificando che la porta inizi a chiudersi automaticamente.

3. Per ottenere la velocità di chiusura desiderata intervenire sul grano di regolazione della valvola.

4. Tramite la regolazione della valvola della seconda cerniera, verificare che la velocità di chiusura aumenti.

Ora, chiudere leggermente la valvola sino alla velocità di chiusura desiderata.

La cerniera è ambidestra, quindi vi saranno installazioni in cui la valvola sarà posizionata verso l'alto e altre in cui sarà posizionata verso il basso, questo non andrà comunque a compromettere la funzionalità dell'articolo, sarà a discrezione dell'installatore decidere l'eventuale posizionamento.

AVVERTENZE:

Per verificare che le due cerniere siano state installate correttamente, aprire la porta PRIMA CHE ARRIVI IN BATTUTA, verificando che nessuna delle due cerniere faccia rumore. Nel caso in cui una delle cerniere risulti rumorosa, bisognerà intervenire allentando leggermente la valvola per allinearla alla cerniera silenziosa. La cerniera rumorosa è quella con la regolazione più lenta rispetto all'altra, sarà a discrezione dell'installatore se aprire leggermente la valvola della cerniera rumorosa oppure chiudere leggermente la valvola della cerniera silenziosa, in modo da allinearle correttamente.

N.B. ATTENZIONE! NON SVITARE MAI DEL TUTTO GLI UGELLI (FUORI USCITA OLIO IN PRESSIONE!) NON RISPONDIAMO DI EVENTUALI RESI CON UGELLO SVITATO

REGULACIÓN DE LAS VÁLVULAS DE LA BISAGRA

Las bisagras hidráulicas se suministran con las válvulas de ajuste completamente cerradas (con la puerta montada, efectivamente, ésta no se podrá cerrar). Para que las válvulas funcionen de manera óptima, es necesario que estén bien sincronizadas, para ello es fundamental seguir el siguiente procedimiento:

1. Poner la puerta en posición de apertura a 60°- 70°.

2. Regular las válvulas de una de las dos bisagras comprobando que la puerta comience a cerrarse automáticamente.

3. Para obtener la velocidad de cierre deseada ajustar el tornillo de regulación de la válvula.

4. Mediante la regulación de la válvula de la segunda bisagra, comprobar que la velocidad de cierre aumente.

A continuación cerrar ligeramente la válvula hasta la velocidad de cierre deseada.

La bisagra es ambivalente, por tanto habrá instalaciones en que la válvula esté colocada hacia arriba y otras en que esté colocada hacia abajo, de todas formas esto no afectará a la funcionalidad del producto, quedando a discreción del instalador decidir su posible colocación.

ADVERTENCIAS:

Para comprobar que las dos bisagras estén instaladas correctamente, abrir la puerta ANTES DE QUE LLEGUE AL TOPE, comprobando que ninguna de las dos bisagras haga ruido. Caso que una de las bisagras resulte ruidosa, será necesario aflojar ligeramente la válvula para alinearla con la bisagra silenciosa. La bisagra ruidosa es la que tiene la regulación más floja respecto a la otra, quedará a discreción del instalador decidir si abrir ligeramente la válvula de la bisagra ruidosa o cerrar ligeramente la válvula de la bisagra silenciosa, para alinearlas correctamente.

N.B. COLCOM NO REPONE LAS BISAGRAS CON LA TOBERA DE AJUSTE DESATORNILLADA.

ADJUSTMENT OF THE VALVES

The oil-pressure hinges are supplied with the control valves completely closed (once the door is mounted, it will not close). As the valves do the optimal function, it is necessary that they are well synchronised.

1. Place the door in the opening position at 60°- 70°

2. Act on the valves of one of the two hinges and check that the door start to close automatically.

3. In order to obtain the desired speed, act on the dowel of the adjustment valve.

4. Act on the valve of the second hinge and check that the door increases its speed.

Now close again the valve slightly till you will obtain the optimal speed. As the hinge is both-hands, there will be applications where the valve will be positioned upwards and applications where the valve will be positioned downwards. This latter will not compromise the functionality of the article; the installer will decide how to position the valve.

WARNING:

The check that the both hinges have been installed correctly, is done by opening the door BEFORE IT CLOSES, making sure that neither of the hinges make a noise. If one of the hinges makes a noise, it will be necessary to act by slightly loosen the valve in order to align it to the silent hinge. The noisy hinge is the one with the slower adjustment.

The installer will decide if: 1- Slightly open the noise hinge or 2- Slightly close the silent hinge, in order to align them correctly.

NOTE : ATTENTION ! DO NOT NEVER LOOSEN THROUGH AND THROUGH (OIL LEAKAGE ON PRESSION) AS WE ARE NOT LIABLE FOR ANY RETURN BY LOOSING NOZZLE.

EINSTELLUNG DER VENTILE

Die hydraulischen Scharniere werden mit vollständig geschlossenen Regelventilen geliefert (bei montierter Tür kann sich das Scharnier nicht schließen). Damit die Ventile optimal arbeiten, müssen sie gut synchronisiert sein. Hierfür ist nachstehendes Verfahren von absoluter Wichtigkeit:

1. Die Tür in die Öffnungsstellung von 60°- 70° bringen

2. Auf das Ventil von einem der beiden Scharniere einwirken und überprüfen, dass sich die Tür automatisch zu schließen beginnt.

3. Zum Erreichen der gewünschten Schließgeschwindigkeit den Einstellstift des Ventils justieren.

4. Anhand der Einstellung des Ventils des zweiten Scharniers überprüfen, dass sich die Geschwindigkeit steigert.

Nun das Ventil bis zur gewünschten Schließgeschwindigkeit vorsichtig schließen.

Das Scharnier ist zweiseitig. Bei der Installationen kann das Ventil daher entweder nach oben oder nach unten gerichtet sein, was jedoch die Funktionstüchtigkeit des Artikels nicht beeinträchtigt. Die jeweilige Stellung liegt im Ermessen des Installateurs.

HINWEISE:

Um zu überprüfen, ob die beiden Scharniere korrekt installiert wurden, muss die Tür geöffnet werden, BEVOR SIE ZUM ANSCHLAG KOMMT, wobei kontrolliert werden muss, dass keines der beiden Scharniere ein Geräusch macht. Wenn eines der Scharniere Geräusche macht, muss das Ventil leicht gelockert werden, um es an das geräuschvolle Scharnier anzupassen. Das geräuschvolle Scharnier ist das, das langsamer als das andere Scharnier eingestellt ist. Es liegt im Ermessen des Installateurs, ob das Ventil des geräuschvollen Scharniers leicht geöffnet oder das Ventil des geräuschlosen Scharniers leicht geschlossen wird, um sie einwandfrei aufeinander abzustimmen.

N.B.: ACHTUNG! DIE DÜSEL NIE KOMPLETT AUSSCHRAUBEN, SONST WIRD DAS ÖL UNTER DRUCK RAUS KOMMEN !! IN DIESEM FALL WERDEN WIR FÜR RETURNLIEFERUNGEN MIT AUSGESCHRAUBTER DÜSE NICHT HAFTEN.

AJUSTEMENT DES VALVES

Les charnières hydrauliques sont munies de valves de régulation complètement closes. (la porte montée, elle ne pourra pas se fermer).

Afin que les valves travaillent de manière optimale, il est nécessaire qu'elles soient bien synchronisées; pour se faire, il est primordial de suivre les procédures suivantes:

1. Mettre la porte en position d'ouverture 60°- 70°

2. Appuyer sur les valves d'une des deux charnières en vérifiant que la porte commence à se fermer automatiquement.

3. Pour obtenir la vitesse de fermeture désirée, appuyer sur le grain de réglage de la valve.

4. En réglant la valve de la deuxième charnière, vérifier que la vitesse de fermeture augmente.

Ensuite, fermer légèrement la valve jusqu'à la vitesse de fermeture souhaitée. La charnière fonctionne dans les deux sens, il y aura donc des installations où la valve sera positionnée vers le haut et d'autres où la valve sera positionnée vers le bas. Cela ne va pas cependant compromettre la fonctionnalité de la charnière, se sera à l'installateur de décider du positionnement de la charnière.

AVERTISSEMENT:

Pour vérifier que les deux charnières sont installées correctement, ouvrir la porte AVANT D'ARRIVER EN BUTÉE, en vérifiant qu'aucune des deux charnières ne fasse de bruit. Dans le cas où l'une des deux soit bruyante, il faudra intervenir et desserrer légèrement la valve en l'alignant avec la charnière silencieuse. La charnière bruyante est celle qui a le réglage le plus lent par rapport à la seconde, l'installateur devra ouvrir la valve de la charnière bruyante ou fermer légèrement celle de la charnière silencieuse, afin de les aligner correctement.

N.B. ATTENTION! NE PAS DÉVISSER TOTALEMENT (FUITE D'HUILE SUR PRESSION) NOUS NE SOMMES PAS RESPONSABLES EN CAS D'EVENTUELS RETOURS DE VALVES DÉVISSÉES.



cerniere oleodinamiche / oildynamic hinges

Bilobina Centrale



825E00



825E10



825E50



Zama / Zamak - finiture / colors 13-14-15 (art.825E00 solo finitura/only color 14)

Permette l'apertura della porta sia verso l'interno che verso l'esterno (double-way). Ha all'interno un cuore oleodinamico unico per funzionalità, che rende questa cerniera un chiudiporta a tutti gli effetti con la caratteristica chiusura automatica, dolce e controllata dell'anta. Bilobina centrale ha la possibilità di regolare il punto zero di $\pm 3^\circ$. È disponibile nella versione vetro-vetro e vetro-muro, quest'ultima prevede anche la versione con piastrina spostata. È coperta da brevetto internazionale ed ha superato i più severi test di corrosione in AASS.

Permite la abertura de la puerta tanto hacia el interior como hacia el exterior (vay vén). Por dentro tiene un núcleo hidráulico, único por su funcionalidad, que convierte esta bisagra en un verdadero cierrapuerta con el típico cierre automático, dulce y controlado del batiente. Con Bilobina centrale puedes ajustar el punto cero de $\pm 3^\circ$. Disponible tanto en la versión vidrio-vidrio como en la vidrio-muro. Esta última admite la versión con plaqueta desplazada también. Es cubiertas por una patente internacional y ha pasado los test de corrosión AASS más estrictos de las bisagras hidráulicas de Colcom.

Allows the door to open both inwards and outwards (double-way). It has a hydraulic mechanism which makes it, in fact, a door closer with its characteristic automatic and controlled closing. With Bilobina Centrale you can adjust the zero point up to $\pm 3^\circ$.

Available glass-glass and glass-wall versions, the latter one also includes the offset mounting plate. Covered by international patent and passed the most severe corrosion tests in AASS.

Diese Version ermöglicht es, dass die Tür in beide Richtungen, Einwärts und Auswärts geöffnet wird (Pendeltür). Das Band hat einen hydraulischen Mechanismus, der es mit einem Türschließer hinsichtlich der Eigenschaften, automatische und kontrollierte Schließung gleichsetzt. Mit Bilobina Centrale lässt sich die Nulllage um $\pm 3^\circ$ regulieren. Verfügbar in Glas-Glas und Glas-Wand Ausführung, letztere auch mit einseitiger Anschraubplatte. Geschützt mit internationalem Patent und Korrosionseigenschaften erfolgreich geprüft nach den harten Bedingungen der Essigsäure-Salzsäuretests (AASS).

Permet l'ouverture de la porte à la fois vers l'intérieur et vers l'extérieur (double-way). Elle possède un mécanisme hydraulique interne, ce qui en fait un véritable ferme-porte avec sa fermeture automatique caractéristique, douce et contrôlée. Avec Bilobina centrale vous pouvez ajuster le point zéro de $\pm 3^\circ$. Elle est disponible dans les versions verre-verre et verre-mur, cette dernière incluant également la version avec une plaque de montage déportée. Elle est couverte par un brevet international et a passé les tests de corrosion les plus rigoureux en AASS.



825E00

Bilobina oildynamic hinge

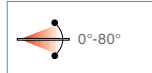
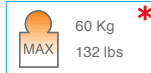
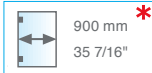
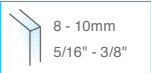

- Cerniera idraulica vetro-muro con automatismo di chiusura integrato. Stop a 0° +90° -90°. Regolazione allineamento 0° ±3°.
- Bisagra oleodinámica vidrio-muro con automatismo de cierre integrado. Estop 0° +90° - 90°. Regulación de ajuste 0° ±3°.
- Glass-wall hydraulic hinge with integrated closing automatism. Stop at 0° + 90° -90°. Alignment adjustable to 0° ±3°.
- Hydraulikband Glas/Wand mit integriertem Türschließer. Stop 0° +90° - 90°. Richtungsregelierung 0° ±3°.
- Charnière hydraulique verre-mur avec automatisme de fermeture intégrée. Arrêt à 0°, + 90° et -90°. Régulation d'alignement à 0° et ±3°.

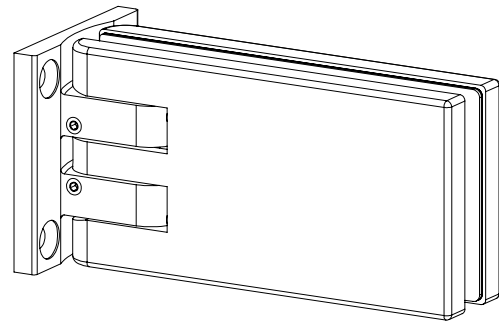

* Per porte con peso superiore ai 50 kg e di larghezza oltre 800 mm si consiglia l'utilizzo di n° 3 cerniere • Para puertas con un peso superior a los 50 kg y con más de 800 mm de ancho se aconseja utilizar 3 bisagras • For doors with weight higher than 50 Kgs and largeness higher than 800 mm we suggest to use 3 hinges • Für Türe mit größerem Gewicht als 50 Kgs und größerer Breite als 800 mm schlagen wir die Verwendung von 3 Beschlägen vor • Dans le cas d'une utilisation pour une porte dont le poids est supérieur à 50 kg et la hauteur supérieure à 800 mm, nous vous suggérons l'utilisation de 3 charnières

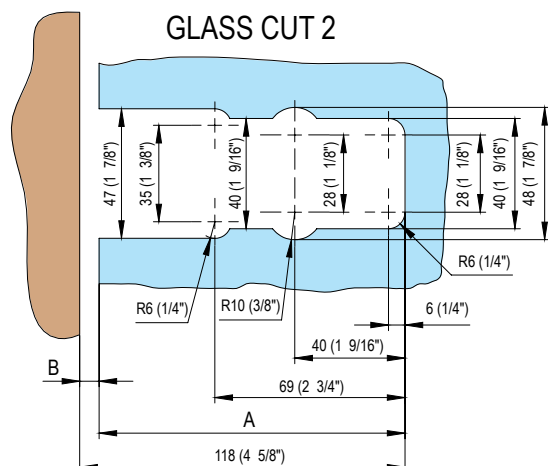
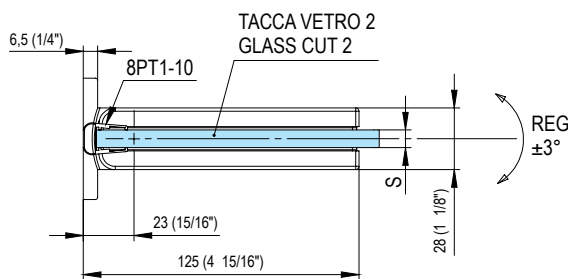
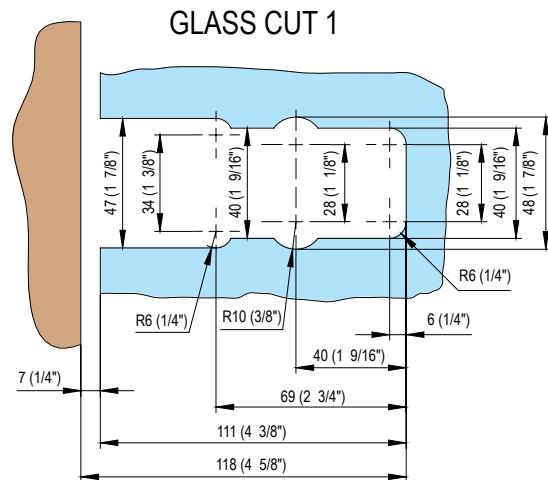
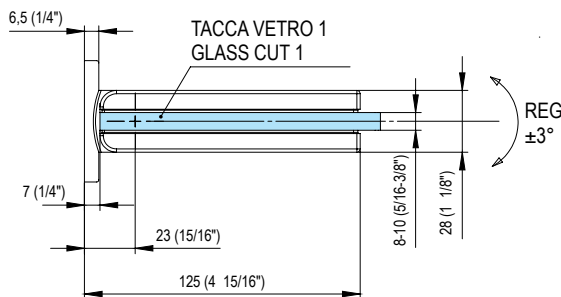
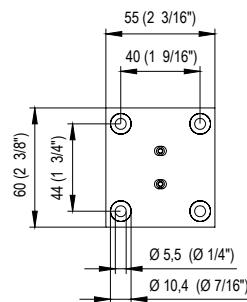
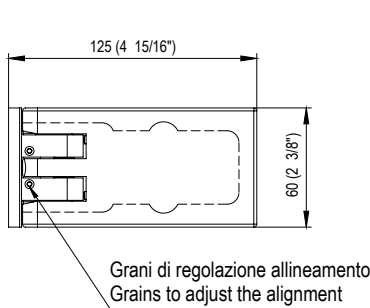

S	A	B
8 (5/16")	112 (4 13/32")	6 (1/32")
10 (3/8")	110 (4 11/32")	8 (5/16")

825E10

Bilobina oildynamic hinge



- Cerniera idraulica vetro-muro con automatismo di chiusura integrato. Aletta spostata. Stop a 0° +90° -90°. Regolazione allineamento 0° ±3°.
- Bisagra oleodinámica vidrio-muro con automatismo de cierre integrado. Aleta desplazada. Estop 0° +90° - 90°. Regulación de ajuste 0° ±3°.
- Glass-wall hydraulic hinge with integrated closing automatism. Off-set wing. Stop at 0° + 90° -90°. Alignment adjustable to 0° ±3°.
- Hydraulikband Glas/Wand mit integriertem Türschließer Verschiebenflosse. Stop 0° +90° - 90°. Richtungsregelierung 0° ±3°.
- Charnière hydraulique verre-mur avec automatisme de fermeture à ancrage non symétrique intégré. Arrêt à 0°, + 90° et -90°. Régulation d'alignement à 0° et ±3°.

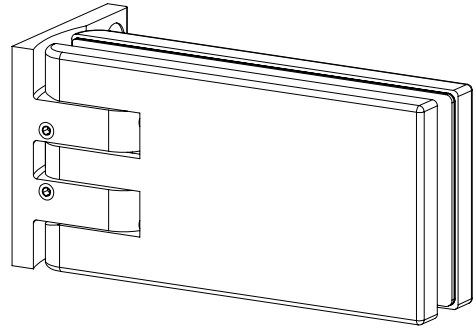

* Per porte con peso superiore ai 50 kg e di larghezza oltre 800 mm si consiglia l'utilizzo di n° 3 cerniere • Para puertas con un peso superior a los 50 Kgs y con más de 800 mm de ancho se aconseja utilizar 3 bisagras • For doors with weight higher than 50 Kgs and largeness higher than 800 mm we suggest to use 3 hinges • Für Türe mit größerem Gewicht als 50 Kgs und größerer Breite als 800 mm schlagen wir die Verwendung von 3 Beschlägen vor • Dans le cas d'une utilisation pour une porte dont le poids est supérieur à 50 kg et la hauteur supérieure à 800 mm, nous vous suggérons l'utilisation de 3 charnières

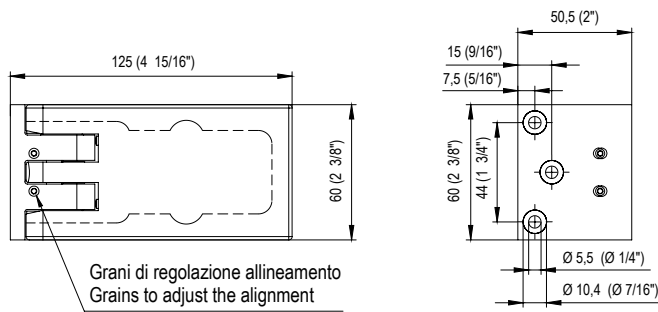

Grani di regolazione allineamento
Grains to adjust the alignment

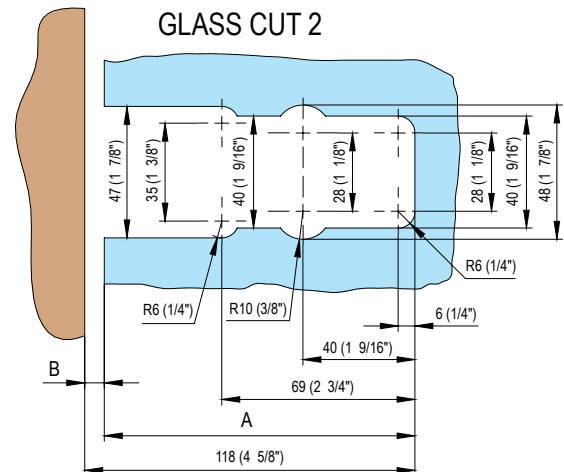
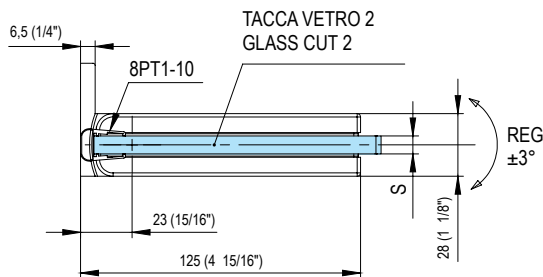
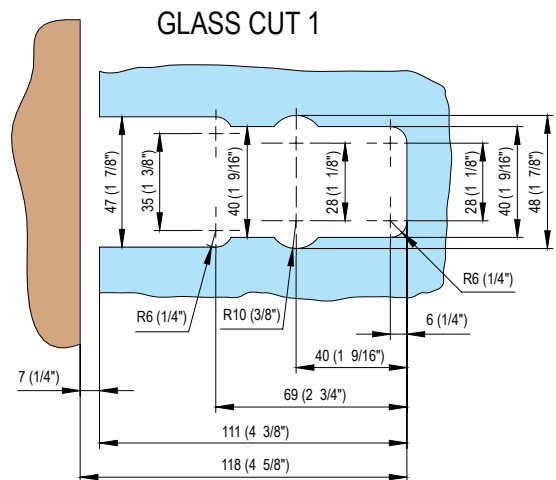
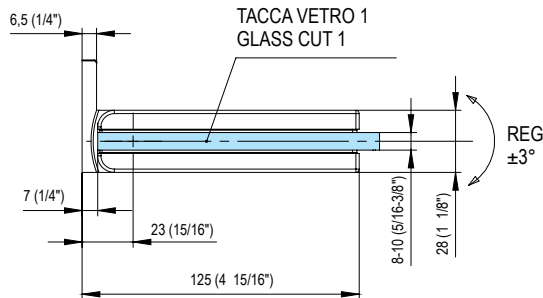

S	A	B
8 (5/16")	112 (4 13/32")	6 (1/32")
10 (3/8")	110 (4 11/32")	8 (5/16")

825E50

Bilobina oildynamic hinge

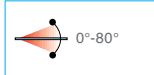
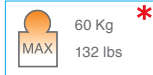
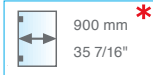
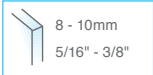

- Cerniera idraulica Vetro-Vetro con automatismo di chiusura integrato. Stop a 0° +90° -90°. Regolazione allineamento 0° ±3°.
- Bisagra oleodinámica vidrio-vidrio con automatismo de cierre integrado. Aleta desplazada. Estop 0° +90° - 90°. Regulación de ajuste 0° ±3°.
- Hydraulic glass-glass hinge with integrated closing automatism. Off-set wing. Stop at 0° + 90° -90°. Alignment adjustable to 0° ±3°.
- Hydraulikband Glas/Glas mit integriertem Türschließer Verschiebenflosse. Stop 0° +90° - 90°. Richtungsregelierung 0° ±3°.
- Charnière hydraulique verre-verre avec automatisme de fermeture intégré. Arrêt à 0°, + 90° et -90°. Régulation d'alignement à 0°+ et ±3°.

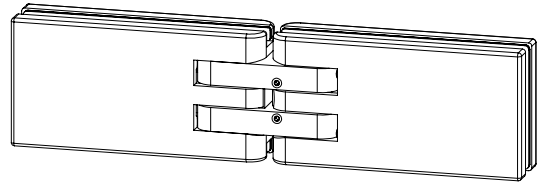

* Per porte con peso superiore ai 50 kg e di larghezza oltre 800 mm si consiglia l'utilizzo di n° 3 cerniere • Para puertas con un peso superior a los 50 Kgs y con más de 800 mm de ancho se aconseja utilizar 3 bisagras • Für Türe mit größerem Gewicht als 50 Kgs und größerer Breite als 800 mm schlagen wir die Verwendung von 3 Beschlägen vor • Dans le cas d'une utilisation pour une porte dont le poids est supérieur à 50 kg et la hauteur supérieure à 800 mm, nous vous suggérons l'utilisation de 3 charnières

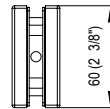
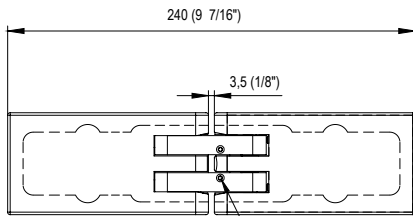

Grani di regolazione allineamento
Grains to adjust the alignment

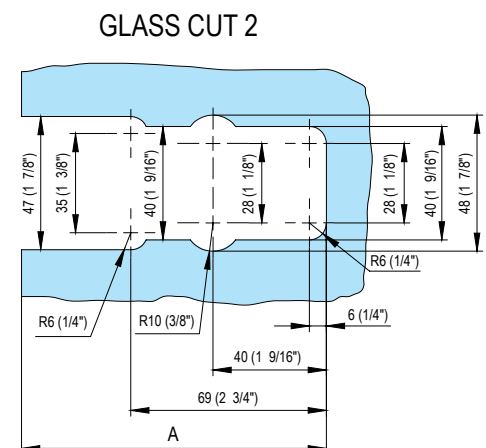
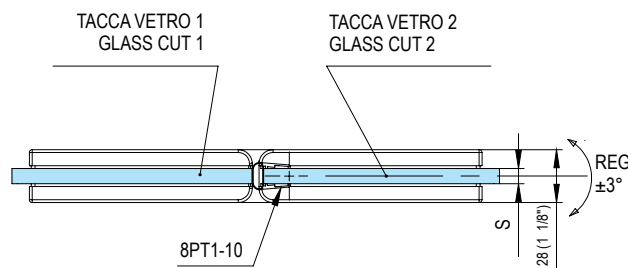
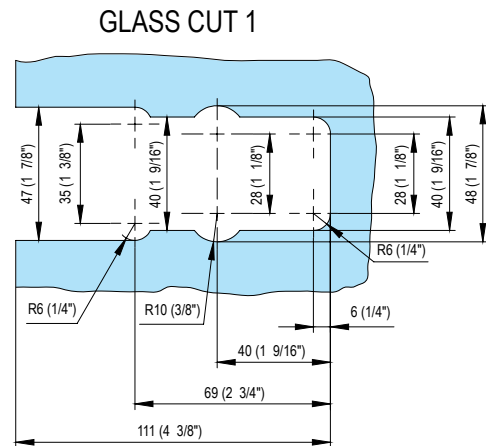
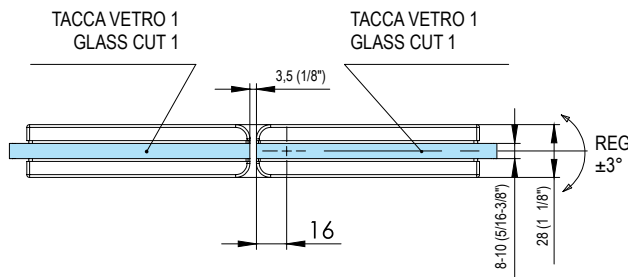

S	A
8 (5/16")	108.5 (4 9/32")
10 (3/8")	106.5 (4 3/16")

cerniera oleodinamica / oildynamic hinge

Biloba **Unica Slim**



106E10

106E20/27



Zama / Zamak - finiture / colors 31-32-60-62

Unica Slim è la nuova cerniera chiudiporta oleodinamica con chiusura automatica.

- Dimensioni ridotte e design essenziale
- La velocità è preimpostata ed è possibile rallentarla
- Applicazioni in ambienti interni
- Regolazione del punto zero
- Regolazione dell'allineamento a filo pavimento della porta
- Copertine di finitura ad aggancio rapido
- Covers realizzate in acciaio inox satinato e lucido

Con un ottimo rapporto qualità prezzo, Unica Slim viene venduta in abbinamento alla cerniera superiore (106E20/27) delle stesse dimensioni. Efficacia tecnica, innovazione e design in un'unica ed esclusiva cerniera chiudiporta.

Unica Slim es la nueva bisagra hidráulica con cierre automático de la puerta.

- La velocidad de cierre es predeterminada, y es posible ralentizarla;
- Dimensiones reducidas y diseño minimalista;
- Apta para aplicaciones interiores;
- Regulación del punto 0°;
- Regulación eje de giro de la puerta;
- Tapas de retoque con enganche rápido;
- Tapas producidas en acero inoxidable satinado o brillo.

Con un excelente relación calidad/precio, Unica Slim se vende en combinación con la bisagra superior de las mismas dimensiones (106E20/27).

Unica Slim is the new oildynamic door closer hinge with automatic closing.

- Reduced dimensions and minimal design;
- Closing speed is pre-set and it is possible to make it slower;
- Suitable for inner applications;
- 0° point regulation;

- Turning point regulation;
- Quick-fixation finishing covers;
- Satin and polished stainless steel covers.

With an excellent quality-price ratio, Unica Slim is sold in combination with the related upper hinge (106E20/27), which has the same dimensions.

Unica Slim ist das neue Band mit integriertem Türschließer mit automatische Schließung.

- Die Schließgeschwindigkeit ist vorbestimmt und kann verlangsamt werden
- Geringe Größe und essenzielles Design
- Anwendung in Innenbereichen
- 0°-Punkt-Regulierung
- Regulierung Axis der Tür
- Kappen mit Schnellkupplung
- Kappen aus Edelstahl - glänzend und satiniert

Mit einem ausgezeichneten Preis-Leistungs-Verhältnis wird Unica Slim in Kombination mit dem oberen Band (106E20/27), der gleichen Abmessungen verkauft. Technische Effizienz, Innovation und Design in einem einzigartigen und exklusiven Türschließer.

Unica Slim, une penture hydraulique avec système de fermeture intégré.

- Vitesse de fermeture prédéterminée et qui peut être ralentie
- Dimensions réduites et design minimaliste
- Application en intérieur possible
- Réglage du point 0°
- Réglage de l'axe de la porte
- Montage rapide des capots
- Capots en inox brossé ou chromé brillant

Avec un excellent rapport qualité-prix, la Unica Slim est vendue avec une penture supérieure (106E20/27) de même dimension. Efficacité technique, innovation et design réunis dans une charnière unique et exclusive.





106E10

Biloba
Unica SLIM
oildynamic hinge

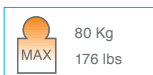
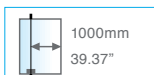
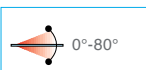

• Cerniera oleodinamica con chiusura automatica a velocità preimpostata, non modificabile. Stop a 0° +90° -90°. Abbinandola con cerniera superiore dedicata, è possibile ridurre la velocità di chiusura di pochi secondi.

• Bisagra hidráulica con cierre automático con velocidad de cierre predeterminada, no modificable. Cerrojo a 0° +90° -90°. También apta para puertas con tope. Combinando la bisagra con la bisagra superior dedicada, es posible reducir la velocidad de cierre de unos segundos.

• Hydraulic hinge with predetermined, non-modifiable automatic closing. Stop at 0° +90° -90°. Suitable for doors with a stop as well. Combining the lower hinge with the upper one allows the reduction of closing speed of some seconds.

• Hydraulikschamier mit Feststellung der Türschließgeschwindigkeit und voreingestellte Geschwindigkeit. Stop at 0° +90° -90°. In Kombination mit dem oberen Band 106E20/27, es ist möglich, die Türschließgeschwindigkeit, um einige Sekunden zu reduzieren.

• Charnière hydraulique avec système de fermeture intégré et vitesse pré réglée, non modifiable. Arrêt à 0°, +90° et -90°. Avec la charnière supérieure 106E20/27, il est possible de réduire la vitesse de fermeture en quelques secondes.

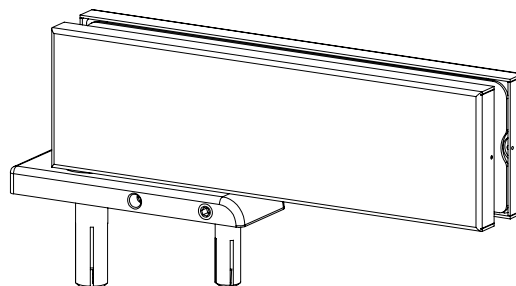

DA ABBINARE SOLO A SERRATURE MAGNETICHE • SOLO SE PUEDE COMBINAR CON CERRADURAS MAGNETICAS • TO BE COMBINED WITH MAGNETIC LOCKS ONLY
KANN NUR MIT MAGNETSCHLÖSSERN KOMBINIERT WERDEN • COMBINABLE UNIQUEMENT AVEC DES SERRURES MAGNÉTIQUES

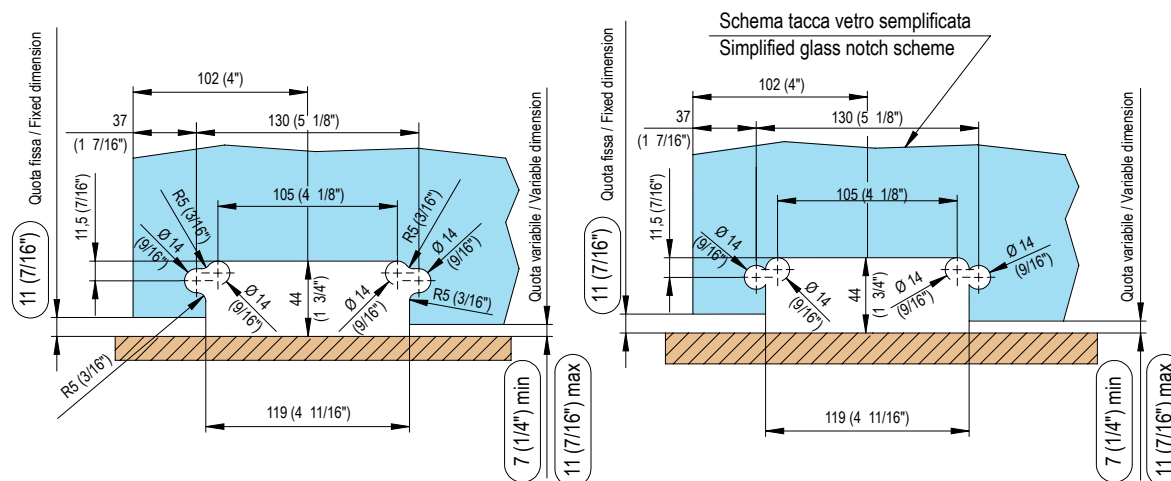
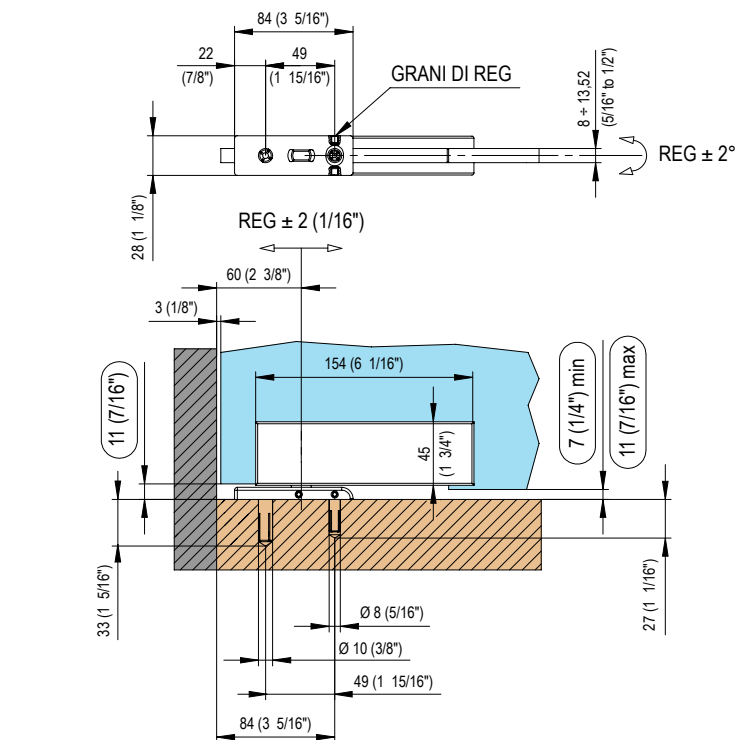

106E20/27

Biloba
Unica SLIM

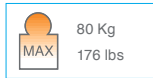
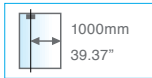

- Cerniera superiore con piletta e dispositivo frenante integrato. Da abbinare con cerniera inferiore art.106E10.
- Bisagra superior con punto de giro y dispositivo de freno integrado. Utilizar en combinación con la bisagra inferior, art. 106E10.
- Upper hinge with pivot and integrated braking system. To be used in combination with lower hinge art. 106E10.
- Oberes Band mit Zapfen und integriertem Bremsmechanismus. In Kombination mit dem unterem Band art. 106E10.
- Charnière supérieure avec axe et système de fermeture intégré. A utiliser en association avec la charnière inférieure art.106E10.

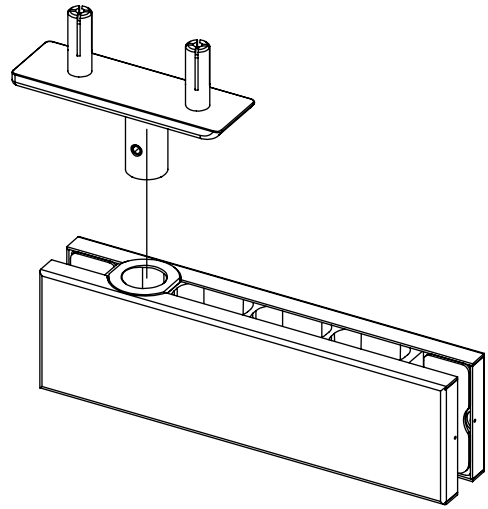

DA ABBINARE SOLO A SERRATURE MAGNETICHE • SOLO SE PUEDE COMBINAR CON CERRADURAS MAGNÉTICAS • TO BE COMBINED WITH MAGNETIC LOCKS ONLY
KANN NUR MIT MAGNETSCHLÖSSERN KOMBINIERT WERDEN • COMBINABLE UNIQUEMENT AVEC DES SERRURES MAGNÉTIQUES

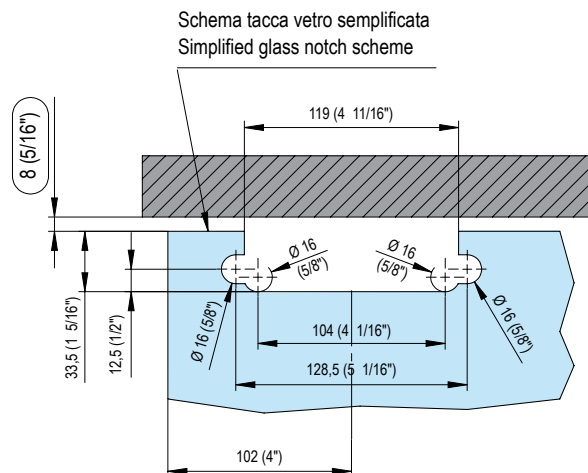
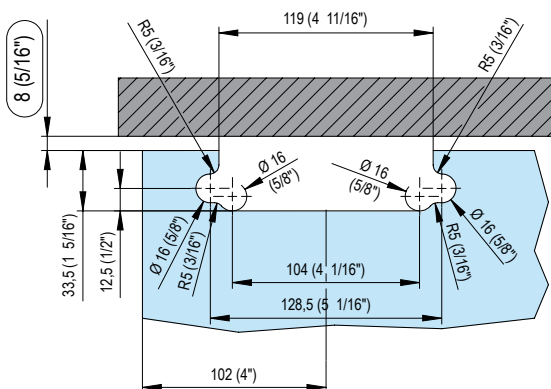
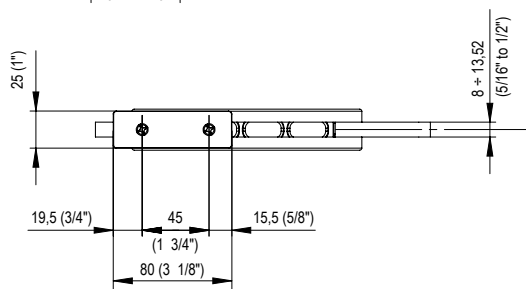
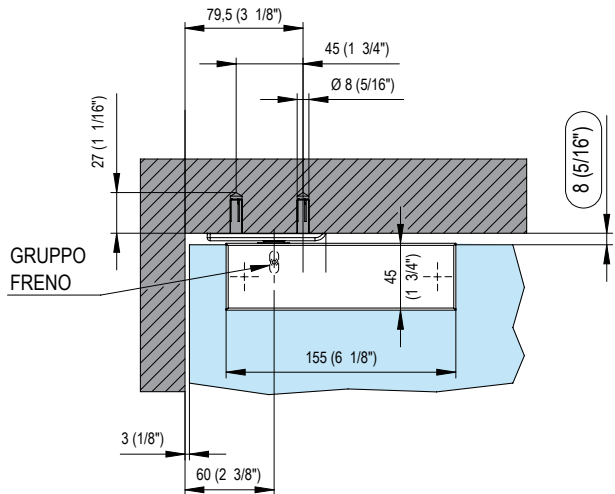

cerniere / hinges

Biloba Unica NF



101E10NF



Alluminio / Aluminium - finiture / colors 02-05-14-15-16-17-31-32-60-62

La serie Biloba Unica è disponibile nella versione NF senza freno integrato per porte interne. Cerniere che coniugano sempre una elevata qualità tecnica, la sicurezza del movimento ed il design minimale. Biloba UNICA è abbinabile a tutti i patch fittings esistenti sul mercato ed alla cerniera superiore serie Maxima. Biloba Unica prevede cerniere superiori con le stesse dimensioni e design, sia con attacco a muro che per sopraluce (art.100E20 e art.100E 25).

La serie "Biloba Única" está disponible en la versión NF sin freno, para puertas interiores. Esas bisagras combinan una alta calidad técnica, seguridad y un diseño minimalista. La bisagra "Biloba Unica" puede ser compatible con todos los "patch fittings" que existen en el mercado y también con la bisagra superior de la serie Maxima. La bisagra "Biloba Unica" se prevehe en modelos diferentes pero con el mismo tamaño y diseño, tanto para la sujeción a la pared cuanto para la sujeción a la luna. (art.100E20 e art.100E25).

The series Biloba Unica is also available in the version NF, without integrated braking system, for inner doors. These hinges combine a high technical quality and minimal design. Biloba UNICA matches to every type of patch fitting existing on the market and to the top hinge of Maxima series. For those



100E20



A100E40 + 100E25

Alluminio / Aluminium - finiture / colors 02-05-14-15-16-17-31-32-60-62

who are most demanding, Biloba UNICA may have top hinges with same dimensions and design, both with wall and transom mounting (item 100E 20 and item 100E 25).

Die Serie Biloba Unica ist also in Version NF verfügbar: diese Version hat keine Bremse, für Innentüren. Die Bänder vereinen höchste technische Qualität, Bewegungssicherheit mit minimalistischem Design. Biloba UNICA ist zu allen Arten von Patch Fitting auf der Markt und zum oberen Beschlag Serie Maxima kombinierbar. Für die anspruchsvollsten sieht Biloba Unica zwei oberen Beschläge mit selben Maßen und Design vor; sowohl mit Wandmontage als auch Montage am Oberlichtfenster (Art.100E20 und Art.100E25).

La série Biloba Unica est également disponible dans la version NF, sans système de frein intégré, pour portes intérieures. Ces charnières combinent haute performance technique, sécurité des mouvements et design minimaliste. Biloba UNICA peut être associée à toute penture et charnière existante sur le marché et aux charnières supérieures de la série Maxima. La série Biloba Unica prévoit des charnières supérieures de dimensions et design similaires, pouvant être installées sur mur ou sur imposte: 100E20 et 100E25.



101E10NF

Biloba Unica

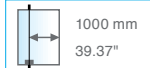
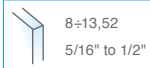

- Cerniera oleodinamica **senza freno**, integrata di regolazioni della velocità di chiusura e dello scatto finale dell'anta. Abbinabile anche con tutti i patch fittings della serie Maxima. Utilizzabile anche per applicazioni pivotanti. Stop a 0° +90° -90°.
- Bisagra automática hidráulica **sin freno**, integrada ajuste de velocidad de cierre y de disparo final de la puerta. Combinable con todos los herrajes producidos de Maxima serie. Utilizable también en aplicaciones con "punto de giro". Stop a 0° +90° -90°.
- Hydraulic hinge **without brake** but with closing speed & final latch adjustments. Can be combined with all patch fittings of the Maxima series. Useful also for pivoting applications. Stop at 0° +90° -90°.
- Hydraulikband **ohne Bremse** jedoch mit Regulierung der Schließgeschwindigkeit des Endschwunges und der Nulllage. Passend zu allen Produkten der Maxima-Serie. Auch für versetzen Einbau geeignet. Feststellung bei 0° +90° -90°.
- Charnière hydraulique **sans frein**, avec régulation de la vitesse de fermeture et de verrouillage. Egalement compatible avec toutes les charnières et pentures de la série Maxima. Utilisable pour application pivotante. Arrêt à 0°, +90° et -90°.

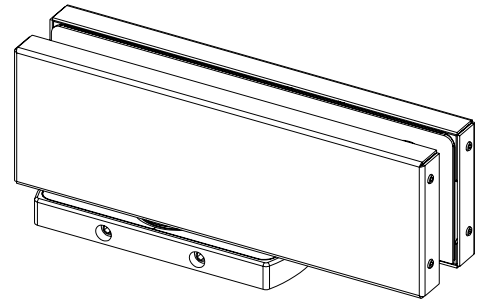

*

L'automatismo di chiusura inizia a operare entro un range compreso tra 70° e 80°. La chiusura è soft per i primi 20°, e regolabile con controllo dai 60° fino a chiusura completa - El automatismo de cierre, comienza a funcionar dentro de un rango entre 70° y 80°. El cierre es suave para los primeros 20° y ajustable con control, de 60° hasta el cierre completo - The closing automatism kicks in within 70°-80° range. The closing is soft for the first 20° and becomes speed-adjustable from 60° up to complete closing. - Die automatische Schließvorrichtung aktiviert sich zwischen 70° und 80°. Die Schließung ist weich für die ersten 20° und justierbar mit Kontrolle ab 60° und bis Komplettschließung - LL' automatisme de fermeture s'enclenche dans une amplitude comprise entre 70° et 80°. La fermeture est lente pour les premiers 20°, et réglable avec contrôle dès 60° et jusqu'à la fermeture complète

DISPONIBILE ANCHE NELLA VERSIONE "L" LIGHT CON MOLLA DEPOTENZIATA PER PORTE DI LARGHEZZA INFERIORE A 600 MM. Versione da specificare in fase d'ordine e soggetta a possibili minimi d'ordine. Per ulteriori informazioni contattare l'ufficio commerciale. - TAMBÉN DISPONIBLE "L" LIGHT - MUELLE CON MENOS FUERZA PARA PUERTAS INFERIORES A 600MM DE ANCHO. Se tendrá que especificar en los pedidos y ser objeto de pedido mínimo. Nuestra oficina comercial está a su disposición para ampliar esta o cualquier otra información. - ALSO AVAILABLE IN "L" LIGHT VERSION WITH POWER-DOWNGRADED SPRING FOR DOORS WITH LESS THAN 600 MM. Both must be specified when ordered and may be subject to a minimum quantity order. For further info, please contact our export dept. - ES IST AUCH IN VERSIONE VERFUGBAR "L" LIGHT MIT SCHWÄCHERER FEDER FÜR TÜREN UNTER 600 MM BREITE. Beide sind bei der bestellung anzugeben und könnten eine mindestbestellmenge verlangen. Für weitere informationen setzen sie sich mit unserer exportabteilung im kontakt. - EGALEMENT DISPONIBLE EN VERSION "L" LIGHT AVEC UNE FORCE RÉDUITE POUR LES PORTES DE LARGEUR INFÉRIEURE A 600 MM. Versions à préciser lors de la commande

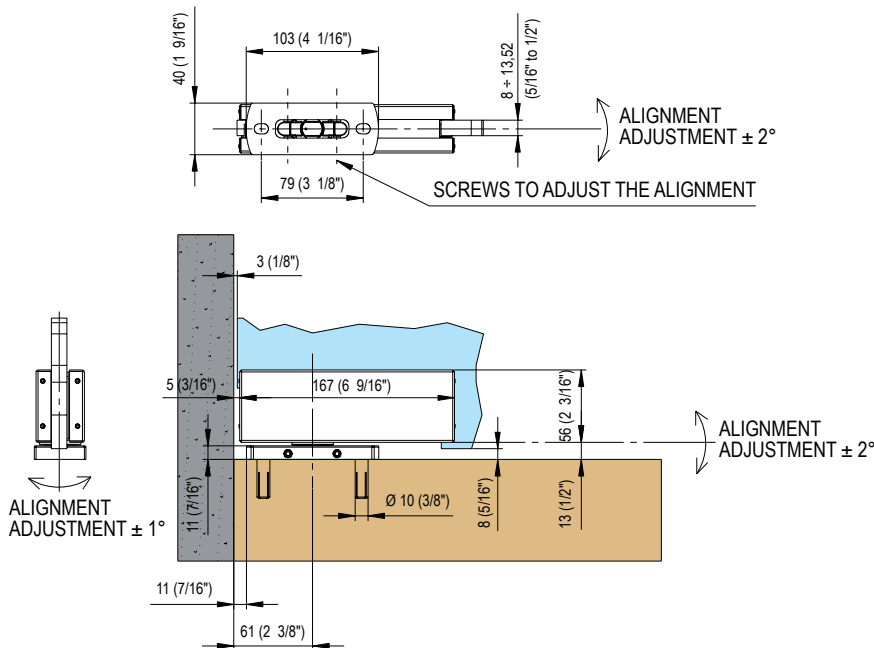

Lavorazione vetro per applicazione pivotante - Labrado del vidrio en aplicación con "punto de giro" - Glass processing for pivoting applications - Glasbearbeitung für schwenkende Installation - Transformation du verre pour application pivotante

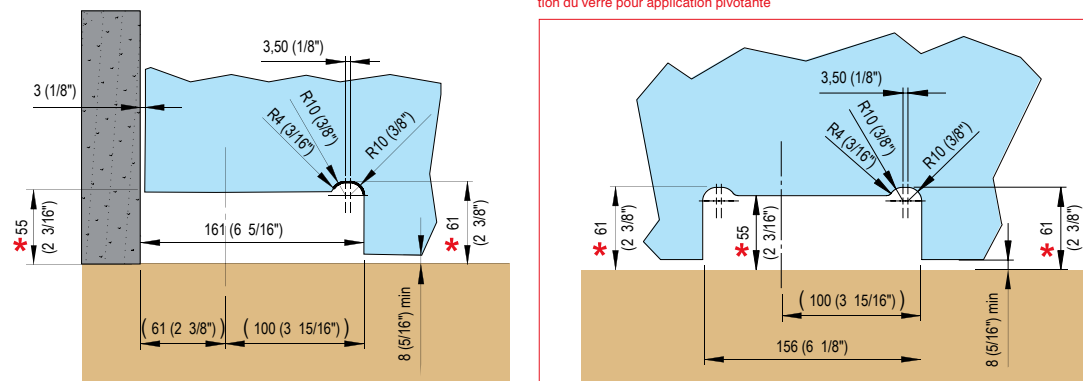

* DISTANZA DA TERRA - DISTANCIA DESDE EL SUELO - DISTANCE FROM THE FLOOR - ABSTAND VOM BODEN - DISTANCE AU SOL

100E20

Biloba Unica

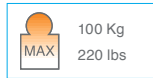
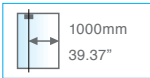

- Cerniera superiore.
- Bisagra superior.
- Top hinge.
- Oberes Band.
- Charnière supérieure.

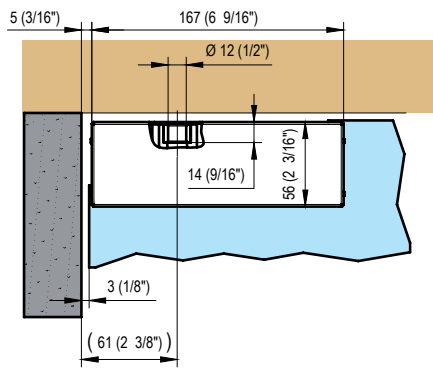
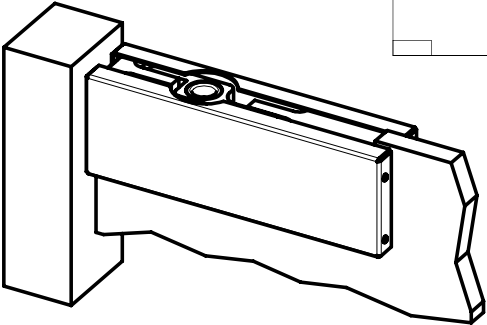
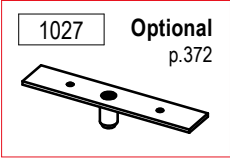
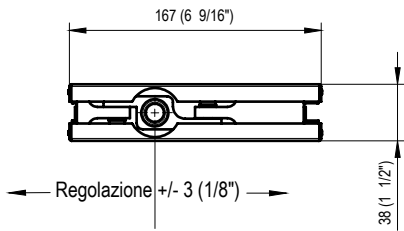
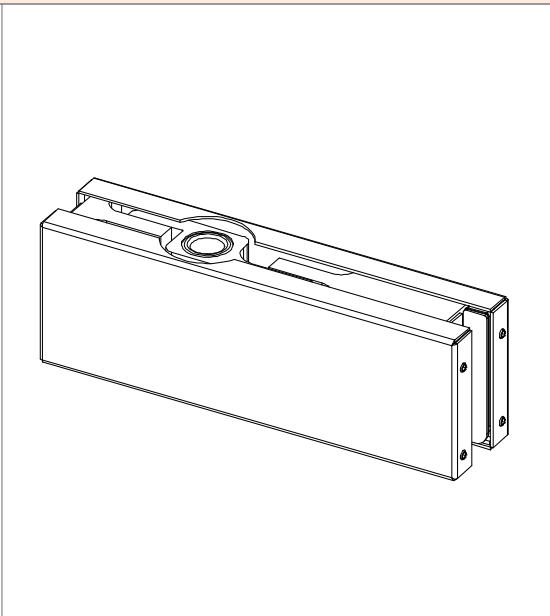

Lavorazione vetro per applicazione pivotante - Labrado del vidrio en aplicación con "punto de giro" - Glass processing for pivoting applications - Glasbearbeitung für schwenkende Installation Transformation du verre pour application pivotante

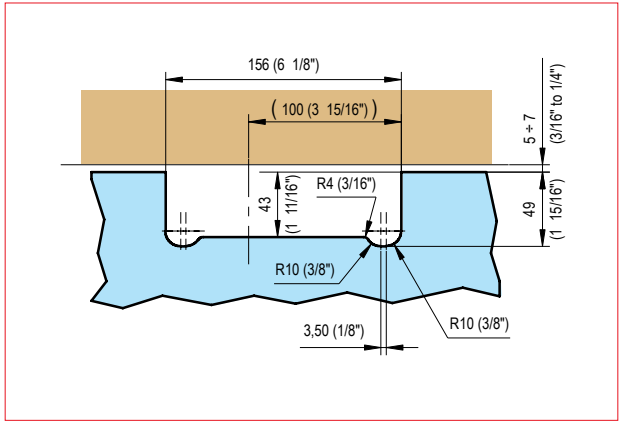
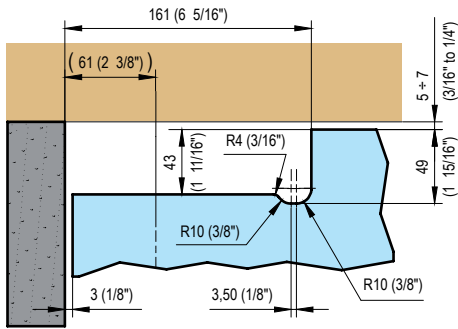

100E25

Biloba Unica

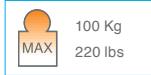
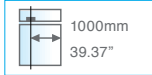

- Attacco sopraluce per art.100E20.
- Enganche de giro montante para art.100E20.
- Transom link fitting for item 100E20.
- Kupplung für Oberlichtfenster für art.100E20.
- Imposte art.100E 20.

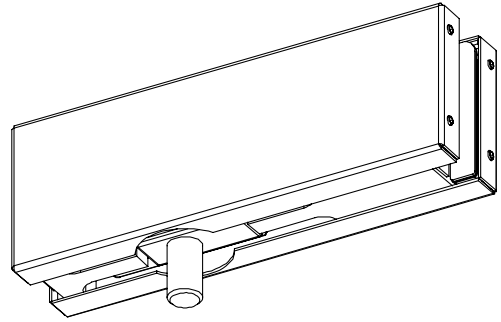

A100E40

Biloba Unica

- Piastrina per attacco a muro per art.100E25.
- Accesorio para la fijación a pared para art.100E25.
- Wall fixing accessory for item 100E25.
- Zubehör für Wandfixierung für Art.100E25.
- Plaque pour montage mural art.100E25.

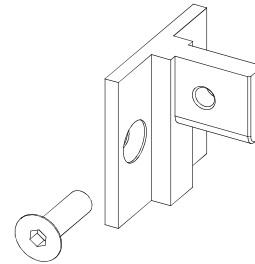

APPLICAZIONE - APLICACIÓN - APPLICATION - ANWENDUNG - APPLICATION

100E25

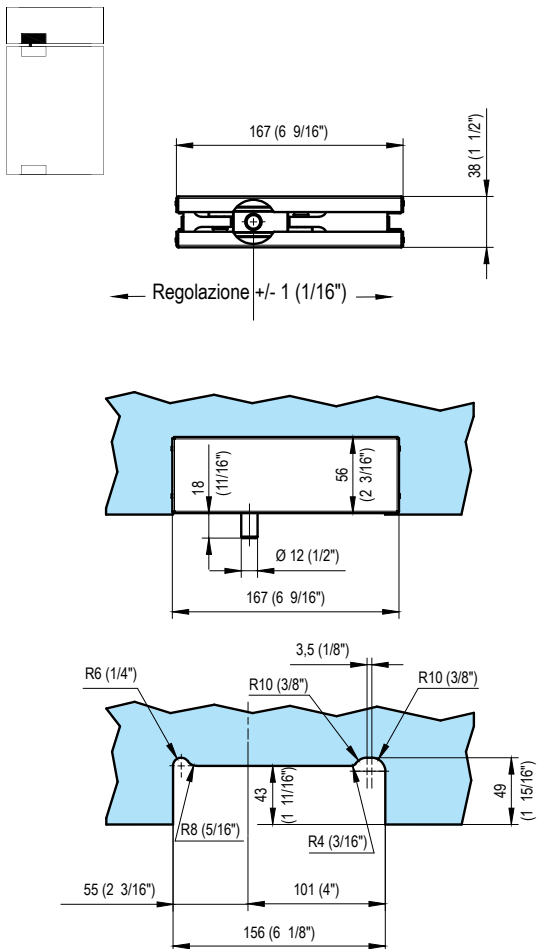

APPLICAZIONE - APLICACIÓN - APPLICATION - ANWENDUNG - APPLICATION

100E25 + A100E40

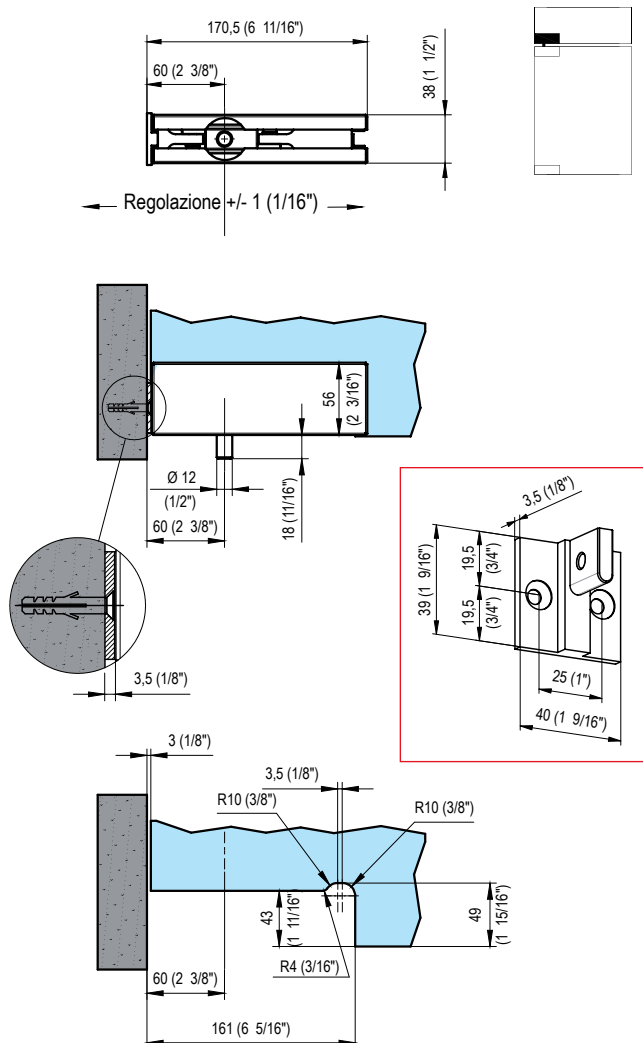

cerniere automatiche / automatic hinges

serie Collio



8680



8681



Alluminio / Aluminium - finiture / colors 02-05-13-14-15-16-17-22-60-62

COLLIO è la nuova cerniera per porte a peso ridotto completa di ammortizzatore a polimero e sistema di chiusura automatica. Nasce per porte intelaiate e partizioni ed è perfettamente compatibile con il profilo P35E. COLLIO è l'evoluzione della cerniera 8610; la prima cerniera automatica conosciuta dal mercato. Uno dei nostri bestsellers. Abbinabile a serrature magnetiche. Adatto per applicazioni in ambienti bagno e box doccia.

COLLIO es la nueva bisagra para puertas con peso reducido, completa de amortiguador a polímero y sistema de cierre automático. Fue ideada para puertas con marco y en particiones y es perfectamente compatible con los perfiles P35E. COLLIO es la evolución de nuestra bisagra 8610, la primera bisagra automática en el mercado y una de las más vendidas. Se puede combinar con cerraduras magnéticas. Adecuado para aplicaciones en baños y mamparas de ducha.

COLLIO is the new hinge for lightweight doors, featuring polymer-activated damper and automatic closing system. It is conceived for framed doors and partitioning and is perfectly compatible with P35E profiles. COLLIO is the evolution of our hinge 8610, the first-ever automatic hin-

ge on the market and one of our bestsellers. Can be combined with magnetic locks. Suitable for applications in bathrooms and shower enclosures

COLLIO ist das neue Scharnier für leichte Türen mit Polymer-Stoßdämpfer und automatischem Schließsystem. Es ist für gerahmte Türen und Trennwändekonzipiert, und ist perfekt kompatibel mit dem P35E-Profil. COLLIO ist die Weiterentwicklung unseres Scharniers 8610, des ersten automatischen Scharniers auf dem Markt und eines unserer Bestseller. Kann mit Magnetschlössern kombiniert werden. Geeignet für Anwendungen in Badezimmern und Duschtrennungen.

COLLIO est la nouvelle charnière pour portes légères, avec amortisseur en polymère et système de fermeture automatique. Il est conçu pour les portes à cadre et les cloisons et est parfaitement compatible avec le profil P35E. COLLIO est l'évolution de notre charnière 8610, la toute première charnière automatique du marché et l'une de nos meilleures ventes. Peut être combiné avec des serrures magnétiques. Convient pour les applications dans les salles de bains et les cabines de douche.



8680

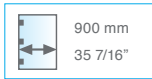
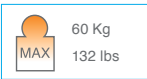
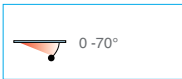
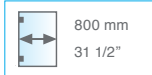
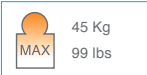
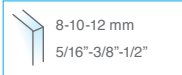

• Cerniera automatica vetro-muro per porte in battuta.

• Bisagra automática vidrio-pared para puertas con tope.

• Automatic hinge glass-wall for doors with stop.

• Automatikscharnier Glas-Wand für Anschlagtüren.

• Charnière automatique verre-mur pour porte à butée.

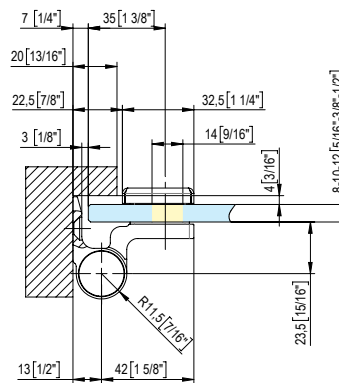
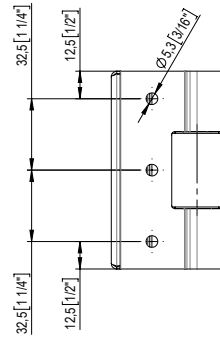
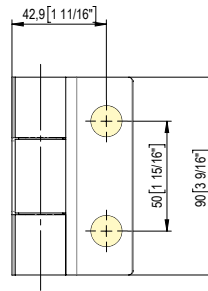
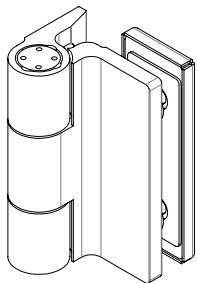

8681

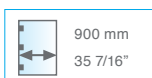
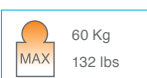
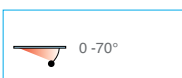
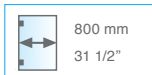
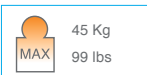
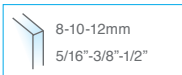

• Cerniera a scatto vetro-vetro 180° per porte in battuta.

• Bisagra con retención vidrio-vidrio 180° para puertas con tope.

• Automatic hinge glass to glass 180° for doors with stop.

• Automatikscharnier Glas-Glas 180° für Anschlagtüren.

• Charnière automatique verre-verre 180° pour porte à butée.

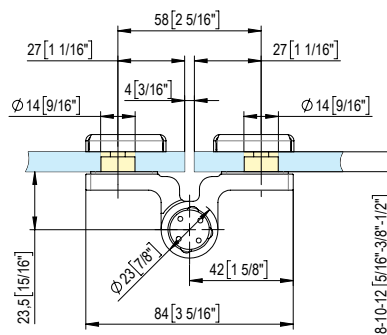
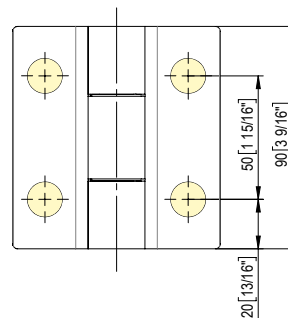
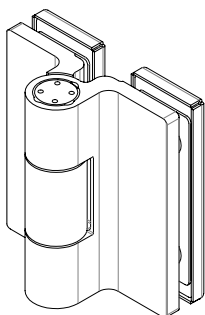

cerniere automatiche / automatic hinges

serie **861 863**



Alluminio / Aluminium - finiture / colors 02-05-13-14-15-16-17-22-60-62

Cerniere automatiche vetro-muro e vetro-vetro che hanno l'automatismo di ritorno in chiusura a partire da 85°. La porta si chiude in maniera rapida e sicura. Sono realizzate in varie finiture e modelli, per dare possibilità di personalizzare le porte in vetro con accessori di qualità e dal design esclusivo, destinate a durare nel tempo. La serie 863 è stata testata e garantita per 500.000 cicli.

Bisagras con retención vidrio/pared y vidrio/vidrio. El automatismo en cierre es activo desde 85°. La puerta se cierra de manera rápida y segura. Producidas en varias versiones y acabados, dan la posibilidad de personalizar las puertas de cristal con accesorios de alta calidad y diseño exclusivo, hechas para durar a lo largo del tiempo. La serie 863 es garantizada para 500.000 ciclos.

Glass/glass or wall/glass clicking hinges, which feature closing movement starting from 85°. The door closes quickly and safely. They are

made in different versions and finishes, to give the possibility to customise glass doors with high-quality, exclusively-designed accessories, Which are meant to last long. Series 863 is tested and guaranteed for 500.000 cycles.

Automatikbänder Glas-Wand- und Glas-Glas mit Automatik patentierte Schließvorrichtung sind in verschiedenen Oberfläche und Modellen verfügbar um geben die Möglichkeit, Glastüren mit Qualitätszubehör e aus exklusivem Design, bestimmt für die Ewigkeit. Die 863-Serie war getestet und garantiert für 500.000 Zyklen.

Charnières automatiques verre-mur et verre-verre dotées d'un automatisme de retour breveté, elles sont disponibles dans des finitions et modèles diverses pour permettre de personnaliser les portes en verre avec des accessoires design de qualité, uniques et destinés à durer dans le temps.



8609

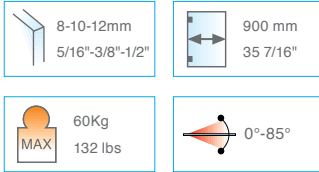

• Cerniera automatica apertura a 0° +90°-90° con aletta spostata.

• Bisagra automática con aleta desplazada: abre a 0° +90°-90°.

• Automatic hinge closing at 0° +90°-90° with offset fixing wing.

• Automatikscharnier 0° +90°-90° zur einseitigen Wandmontage.

• Charnière automatique avec ouverture à 0°, +90° et -90° et pattes de fixation déportées.

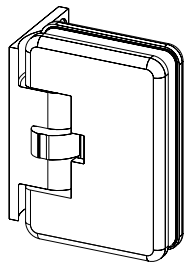

Non adatta per porte con battuta
No adecuada por puertas con tope
Not suitable for doors with stop
Nicht für Anschlagtüren geeignet

Cerniera testata 120.000 cicli. Per l'utilizzo in luoghi di maggior passaggio si consiglia la famiglia 863 e la serie oleodinamica. È sconsigliato l'utilizzo in ambienti umidi.

Bisagra probada en 120.000 aberturas. No está recomendada por su utilización en lugares de paso frecuente. Para utilización de este tipo, se recomienda la serie 863 y la serie hidráulica, así como en ambientes húmedos.

The hinge is tested for 120,000 cycles. For using in main area, we suggest the 863 family and hydraulic series. It is advise against the uses in wet environment.

Für 120.000 Zyklen getestet. Für den Einsatz in höheren besuchten Räumen

wird die Familie 863 und die hydraulische Serie vorgeschlagen. Der Einsatz in Feuchträumen wird abgeraten.

Charnière testée pour 120.000 cycles. Pour une utilisation dans des lieux plus fréquentés, nous recommandons la famille 863 et la série hydraulique. L'utilisation dans un environnement humide est déconseillée.

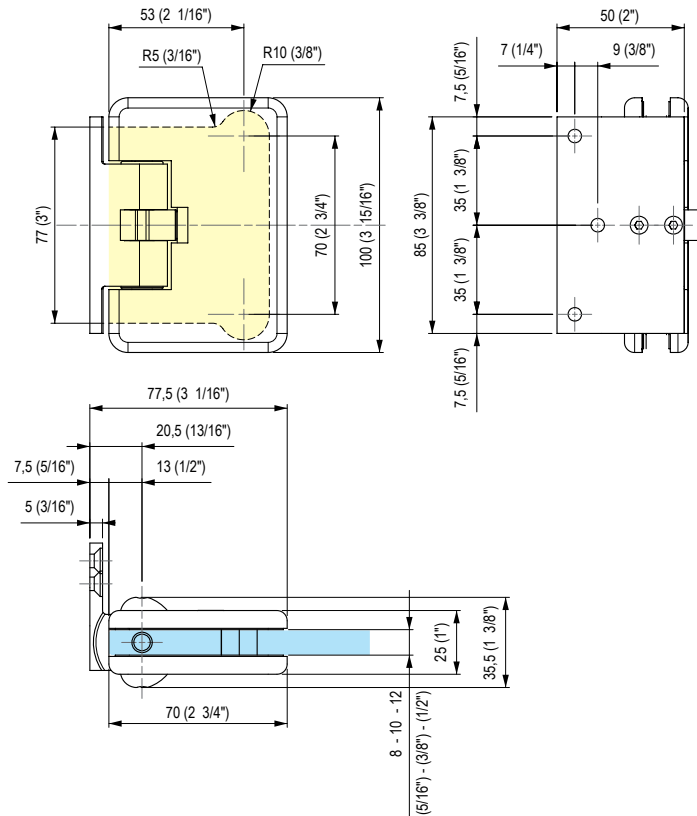

8610

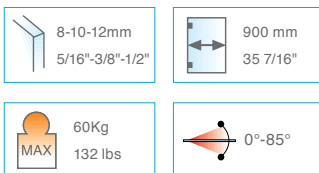

• Cerniera automatica apertura a 0° +90° -90° .

• Bisagra automática: abre a 0° +90° -90°.

• Automatic hinge closing at 0° +90°-90°.

• Automatikscharnier 0° +90° -90°.

• Charnière automatique avec ouverture à 0°, +90° et -90° .

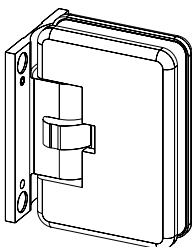

Non adatta per porte con battuta
No adecuada por puertas con tope
Not suitable for doors with stop
Nicht für Anschlagtüren geeignet

Cerniera testata 120.000 cicli. Non è consigliato l'utilizzo in luoghi di frequente passaggio (per utilizzi di questo genere si consiglia l'art.8010 o 8630), nonché in ambienti umidi.

Bisagra probada 120.000 ciclos. No está recomendada su utilización en lugares de paso frecuente (para utilizaciones de este tipo se recomienda el art.8010 o 8630), así como en ambientes húmedos.

Hinge tested to 120,000 cycles. Not recommended for use on high frequency doors (art. 8010 or 8630 are recommended for this type of use) and in humid environments.

Für 120.000 Zyklen getestet. Der Einsatz in stark besuchten Räumen (dafür wird im Allgemeinen der Art. 8610/8630 empfohlen) und in Feuchträumen wird abgeraten.

Charnière testée pour 120.000 cycles. Pour une utilisation dans des lieux plus fréquentés, nous recommandons la référence 8010 ou 8630. L'utilisation dans un environnement humide est déconseillée.

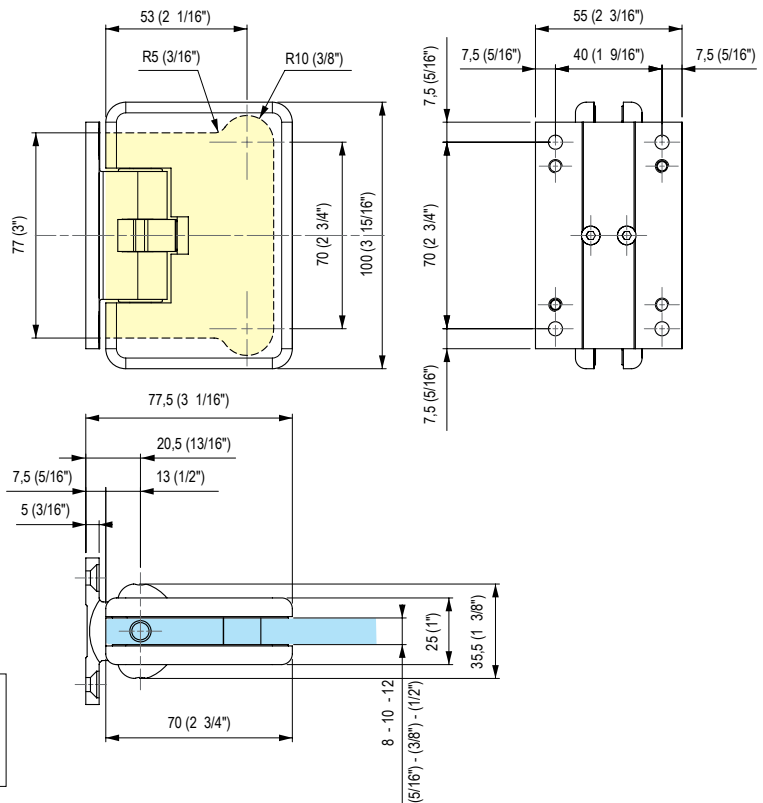

8611

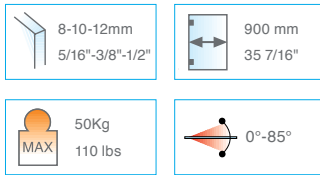

- Cerniera automatica vetro-vetro apertura a 0° +90° -90°.
- Bisagra automática vidrio-vidrio abre a 0° +90° -90°.
- Automatic hinge glass to glass closing at 0° +90° -90°.
- Automatikscharnier Glas-Glas 0° +90° -90°.
- Charnière automatique avec ouverture à 0°, +90° et -90°.

Non adatta per porte con battuta.
No adecuada por puertas con tope.
Not suitable for doors with stop.
Nicht für Anschlagtüren geeignet.

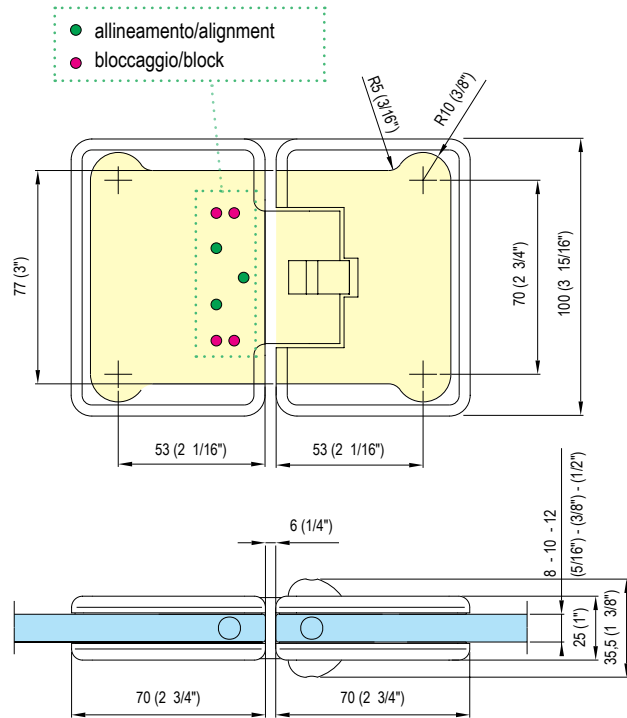
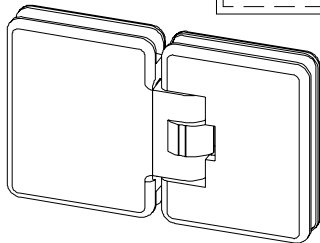

Cerniera testata 120.000 cicli. Non è consigliato l'utilizzo in luoghi di frequente passaggio (per utilizzi di questo genere si consiglia l'art.8015 o 8635), nonché in ambienti umidi.

Bisagra probada 120.000 ciclos. No está recomendada su utilización en lugares de paso frecuente (para utilizaciones de este tipo se recomienda el art.8015 o 8635), así como en ambientes húmedos.

Hinge tested to 120,000 cycles. Not recommended for use on high frequency doors (art. 8015 or 8635 are recommended for this type of use) and in humid environments.

Für 120.000 Zyklen getestet. Der Einsatz in stark besuchten Räumen (dafür wird im Allgemeinen der Art. 8015/8635 empfohlen) und in Feuchträumen wird abgeraten.

Charnière testée pour 120.000 cycles. Pour une utilisation dans des lieux plus fréquentés, nous recommandons la référence 8015 ou 8635. L'utilisation dans un environnement humide est déconseillée.

8630

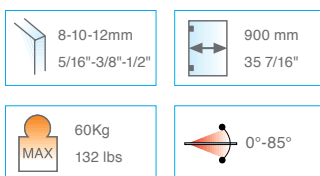

- Cerniera automatica apertura a 0° +90° -90°. Testata 500.000 cicli.
- Bisagra automática: abre a 0° +90° -90°. Probada en 500.000 aberturas.
- Automatic hinge closing at 0° +90° -90°. Tested for 500.000 cycles.
- Automatikscharnier 0° +90° -90°. Für 500.000 Zyklen getestet.
- Charnière automatique avec ouverture à 0°, +90° et -90°. Testée pour 500.000 cycles.

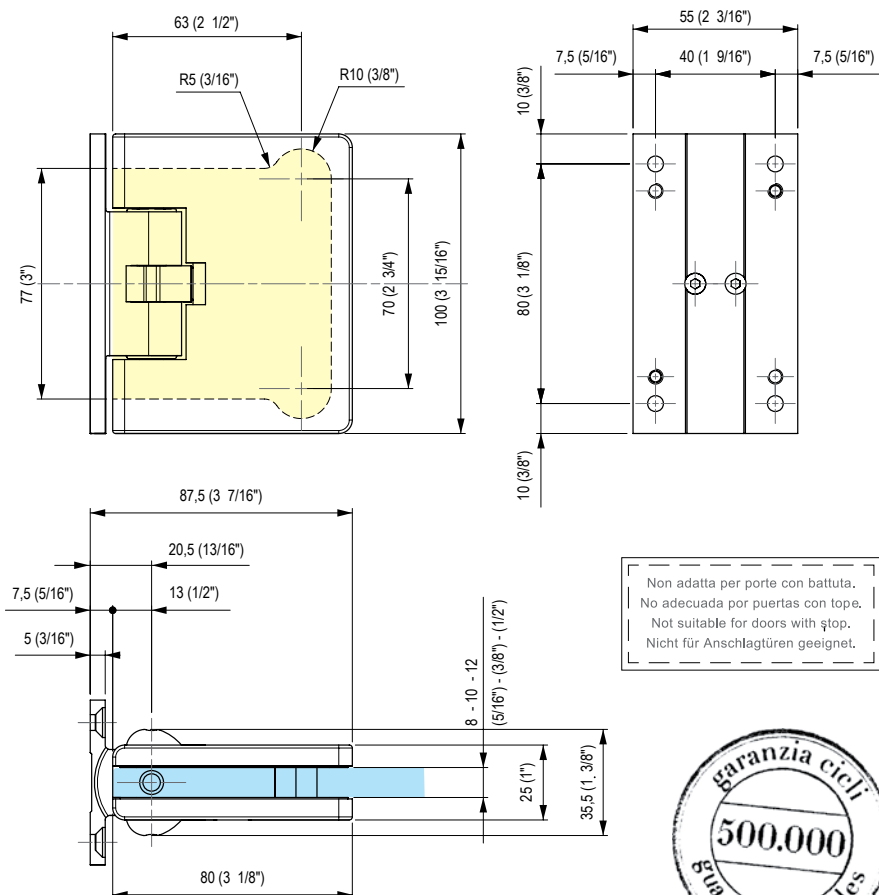
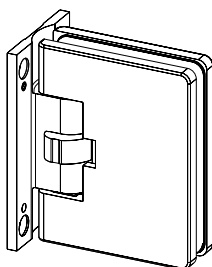

Non adatta per porte con battuta.
No adecuada por puertas con tope.
Not suitable for doors with stop.
Nicht für Anschlagtüren geeignet.



8631

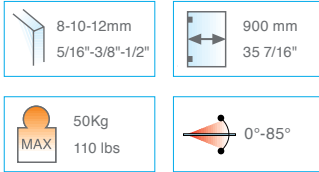

- Cerniera automatica apertura a 0° +90° -90° con aletta spostata. Testata 500.000 cicli.
- Bisagra automática: abre a 0° +90° -90° con aleta desplazada. Probada en 500.000 aberturas.
- Automatic hinge closing at 0° +90° -90° with offset fixing wing. Tested for 500.000 cycles.
- Automatikscharnier 0° +90° -90° zur einseitigen Wandmontage. Für 500.000 Zyklen getestet.
- Charnière automatique verre-mur avec ouverture à 0°, +90° et -90°. Testée pour 500.000 cycles.

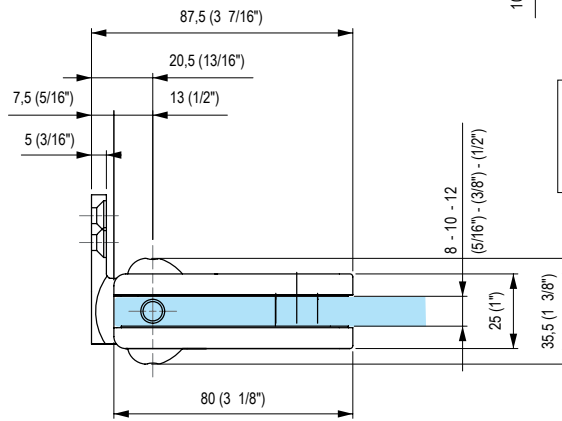
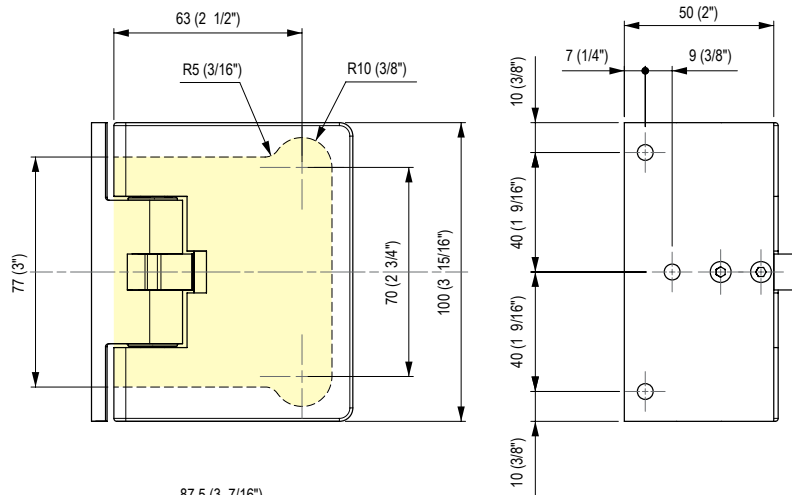
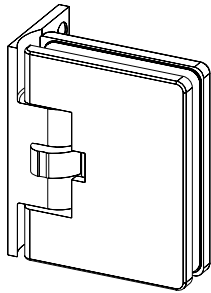

Non adatta per porte con battuta.
No adecuada por puertas con tope.
Not suitable for doors with stop.
Nicht für Anschlagtüren geeignet.



8635

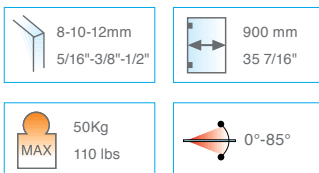

- Cerniera automatica vetro-vetro 180° apertura a 0° +90° -90°. Testata 500.000 cicli.
- Bisagra automática vidrio-vidrio 180°: abre a 0° +90° -90°. Probada en 500.000 aberturas.
- Automatic hinge glass to glass 180° closing at 0° +90° -90°. Tested for 500.000 cycles.
- Automatikscharnier Glas-Glas 0° +90° -90°. Für 500.000 Zyklen getestet.
- Charnière automatique verre-verre 180° avec ouverture à 0°, +90° et -90°. Testée pour 500.000 cycles.

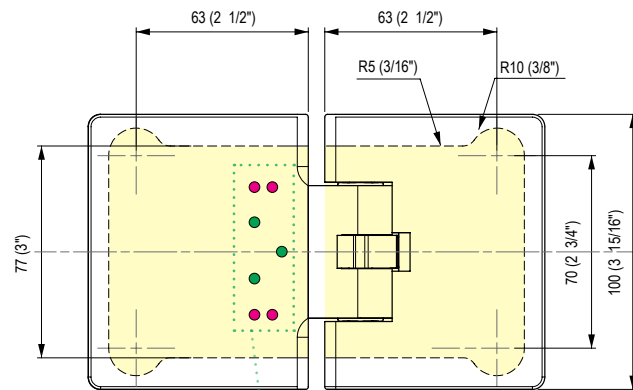
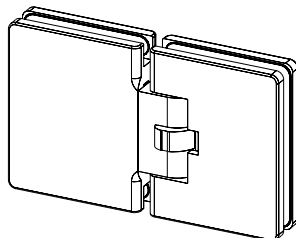

● allineamento/alignment
● bloccaggio/block

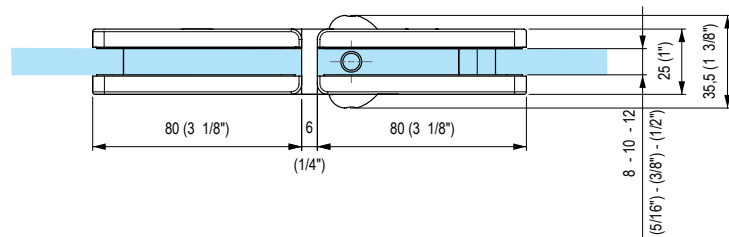

Non adatta per porte con battuta.
No adecuada por puertas con tope.
Not suitable for doors with stop.
Nicht für Anschlagtüren geeignet.



cerniere a scatto / clicking hinges

serie 870



8700



8701



8705 *



Alluminio / Aluminium - finiture / colors 02-05-13-14-15-16-17-22-60-62

Cerniere a scatto per porte in vetro. Disponibili con aletta spostata e nella versione vetro-vetro. Il meccanismo a scatto consente l'arresto della porta in qualsiasi angolazione l'utente desideri lasciare l'apertura a partire da 45°.

Clicking hinges for glass doors, available with offset fixing wing and glass/glass. The clicking mechanism allows the user to stop the door wherever they want starting from 45°.

Clicking hinges for glass doors, available with offset fixing wing and glass/glass. The clicking mechanism allows the user to stop the door wherever they want starting from 45°.

Glastürpendelbänder für Glastüren. Verfügbar mit einseitige Platte und in der Glas-Glas-Version. Der Schnappmechanismus ermöglicht die Einstellung der Tür in alle Winkel möchte der Benutzer die Öffnung verlassen ab 45°.

Charnières à retenue pour portes en verre. Disponibles avec pattes de fixation déportées et dans la version verre-verre. Le mécanisme de retenue permet à l'utilisateur d'arrêter la porte à n'importe quel angle à partir de 45°.



8700

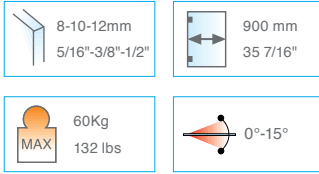

- Cerniera a scatto: apertura a 0° +90° -90°.
- Bisagra con retención: abre a 0° +90° -90°.
- Clicking hinge 0° +90° -90°.
- Glastürpendelband 0° +90° -90°.
- Charnière à retenue avec ouverture à 0°, +90° et -90°.

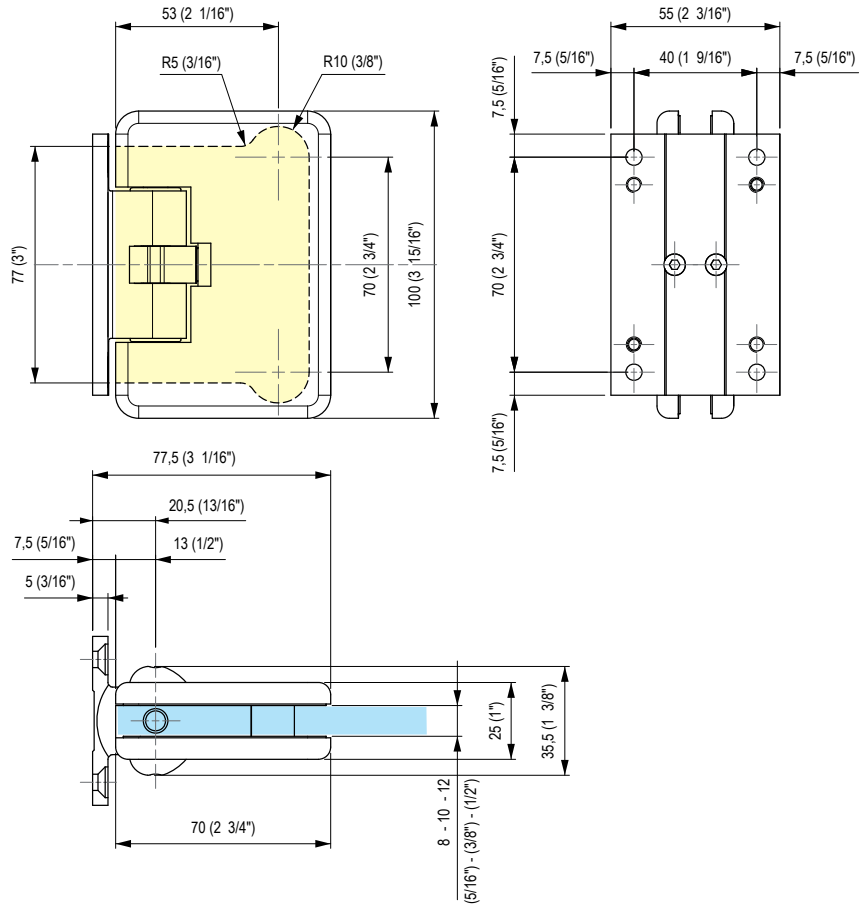
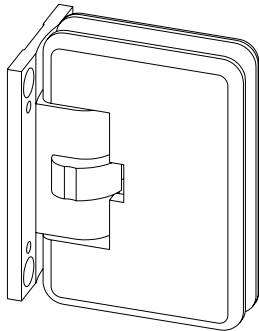

8701

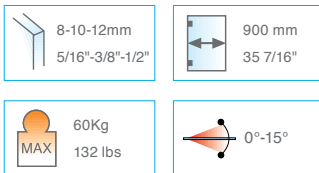

- Cerniera a scatto: apertura a 0° +90° -90° con aletta spostata.
- Bisagra con retención y con aleta desplazada: abre a 0° +90° -90°.
- Clicking hinge 0° +90° -90° with offset fixing wing.
- Glastürpendelband 0° +90° -90° mit einseitiger Montageplatte.
- Charnière à retenue avec ouverture à 0°, +90° et -90° et pattes de fixation déportées.

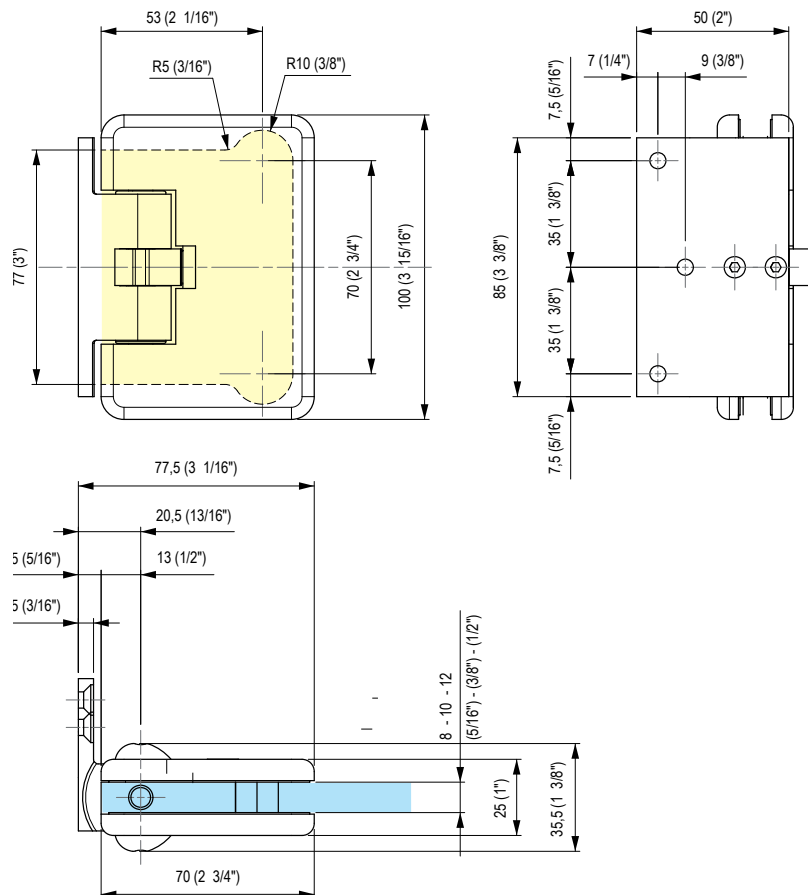
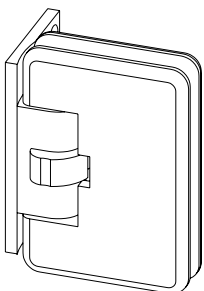

8705

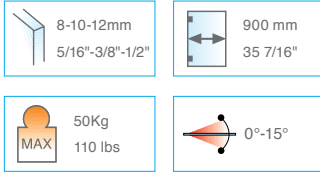

- Cerniera a scatto vetro-vetro 180°. Apertura a 0° +90° -90°.
- Bisagra con retención vidrio-vidrio 180°. Abre a 0° +90° -90°.
- Clicking hinge glass to glass 0° +90° -90°.
- Glastürpendelband Glas-Glas 0° +90° -90°.
- Charnière à retenue verre-verre 180°. Ouverture à 0°, +90° et -90°.

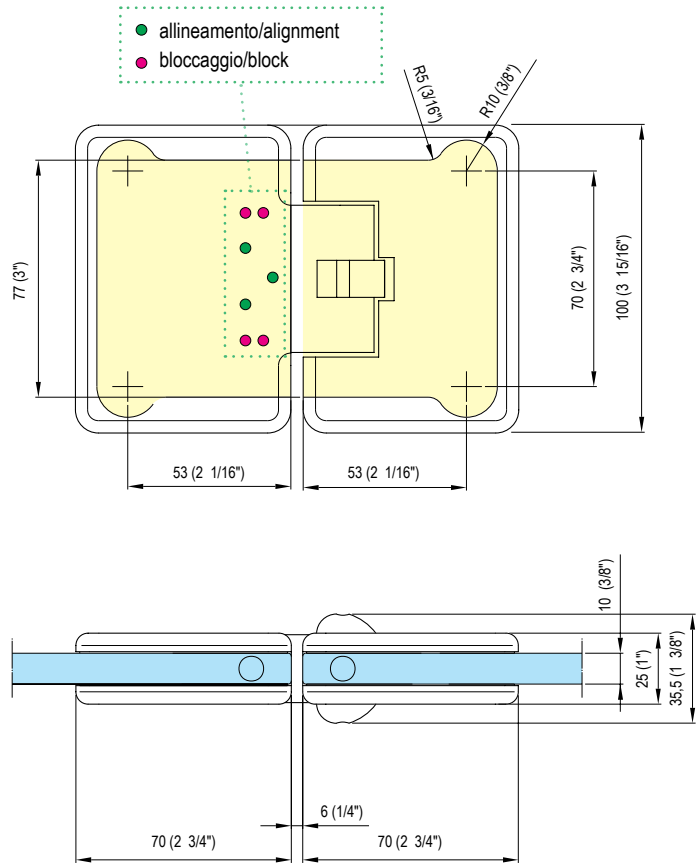
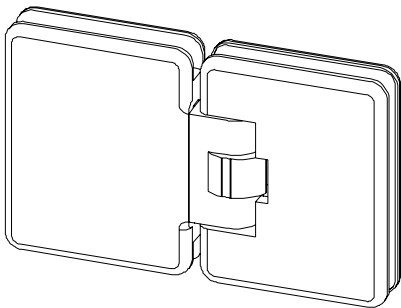

6M10(8-10mm) - 6M12(12mm)



- Fermaporta magnetico h50mm.
- Freno magnético h50mm.
- Magnetic door stopper h50mm.
- Magnet-Türstopper h50mm.
- Ferme-porte magnétique h50mm.

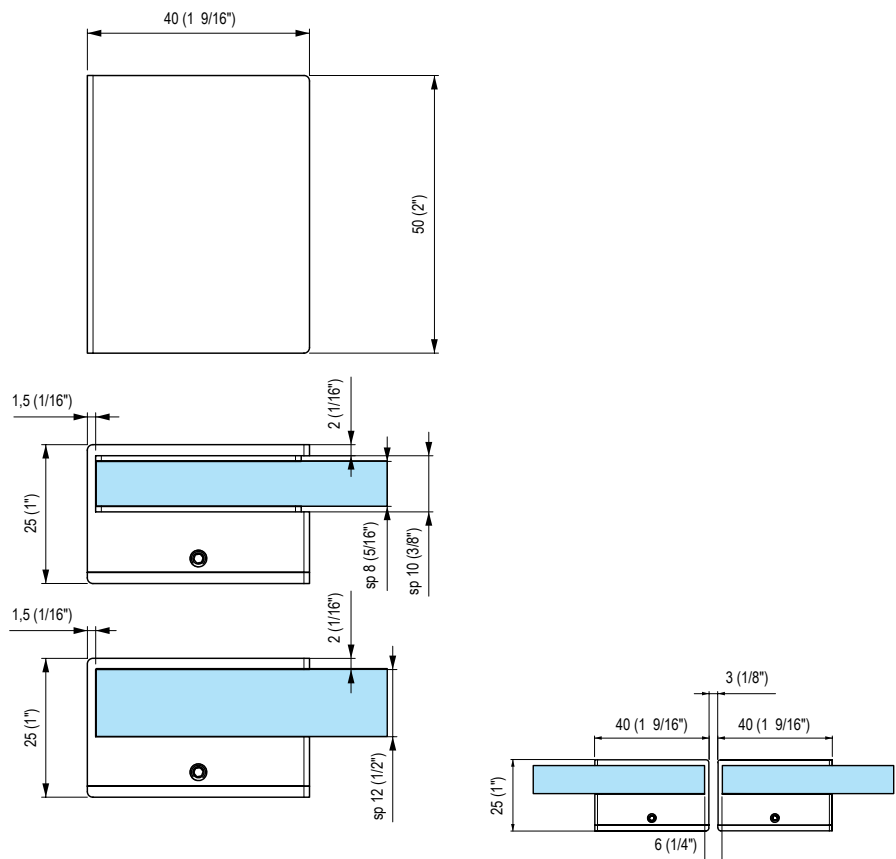
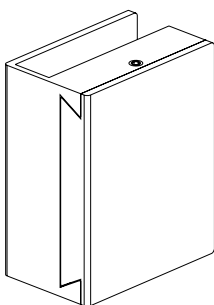

6M15

- Contropiastra magnetica per 6M10/6M12.
- Contra chapa magnética para 6M10/6M12.
- Magnetic plate for 6M10/6M12.
- Magnetische Gegenplatte für 6M10/6M12.
- Plaque magnétique pour 6M10/6M12.

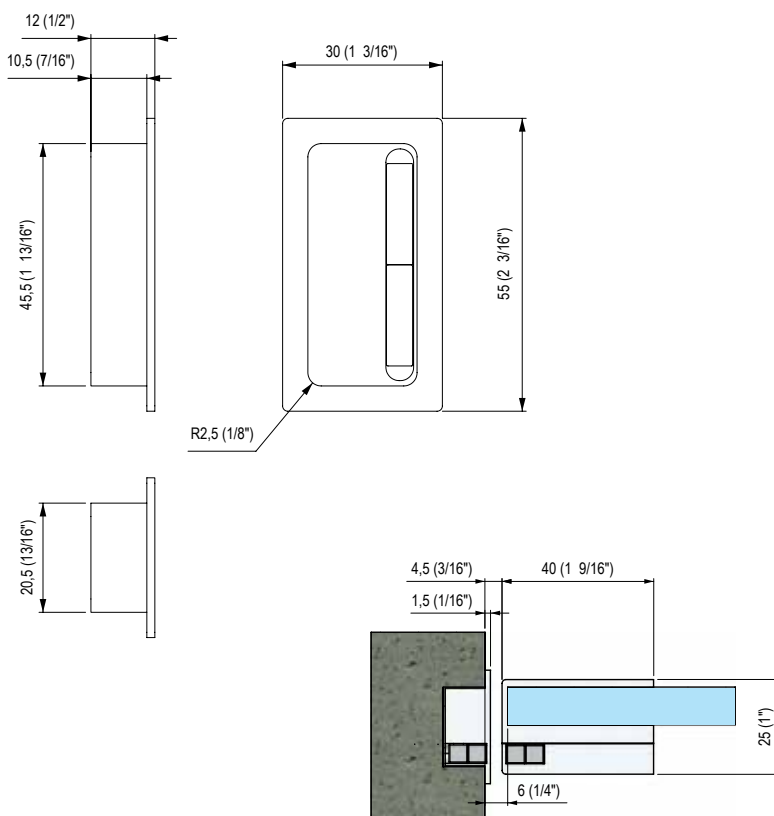
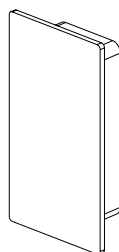

cerniere laterali / side hinges

serie 865 866

finiture / colors 02-05-13-14-15-16-17-60-62

Alluminio / Aluminium



8650

Alluminio / Aluminium



8652

Alluminio / Aluminium



8653

Alluminio / Aluminium



8654

Alluminio / Aluminium



8655

Alluminio / Aluminium



8662

Alluminio / Aluminium



8663

Alluminio / Aluminium



8664

Alluminio / Aluminium



8665

Alluminio / Aluminium



8666

Alluminio / Aluminium



8667

Alluminio / Aluminium



8674

Alluminio / Aluminium



8S10

Alluminio / Aluminium



8S11

no finiture
no colors

Alluminio / Aluminium



8810

Ampia gamma di cerniere laterali con supporto per porte in vetro. Le serie di cerniere laterali consentono l'installazione della porta in vetro direttamente a muro o su telaio in legno. Disponibili in vari modelli e realizzate in diverse finiture consentono di personalizzare al meglio le porte in vetro di casa, uffici e negozi.

Extensa gama de bisagras laterales con soportes para puertas de vidrio. Permiten la instalación de la puerta tanto a pared como a marco de madera. Disponibles en distintos modelos y acabados, permiten la mejor personalización de puertas de vidrio en ámbitos residenciales y comerciales.

Wide range of lateral free hinges for glass doors. These hinges allow the application of the door to wall or to a wooden profile. They are available in different versions and colours, allowing the best customization of residential and commercial doors.

Große Auswahl an Seitenscharnieren mit Glastüren. Die Eine Reihe von Seitenscharnieren ermöglichen den Einbau der Glastür direkt an der Wand oder auf einem Holzrahmen. Erhältlich in verschiedenen Modellen ein verschiedenen Ausführungen gemacht können Sie das Beste anpassen Glastüren von zu Hause, Büros und Geschäften

rge gamme de charnières latérales avec support pour portes en verre. La série de charnières latérales permet l'installation d'une porte en verre directement sur le mur ou sur un cadre en bois. Disponibles en différents modèles et différentes finitions pour une personnalisation unique des portes résidentielles, de bureaux ou de magasins.



8650

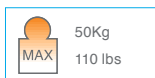

- Cerniera laterale per stipite stretto.
- Bisagra lateral.
- Side hinge for narrow door-jamb.
- Seitliches Scharnier Glas-Wand für schmale Türpfosten.
- Charnière latérale pour jambage étroit.

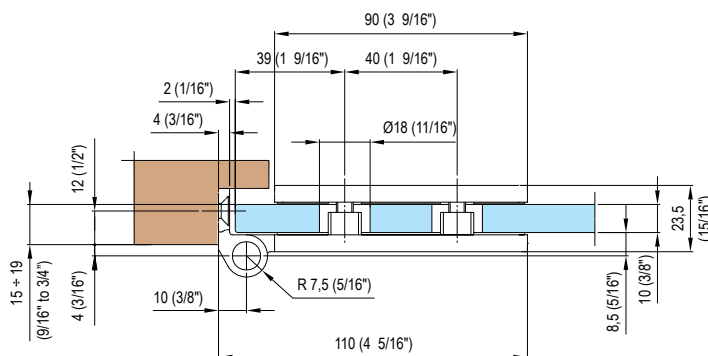
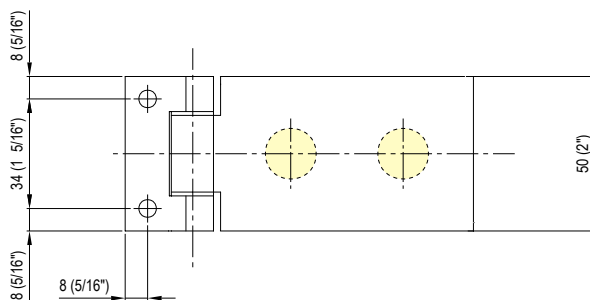
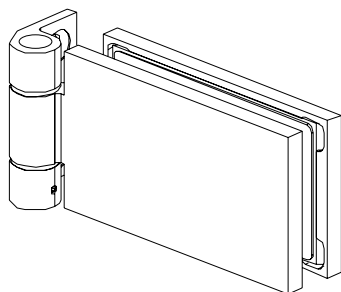

8652

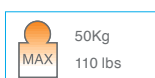

- Cerniera doppia vetro-vetro. 180°.
- Bisagra doble vidrio-vidrio. 180°.
- Double side hinge glass to glass. 180°.
- Doppelscharnier Glas-Glas. 180°.
- Double charnière verre-verre.

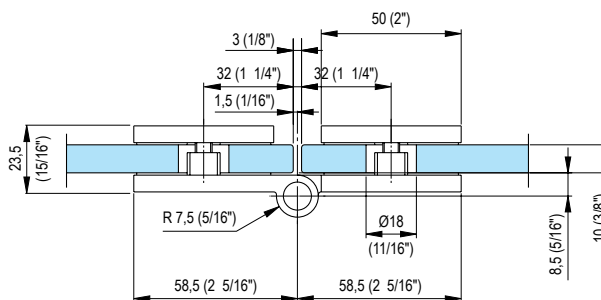
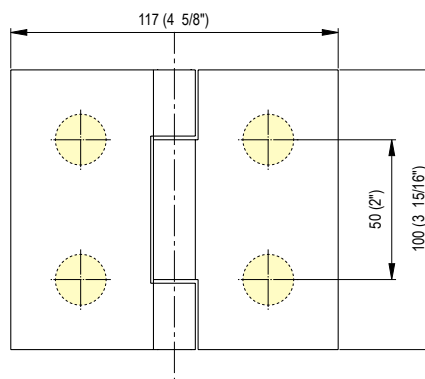
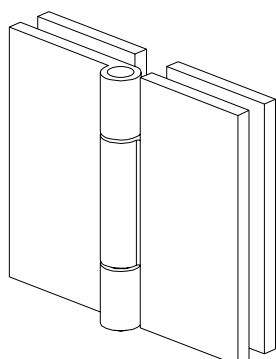

8653

8-10-12mm
5/16"-3/8"-1/2"

1000 mm
39.37"

60Kg
MAX
132 lbs

- Cerniera laterale per stipite stretto.
- Bisagra lateral.
- Side hinge for narrow door-jambs.
- Seitliches Scharnier für schmale Türpfosten.
- Charnière latérale pour jambage étroit.

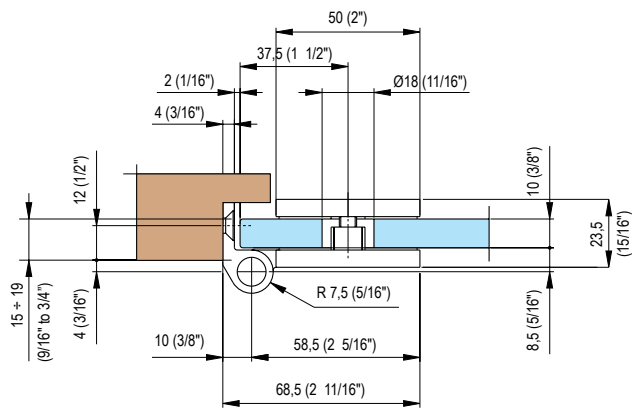
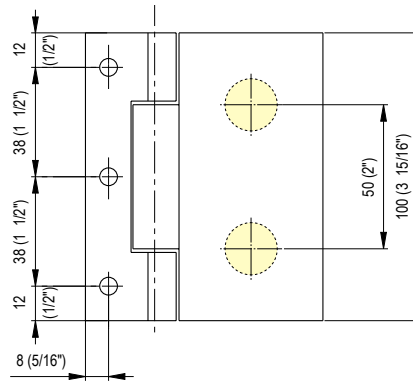
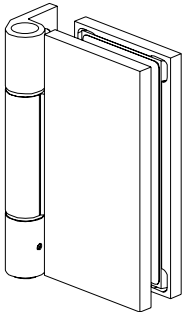

8654

6-8-10mm
5/16"-3/8"

800 mm
31.49"

44Kg
MAX
97 lbs

- Cerniera laterale per stipite stretto.
- Bisagra lateral pequeña.
- Side hinge for narrow door-jambs.
- Seitliches Scharnier für schmale Türpfosten.
- Charnière latérale pour chambranle étroit.

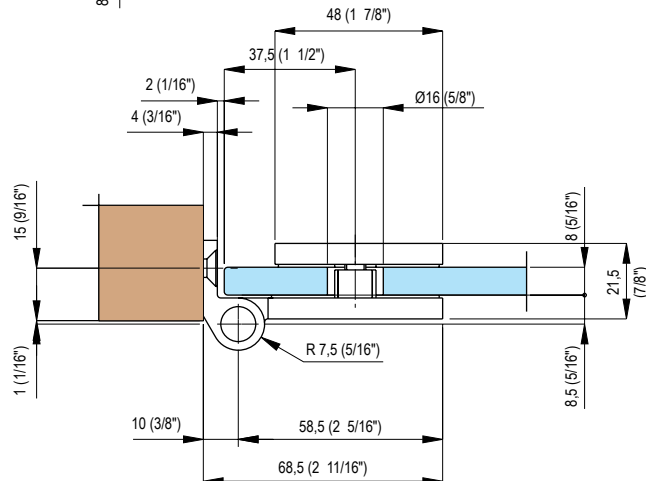
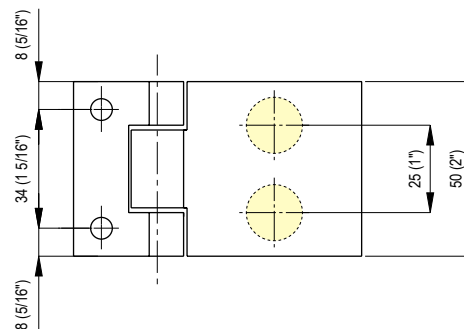
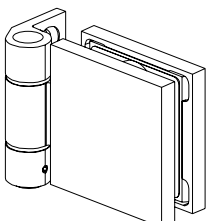

8655

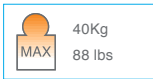
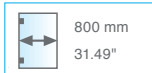
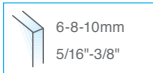

• Cerniera laterale piccola vetro-vetro. 180°.

• Bisagra lateral pequeña vidrio-vidrio. 180°.

• Small side hinge glass to glass. 180°.

• Kleines, seitliches Scharnier Glas-Glas. 180°.

• Petite charnière latérale verre-verre 180°.

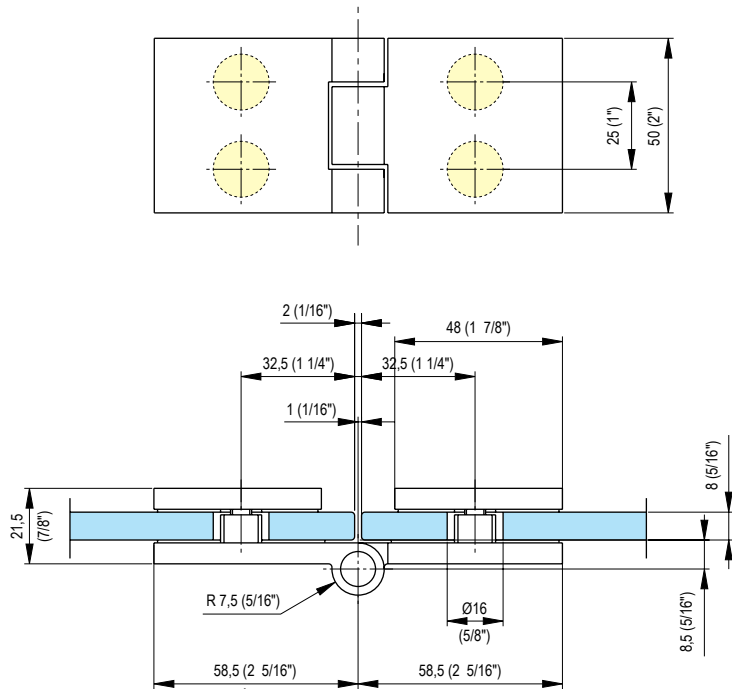
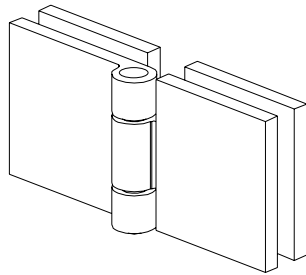

8660

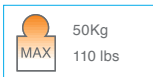
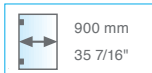
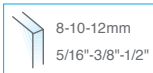

• Cerniera laterale tonda per stipiti da 20 a 30mm.

• Bisagra lateral redonda para jamba de 20 a 30mm.

• Rounded side hinge for door-jambes of 20 to 30mm.

• Rundes seitliches Scharnier für Türpfosten von 20 bis 30mm.

• Charnière latérale ronde pour chambranles de 20 à 30 mm.

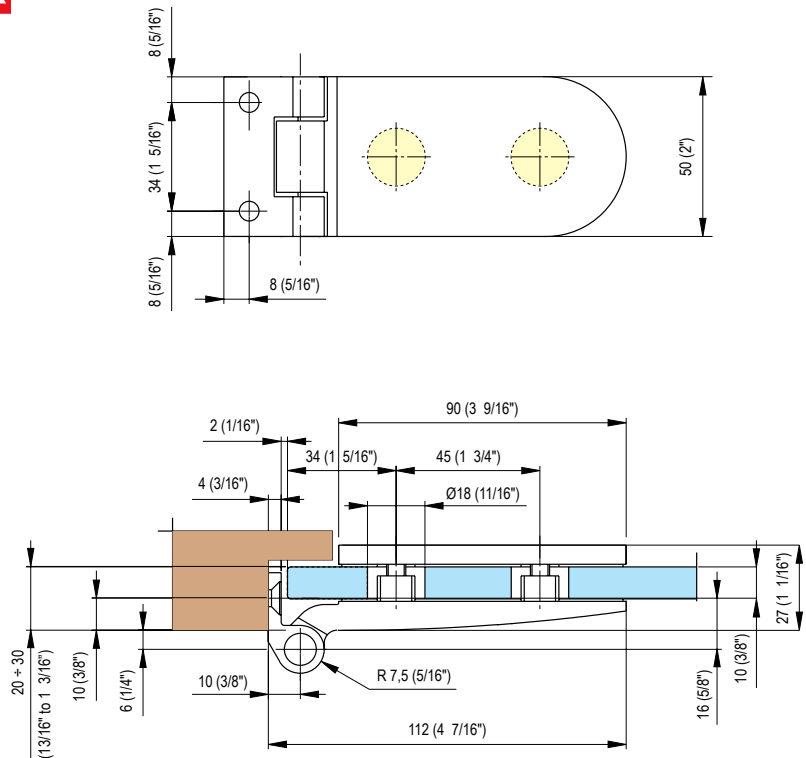
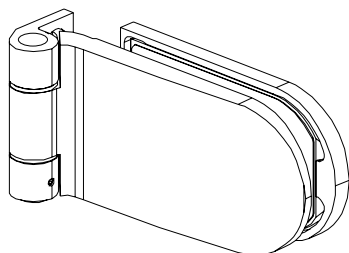

8662

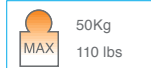
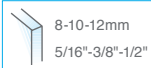

- Cerniera tonda doppia vetro-vetro. 180°.
- Bisagra redonda doble vidrio-vidrio. 180°.
- Rounded double side hinge glass to glass. 180°.
- Rundes Doppelscharnier Glas-Glas. 180°.
- Double charnière ronde verre-verre. 180°.

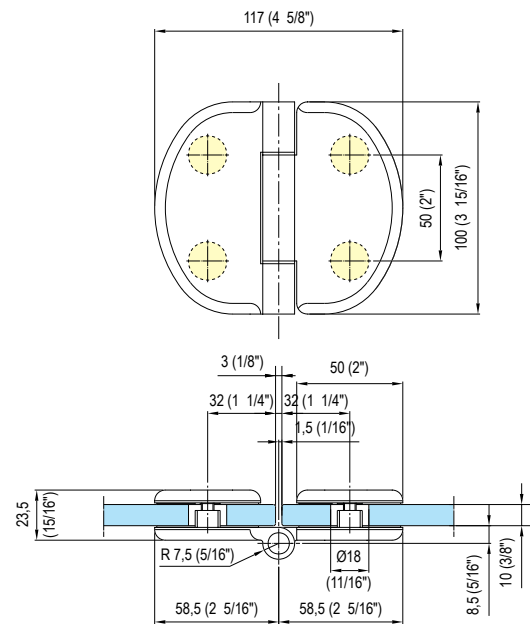
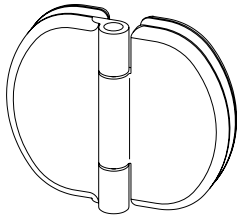

8663

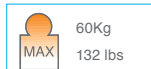
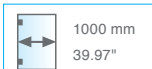
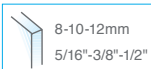

- Cerniera laterale tonda per stipite stretto.
- Bisagra redonda lateral.
- Rounded side hinge for narrow door jambs.
- Rundes, seitliches Scharnier für schmale Türpfosten.
- Charnière latérale ronde pour chambranle étroit.

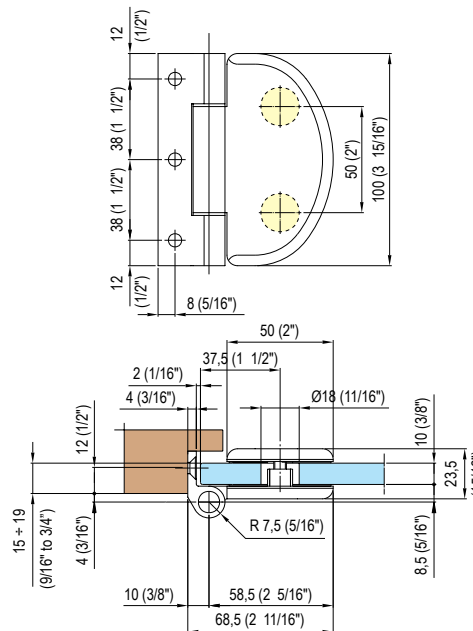
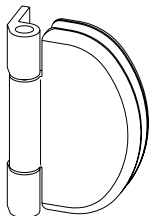

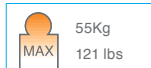
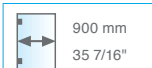
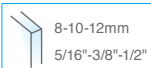

8664

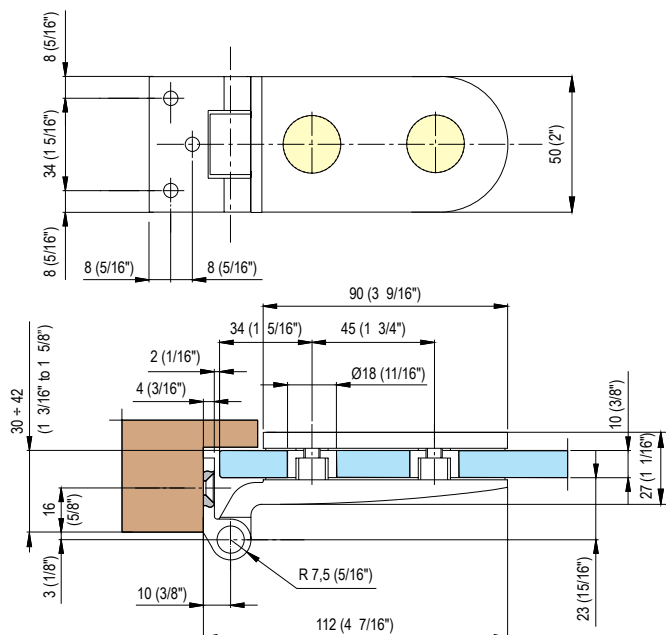
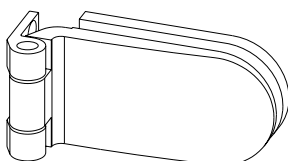

- Cerniera laterale tonda per stipiti da 30 a 42mm.
- Bisagra redonda lateral para jamba de 30 a 42mm.
- Rounded side hinge for door-jambs of 30 to 42mm.
- Rundes, seitliches Scharnier für Türpfosten von 30 bis 42mm.
- Charnière latérale ronde pour chambranle de 30 à 42mm.





8665

 8-10-12mm 5/16"-3/8"-1/2"	 900 mm 35 7/16"	 55Kg 121 lbs
--	--	---

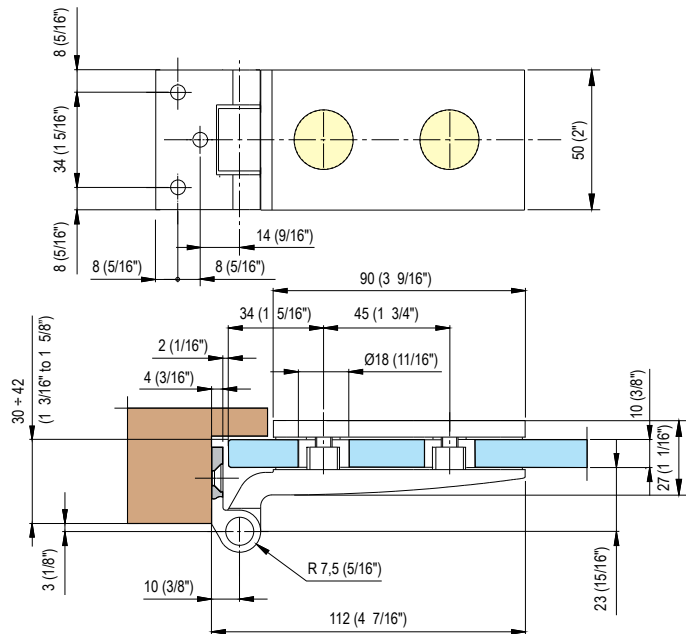
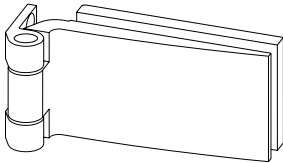
- Cerniera laterale per stipiti da 30 a 42mm.
- Bisagra lateral para jamba de 30 a 42 mm.
- Side hinge for door-jamb's of 30 to 42mm.
- Seitliches Scharnier für Türpfosten von 30 bis 42mm.
- Charnière latérale pour chambranle de 30 à 42mm.





8810

 8-10-12mm 5/16"-3/8"-1/2"	 900 mm 35 7/16"	 55Kg 121 lbs
--	--	---

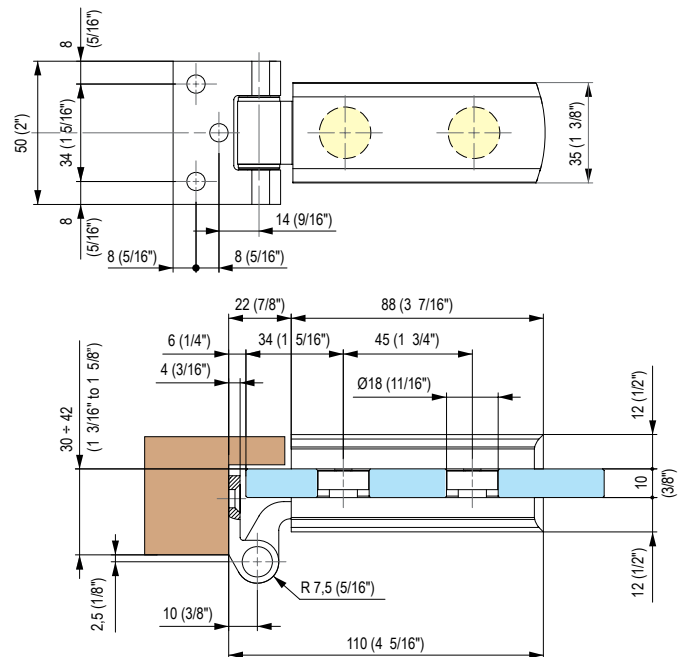
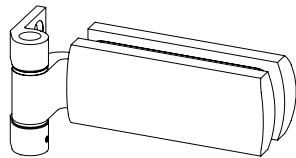
- Cerniera laterale FLEXA.
- Bisagra lateral FLEXA.
- Side hinge FLEXA.
- Seitliches Scharnier FLEXA.
- Charnière latérale FLEXA.



8666

 8-10-12mm 5/16"-3/8"-1/2"	 1000 mm 39.37"	 60Kg 132 lbs
--	---	---

- Cerniera laterale tonda per stipiti da 40 a 50mm.
- Bisagra redonda lateral para jamba de 40 a 50mm.
- Rounded side hinge for door-jamb's of 40 to 50mm.
- Abgerundetes seitliches Scharnier für Türpfosten von 40 bis 50mm.
- Charnière latérale ronde pour chambranle de 40 à 50mm.

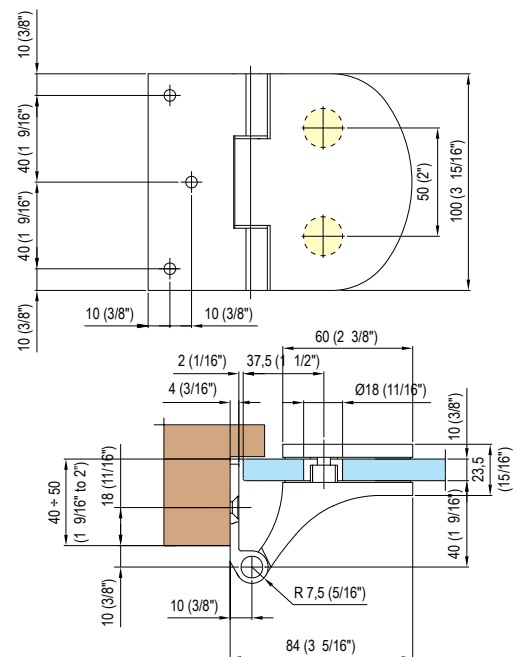
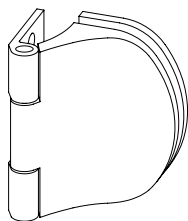

8667



8-10-12mm
5/16"-3/8"-1/2"

1000 mm
39.37"

60Kg
132 lbs
MAX

- Cerniera laterale per stipiti da 40 a 50mm.
- Bisagra lateral para jamba de 40 a 50 mm.
- Side hinge for door-jambs of 40 to 50mm.
- Seitliches Scharnier für Türpfosten von 40 bis 50mm.
- Charnière latérale ronde pour jambage de 40 à 50mm.

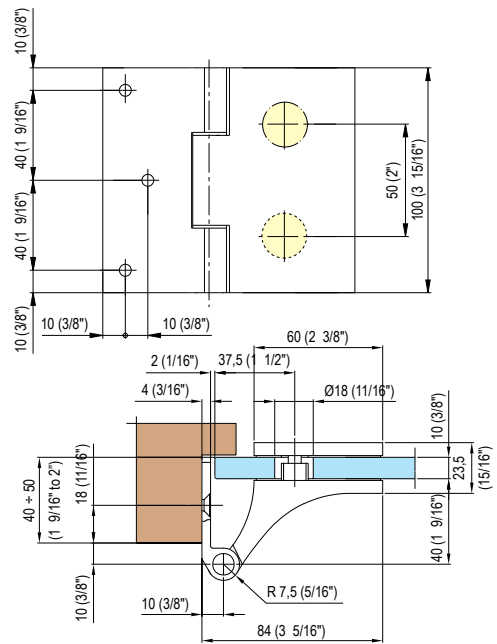
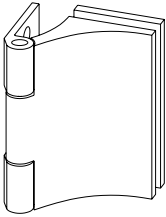

8674

8-10-12mm
5/16"-3/8"-1/2"

1000 mm
39.37"

60Kg
132 lbs
MAX

- Cerniera laterale per stipiti da 30 a 42mm.
- Bisagra lateral para jamba de 30 a 42mm.
- Side hinge for door-jambs of 30 to 42mm.
- Anschlagtürband für Falztiefen von 30 bis 42mm.
- Charnière latérale pour chambranle de 30 à 42mm.

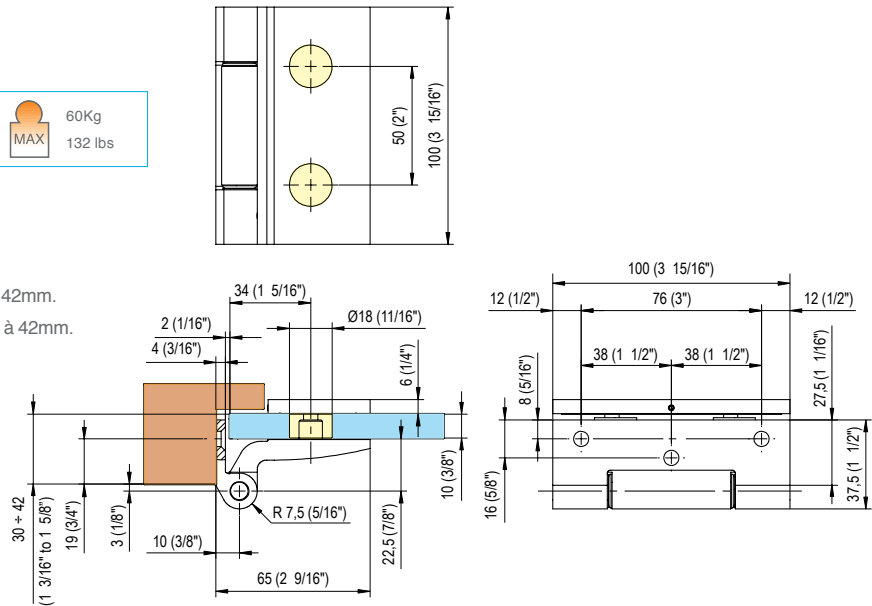
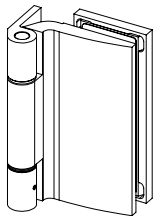

8SI0

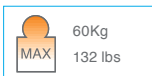
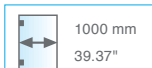
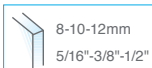

- Cerniera laterale stipite da 45mm con piastrina di fissaggio.
- Bisagra lateral con placa de fijación: plancha de 45mm.
- Side hinge for door-jamb of 45mm with fixing plate.
- Seitliches Scharnier für Türpfosten von 45mm mit Befestigungsplatte.
- Charnière latérale avec jambage de 45mm et plaque de fixation.

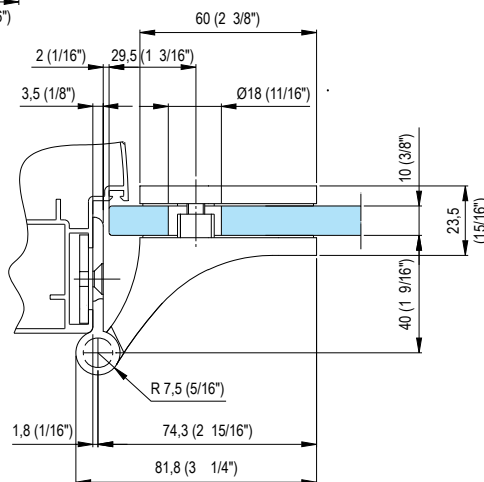
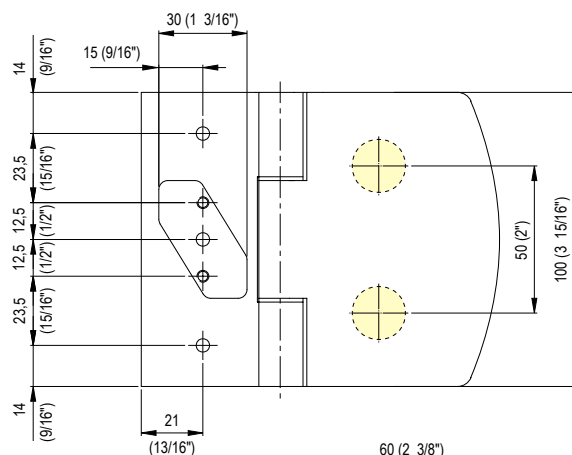
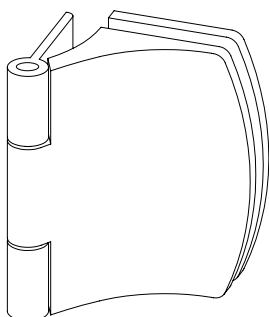

8SI1



- Cerniera per porte in legno.
- Bisagra para puertas de madera.
- Hinge for wooden doors.
- Scharnier für Holztüren.
- Charnière pour portes en bois.

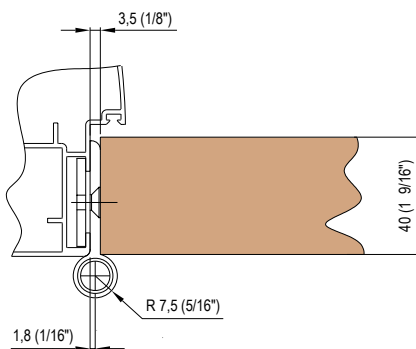
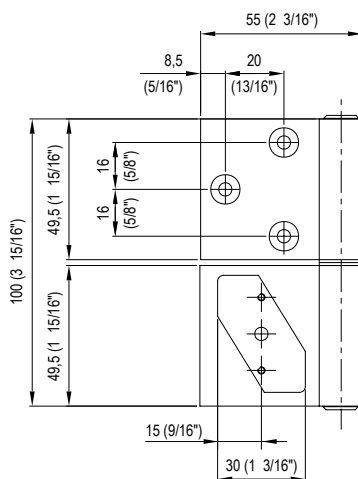
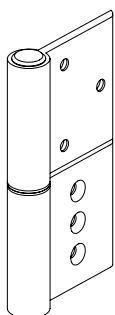

8PB7-10

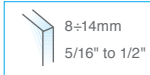

Patented ©

- Profilo adesivo ammortizzatore a palloncino.
Confezione da 12 metri.
- Perfil adhesivo amortiguador – a globo.
12 metros en el paquete.
- Bumper balloon seal. Package of 12 mt.
- Selbstklebendes Profil mit Stoßdämpferfunktion.
Paket mit 12 Metern.
- Joint adhésif amortissant en forme de ballon.
Pack de 12 mètres.

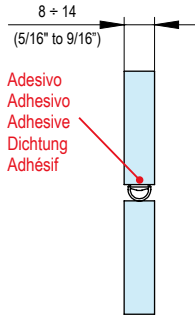
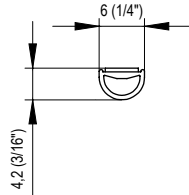

Adesivo
Adhesivo
Adhesive
Dichtung
Adhésif

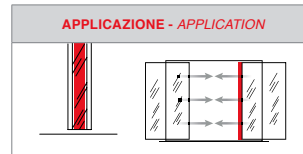

A-8PB7-10

Applicatore
Aplicador
Template
Schablone
Applicateurs



8PB7-15

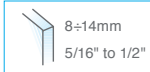

Patented ©

- Profilo adesivo a 3 labbra.
Confezione RETAIL o INDUSTRIAL.
- Perfil adhesivo (tres labios).
Paquete "RETAIL" o "INDUSTIAL".
- Adhesive seal with 3 lips.
Package RETAIL or INDUSTRIAL.
- Selbstklebendes Dichtungsprofil mit
drei Laschen. Industrieverpackung.
- Joint adhésif à 3 lèvres.
Confection RETAIL ou INDUSTRIAL.

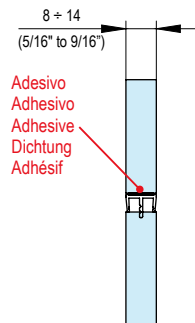
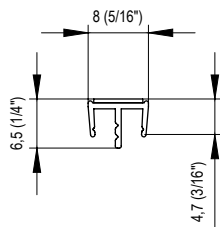

Adesivo
Adhesivo
Adhesive
Dichtung
Adhésif

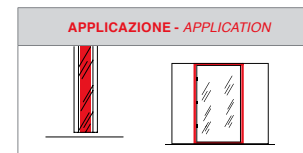

A-8PB7-15

Applicatore
Aplicador
Template
Schablone
Applicateurs

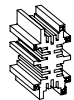

8PB7-15/10 RETAIL

10 barre da 3 metri + 2 applicatori + 2 salviette sgrassanti / 10 barras de 3mt + 2 "aplicadores" + 2 toallitas para desgrasar / 10 lengths of 3 mt. + 2 templates + 2 wipes for cleaning / 10 Längen à 3 Meter + 2 Schablonen + 2 Reinigungsets / 10 barre de 3 mètres + 2 applicateurs + 2 lingettes de dégraissage

8PB7-15/40 INDUSTRIAL

40 barre da 3 metri + 1 applicatore / 40 barras de 3mt + 1 "aplicador" / 40 lengths of 3 mt. + 1 template / 40 Längen à 3 Meter + 1 Schablone / 40 barre de 3 mètres + 1 applicateur

TC10

- Tappo copri vite.
- Tapa cobre tornillo.
- Screw cover.
- Schraubdeckel.
- Bouchon fileté.

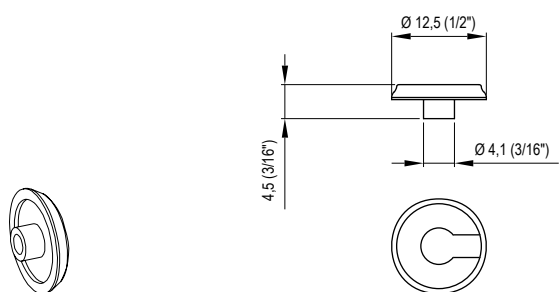

SP8610

- Spessore di regolazione per 8610.
- Cuña de regulación para art. 8610.
- Adjustment shim for 8610.
- Abstandsscheibe für 8610.
- Cale de réglage d'épaisseur pour 8610.

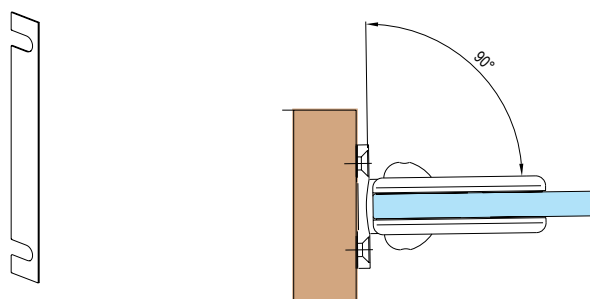
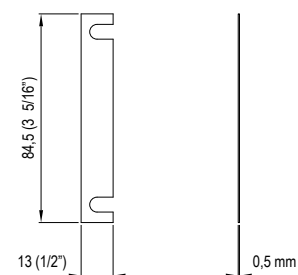

VT20

- Vite inox 5,5 x 60mm.
- Tornillo inoxidable 5,5 x 60mm.
- Stainless steel screw 5,5 x 60 mm.
- Schraube aus Edelstahl 5,5 x 60 mm.
- Vis inox 5,5 x 60mm.

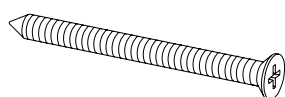
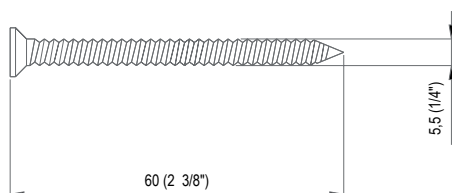

SP8630

- Spessore di regolazione per 8630 8010 8011.
- Cuña de regulación para art. 8630 8010 8011.
- Adjustment shim for 8630 8010 8011.
- Abstandsscheibe für 8630 8010 8011.
- Cale de réglage d'épaisseur pour 8630 8010 8011.

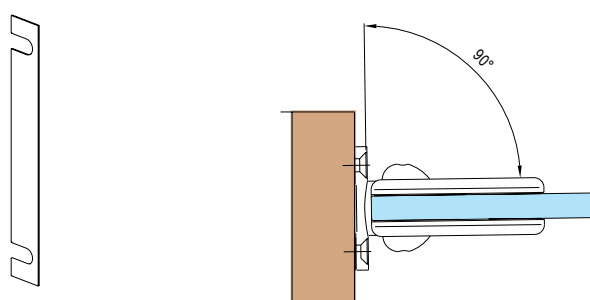
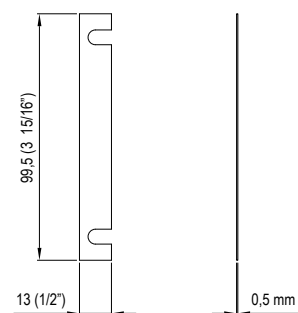



PORTE IN LEGNO

Puertas en Madera
Wooden Doors
Holztüren
Portes en Bois

cerniere oleodinamiche / oildynamic hinges

Biloba **EVO Wood**



835E40



Alluminio / Aluminium - finiture / colors 02-05-13-14-15-16-17-22-60-62

La prima cerniera con chiusura regolabile e controllo costante di frenatura, per tutte le angolazioni di apertura della porta fino a 180°. Disponibile anche nella versione con automatismo di chiusura da 90° a 0°. Controllo costante di frenatura. Cerniera libera da 90° a 180°. Fornita di un ammortizzatore anti-scardinamento e dotata di un dispositivo di sovrappressione che evita rotture in caso di stratonamento accidentale. Si installa a muro o legno e su stipiti con profilo in battuta. Profondità stipite da 30 a 50 mm.

La primera bisagra con cierre ajustable y control constante de frenado, para todos los ángulos de apertura de la puerta hasta 180°. Disponible también con cierre automático, desde 90° a 0°. Control constante de frenado. Bisagra "libre" desde 90° a 180°. Provista de un amortiguador anti-desquiciamiento y equipada con un dispositivo de superpresión que evita la rotura en caso de empujones accidentales. Se instala a pared, a madera o con puertas con perfil y tope. Profundidad estipite entre 30 y 50 mm.

The first hinge with adjustable closing and constant braking control, for all door opening angles up to 180°. Also available in the version with automatic closing from 90° to 0°. Free hinge from 90° to 180°. It prevents

unhinging through a shock absorber and has an over-pressure device that avoids breaking in accidental shoving scenarios. May be fixed to wall, wood or profiles with a stop. Jamb depth from 30 to 50 mm.

Das erste Hydraulikband mit einer regulierbaren Schließgeschwindigkeit und konstanter Kontrolle der Bremsung, für alle Öffnungswinkel der Tür bis 180°. Ebenfalls in der Automatik Version verfügbar von 90° bis 0°. Mit konstanter Bremskontrolle. Freilauf des Bandes vom 90° bis 180°. Das Band ist mit einer Dämpfung ausgestattet, die eine Aushebelung der Tür verhindert, sowie einen etwaigen Überdruck reguliert und somit Bruch durch eventuelle plötzliche Stöße kompensiert. Man kann es an der Wand, Holz oder auf Türen mit Rahmen installieren. Tiefe des Türpfosten von 30 bis 50 mm.

La première charnière avec réglage et contrôle de la vitesse de fermeture, pour tout type d'angle jusqu'à 180°. Disponible également en version fermeture automatique de 90° à 0°, avec contrôle constant de la fermeture. Charnière libre de 90° à 180°. Munie d'un amortisseur anti-dégondage et équipée d'un dispositif de suppression qui permet d'éviter la rupture en cas de choc accidentel. Peut être installé au mur, sur bois ou profils avec stop. Profondeur de jambage de 30 à 50 mm.





835E40

Biloba EVO Wood
oildynamic hinge

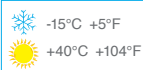
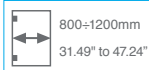
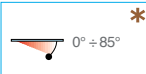

• Cerniera oleodinamica per frame e per porte in battuta, con velocità di chiusura regolabile e controllo costante di frenatura; permette un'apertura della porta fino a 180°. Stop a +90° +180°. **Si installa su porte con profilo in battuta. Profondità stipite da 30 a 50 mm.**

• Bisagra automática hidráulica para perfil y puerta con tope; regulación de velocidad de cierre de la puerta y control constante de frenado; la puerta se puede abrir hasta 180°. Stop a +90° +180°. **Se instala en puertas con perfil con batida. Profundidad estipite entre 30 y 50 mm.**

• Hydraulic hinge for frames, for doors with stop, with adjustable closing speed and constant braking control; the door opens up to 180°. Stop at +90° +180°. **Installed on doors with a profile on a stop. Jamb depth from 30 to 50 mm.**

• Hydraulikband für Profilschlagtüren, mit regulierbar Schließgeschwindigkeit und konstanter Kontrolle der Bremsung; Öffnung der Tür bis 180°. Feststellung +90° +180°. **Man kann es auf Türen mit Rahmen benutzen. Pfostentiefe von 30 bis 50 mm.**

• Charnière hydraulique pour profils en porte à butée avec contrôle constant de la vitesse de fermeture : permet une ouverture de la porte jusqu'à 180°. Stop à +90° +180°. **S'installe sur profil de porte. Profondeur du jambage de 30 à 50 mm.**

835E40 R = destra - derecha - right - rechts - droite
835E40 L = sinistra - izquierda - left - links - gauche

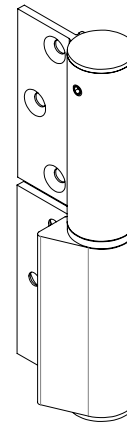

835E40L

*

• È necessaria una battuta in chiusura in quanto la cerniera ha una precarica. • Necesita de un cierre con tope, puesto que la bisagra tiene una precarga. • The hinge has a loading and it is therefore necessary a closing stop. • Eine Schließfeststellung ist notwendig, weil das Scharnier eine mechanische Belastung hat. • La charnière a une charge, il est donc nécessaire d'avoir un arrêt de fermeture.

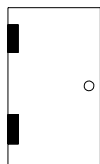

FINAL LATCH
ADJUSTEMENT SCREW

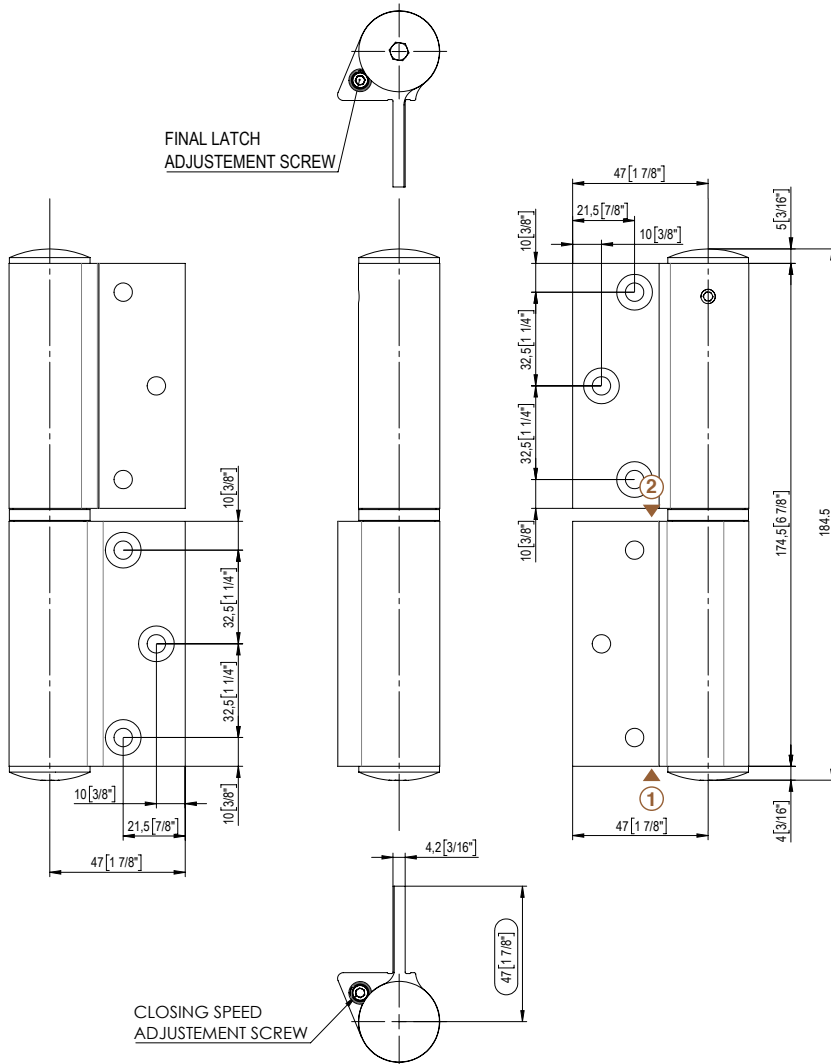

CLOSING SPEED
ADJUSTEMENT SCREW

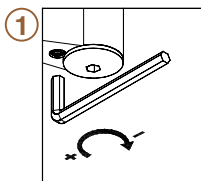

Regolazione scatto finale
Ajuste del resorte final
Final latch adjustment
Regulierung der Endschwung
Réglage de verrouillage final

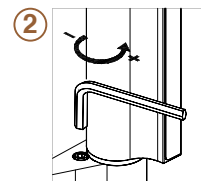

Regolazione della velocità di chiusura
Ajuste de la velocidad de cierre
Closing speed adjustment
Regulierung der Schließgeschwindigkeit
Réglage de la vitesse de fermeture

835E40SOL Biloba EVO Wood

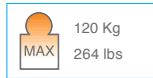
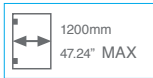

- Cerniera libera per frame e per porte in battuta. Da abbinare con 835E40.
Si installa su porte con profilo in battuta. Profondità stipite da 30 a 50 mm.
- Bisagra libre para perfil y puertas con tope. Para utilizar junto con 835E40.
Se instala en puertas con perfil con batida. Profundidad estipite entre 30 y 50 mm.
- Free hinge for frames, for doors with stop. To be matched with 835E40.
Installed on doors with a profile on a stop. Jamb depth from 30 to 50 mm.
- Freies Band für Profilschlagtüren. Zur Kombination mit 835E40.
Man kann es auf Türen mit Rahmen benutzen. Pfostentiefe von 30 bis 50 mm.
- Charnière libre pour profile en porte à butée. A combiner avec 835E40.
S'installe sur porte à butée avec profil. Profondeur jambage 30 à 50 mm.

835E40SOL R = destra - derecha - right - rechts - droite
835E40SOL L = sinistra - izquierda - left - links - gauche

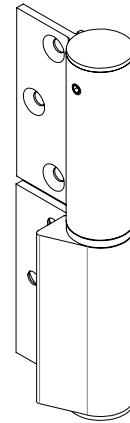

835E40SOLL

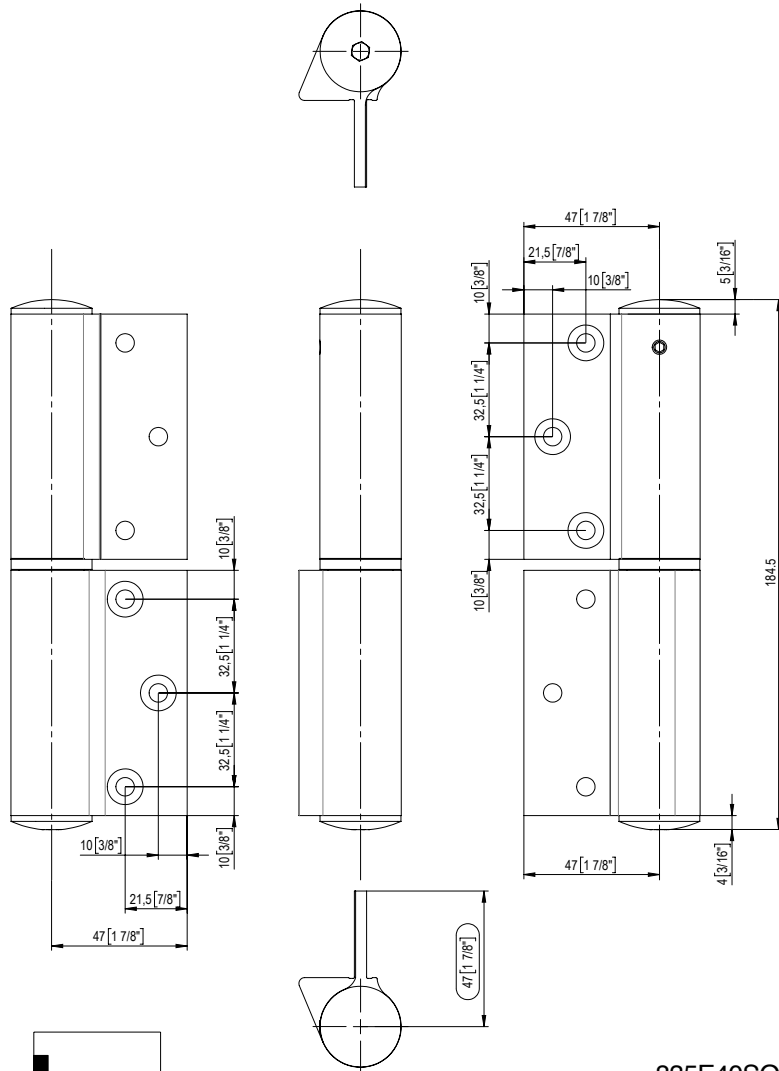

835E40SOL

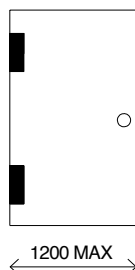

835E40SOL

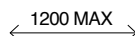

1200 MAX

835E40SOL

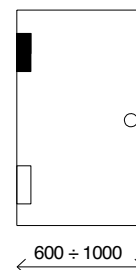

835E40

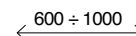

600 ÷ 1000

cerniere oleodinamiche / oildynamic hinges

Biloba **Evo VELA Wood**



845E10



845E20



Alluminio / Aluminium - finiture / colors 02

Nuova cerniera oleodinamica a scomparsa, per porte in legno con profili in battuta. La prima cerniera di Colcom completamente "nascosta" e adattabile ad ogni progetto su richiesta del cliente. Mantiene le consuete e garantite caratteristiche delle cerniere chiudiporta della serie Biloba Evo. Chiusura Oleodinamica. Personalizzabile per soddisfare ogni progetto specifico del cliente. La cerniera superiore si accompagna ed è abbinata a quella inferiore dedicata.

Bisagra hidráulica escondida, para puertas de madera con marco y tope. La primera bisagra de Colcom completamente escondida dentro el perfil, y adaptable a cualquier proyecto, a petición. Mantiene las mismas características de las bisagras Biloba Evo. Cierrapuerta hidráulico. Personalizable para satisfacer cualquier proyecto específico. Velocidad de cierre regulable. Fermo a 90°. La aplicación de la bisagra superior se completa con la bisagra inferior dedicada.

New hidden oildynamic doorcloser hinge, for framed wooden doors with a stop. The first Colcom hinge which is completely hidden, and adaptable to every project upon customer request. It maintains the same features

as the Biloba Evo series hinges. Hydraulic Closing. Customizable, in order to satisfy every specific project. The installation of the upper hinge is completed by the dedicated hidden lower hinge.

Integrierte Hydrauliktürband-, für Holztüren mit Rahmenprofil und Anschlag. Das erstes Band von Colcom, das komplett versteckt ist. Auf Anfrage kann dieses Band Kunden- und Projektspezifisch gefertigt werden. Das Band verfügt über die Merkmale der Biloba Evo Bänder. Hydraulischer Türschließer. Anpassbar, um alle Projektansprüche zu erfüllen. Schließgeschwindigkeit ist einstellbar. 90° Feststellung. Das obere Band und das untere Band bilden das komplette System.

Charnière hydraulique rétractable pour portes en bois avec profil d'arrêt. La première charnière Colcom à « disparaître » complètement, adaptable à tous les projets et aux demandes spécifiques du client. Garde les caractéristiques éprouvées et garanties des charnières ferme-porte de la série Biloba Evo. Ferme-porte hydraulique. Personnalisable, elle s'adapte au projet spécifique du client. Réglage de la vitesse de fermeture. Arrêt à 90°. La charnière supérieure est accompagnée de la charnière inférieure adaptée.





845E10

Biloba Evo VELA Wood oildynamic hinge

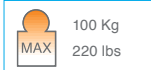
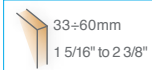

• Cerniera oleodinamica a terra a scomparsa. Per porte con frame in battuta. Velocità di chiusura regolabile e controllo costante di frenatura; permette un'apertura porta fino a 180°. Stop a +90°, anche a 180° secondo progetto parete.

• Bisagra hidráulica oculta de suelo. Para puertas batientes con marco. Velocidad de cierre ajustable y control de frenado constante; permite abertura de puerta hacia 180°. Stop a +90°, también a 180° dependiendo del proyecto de pared.

• Hidden bottom hydraulic hinge. For framed doors with a stop. Adjustable closing speed and constant braking control; the door opens up to 180°. Stop at +90°, and at +180° according to wall project.

• Einklappbares Bodenhydraulikband. Für Anschlagtüren mit Rahmen. Regulierbar Schließgeschwindigkeit und konstanter Kontrolle der Bremsung. Öffnung der Tür bis 180°. Feststellung +90° und +180° (nach Wandprojekt).

• Charnière hydraulique inférieure rétractable pour portes avec profil d'arrêt. Contrôle constant de la vitesse de fermeture; elle permet une ouverture de la porte jusqu'à 180°. Arrêt à +90°, mais aussi à +180° selon le type de paroi.

845E10 R = destra - derecha - right - rechts - droite

845E10 L = sinistra - izquierda - left - links - gauche

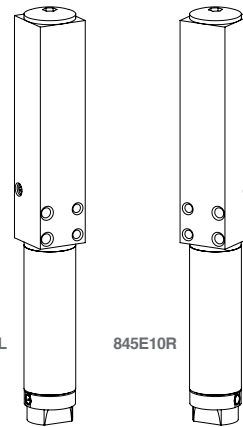

* È necessaria una battuta in chiusura in quanto la cerniera ha una precarica. • Necesita de un cierre con tope, puesto que la bisagra tiene una precarga. • The hinge has a loading and it is therefore necessary a closing stop. • Eine Schließfeststellung ist notwendig, weil das Scharnier eine mechanische Belastung hat. • La charnière a une charge, il est donc nécessaire d'avoir un arrêt de fermeture.

Per un ottimale sviluppo del progetto applicazione personalizzato è possibile rivolgersi al nostro ufficio tecnico - Para un óptimo desarrollo del proyecto de aplicación personalizada puede contactar nuestro departamento técnico - In order to have an optimal development of the application, you can consult our technical department - Für eine optimale Entwicklung des Projekts, dürfen Sie sich mit unserem Technischem Büro umdrehen - Pour un développement optimal du projet d'application personnalisée vous pouvez contacter notre service technique.

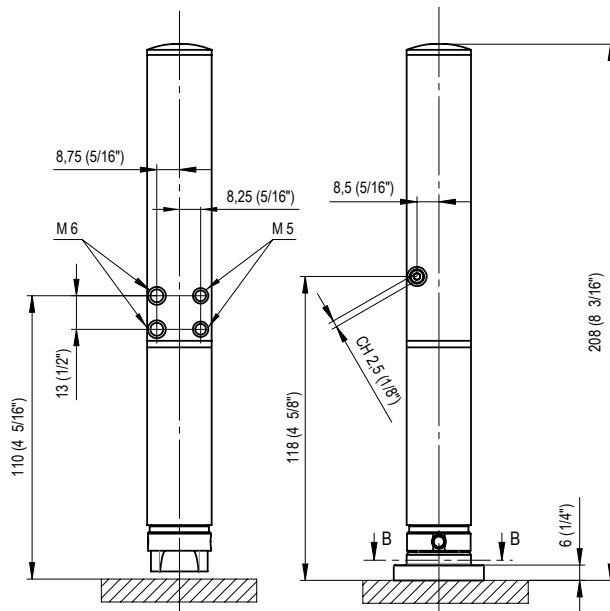

ADATTATORE PER FORO PROFILO
NON INCLUSO
ADJUSTABILITY DEVICE NOT INCLUDED

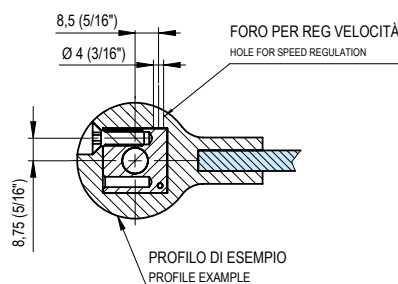
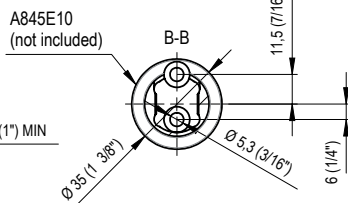
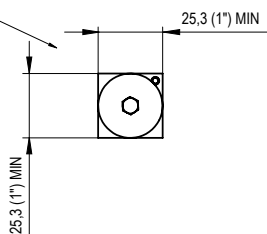

NON COMPRESO
NOT INCLUDED

A845E10



NON COMPRESO
NOT INCLUDED



VITI non comprese
not included SCREWS

PROFILO DI ESEMPIO
PROFILE EXAMPLE

FORO PER REG VELOCITÀ
HOLE FOR SPEED REGULATION

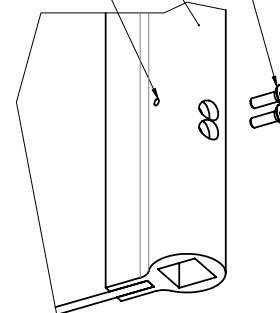

CERNIERA
HINGE

A845E10
BASE non compresa
NOT INCLUDED BASE PLATE

845E20

Biloba Evo VELA Wood

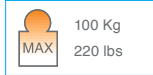
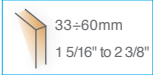

- Cerniera superiore a scomparsa. Per porte con frame in battuta. Da abbinare con 845E10.
- Bisagra superior oculta. Para puertas batientes con marco. Combinable con 845E10.
- Hidden top hinge. For framed doors with a stop. To be matched with 845E10.
- Einklappbares Oberband. Für Anschlagtüren mit Rahmen. Zur Kombination mit 845E10.
- Charnière supérieure rétractable pour portes avec profil d'arrêt. Elle s'accompagne de l'art.845E10.

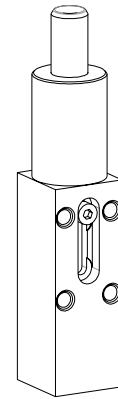

Per un ottimale sviluppo del progetto applicazione personalizzato è possibile rivolgersi al nostro ufficio tecnico - Para un óptimo desarrollo del proyecto de aplicación personalizada puede contactar nuestro departamento técnico - In order to have an optimal development of the application, you can consult our technical department - Für eine optimale Entwicklung des Projekts, dürfen Sie sich mit unserem Technischem Büro umdrehen - Pour un développement optimal du projet d'application personnalisée vous pouvez contacter notre service technique.

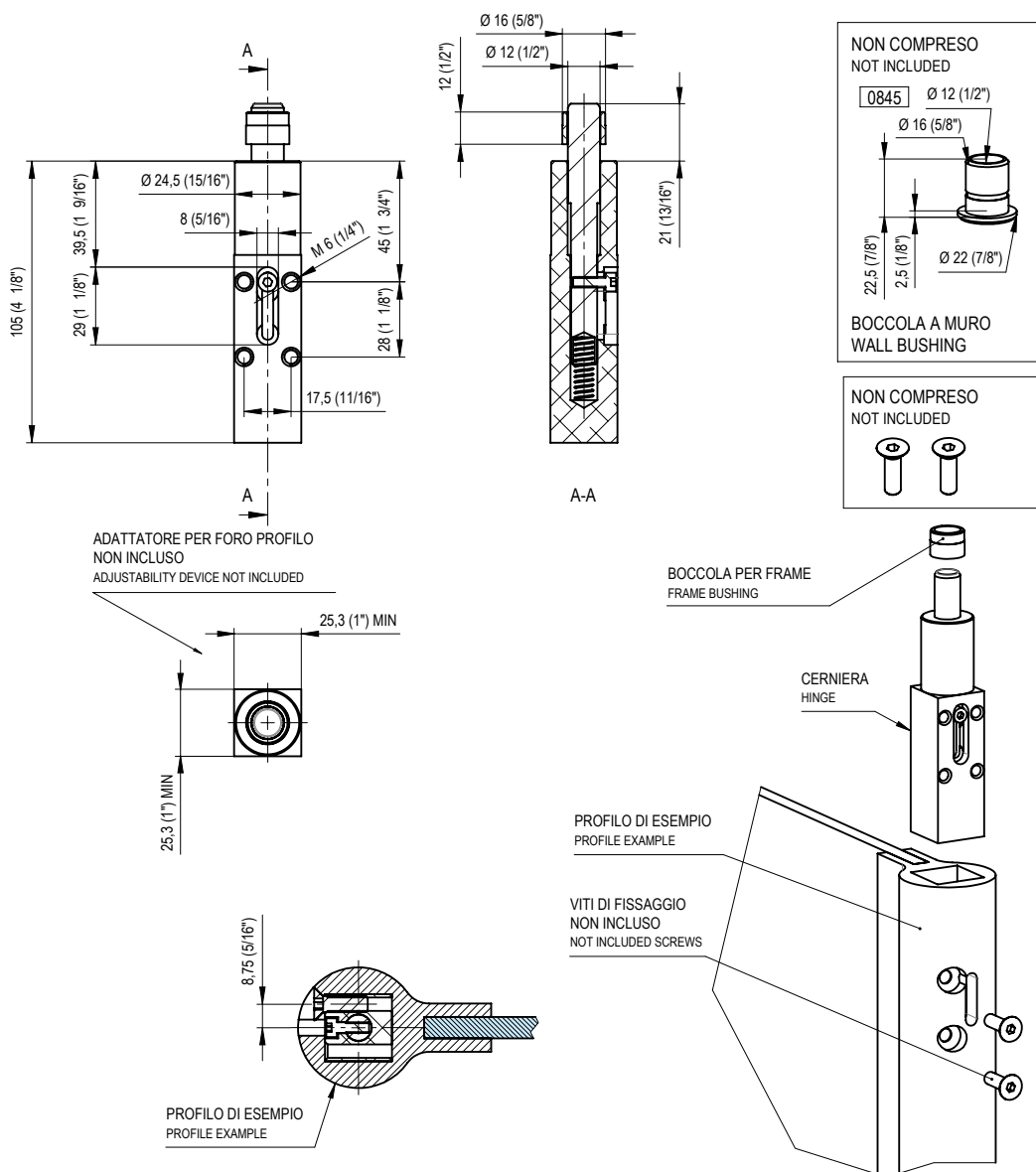

cerniere oleodinamiche / oildynamic hinges

8060WD



8060WD



Alluminio / Aluminium - finiture / colors 02-05-13-14-15-16-17-22

La cerniera 8060WD è per porte in vetro con battuta perimetrale, ed è stata creata per adattarsi ai telai in legno secondo le norme tedesche (regolamento: DIN 18101). La velocità di chiusura è regolabile e di massima sicurezza in quanto se strattinata accidentalmente non oppone resistenza. È ideale per chiusure ermetiche.

Pertenece a la familia de "Biloba" y pertenece al mismo principio de funcionamiento y patente. Es para puertas de interior con tope perimétrico y se ha creado para encajar las jambas de madera según la legislación alemana: DIN 18101.

It is for inner doors with rebated frames and it was created to suit wooden jamb according to German standards (regulation: DIN 18101).

The door movement is completely safe and in case of violent accidental pull, the door does not oppose any resistance. It is ideal for hermetic closures.

Stammt aus der patentierten Biloba Serie und hat die gleichen Bewegungsfunktionen. Dieses Türband eignet sich für Innentüren in Holzjamben gemäß deutschem Standard DIN 18101.

Est née de la famille Biloba et a le même fonctionnement et brevet. Elle pour portes intérieures avec butée périmétrale et elle s'adapte aux montants en bois selon la norme allemande DIN 18101.



8060WD

BILOBA®
oildynamic hinge

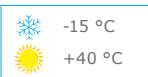
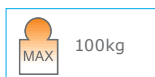
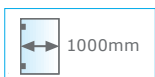
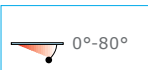

• Cerniera oleodinamica con regolazione delle velocità di chiusura dell'anta per porte in battuta. È creata per adattarsi a stipiti in legno secondo la normativa tedesca: DIN 18251 Classe 4. Stop a 0° +90°.

• Bisagra cierra puerta hidráulica con ajuste de velocidad de cierre de la puerta, con tope. Se ha creado para encajar las jambas de madera según la legislación alemana: DIN 18251 Clase 4. Freno a 0°, +90°.

• Hydraulic hinge with adjustment of the closing speed of glazing for doors with stop. It is born to suit to wooden frames according to the German regulation: DIN 18251 Class 4. Stop at 0° +90°.

• Hydraulikscharnier mit Einstellung der Türschließgeschwindigkeit bei Anschlagtüren. Sie ist für Innenanschlagentüren mit Holzrahmen gemäß deutschem Norm DIN 18251 Klasse 4 entstanden. Feststellung bei 0°+90°.

• Charnière hydraulique avec réglage de la vitesse de fermeture du battant pour porte avec butée. Il est créé pour s'adapter aux jambages en bois selon la norme allemande: DIN 18251 classe 4. Arrêt à +90°.

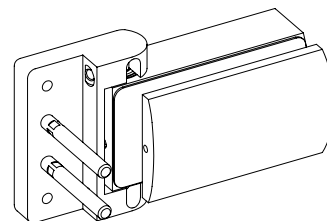
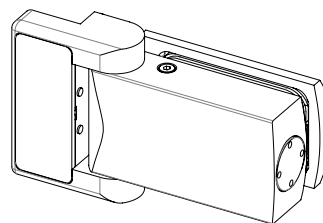

DISPONIBILE ANCHE NELLA VERSIONE "L" LIGHT CON MOLLA DEPOTENZIATA PER PORTE DI LARGHEZZA INFERIORE A 700 MM. Versione da specificare in fase d'ordine e soggetta a possibili minimi d'ordine. Per ulteriori informazioni contattare l'ufficio commerciale. - TAMBÉN DISPONIBLE "L" LIGHT - MUELLE CON MENOS FUERZA PARA PUERTAS INFERIORES A 700MM DE ANCHO. Se tendría que especificar en los pedidos y ser objeto de pedido mínimo. Nuestra oficina comercial está a su disposición para ampliar esta o cualquier otra información. - ALSO AVAILABLE IN "L" LIGHT VERSION WITH POWER-DOWNGRADED SPRING FOR DOORS WITH LESS THAN 700 MM. Both must be specified when ordered and may be subject to a minimum quantity order. For further info, please contact our export dept. - ES IST AUCH IN VERSIONE VERFÜGBAR "L" LIGHT MIT SCHWÄCHERER FEDER FÜR TÜREN UNTER 700 MM BREITE. Beide sind bei der bestellung anzugeben und könnten eine mindestbestellmenge verlangen. Für weitere informationen setzen sie sich mit unserer exportabteilung im kontakt. - EGALEMENT DISPONIBLE EN VERSION "L" LIGHT AVEC UNE FORCE RÉDUITE POUR LES PORTES DE LARGEUR INFÉRIEURE A 700 MM. Versions à préciser lors de la commande

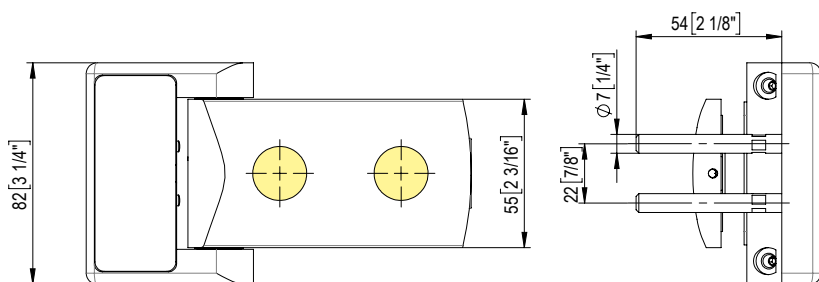

SP.VETRO/GLASS	A
8 [5/16"]	24 [15/16"]
10 [3/8"]	26 [1"]

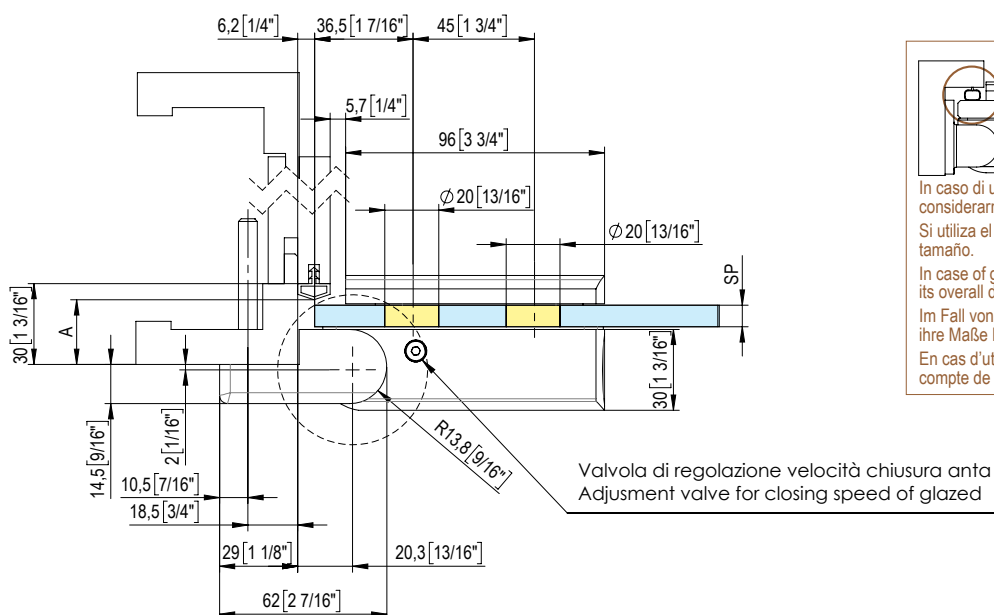

In caso di utilizzo guarnizione, considerarne l'ingombro.
Si utiliza el herraje, considerar su tamaño.
In case of gasket's usage, consider its overall dimension.
Im Fall von Dichtungsverwendung, ihre Maße berücksichtigen.
En cas d'utilisation d'un joint, tenir compte de son encombrement

TESTATA 1.000.000 CICLI
TESTED FOR 1.000.000 CYCLES

cerniera oleodinamica / oildynamic hinge

Biloba Unica **Slim Wood**



107E40



107E42/47



no finiture / not colors

Unica Slim Wood è la nuova cerniera chiudiporta oleodinamica completamente nascosta nella porta. La chiusura dell'anta è automatica. Mantiene le consuete e garantite caratteristiche delle cerniere chiudiporta della serie Biloba Unica in soli 27 mm di spessore. Nasce per porte in legno e può essere installata in porte con profili.

Unica Wood viene venduta in abbinamento alla cerniera superiore (107E42/47). Efficacia tecnica, innovazione in un'unica ed esclusiva cerniera chiudiporta.

Es la nueva bisagra hidráulica completamente escondida dentro de la puerta. El cierre de la puerta es automático. Tienes las mismas características garantizadas por la Biloba Unica, en solo 27 mm.

Proyectada para puertas de madera, puede utilizarse también en puertas con marco. Unica Wood se vende en combinación con la bisagra superior (107E42/47). Eficiencia técnica e innovación en una única y exclusiva bisagra cierra puertas.

Unica Slim Wood is the new oildynamic door closer hinge completely hidden in the door. The closing of the door is automatic. It has the usual and guaranteed features of Biloba Unica hinges in just 27 mm. It was conceived for wooden doors and can be installed on frame doors.

Unica Slim Wood is sold in combination with the upper hinge (107E42/47). Technical efficiency and innovation in a unique and exclusive door closer hinge.

Ist der neue, komplett versteckte "hydraulische" Türschließer. Die Tür wird automatisch geschlossen. Es bewahrt die gewohnten und garantierten Eigenschaften der Türschließer der Biloba Unica-Serie in nur 27 mm Stärke. Geboren für Holztüren, kann in Türen mit Profilen eingebaut werden.

Unica Slim Wood wird in Kombination mit dem oberen Scharnier (107E42/47) verkauft. Technische Effizienz und Innovation in einem einzigartigen und exklusiven Türschließer.

Est le nouveau ferme-porte hydraulique complètement caché. La porte est fermée automatiquement. Il maintient les caractéristiques habituelles et garanties des ferme-portes de la série Biloba Unica en seulement 27 mm d'épaisseur. Né pour les portes en bois, peut être installé dans des portes avec des profils.

Unica Slim Wood est vendu en combinaison avec la charnière supérieure (107E42/47). Efficacité technique, innovation dans une charnière de fermeture de porte unique et exclusive





107E40

Biloba Unica
SLIM Wood
oildynamic hinge

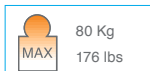
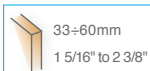
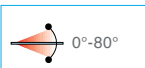

• Cerniera oleodinamica con chiusura automatica a velocità preimpostata, non modificabile. Stop a 0° +90° -90°. Abbinandola con cerniera superiore dedicata, è possibile ridurre la velocità di chiusura di pochi secondi.

• Bisagra hidráulica con cierre automático con velocidad de cierre predeterminada, no modificable. Cerrojo a 0° +90° -90°. También apta para puertas con tope. Combinando la bisagra con la bisagra superior dedicada, es posible reducir la velocidad de cierre de unos segundos.

• Hydraulic hinge with predetermined, non-modifiable automatic closing. Stop at 0° +90° -90°. Suitable for doors with a stop as well. Combining the lower hinge with the upper one allows the reduction of closing speed of some seconds.

• Hydraulikscharnier mit Feststellung der Türschließgeschwindigkeit und voreingestellte Geschwindigkeit. Stop at 0° +90° -90°. In Kombination mit dem oberen Band 106E20/27, es ist möglich, die Türschließgeschwindigkeit, um einige Sekunden zu reduzieren.

• Charnière hydraulique avec système de fermeture intégré et vitesse pré réglée, non modifiable. Arrêt à 0°, +90° et -90°. Avec la charnière supérieure 106e20/27, il est possible de réduire la vitesse de fermeture en quelques secondes.

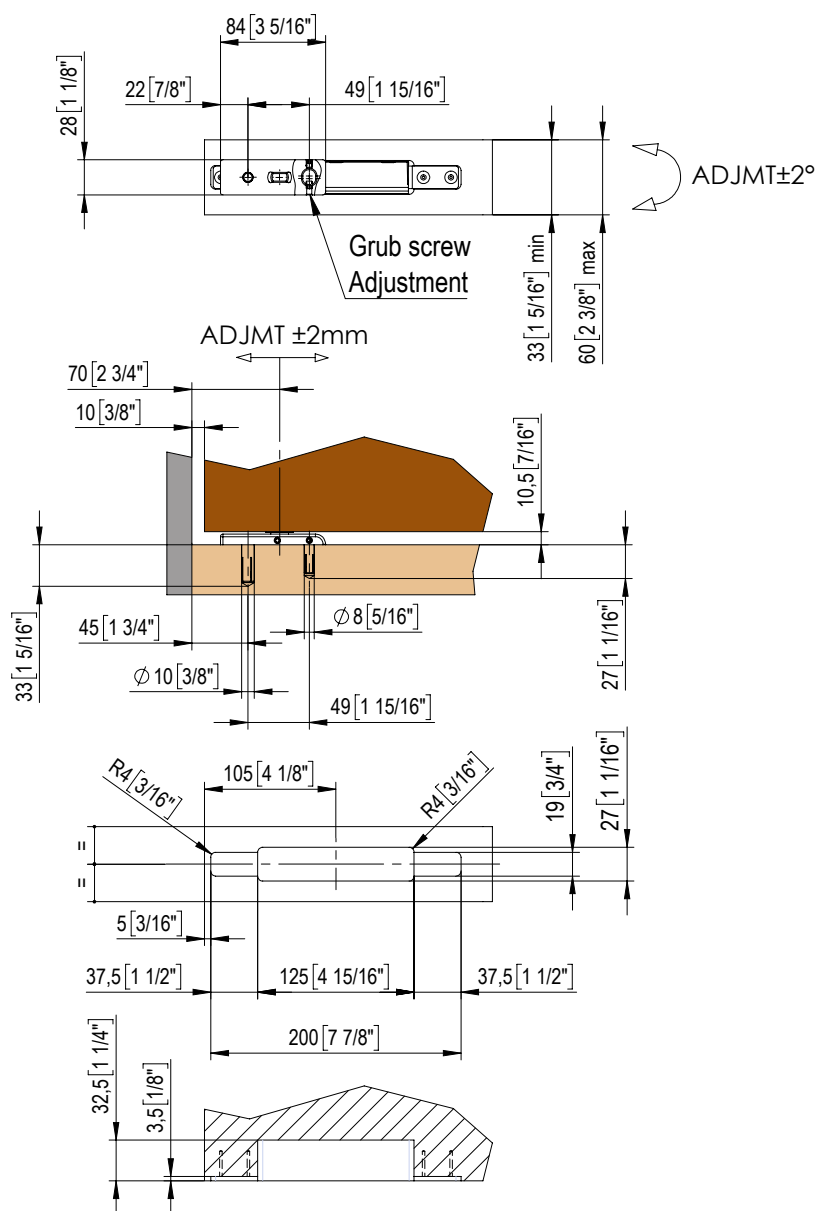
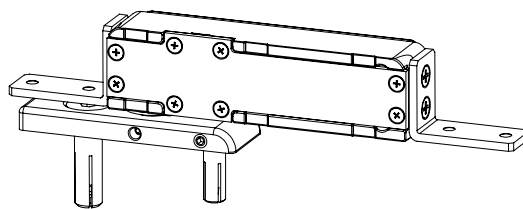

107E42/47

Biloba Unica SLIM Wood

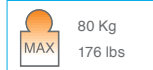
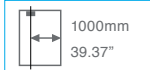
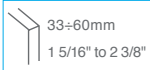

- Cerniera superiore con piletta e dispositivo frenante integrato. Da abbinare con cerniera inferiore art.107E40.
- Bisagra superior con punto de giro y dispositivo de freno integrado. Utilizar en combinación con la bisagra inferior, art. 107E40.
- Upper hinge with pivot and integrated braking system. To be used in combination with lower hinge art. 107E40.
- Oberes Band mit Zapfen und integriertem Bremsmechanismus. In Kombination mit dem unterem Band art. 107E40.
- Charnière supérieure avec axe et système de fermeture intégré. A utiliser en association avec la charnière inférieure art.107E40.

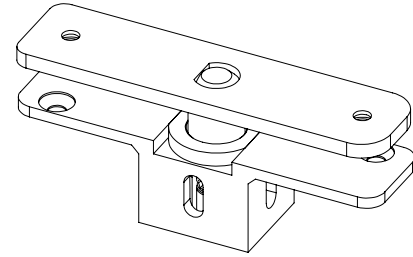

LATERAL HOLE VERSION

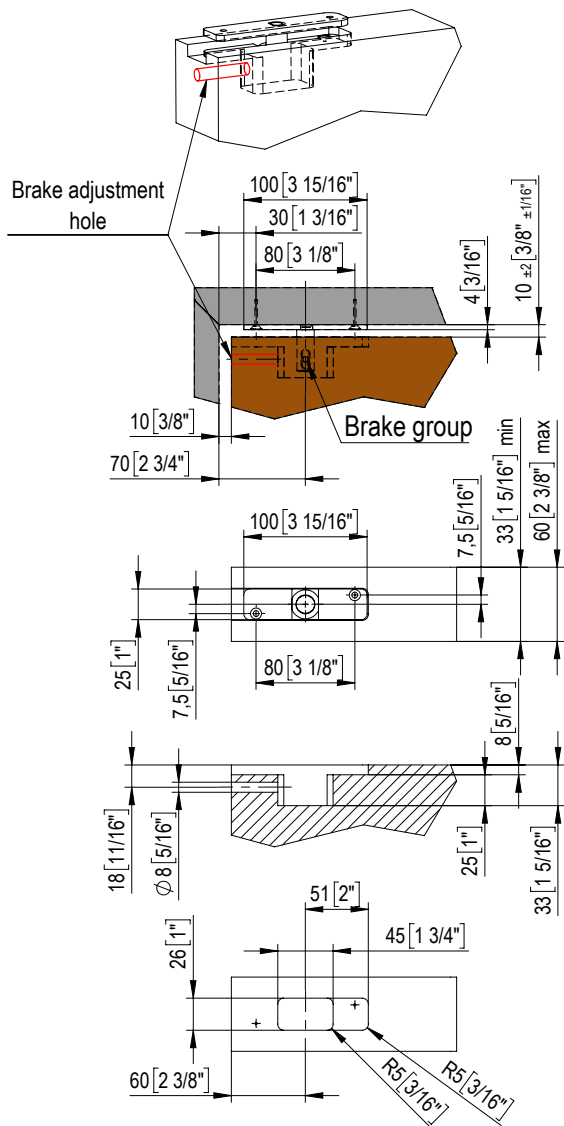

FRONT HOLE VERSION

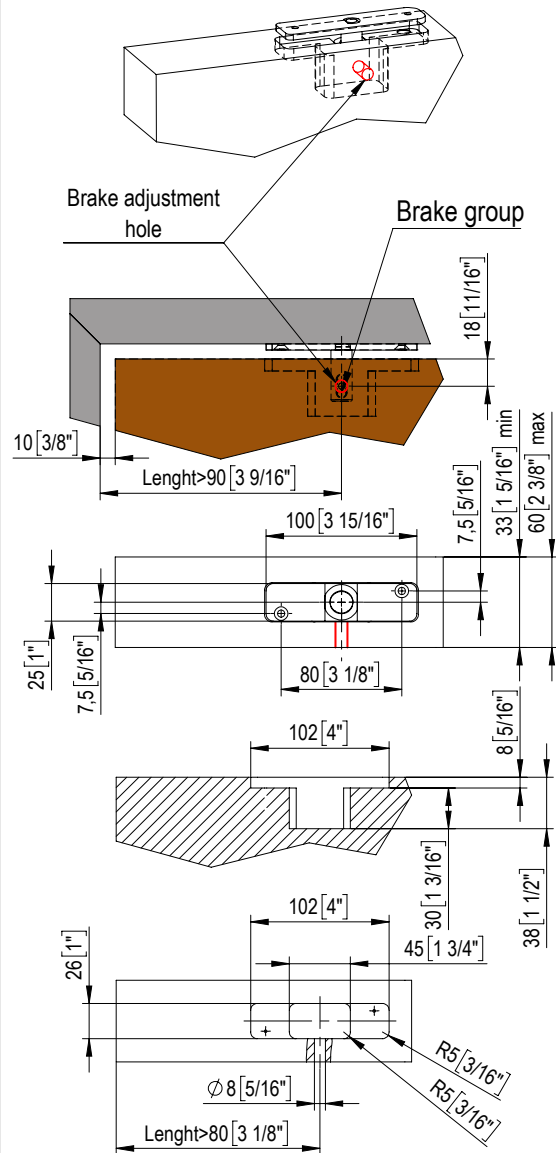





PARTIZIONI e SISTEMI PROFILI

Particiones y Perfiles sistemas
Partitioning and Profile Systems
Glasverbinder und Profilsysteme
Cloisons et Profils

profili / profiles

system **NEW STRIPE**

Alluminio / Aluminium - finiture / colors 02-05-13

NEW STRIPE è il primo profilo in alluminio modulabile disponibile sul mercato. È adatto per applicazioni in uffici ed abitazioni e permette di suddividere facilmente gli ambienti mantenendo intatta la luminosità. Il formato ed il design minimale favoriscono la posa di pareti divisorie in tempi estremamente rapidi. NEW STRIPE è la soluzione ideale per creare cornici essenziali ad ingressi in muratura e pareti in vetro. È perfettamente abbinabile al profilo per pareti divisorie P20E e P25E, alle cerniere e serrature di Colcom. Installazione rapida semplice e veloce. Possibilità di regolazione in altezza e profondità.

NEW STRIPE es el primer perfil híbrido de aluminio disponible en el mercado. Es apto para aplicaciones en oficinas y residencias, y permite dividir fácilmente los espacios dejando la luminosidad intacta. Su formato y diseño esencial facilitan la rápida instalación de particiones de vidrio. NEW STRIPE es la solución ideal para crear marcos minimalistas a entradas de mampostería o paredes de vidrio. Se combina perfectamente con los perfiles para vidrios fijos P20E y P25E, así como con las bisagras y cerraduras Colcom. Instalación rápida y sencilla. Posibilidad de ajustes en alto y profundidad.

NEW STRIPE is the first hybrid aluminium system available on the market. It is suitable for office and residential applications, and allows to divide interior spaces easily, leaving brightness untouched. Its format and minimal design make the installation of glass walls quick. NEW STRIPE is the ideal solution to create essential frames for brickwork thresholds and glass walls. It is perfectly combinable with the profiles

for glass partitioning P20E and P25E, as well as with locks and hinges from Colcom range. Quick and easy installation. Height and depth adjustment possibility.

NEW STRIPE ist das erste auf dem Markt erhältliche Hybrid-Aluminiumsystem. Es ist für Büro- und Wohnanwendungen geeignet und ermöglicht eine einfache Aufteilung der Innenräume, ohne die Helligkeit zu beeinträchtigen. Das Format und das minimale Design machen die Installation von Glaswänden schnell. NEW STRIPE ist die ideale Lösung, um wesentliche Rahmen für Mauerwerksschwellen und Glaswände zu schaffen. Es ist perfekt kombinierbar mit den Profilen für Glastrennwände P20E und P25E sowie mit Schließern und Scharnieren der Colcom-Serie. Schnelle und einfache Installation. Einstellmöglichkeit für Höhe und Tiefe.

NEW STRIPE est le premier système hybride aluminium disponible sur le marché. Il convient aux applications de bureau et résidentielles et permet de diviser facilement les espaces intérieurs en laissant la luminosité intacte. Son format et son design minimal facilitent l'installation de parois de verre. NEW STRIPE est la solution idéale pour créer des cadres essentiels pour les seuils de maçonnerie et les murs de verre. Il est parfaitement combinable avec les profils pour cloisons de verre P20E et P25E, ainsi qu'avec les serrures et charnières de la gamme Colcom. Installation rapide et facile. Possibilité de réglage en hauteur et en profondeur.





P35E

5,8m. NEW STRIPE

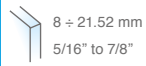

- Profilo telaio per porte in vetro.
Per vetri porta di 8-10-12mm (5/16" to 7/8").
Fissaggio a muro o su vetro.
Da abbinare a P35E61 o P35E62.
- Perfil marco para puertas en vidrio.
 Sujeta vidrios de 8-10-12mm (5/16" to 7/8").
 Fijación a pared o a vidrio.
 Combinar con P35E61 o P35E62.
- Profile for 8-10-12mm (5/16" to 7/8") glass doors.
Mountable on standard walls or glass.
To be matched with P35E61 or P35E62.
- Zargenprofil für Glastüren.
 Glasdicke von 8-10 bis 12mm (5/16" to 7/8").
 Befestigung an der Mauer oder am Glas.
 Mit P35E61 oder P35E62 kombinieren.
- Profilé pour porte en verre.
 Pour verre de 8-10-12mm (5/16" to 7/8").
 Fixation au mur ou sur verre.
 Avec P35E61 ou P35E62 combiner.

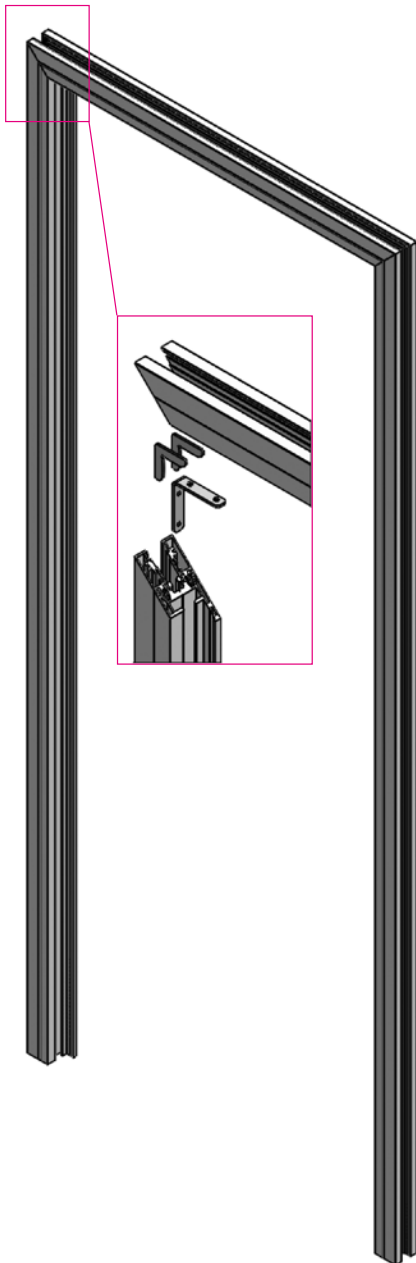

P35E60

Fissaggio a muro / Wall fixing

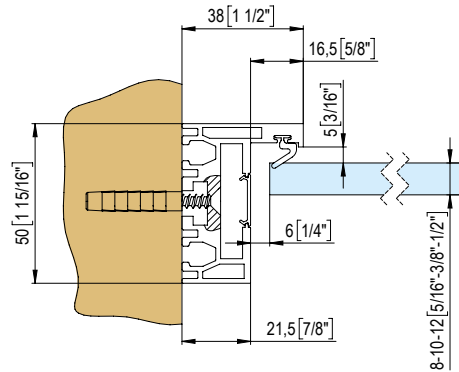

P35E60 + P35E61

Fissaggio a vetro / Glass fixing Spessore / Thickness 8 ÷ 13.52 mm [5/16" to 9/16"]

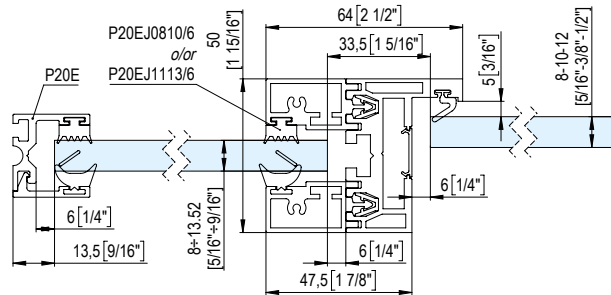

Guarnizioni per fissaggio a vetro da ordinare in base allo spessore del vetro
Gaskets for glass fixing to be purchased according to the glass thickness

P20EJ0810/6

8 - 10.76mm
5/16" - 7/16"

Coppia di guarnizioni L=5.8m.
Pareja de guarniciones L=5.8m.
Pair of gaskets L=5.8m.
Paar Dichtungsbänder L=5.8m.
Paire de garniture L=5.8m.

P20EJ1113/6

11.52 - 13.52mm
7/16" - 9/16"

Coppia di guarnizioni L=5.8m.
Pareja de guarniciones L=5.8m.
Pair of gaskets L=5.8m.
Paar Dichtungsbänder L=5.8m.
Paire de garniture L=5.8m.

P35E60 + P35E62

Fissaggio a vetro / Glass fixing Spessore / Thickness 16.76 ÷ 21.52 mm [11/16" to 7/8"]

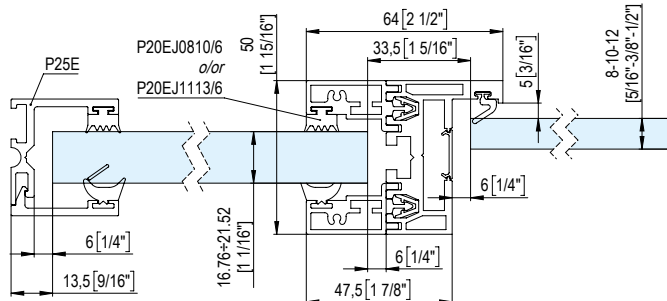

Guarnizioni per fissaggio a vetro da ordinare in base allo spessore del vetro
Gaskets for glass fixing to be purchased according to the glass thickness

P20EJ0810/6

16.76 - 17.52mm
11/16"

Coppia di guarnizioni L=5.8m.
Pareja de guarniciones L=5.8m.
Pair of gaskets L=5.8m.
Paar Dichtungsbänder L=5.8m.
Paire de garniture L=5.8m.

P20EJ1113/6

20.76 - 21.52mm
13/16" - 7/8"

Coppia di guarnizioni L=5.8m.
Pareja de guarniciones L=5.8m.
Pair of gaskets L=5.8m.
Paar Dichtungsbänder L=5.8m.
Paire de garniture L=5.8m.

P35E60 Compresso / Including

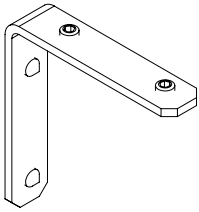

P35EP22 (x2)

Squadra di fissaggio
Escuadra de fijación
Mounting bracket
Befestigungswinkel
Équerre de fixation

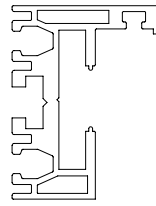

P35EG40/6 (x1)

Profilo battuta L = 5800 mm / [228 3/8"]
Perfil para jamba L = 5800 mm / [228 3/8"]
Profile for doors with rebate L = 5800 mm / [228 3/8"]
Profil für Türen mit Stop L = 5800 mm / [228 3/8"]
Profil en butée L = 5800 mm / [228 3/8"]



P35EG43/3 (x2)

Profilo copriviti L = 3000 mm / [118 1/8"]
Perfil tapas de los tornillos L = 3000 mm / [118 1/8"]
Profile screw covers L = 3000 mm / [118 1/8"]
Profil Schraubenabdeckungen L = 3000 mm / [118 1/8"]
Profil couvercles à vis L = 3000 mm / [118 1/8"]



P35EJ02/6 (x1)

Guarnizione per porta L = 5800 mm / [228 3/8"]
Sellar para puertas L = 5800 mm / [228 3/8"]
Seal for door, length L = 5800 mm / [228 3/8"]
Türdichtung für Seitenteil Befestigung L = 5800 mm / [228 3/8"]
Joints pour porte L = 5800 mm / [228 3/8"]

P35E61 Compresso / Including

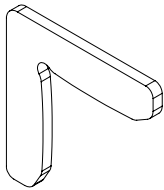

PDAUG07 (x4)

Piatto di allineamento
Platillo de alineación
Alignment plate
Ausgleichplatte
Plateau d'alignement

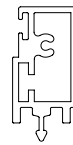

P35EG41/6 (x2)

Profilo ferma vetro L = 5800 mm / [228 3/8"]
Perfil parada de vidrio L = 5800 mm / [228 3/8"]
Profile glass stop L = 5800 mm / [228 3/8"]
Profil glas stop L = 5800 mm / [228 3/8"]
Profil arrêt de verre L = 5800 mm / [228 3/8"]



JDAUV40 (x9)

Guarnizione ad incastro L = 1400 mm / [55 1/8"]
Sellar entrelazado L = 1400 mm / [55 1/8"]
Seal joint, length L = 1400 mm / [55 1/8"]
Türdichtung ineinandergreifend L = 1400 mm / [55 1/8"]
Joints s'emboitant L = 1400 mm / [55 1/8"]

P35E62 Compresso / Including

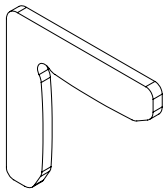

PDAUG07 (x4)

Piatto di allineamento
Platillo de alineación
Alignment plate
Ausgleichplatte
Plateau d'alignement



P35EG42/6 (x2)

Profilo ferma vetro L = 5800 mm / [228 3/8"]
Perfil parada de vidrio L = 5800 mm / [228 3/8"]
Profile glass stop L = 5800 mm / [228 3/8"]
Profil glas stop L = 5800 mm / [228 3/8"]
Profil arrêt de verre L = 5800 mm / [228 3/8"]



JDAUV40 (x9)

Guarnizione ad incastro L = 1400 mm / [55 1/8"]
Sellar entrelazado L = 1400 mm / [55 1/8"]
Seal joint, length L = 1400 mm / [55 1/8"]
Türdichtung ineinandergreifend L = 1400 mm / [55 1/8"]
Joints s'emboitant L = 1400 mm / [55 1/8"]

Non compresso / Not included

P20E

8 ÷ 13.52mm
5/16" to 9/16"

P20EC

8 - 10.76mm
5/16" - 7/16"

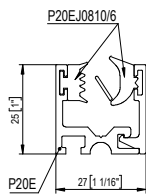

11.52 - 13.52mm
7/16" - 9/16"

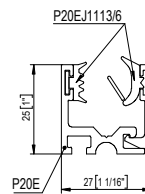

8 - 10.76mm
5/16" - 7/16"

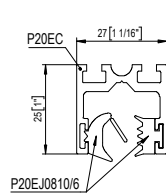

11.52 - 13.52mm
7/16" - 9/16"

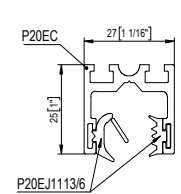

P25E

16.76 ÷ 21.52mm
11/16" to 7/8"

P25EC

16.76 - 17.52mm
11/16"

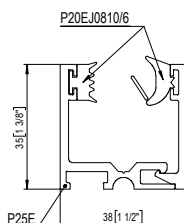

20.76 - 21.52mm
13/16" - 7/8"

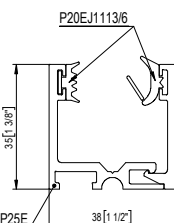

16.76 - 17.52mm
11/16"

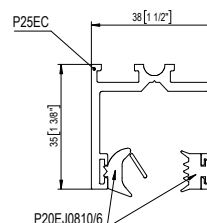

20.76 - 21.52mm
13/16" - 7/8"

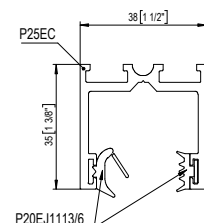

P35EP90

Elemento di collegamento con P20E - P35E
 Pieza de conexión con P20E - P35E
 Link with P20E - P35E
 Verbindungselement passend zu P20E - P35E
 Élément de raccord avec P20E - P35E

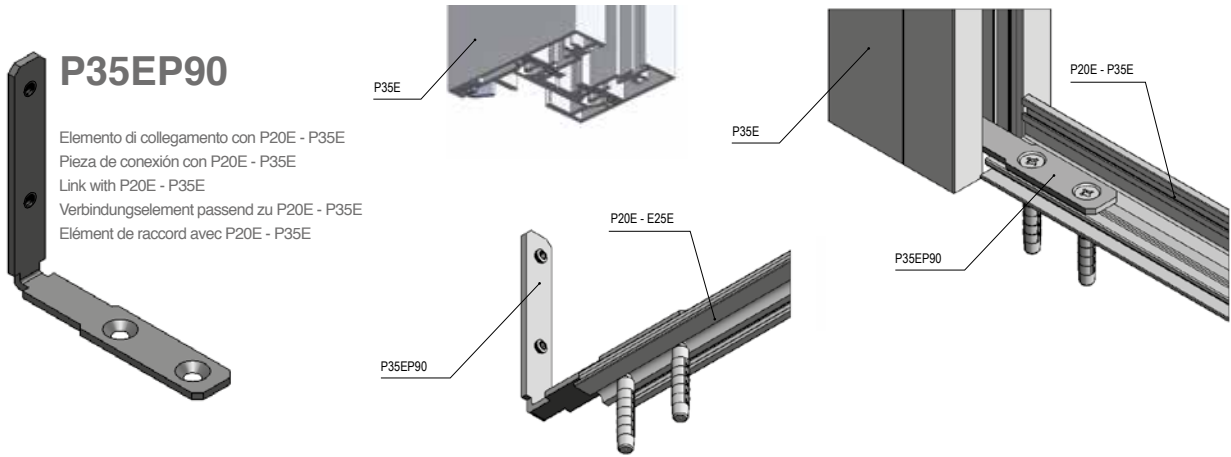

Flexa series



0P35E1



622E10R/L

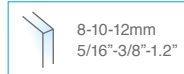

0P35E3



LOQ series



0P35E2



620E10R/L

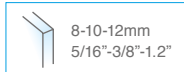

0P35E4



MAGNETIC LOQ series



0P35E5



0P35E1

Piastrina regolabile per Flexa
 Platinilla ajustable para Flexa
 Adjustable plate for Flexa
 Schließblech regulierbar für das Flexa
 Plaquelette réglable pour Flexa

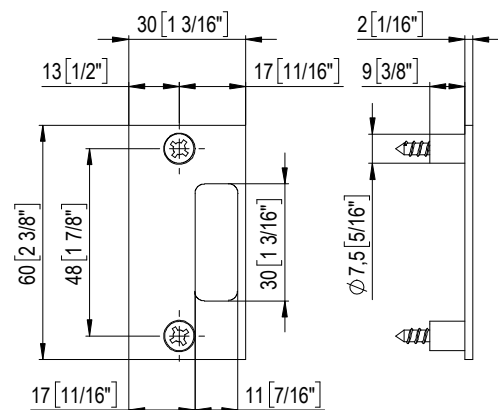
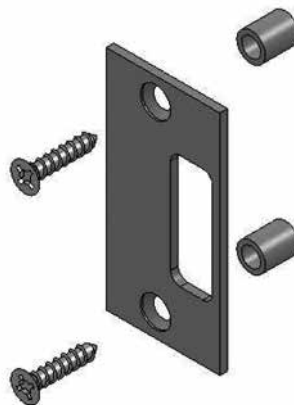

0P35E2

Piastrina regolabile per Loq
 Platiilla ajustable para Loq
 Adjustable plate for Loq
 Schließblech regulierbar für das Loq
 Plaque réglable pour Loq

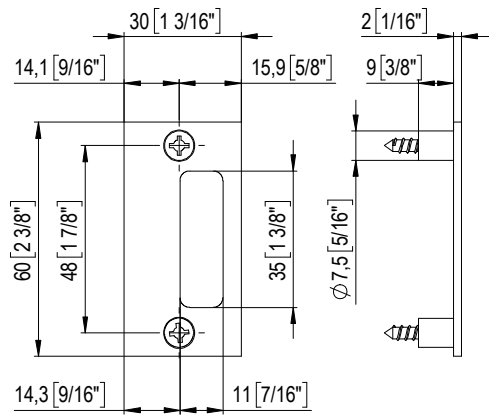
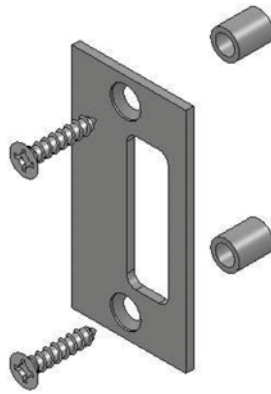

0P35E3

Piastrina regolabile per Serratura magnetica verticale
 Placa ajustable para cierre magnético vertical
 Adjustable plate for vertical magnetic lock
 Einstellbare Platte für vertikale Magnetverriegelung
 Plaque ajustable pour serrure magnétique verticale

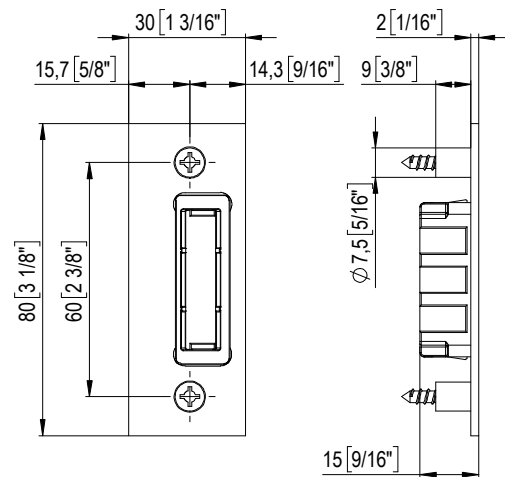
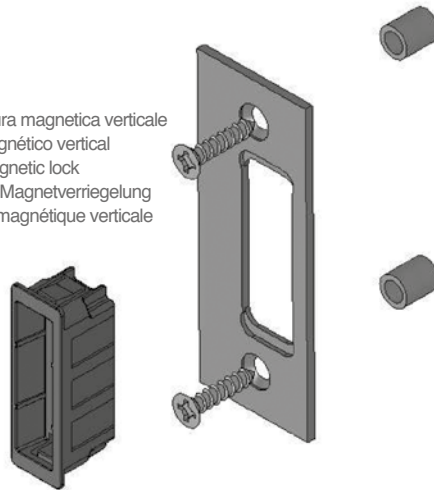

0P35E4

Piastrina regolabile per serratura verticale
 Platiilla ajustable para bloqueo vertical
 Adjustable plate vertical lock
 Schließblech regulierbar für Vertikale Verriegelung
 Plaque réglable pour serrure verticale

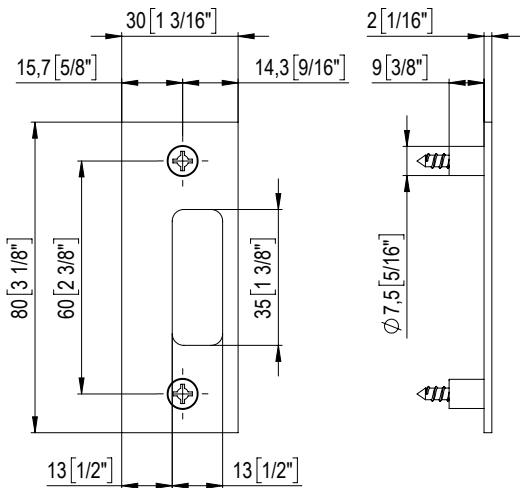
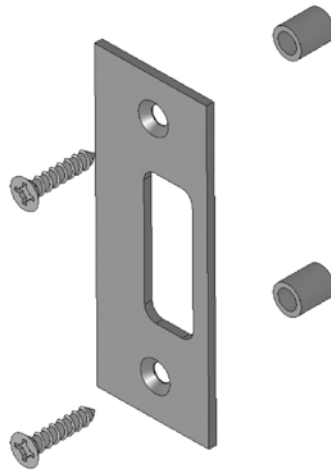

0P35E5

Piastrina regolabile per Magnetic Loq
 Platiilla ajustable para Magnetic Loq
 Adjustable plate for Magnetic Loq
 Schließblech regulierbar für das Magnetic L
 Plaque réglable pour Magnetic Loq

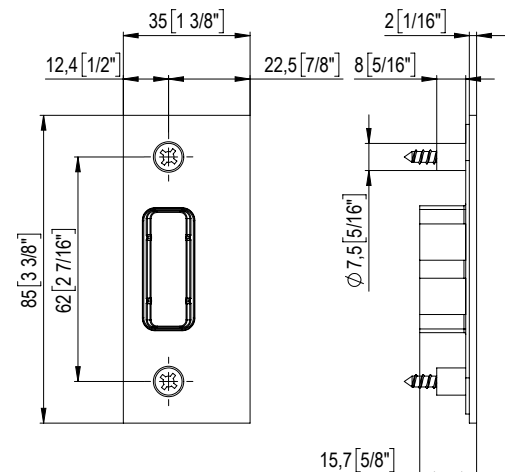
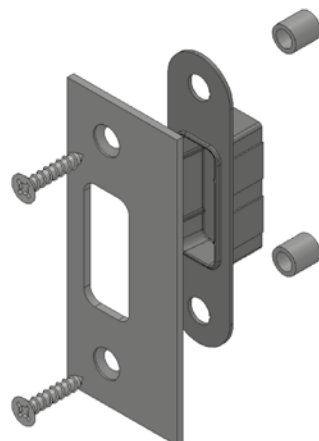

8060P1

NEW STRIPE

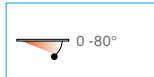
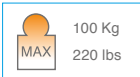
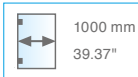
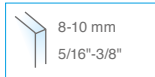

- Cerniera Oleodinamica per profilo P35E
- Bisagra hidráulica para perfil P35E
- Hydraulic hinge for P35E profile
- Hydraulisches Scharnier für P35E-Profil
- Charnière hydraulique pour profilé P35E

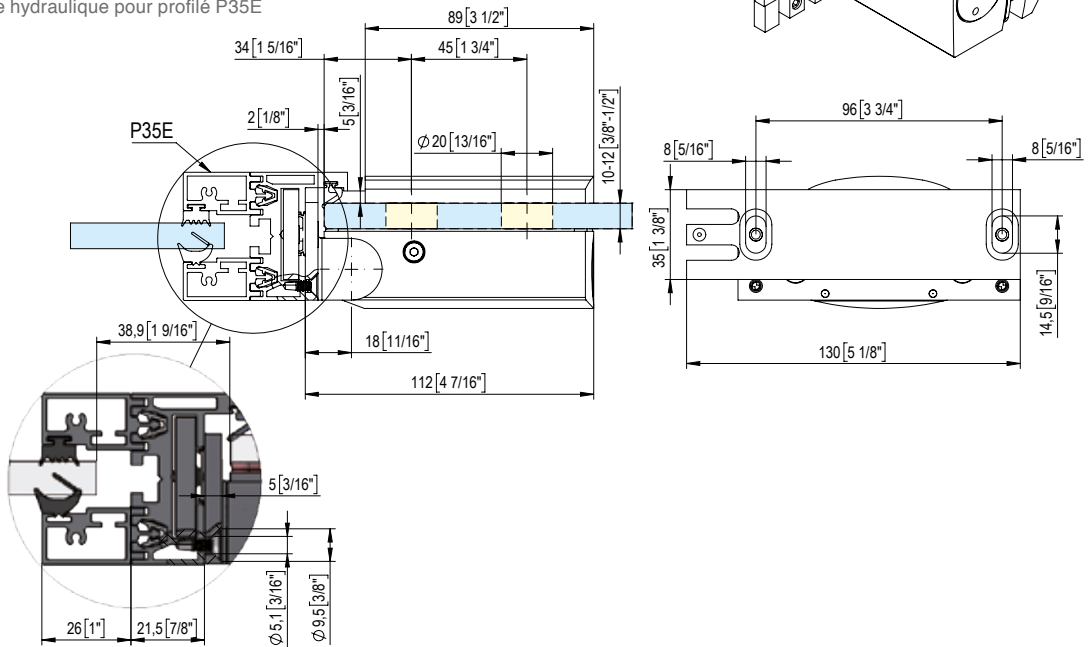
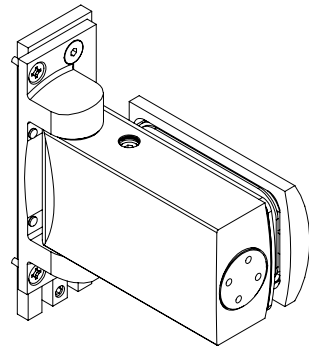

8664P1

NEW STRIPE

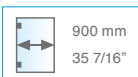
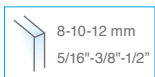

- Cerniera laterale tonda per profilo P35E
- Bisagra lateral redonda para perfil P35E.
- Round side hinge for P35E profile.
- Seitliches Band in Rundform passend zu Profil P35E.
- Charnière latérale ronde pour profil P35E

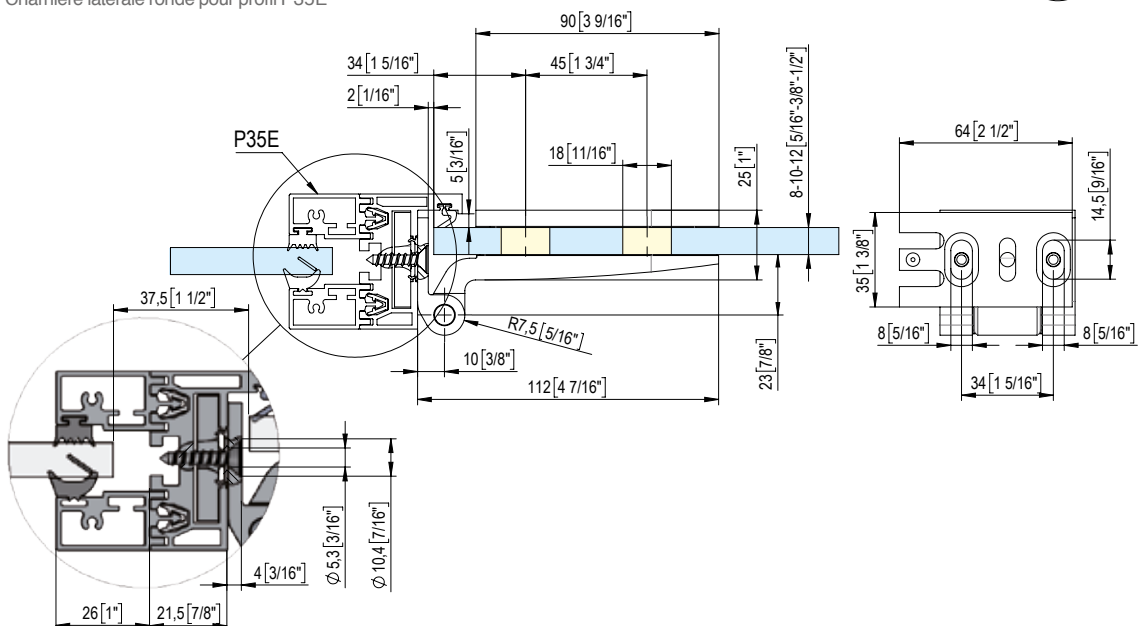
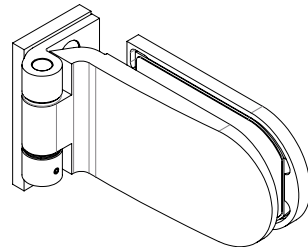

8665P1

NEW STRIPE

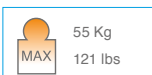
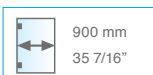

- Cerniera laterale per profilo P35E
- Bisagra lateral para perfil P35E
- Side hinge for P35E profile
- Seitliches Band in Eckform passend zu Profil P35E
- Charnière latérale pour profil P35E

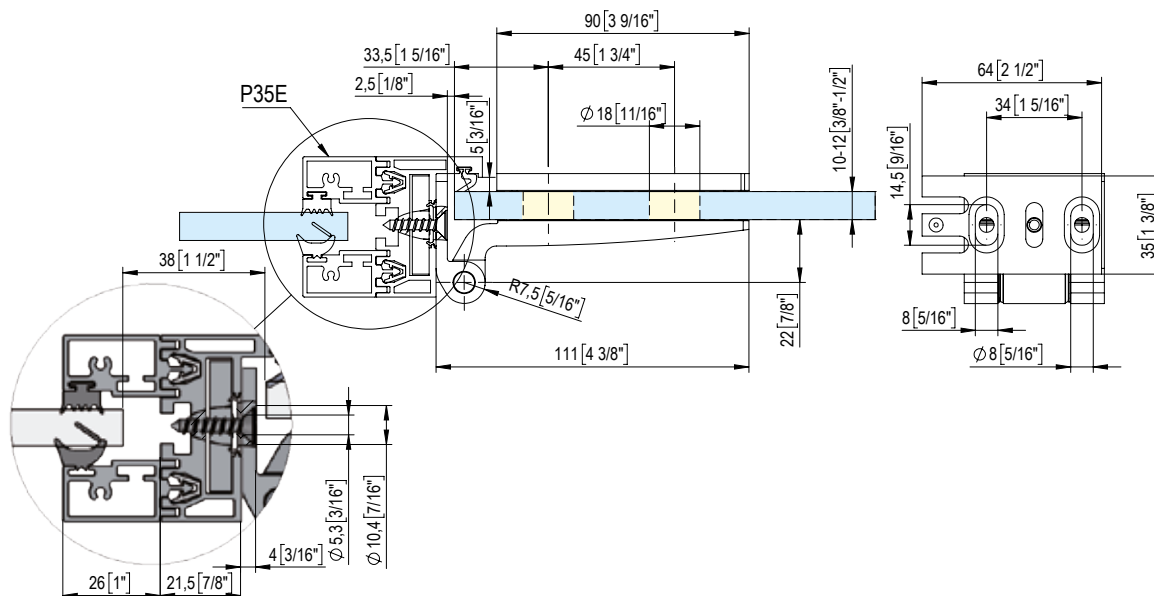
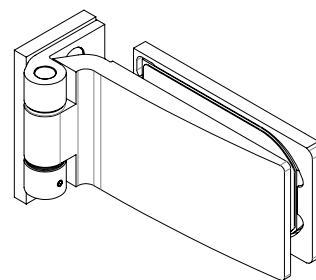

8674P1

NEW STRIPE

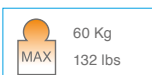
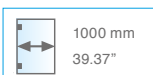

- Cerniera laterale per profilo P35E
- Bisagra lateral para perfil P35E
- Side hinge for P35E profile
- Seitliches Band in Eckform passend zu Profil P35E
- Charnière latérale pour profil P35E

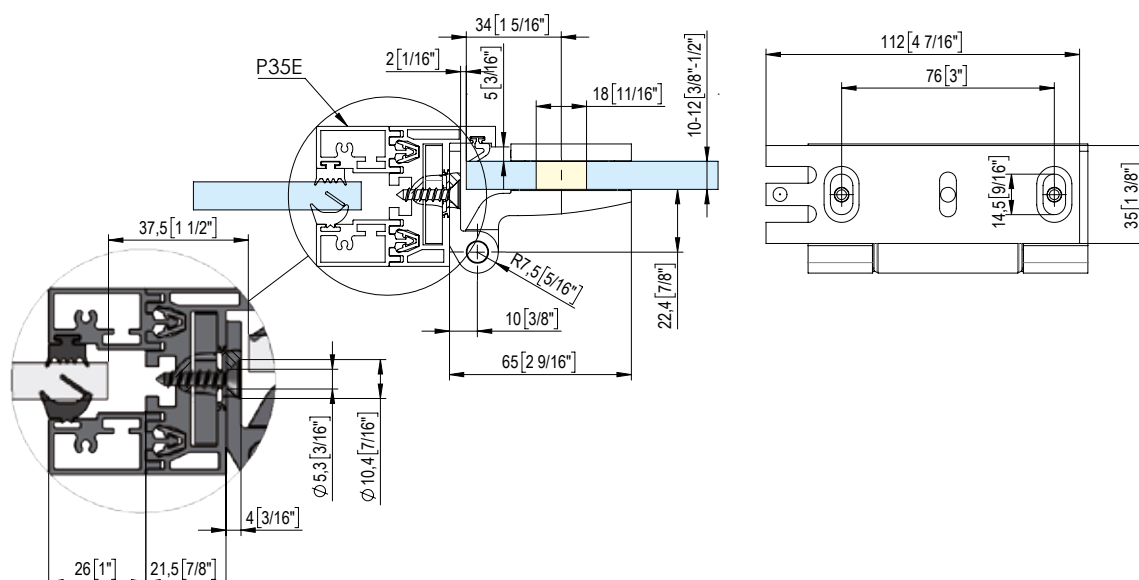
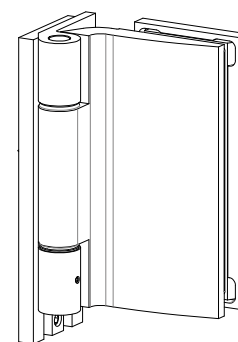
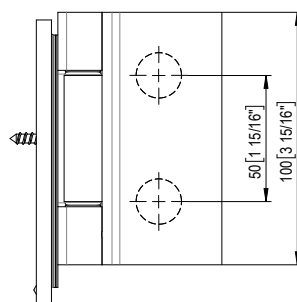

8810P1

NEW STRIPE

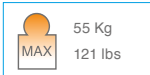
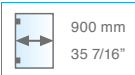
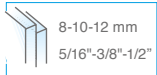

- Cerniera laterale FLEXA per profilo P35E
- Bisagra lateral Flexa para perfil P35E.
- Side hinge FLEXA for P35E profile.
- Seitlicher Band FLEXA passend zu Profil P35E.
- Charnière latérale FLEXA pour profil P35E.

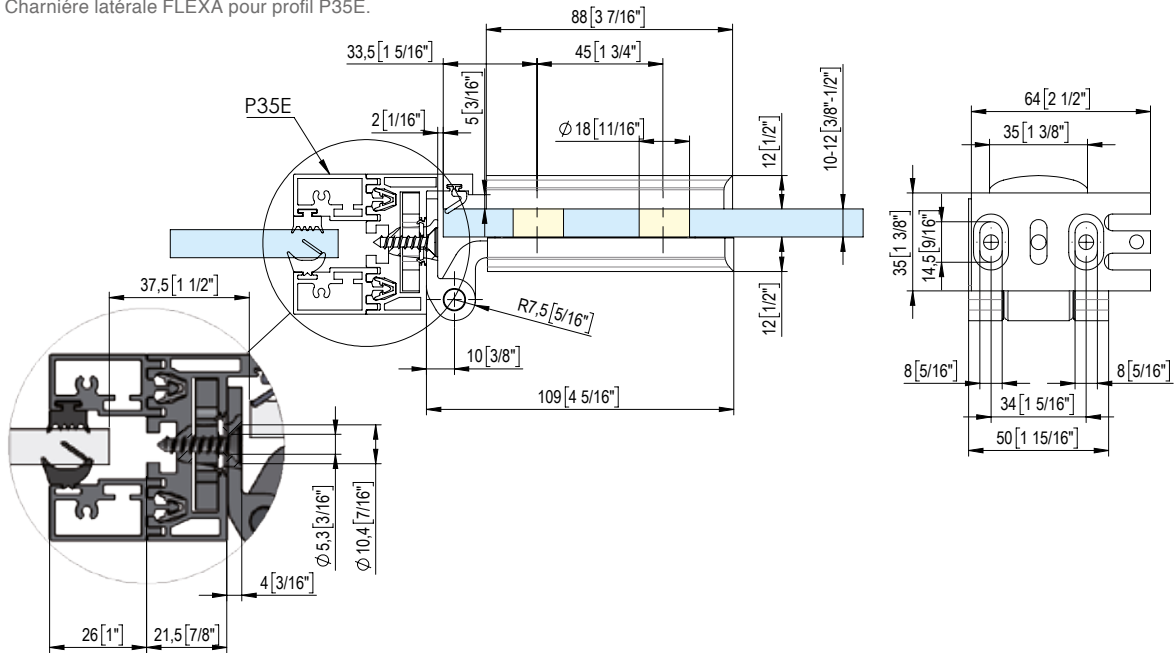
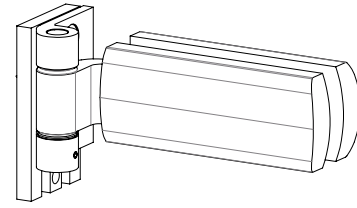

K835E

NEW STRIPE

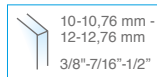

- Kit per cerniera EVO per profilo P35E
- Kit para bisagra EVO para perfil P35E
- Kit for EVO hinge for P35E profile
- Kit für EVO-Scharnier für P35E-Profil
- Kit pour charnière EVO pour profilé P35E

K835E

Non compreso

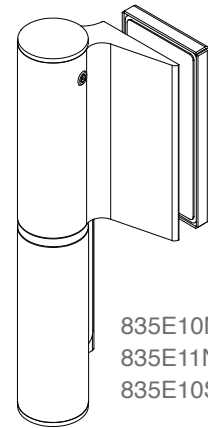

835E10N
835E11N
835E10SOL

Not included

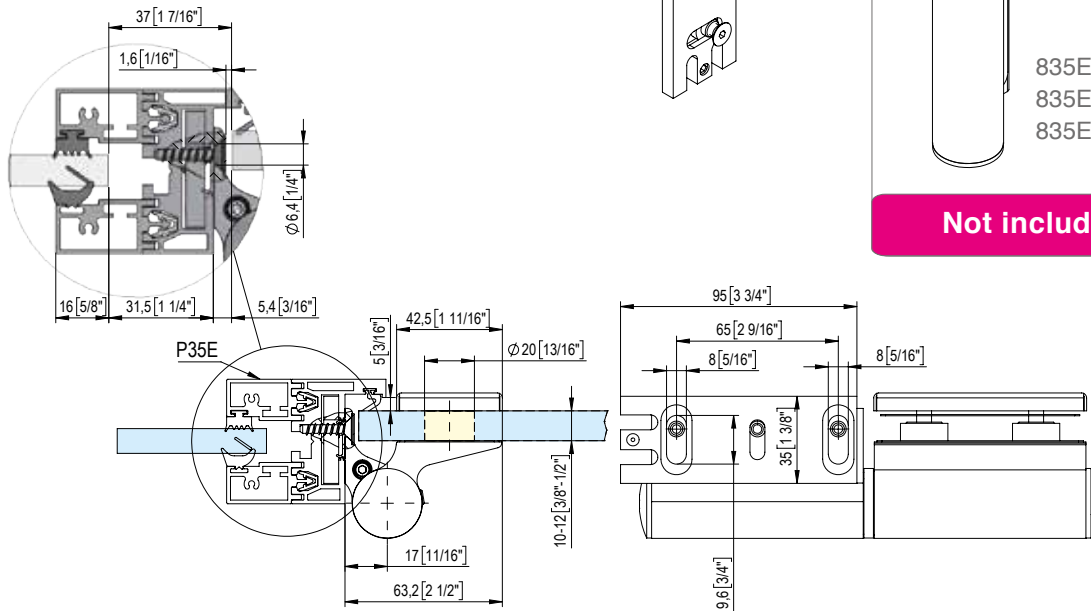

P20E29**P20EC29****2,9m.****P20E58****P20EC58****5,8m.**

- Profilo fermavetro. Spessore 27x25mm. Per vetri 8-13,52mm. Fissaggio pavimento e soffitto.
- Perfil refuerzo. 27x25mm de espesor. Vidrio de 8mm ÷ 13,52mm. Fijación al suelo y el techo.
- Profile for glass fixing. 27x25mm thickness. For 8-13,52mm glass. Floor and ceiling mounting.
- Glasklemmprofil. Abmessungen B=27mm H=25mm. Für Boden- und Deckenbefestigung und Glasdicken 8-13,52mm.
- Profil de renfort. Epaisseur 27x25mm. Pour verre 8-13,52mm. Fixation au sol et fixation murale.

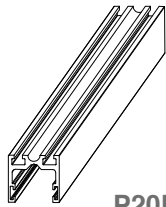
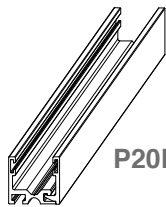
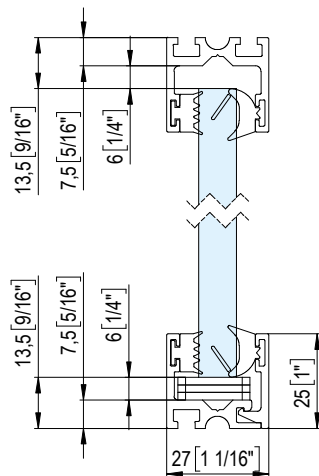
**P20EC29/58****P20E29/58****Compresso / Included**

SPESSORE
ESPOR
THICKNESS
DICKE
ÉPAISSEUR

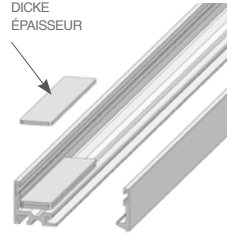

SPessori-ESPESORES
THICKNESSES-DICKEN
ÉPAISSEUR

Compressi nel kit n°6 pezzi ogni metro lineare di profilo
El kit incluye n° 6 piezas de herraje cada metros lineales de perfil
6 pieces per each profile meter are included in the set
Im Set gibt es 6 Stück je Profilmeter
6 pièces pour chaque mètre linéaire de profil sont comprises dans le kit

Guarnizioni da ordinare in base allo spessore del vetro
Gaskets to be purchased according to the glass thickness

**P20EJ0810/6**

Coppia di guarnizioni L=5.8m.
Pareja de guarniciones L=5.8m.
Pair of gaskets L=5.8m.
Paar Dichtungsbänder L=5.8m.
Paire de joints L=5.8m.

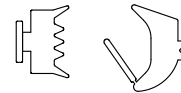
**P20EJ1113/6**

Coppia di guarnizioni L=5.8m.
Pareja de guarniciones L=5.8m.
Pair of gaskets L=5.8m.
Paar Dichtungsbänder L=5.8m.
Paire de joints L=5.8m.

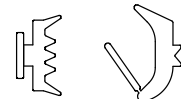
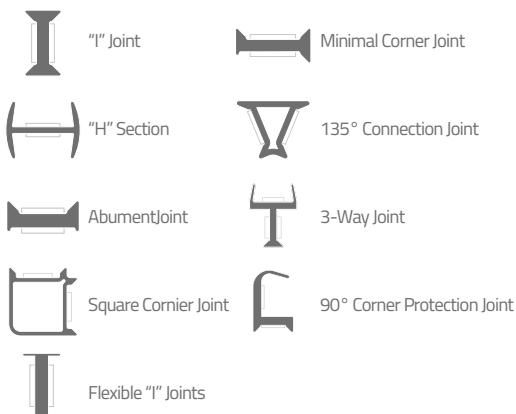
**Non compresso / Not included****Profili guarnizioni / Glass dry joints**

Per maggiori informazioni sulle guarnizioni è possibile vedere la brochure NEW JOINT.

P20EP60

COPPIA DI TAPPI LATERALI spessore 0,5mm
PAREJA DE TAPAS LATERALES espesor 0,5mm
PAIR OF SIDE CAPS thickness 0,5mm
SEITLICHES ENDKAPPENPAAR Dicke 0,5mm
PAIRE DE BOUCHONS LATÉRALES 0,5mm

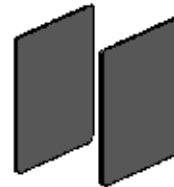
**P20EP61**

SQUADRETTA SUPERIORE DI CONTENIMENTO
PLAQUETA SUPERIOR DE CONTENCIÓN
UPPER CONTAINMENT PLATE
OBERE STÜTZPLATTE
ÉQUERRE SUPÉRIEURE DE CONTENTION

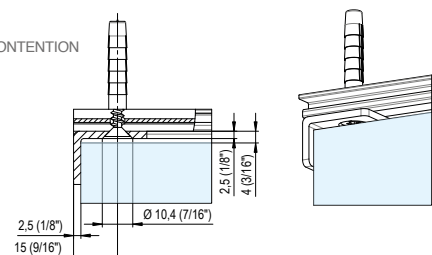
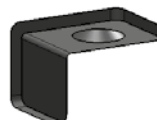

SCHEMA DI DIMENSIONAMENTO (ESEMPIO DI VETRATA CHIUSA)
TAMAÑO – DIAGRAMA (EJEMPLO DE CRISTALERA CERRADA)
SCHEME OF GLASS DIMENSIONING (EXAMPLE WITH CLOSED GLASS)
GLAS ABMESSUNGEN (BEISPIEL FESTVERGLASUNG)

DIMENSIONAMENTO VETRI - EVALUAR LOS VIDRIOS
 GLASS DIMENSIONING - GLAS ABMESSUNGEN

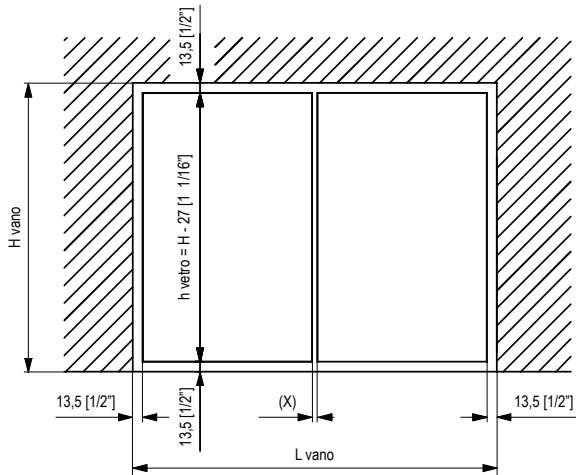

DIMENSIONAMENTO PROFILO FERMAVETRO - EVALUAR EL PERFIL REFUERZO
 DIMENSIONING OF PROFILE - PROFILABMESSUNGEN

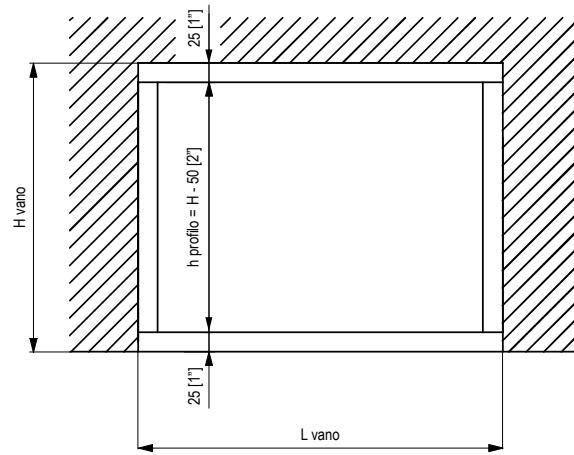

SCHEMA DI DIMENSIONAMENTO (ESEMPIO DI VETRATA APERTA)
TAMAÑO – DIAGRAMA (EJEMPLO DE CRISTALERA ABIERTA)
SCHEME OF GLASS DIMENSIONING (EXAMPLE OF OPEN GLAZING)
GLAS ABMESSUNGEN (BEISPIEL SEITENTEIL MIT TÜR)

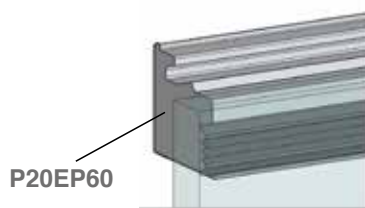

PORTA CON CERNIERE A MURO - PUERTA CON BISAGRA A PARED
 DOOR WITH WALL HINGES - GLAS-WAND BÄNDER

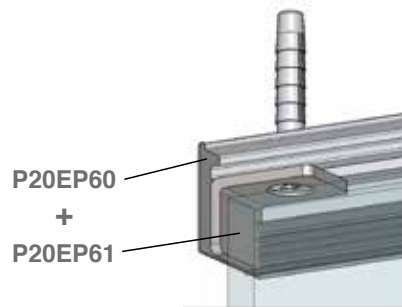
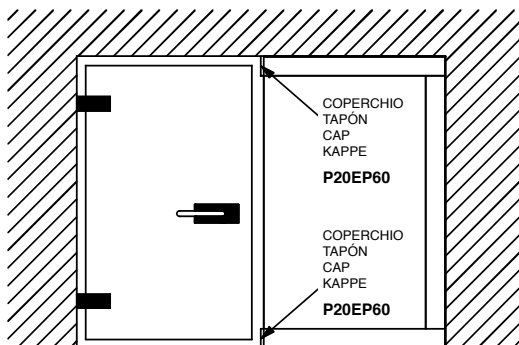

PORTA CON CERNIERE VETRO-VETRO (IL PESO DELLA PORTA GRAVA SUL FISSO)
 PUERTA CON BISAGRA VIDRIO-VIDRIO (EL PESO DE LA PUERTA SOBRE EL VIDRIO FIJO)
 DOOR WITH GLASS-GLASS HINGES (The door weight is beared on the fixed panel)
 GLAS-GLAS BÄNDER (Befestigung an Seitenteil)

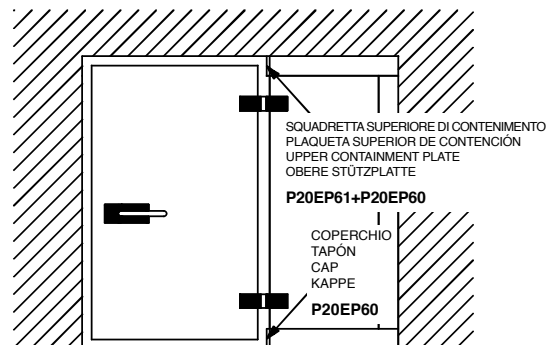

PER INSTALLAZIONI AD ANGOLO - TAGLI A 45°
PARA INSTALACIONES EN ÁNGULO – CORTAR A 45°
FOR CORNER INSTALLATIONS – CUTS AT 45
FÜR DEN EINBAU ÜBER ECK – GEHRUNGSSCHNITT 45°
POUR MONTAGE À ANGLE- COUPE À 45°

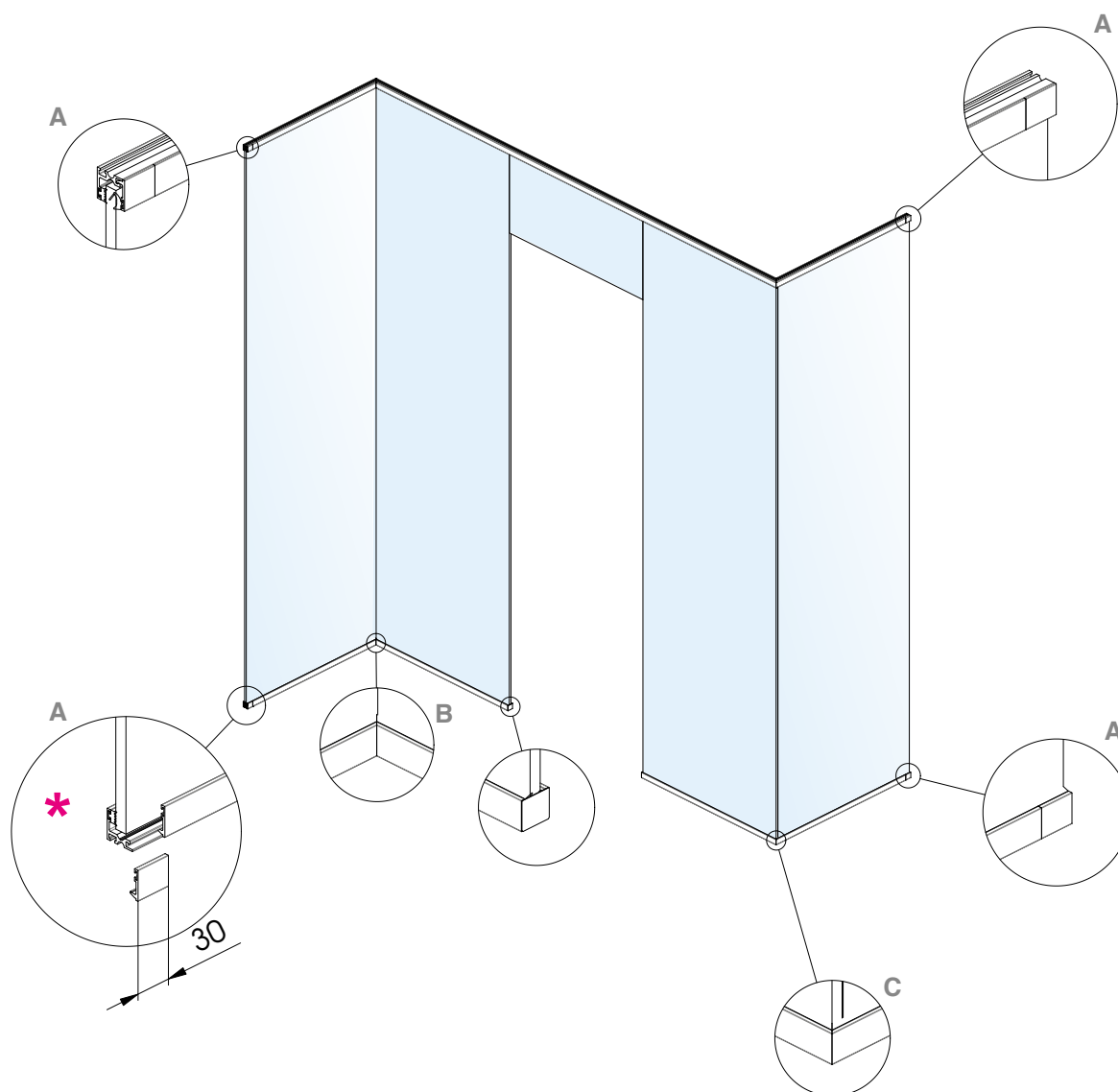

Questa applicazione prevede l'accorciamento e l'inserimento dello spezzone di profilo: vedi dettaglio.

Este tipo de aplicación preve el acortamiento e inserción del fragmento del perfil: vea detalle.

This application entails the shortening and insertion of the profile's part: see detail.

Diese Anwendung erfordert die Kürzung und Einführung des Profilstücks: Siehe Detail.

Cette application prévoit le raccourcissement et l'insertion de la partie de profil: voir détails.

- A** Accorciare il profilo di copertura a 30mm. per permettere il montaggio
 Cortar el perfil de cobertura a 30mm para permitir el montaje
 Cut the covering profile at 30mm in order to allow the assembly
 Das Abdeckprofil bei 30mm schneiden um die Montage zu ermöglichen
 Raccourcir le profil de couverture à 30 mm pour permettre le montage
- B** Coperchio montato all'interno dell'angolo
 Tapa montada en el interior del ángulo
 Cover mounted inside the corner
 Abdeckblech innenseitig aufklipsen
 Couvercle monté à l'intérieur de l'angle
- C** Coperchio montato all'esterno dell'angolo
 Tapa montada en el exterior del ángulo
 Cover mounted outside the corner
 Abdeckblech außenseitig aufklipsen
 Couvercle monté à l'extérieur de l'angle

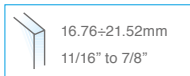
P25E29**P25EC29****2,9m.****P25E58****P25EC58****5,8m.**

• Profilo fermavetro. Spessore 38x35mm. Per vetri 16.76÷21.52mm. Fissaggio pavimento e soffitto.

• Perfil refuerzo. 38x35mm de espesor. Vidrio de 16.76÷21.52mm. Fijación al suelo y el techo.

• Profile for glass fixing. 38x35mm thickness. For 16.76÷21.52mm glass. Floor and ceiling mounting.

• Glasklemmprofil. Abmessungen B=38mm H=35mm. Für Boden- und Deckenbefestigung und Glasdicken 16.76÷21.52mm.

• Profil de renfort. Epaisseur 38x35mm. Pour verre 16.76÷21.52mm. Fixation au sol et fixation murale.

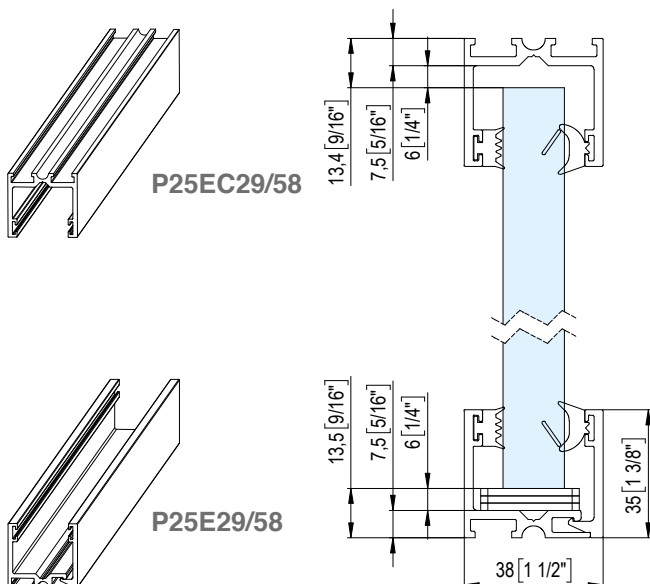
**Compresso / Included**

SPESSORE
ESPESOR
THICKNESS
DICKE
ÉPAISSEUR

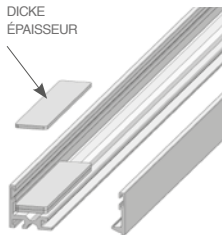

SPessori-ESPESORES
THICKNESSES-DICKEN
ÉPAISSEUR

Compresi nel kit n°6 pezzi ogni metro lineare di profilo

El kit incluye n° 6 piezas de herraje cada metros lineales de perfil

6 pieces per each profile meter are included in the set

Im Set gibt es 6 Stück je Profilmeter

6 pièces pour chaque mètre linéaire de profil sont comprises dans le kit

Guarnizioni da ordinare in base allo spessore del vetro
Gaskets to be purchased according to the glass thickness

**P20EJ0810/6**

Coppia di guarnizioni L=5.8m.
Pareja de guarniciones L=5.8m.
Pair of gaskets L=5.8m.
Paar Dichtungsbänder L=5.8m.
Paire de joints L= 5.8m.

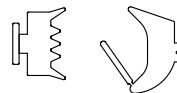
**P20EJ1113/6**

Coppia di guarnizioni L=5.8m.
Pareja de guarniciones L=5.8m.
Pair of gaskets L=5.8m.
Paar Dichtungsbänder L=5.8m.
Paire de joints L= 5.8m.

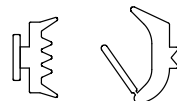
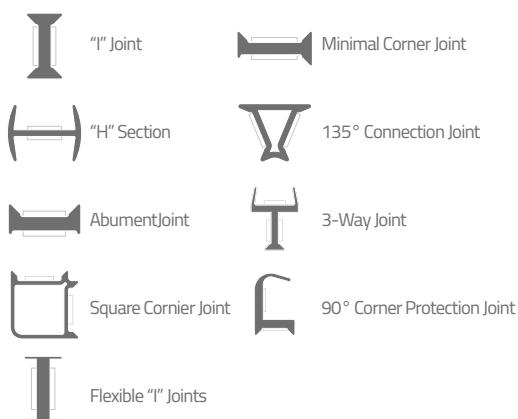
**Non compreso / Not included****Profili guarnizioni / Glass dry joints**

Per maggiori informazioni sulle guarnizioni è possibile vedere la brochure NEW JOINT - For more information on these seals, see the NEW JOINT brochure

P25EP60

COPPIA DI TAPPI LATERALI spessore 0,5mm
PAREJA DE TAPAS LATERALES espesor 0,5mm
PAIR OF SIDE CAPS thickness 0,5mm
SEITLICHES ENDKAPPENPAAR Dicke 0,5mm
PAIRE DE BOUCHONS LATÉRALES 0,5mm

**P20EP61**

SQUADRETTA SUPERIORE DI CONTENIMENTO
PLAQUETA SUPERIOR DE CONTENCIÓN
UPPER CONTAINMENT PLATE
OBERE STÜTZPLATTE
ÉQUERRE SUPÉRIEURE DE CONTENTION

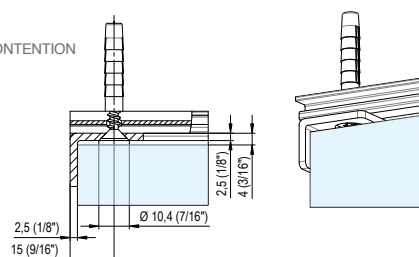
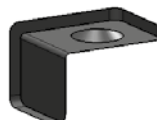

SCHEMA DI DIMENSIONAMENTO (ESEMPIO DI VETRATA CHIUSA)

TAMAÑO – DIAGRAMA (EJEMPLO DE CRISTALERA CERRADA)
 SCHEME OF GLASS DIMENSIONING (EXAMPLE WITH CLOSED GLASS)
 GLAS ABMESSUNGEN (BEISPIEL FESTVERGLASUNG)

DIMENSIONAMENTO VETRI - EVALUAR LOS VIDRIOS
 GLASS DIMENSIONING - GLAS ABMESSUNGEN

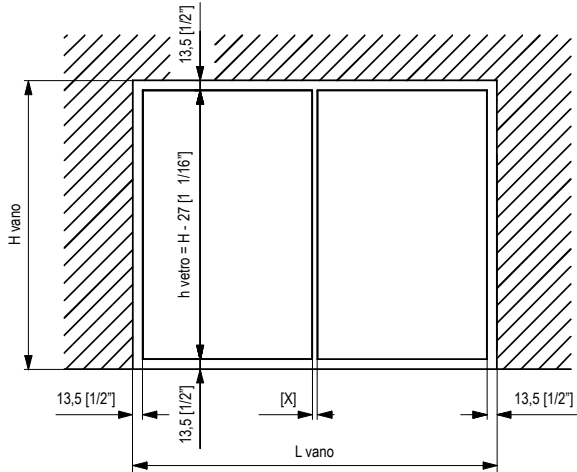

DIMENSIONAMENTO PROFILO FERMAVETRO - EVALUAR EL PERFIL REFUERZO
 DIMENSIONING OF PROFILE - PROFILABMESSUNGEN

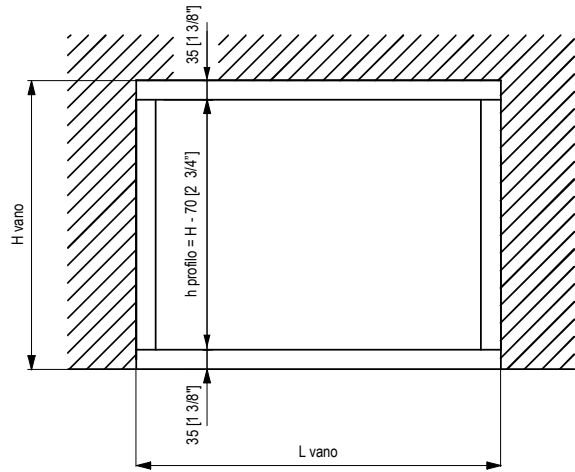

SCHEMA DI DIMENSIONAMENTO (ESEMPIO DI VETRATA APERTA)

TAMAÑO – DIAGRAMA (EJEMPLO DE CRISTALERA ABIERTA)
 SCHEME OF GLASS DIMENSIONING (EXAMPLE OF OPEN GLAZING)
 GLAS ABMESSUNGEN (BEISPIEL SEITENTEIL MIT TÜR)

P25EP60



P25EP60

+

P25EP61

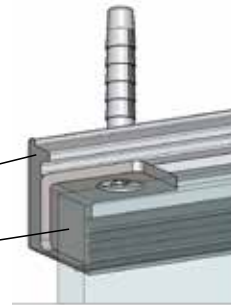

PORTA CON CERNIERE A MURO - PUERTA CON BISAGRA A PARED
 DOOR WITH WALL HINGES - GLAS-WAND BÄNDER

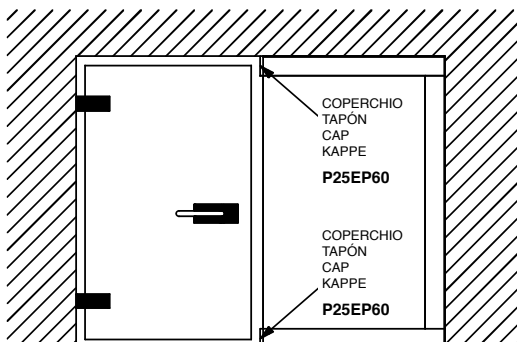

PORTA CON CERNIERE VETRO-VETRO (IL PESO DELLA PORTA GRAVA SUL FISSO)
 PUERTA CON BISAGRA VIDRIO-VIDRIO (EL PESO DE LA PUERTA SOBRE EL VIDRIO FIJO)
 DOOR WITH GLASS-GLASS HINGES (The door weight is beard on the fixed panel)
 GLAS-GLAS BÄNDER (Befestigung an Seitenteil)

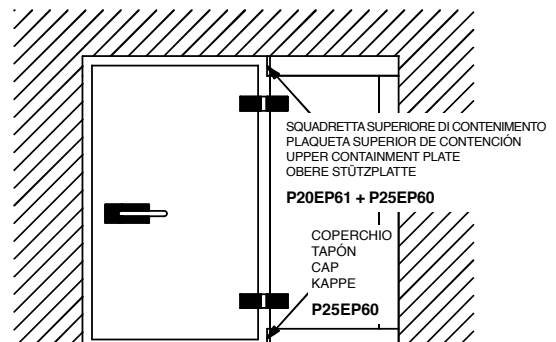

PER INSTALLAZIONI AD ANGOLO - TAGLI A 45°
PARA INSTALACIONES EN ÁNGULO – CORTAR A 45°
FOR CORNER INSTALLATIONS – CUTS AT 45
FÜR DEN EINBAU ÜBER ECK – GEHRUNGSSCHNITT 45°
POUR MONTAGE À ANGLE- COUPE À 45°

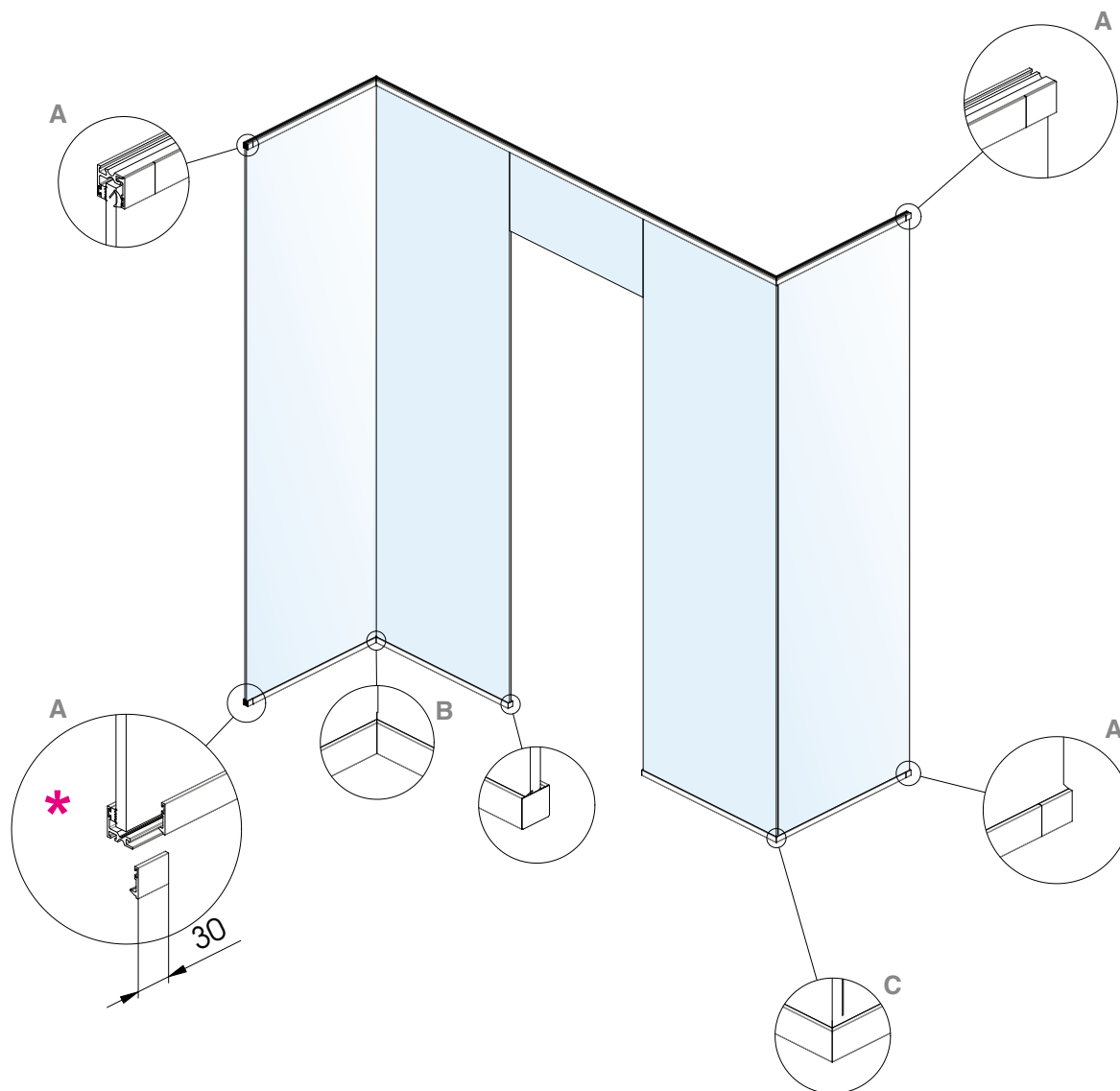

Questa applicazione prevede l'accorciamento e l'inserimento dello spezzone di profilo: vedi dettaglio.

Este tipo de aplicación preve el acortamiento e inserción del fragmento del perfil: vea detalle.

This application entails the shortening and insertion of the profile's part: see detail.

Diese Anwendung erfordert die Kürzung und Einführung des Profilstücks: Siehe Detail.

Cette application prévoit le raccourcissement et l'insertion de la partie de profil: voir détails.

- A** Accorciare il profilo di copertura a 30mm. per permettere il montaggio
 Cortar el perfil de cobertura a 30mm para permitir el montaje
 Cut the covering profile at 30mm in order to allow the assembly
 Das Abdeckprofil bei 30mm schneiden um die Montage zu ermöglichen
 Raccourcir le profil de couverture à 30 mm pour permettre le montage
- B** Coperchio montato all'interno dell'angolo
 Tapa montada en el interior del ángulo
 Cover mounted inside the corner
 Abdeckblech innenseitig aufklipsen
 Couvercle monté à l'intérieur de l'angle
- C** Coperchio montato all'esterno dell'angolo
 Tapa montada en el exterior del ángulo
 Cover mounted outside the corner
 Abdeckblech außenseitig aufklipsen
 Couvercle monté à l'extérieur de l'angle

profili / profiles

system **P20E**

Alluminio / Aluminium - finiture / colors 02-05-13

P20E è un profilo in alluminio che consente di creare cornici essenziali per pareti continue in vetro temperato e stratificato. E' adatto per applicazioni in uffici ed abitazioni in quanto permette di suddividere facilmente gli ambienti mantenendo intatta la luminosità.

Questa canalina fermavetro, dalla forma estremamente ridotta, in soli 25 mm di altezza con una larghezza di 27 mm consente di installare vetri da 8 fino a 13,52 mm. Un unico profilo e due kit di guarnizioni: uno per vetri da 8-10,76 mm e uno per vetri da 11,52-13,52 mm.

Il formato ed il design minimale favoriscono la posa di pareti divisorie in tempi estremamente rapidi. P20E è disponibile nella finitura alluminio ossidato naturale e simil inox satinato, in lunghezze di 2,9 metri e 5,8 metri. Ottimo il rapporto qualità prezzo.

P20E es en perfil en aluminio, que permite crear marcos lineales para particiones de vidrio templado y laminado. Apto para aplicaciones en oficinas y habitaciones privadas, como divide los espacios fácilmente, pero manteniendo la luminosidad original.

Este perfil fijador, con su forma extremadamente reducida y con solo 25mm de altura y 27mm de ancho, permite instalar vidrios de 8mm a 13,52mm de espesor. El perfil es único, y se combina con dos kits de guarniciones: uno para vidrios 8-10,76 y otro para vidrios 11,52-13,52.

La forma y el design minimales favorecen y aceleran la instalación de las particiones. P20E es disponible en dos acabados: aluminio natural e imitación acero satinado – y en dos medidas: 2,9 mt y 5,8 mt. Óptima la relación calidad/precio.

P20E is the aluminum profile which allows you to realize basic frames for continuous walls made of tempered and laminated glass. Suitable for offices and private rooms, since it easily divides the space but shielding the area's luminosity.

This profile for glass fixation has an extremely reduced shape and, with only 25mm height and 27mm width, can fit glasses from 8mm up to 13,52mm thickness. Only one profile which can be combined with

two different gaskets' kits: one for glass 8-10,76mm and one for glass 11,52-13,52mm. The minimal shape and design facilitates and speeds the continuous walls' dregs. P20E is available in two finishes: clear anodized aluminum and imitation satin stainless steel – and in two lengths: 2,9 mt and 5,8 mt. Great price/quality ratio.

P20E ist das Glasklemmprofil mit Klippverbindung in Aluminium für Trennwände aus Glas, ESG oder VSG. Das Profil ist einsetzbar in Büroräumen oder im privaten Bereich, und ermöglicht Räume zu trennen und die Transparenz zu erhalten.

Mit nur 25mm Höhe und einer Breite von 27mm, ist dieses schmale Profil für Glasdicken von 8-13,52mm geeignet. Ein Profil mit zwei Dichtungssets: eins für Glasdicken 8-10,76mm und ein Set für Glasdicken 11,52-13,52mm.

Die Form und das Design ermöglichen eine einfache und schnelle Montage von Trennwänden mittels Klippverbindungen. P20E ist in den Oberflächen EV1 und Niro ähnlich, in den Längen 2,90 Meter und 5,80 Meter verfügbar und bieten ein optimales Preis-Leistung Verhältnis.

P20E est le profil en aluminium qui permet la création de cadres pour les cloisons continues en verre trempé et feuilleté. Il est parfaitement adapté aux applications pour les bureaux et habitations privées car il permet de diviser les espaces et d'en conserver la luminosité.

Cette parclose, de forme extrêmement réduite, avec seulement 25 mm de hauteur et une largeur de 27mm, permet d'installer des panneaux de verre de 8 à 13,52 mm. Un profil unique et deux kits de joints possibles : un pour les verres de 8-10,76 mm et un pour les verres de 11,52-13,52 mm.

La taille et le design minimaliste favorisent l'installation de profil dans un temps extrêmement réduit. P20E est disponible en finition aluminium anodisé naturel ou inox satiné, en longueur de 2,9 m et 5,8 m. Rapport qualité-prix optimal.



P20E29**2,9m.****P20E58****5,8m.**

- Profilo fermavetro. Spessore 27x25mm. Per vetri 8÷13,52mm. Fissaggio pavimento e soffitto.
- Perfil refuerzo. 27x25mm de espesor. Vidrio de 8mm ÷ 13,52mm. Fijación al suelo y el techo.
- Profile for glass fixing. 27x25mm thickness. For 8÷13,52mm glass. Floor and ceiling mounting.
- Glasklemmprofil. Abmessungen B=27mm H=25mm. Für Boden- und Deckenbefestigung und Glasdicken 8-13,52mm.
- Profil de renfort. Epaisseur 27x25mm. Pour verre 8÷13,52mm. Fixation au sol et fixation murale.

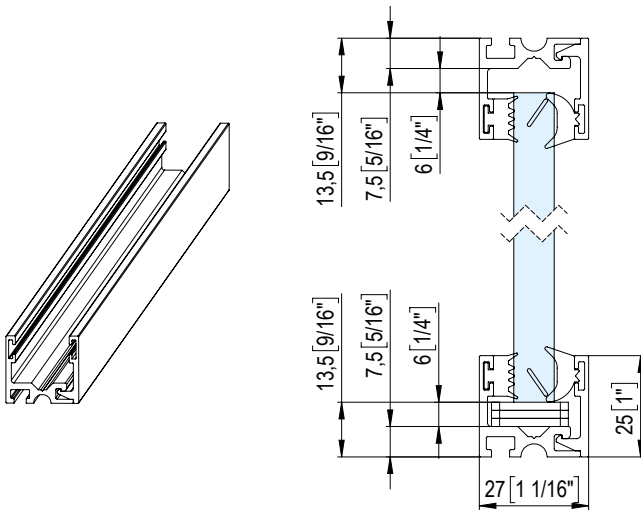
**Compresso / Included**

SPESSORE
ESPOR
THICKNESS
DICKE
ÉPAISSEUR

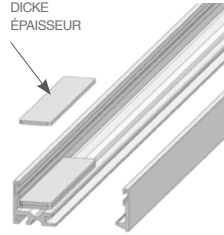

SPessori-ESPEORES
THICKNESSES-DICKEN
ÉPAISSEUR

Compresi nel kit n°6 pezzi ogni metro lineare di profilo
El kit incluye n° 6 piezas de herraje cada metros lineales de perfil
6 pieces per each profile meter are included in the set
Im Set gibt es 6 Stück je Profilmeter
6 pièces pour chaque mètre linéaire de profil sont comprises dans le kit

Guarnizioni da ordinare in base allo spessore del vetro
Gaskets to be purchased according to the glass thickness

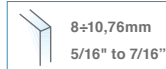
**P20EJ0810/6**

Coppia di guarnizioni L=5,8m.
Pareja de guarniciones L=5,8m.
Pair of gaskets L=5,8m.
Paar Dichtungsbänder L=5,8m.
Paire de joints L= 5,8m.

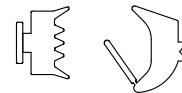
**P20EJ1113/6**

Coppia di guarnizioni L=5,8m.
Pareja de guarniciones L=5,8m.
Pair of gaskets L=5,8m.
Paar Dichtungsbänder L=5,8m.
Paire de joints L= 5,8m.

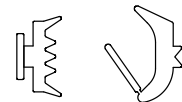
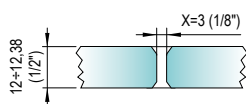
**Non compreso / Not included****PCC18**

Profilo in policarbonato
Perfil en policarbonato
Polycarbonate profile
Profil aus Polycarbonat
Profil en polycarbonate

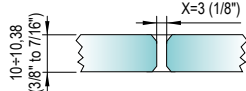
**PCC14**

Profilo in policarbonato
Perfil en policarbonato
Polycarbonate profile
Profil aus Polycarbonat
Profil en polycarbonate

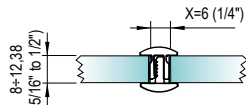
**PCC17**

Profilo in alluminio
Perfil en aluminio
Anodized aluminium profile
Profil aus eloxiertem Aluminium
Profil en aluminium

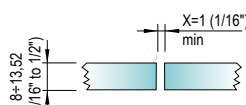

Senza profilo
Sin perfil
Without profile
Ohne Profil
Sans profil

Siliconare - Aplicar silicona
Use silicone - Silikon verwenden
Utilisez silicone

P20EP60

COPIA DI TAPPI LATERALI spessore 0,5mm
PAREJA DE TAPAS LATERALES espesor 0,5mm
PAIR OF SIDE CAPS thickness 0,5mm
SEITLICHES ENDKAPPENPAAR Dicke 0,5mm
PAIRE DE BOUCHONS LATÉRALES 0,5mm

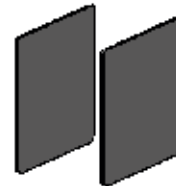
**P20EP61**

SQUADRETTA SUPERIORE DI CONTENIMENTO
PLAQUETA SUPERIOR DE CONTENCIÓN
UPPER CONTAINMENT PLATE
OBERE STÜTZPLATTE
ÉQUERRE SUPÉRIEURE DE CONTENION

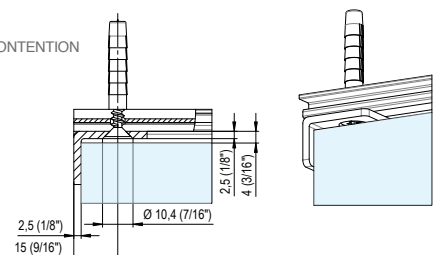
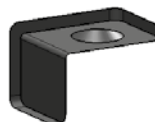

SCHEMA DI DIMENSIONAMENTO (ESEMPIO DI VETRATA CHIUSA)
TAMAÑO – DIAGRAMA (EJEMPLO DE CRISTALERA CERRADA)
SCHEME OF GLASS DIMENSIONING (EXAMPLE WITH CLOSED GLASS)
GLAS ABMESSUNGEN (BEISPIEL FESTVERGLASUNG)

DIMENSIONAMENTO VETRI - EVALUAR LOS VIDRIOS
 GLASS DIMENSIONING - GLAS ABMESSUNGEN

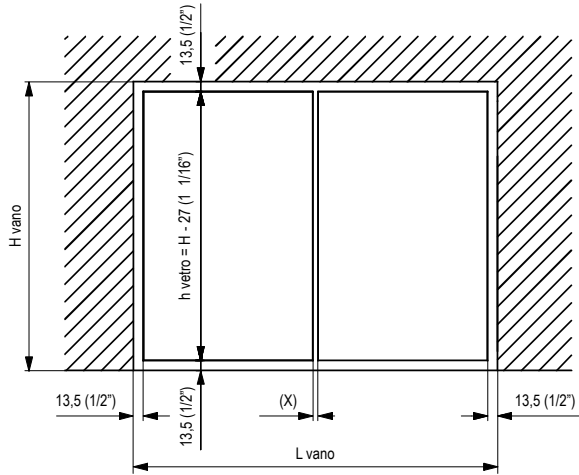

DIMENSIONAMENTO PROFILO FERMAVETRO - EVALUAR EL PERFIL REFUERZO
 DIMENSIONING OF PROFILE - PROFILABMESSUNGEN

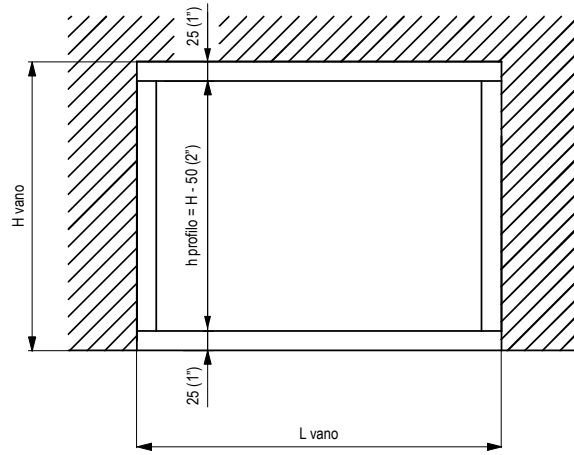

SCHEMA DI DIMENSIONAMENTO (ESEMPIO DI VETRATA APERTA)
TAMAÑO – DIAGRAMA (EJEMPLO DE CRISTALERA ABIERTA)
SCHEME OF GLASS DIMENSIONING (EXAMPLE OF OPEN GLAZING)
GLAS ABMESSUNGEN (BEISPIEL SEITENTEIL MIT TÜR)

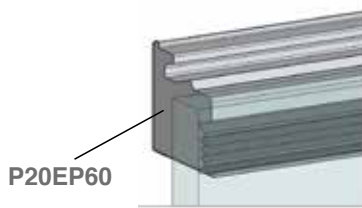

PORTA CON CERNIERE A MURO - PUERTA CON BISAGRA A PARED
 DOOR WITH WALL HINGES - GLAS-WAND BÄNDER

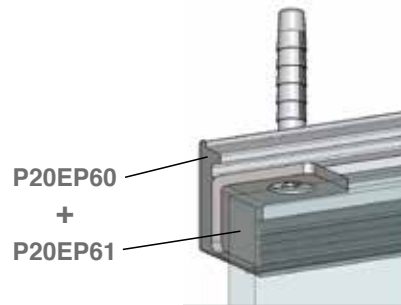
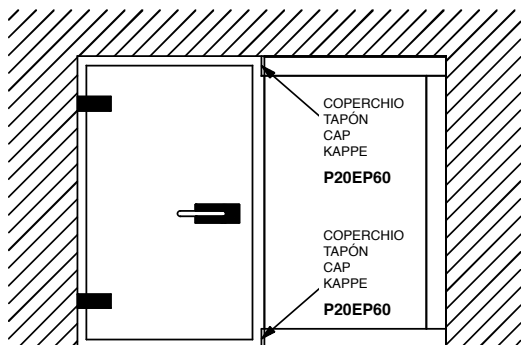

PORTA CON CERNIERE VETRO-VETRO (IL PESO DELLA PORTA GRAVA SUL FISSO)
 PUERTA CON BISAGRA VIDRIO-VIDRIO (EL PESO DE LA PUERTA SOBRE EL VIDRIO FIJO)
 DOOR WITH GLASS-GLASS HINGES (The door weight is beared on the fixed panel)
 GLAS-GLAS BÄNDER (Befestigung an Seitenteil)

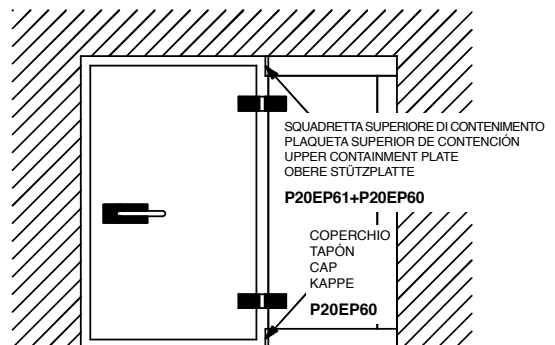

PER INSTALLAZIONI AD ANGOLO - TAGLI A 45°
PARA INSTALACIONES EN ÁNGULO – CORTAR A 45°
FOR CORNER INSTALLATIONS – CUTS AT 45
FÜR DEN EINBAU ÜBER ECK – GEHRUNGSSCHNITT 45°
POUR MONTAGE À ANGLE- COUPE À 45°

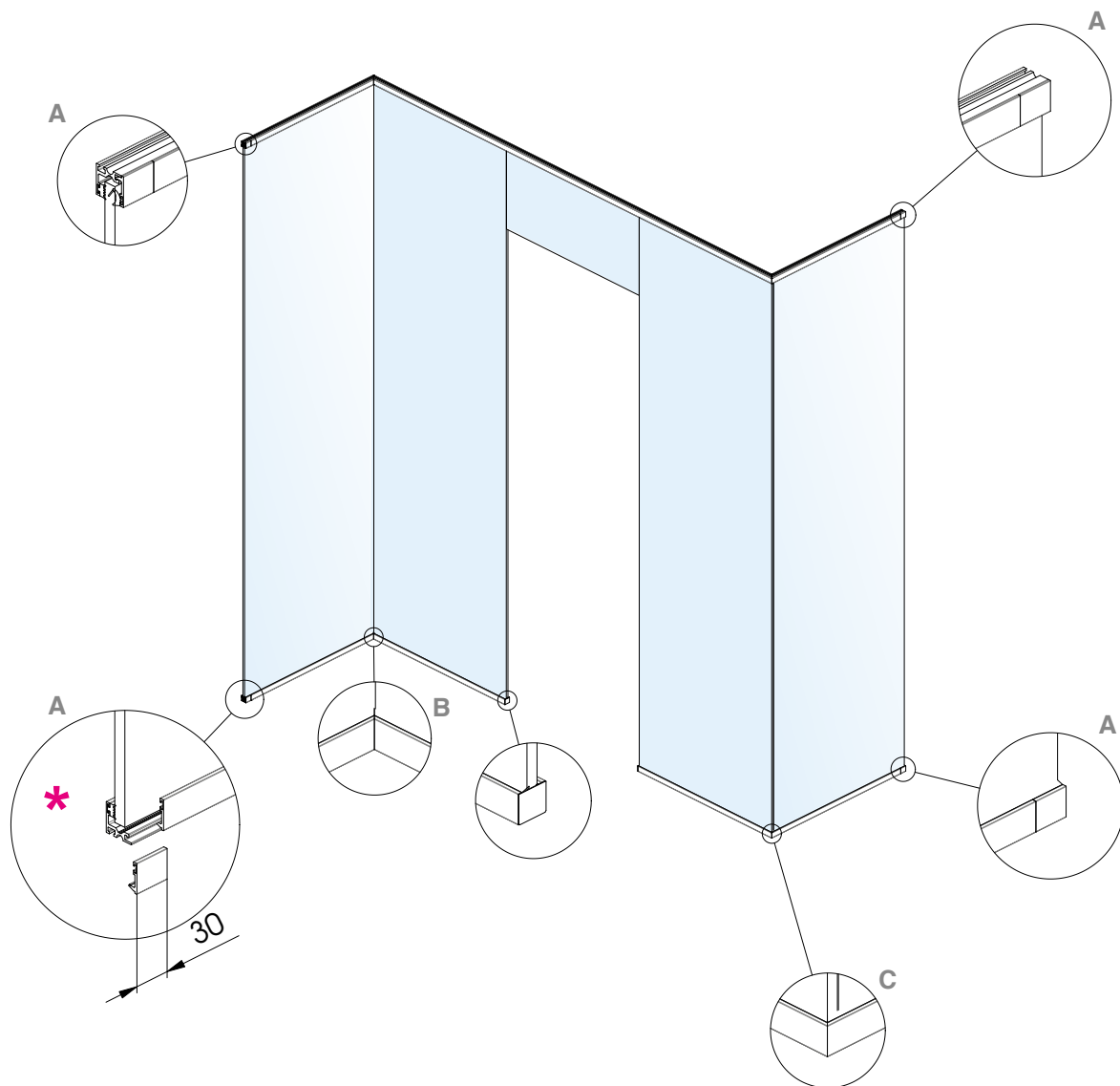

Questa applicazione prevede l'accorciamento e l'inserimento dello spezzone di profilo: vedi dettaglio.

Este tipo de aplicación preve el acortamiento e inserción del fragmento del perfil: vea detalle.

This application entails the shortening and insertion of the profile's part: see detail.

Diese Anwendung erfordert die Kürzung und Einführung des Profilstücks: Siehe Detail.

Cette application prévoit le raccourcissement et l'insertion de la partie de profil: voir détails.

- A** Accorciare il profilo di copertura a 30mm. per permettere il montaggio
 Cortar el perfil de cobertura a 30mm para permitir el montaje
 Cut the covering profile at 30mm in order to allow the assembly
 Das Abdeckprofil bei 30mm schneiden um die Montage zu ermöglichen
 Raccourcir le profil de couverture à 30 mm pour permettre le montage
- B** Coperchio montato all'interno dell'angolo
 Tapa montada en el interior del angulo
 Cover mounted inside the corner
 Abdeckblech innenseitig aufklipsen
 Couvercle monté à l'intérieur de l'angle
- C** Coperchio montato all'esterno dell'angolo
 Tapa montada en el exterior del angulo
 Cover mounted outside the corner
 Abdeckblech außenseitig aufklipsen
 Couvercle monté à l'extérieur de l'angle

profili / profiles

system P30W

Alluminio / Aluminium - finiture / colors 02-05-13

STRIQE è il profilo in alluminio per porte in battuta. E' la soluzione ideale per creare cornici essenziali ad ingressi in muratura e pareti in vetro. E' perfettamente abbinabile al profilo per pareti divisorie P20E, alle cerniere e serrature di Colcom.
STRIQE è fornito in barre da 5800mm di lunghezza ed è disponibile nelle finiture alluminio naturale e simil inox satinato.

STRIQE es el perfil en aluminio para puertas con tope. Es la solución ideal para realizar una estructura esencial para accesos de labril y paredes en vidrio. También se adapta perfectamente al perfil Colcom P20E para tabiques.
STRIQE se vende en barras largas 5800mm con acabado aluminio natural y simil acero satinado. Se empareja perfectamente con bisagras y cerraduras Colcom.

STRIQE is our aluminium profile for single action doors. It's the ideal solution to create a basic doorframe or a glass partition doorframe. It's designed to combine perfectly with Colcom's P20E profile to create complete office partitions.

STRIQE is available in lengths of 5800mm and is offered in aluminium natural anodized finish and in satin stainless steel effect, furthermore it's possible to integrate a nice selection of Colcom lock's and hinges.

STRIQE ist unserem Aluminiumprofil für Anschlagtüren. Es ist die ideale Lösung um einen Falzrahmen im Bereich von Maueröffnungen bzw. Glastrennwänden auszuführen. Diese Lösung passt Profilsystem P20E von Colcom und ist damit perfekt kombinierbar.
STRIQE ist einer Profillänge von 5800mm und ist in den Oberflächen Aluminium EV1 oder Edelstahl ähnlich lieferbar. Beschläge und Schösser von Colcom sind auf dieses Profil abgestimmt.

STRIQE est un profil en aluminium pour portes avec butée. C'est une solution idéale pour créer des encadrements de portes simples sur murs ou sur parois en verre. Il a été conçu pour s'associer parfaitement avec le profil pour cloisons P20E de Colcom.
STRIQE est fourni en barres de 5800mm de longueur et disponible avec les finitions en aluminium naturel et imitation inox satiné. Il peut parfaitement être couplé avec les charnières et serrures Colcom.



P30W58

5,8m.

STRIQE



- Profilo telaio per porte in vetro. Per vetri porta di 10-12mm. Fissaggio a muro o su vetro.
- Perfil marco para puertas en vidrio. Sujeta vidrios de 10-12mm. Fijación a pared o a vidrio.
- Profile for 10-12mm glass doors. Mountable on standard walls or glass.
- Zargenprofil für Glstüren. Glasdicke von 10 bis 12mm. Befestigung an der Mauer oder am Glas.
- Profil pour portes en verre de 10-12 mm. Fixation sur mur ou sur verre.

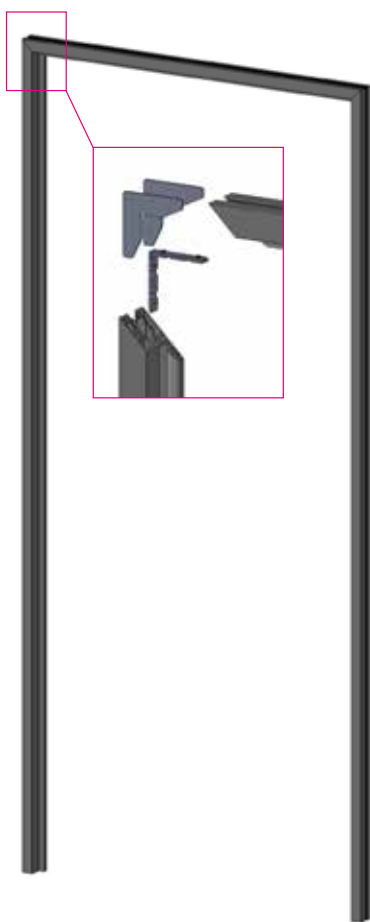

Fissaggio a muro / Wall fixing

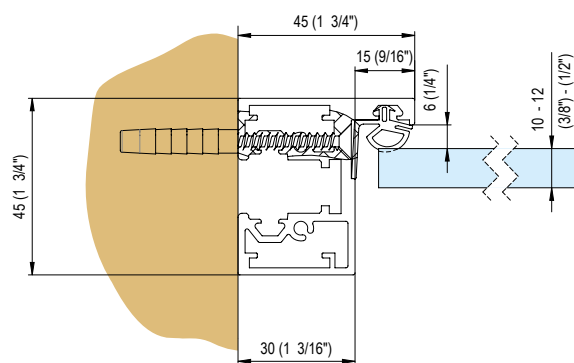

Fissaggio a vetro / Glass fixing

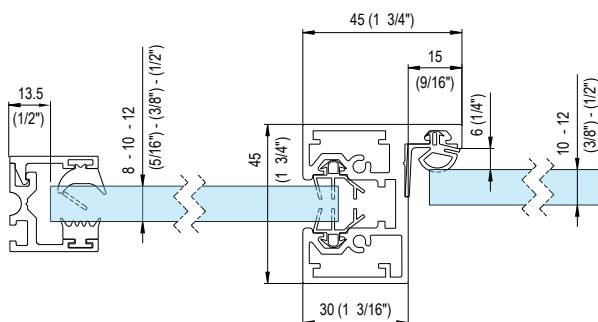

Guarnizioni per fissaggio a vetro da ordinare in base allo spessore del vetro
Gaskets for glass fixing to be purchased according to the glass thickness

KJP30W10



Coppia di guarnizioni L=5,8m.
Pareja de guarniciones L=5,8m.
Pair of gaskets L=5,8m.
Paar Dichtungsbänder L=5,8m.
Paire de garniture L= 5,8 m.



KJP30W12



Coppia di guarnizioni L=5,8m.
Pareja de guarniciones L=5,8m.
Pair of gaskets L=5,8m.
Paar Dichtungsbänder L=5,8m.
Paire de garniture L= 5,8 m.



Compreso / Included

P30WP21 (x4)

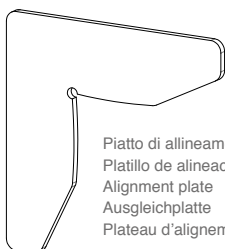

Piatto di allineamento
Platillo de alineación
Alignment plate
Ausgleichplatte
Plateau d'alignement

P30WP22 (x2)

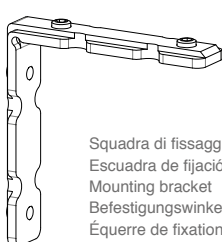

Squadra di fissaggio
Escuadra de fijación
Mounting bracket
Befestigungswinkel
Équerre de fixation

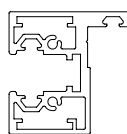

P30WP40/58 (x1)

Profilo battuta L 5800mm
Perfil para jamba L=5800mm
Profile for doors with rebate, length: 5800mm
Profil für Türen mit Stop L=5800mm
Profil en butée L=5800mm



P30WJ01/58 (x1)

Guarnizione per porta L 5800mm
Sellar para puertas L=5800mm
Seal for door, length: 5800mm
Türdichtung für Seitenteil Befestigung L=5800mm
Joints pour porte L= 5800 mm

Non compreso / Not included

P20E

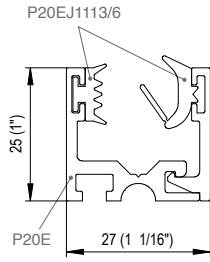
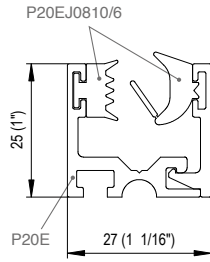
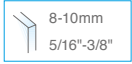
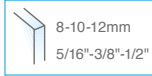

0P30W

Piastrina regolabile per profilo P30W
 Platinilla ajustable para perfil P30W
 Adjustable plate for P30W profile
 Schließblech regulierbar für das Profil P30W
 Plaquette réglable pour profil P30W

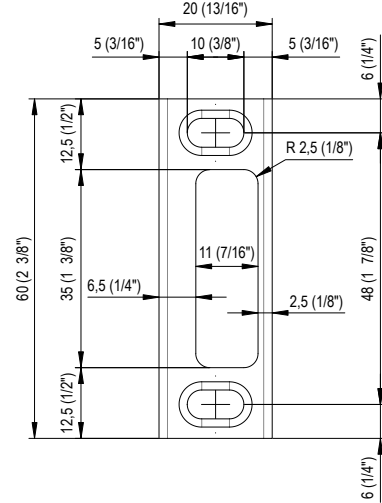

P30WP90

Elemento di collegamento con P20E
 Pieza de conexión con P20E
 Link with P20E
 Verbindungselement passend zu P20E
 Élément de raccord avec P20E

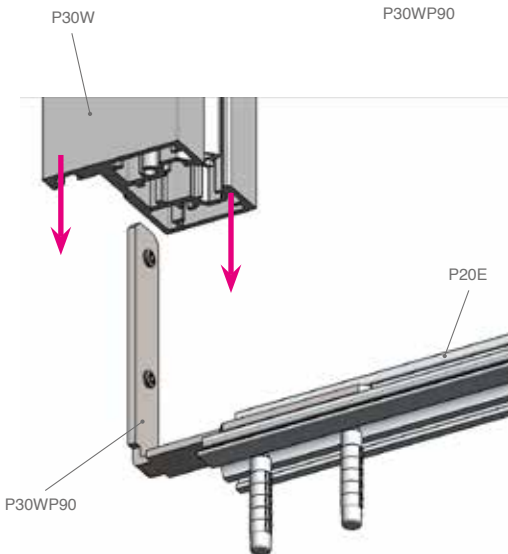
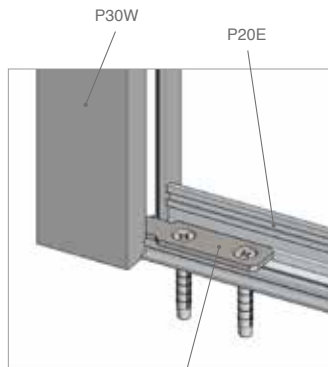

Flexa series



0P30W



LOQ series



0P30W



622E10



0622E12



620E10

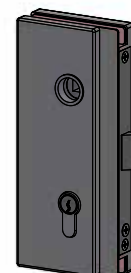

0P30W



8664P

STRIQE

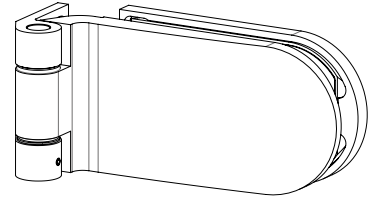
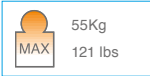
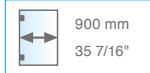

- Cerniera laterale tonda per profilo P30W.
- Bisagra lateral redonda para perfil P30W.
- Round side hinge for P30W profile.
- Seitliches Band in Rundform passend zu Profil P30W.
- Charnière latérale ronde pour profil P30W

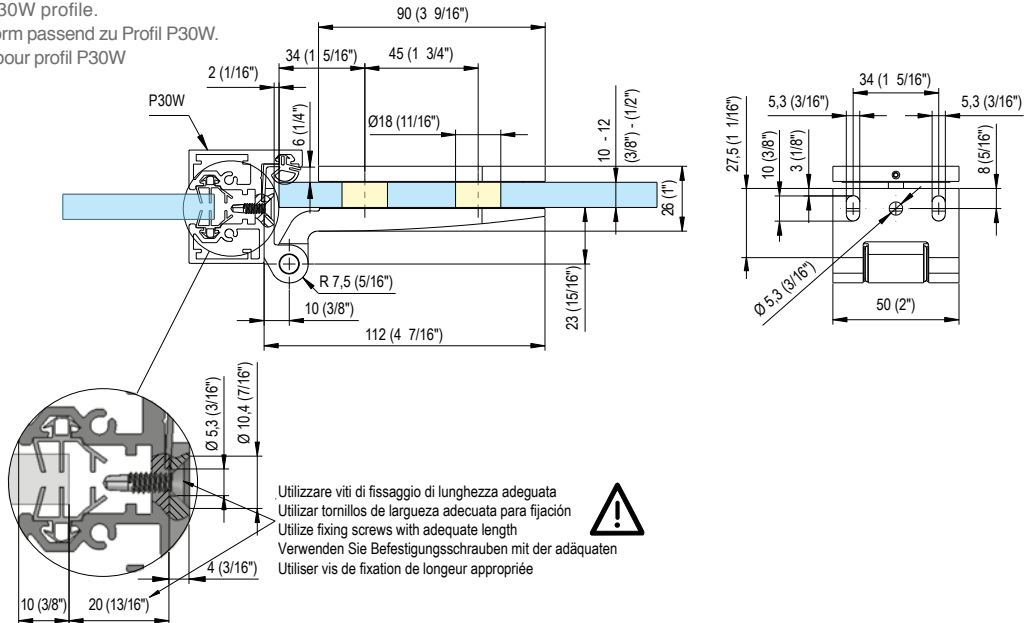

8665P

STRIQE

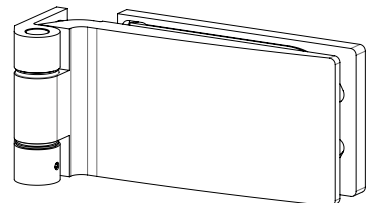
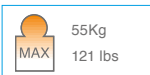
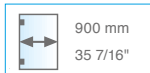

- Cerniera laterale per profilo P30W.
- Bisagra lateral para perfil P30W.
- Round side hinge for P30W profile.
- Seitliches Band in Eckform passend zu ProfilP30W.
- Charnière latérale pour profil P30W

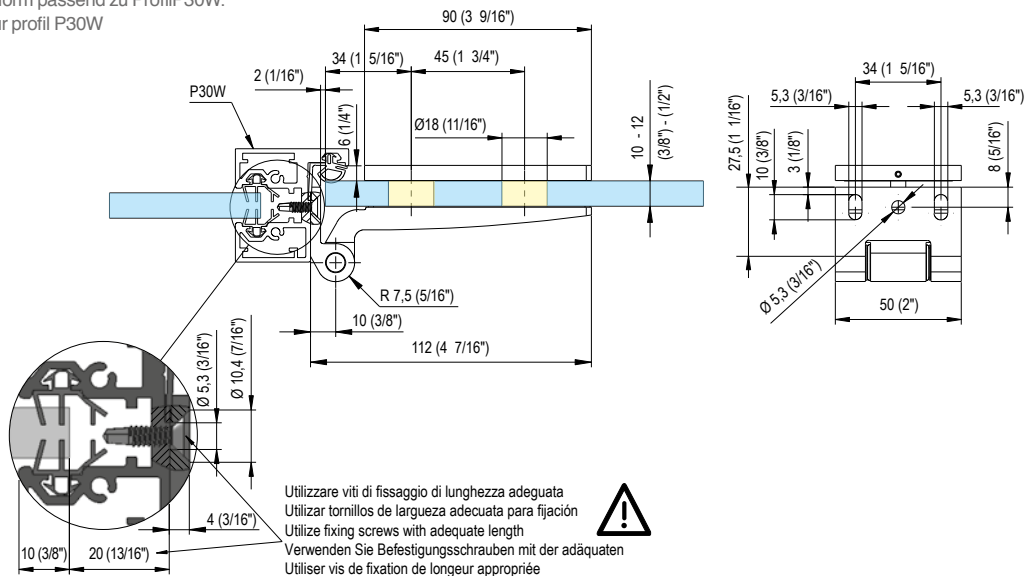

8810P

STRIQE

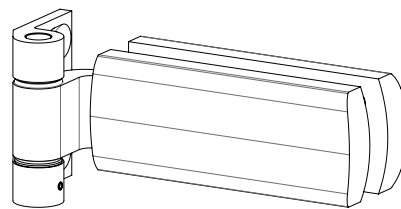
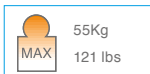
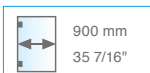

- Cerniera laterale FLEXA per profilo P30W.
- Bisagra lateral Flexa para perfil P30W.
- Round hinge FLEXA for P30W profile.
- Seitlicher Band FLEXA passend zu Profil P30W.
- Charnière latérale FLEXA pour profil P30W.

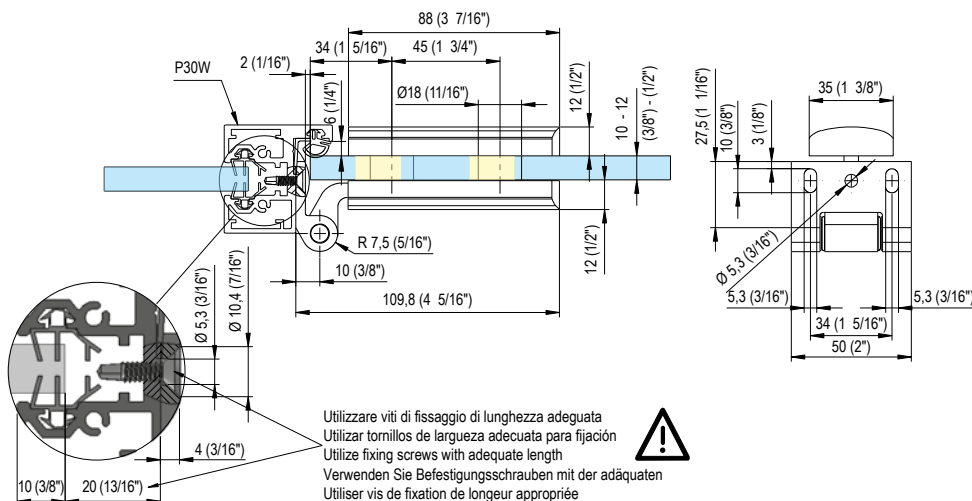

8674P

STRIQE

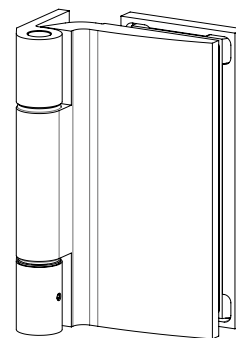
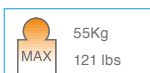
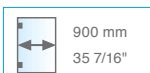

- Cerniera laterale per profilo P30W.
- Bisagra lateral para perfil P30W.
- Round side hinge for P30W profile.
- Seitliches vertikales Band zu P30W.
- Charnière latérale pour profil P30W.

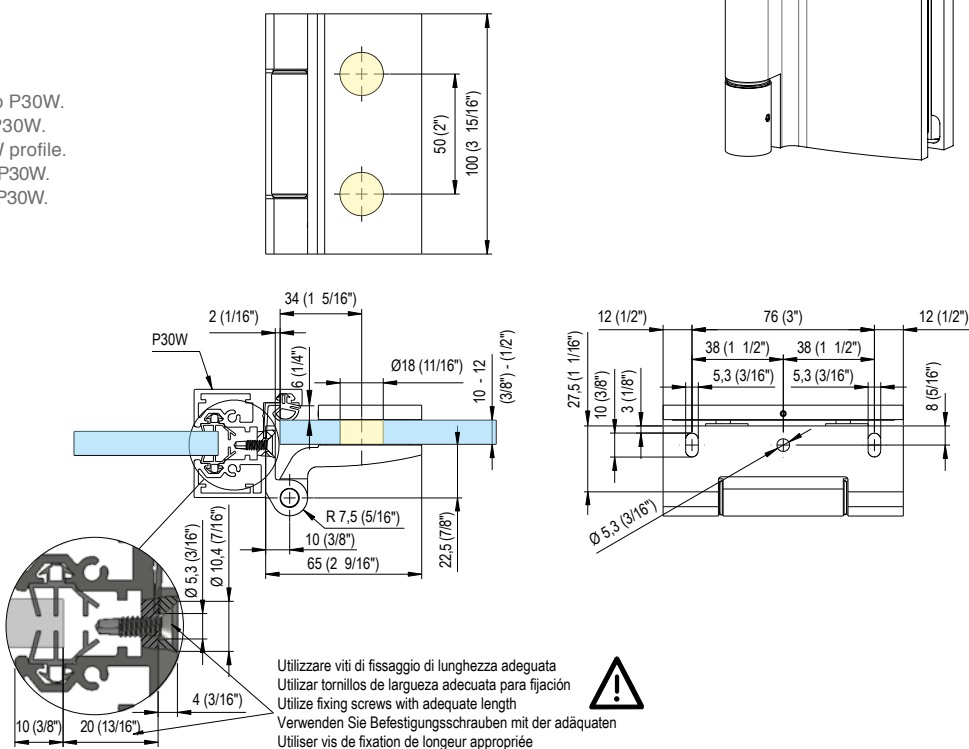

Configurazioni possibili / Possible configurations

P30W

P20E
(NOT INLCUED)

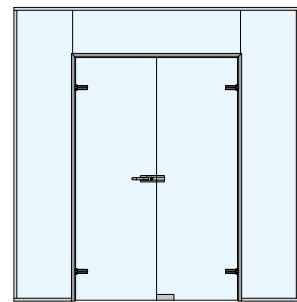
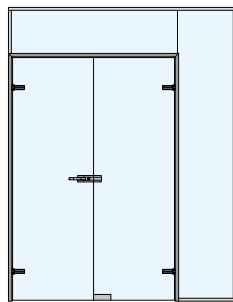
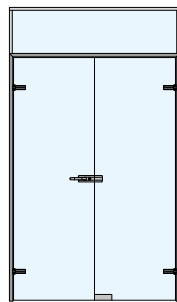
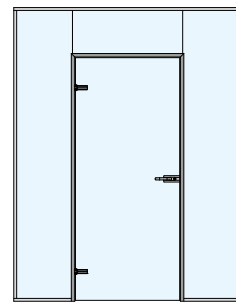
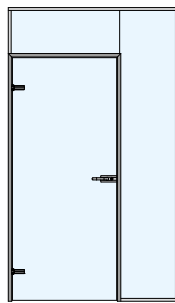
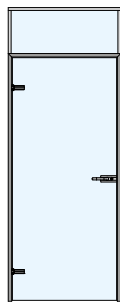
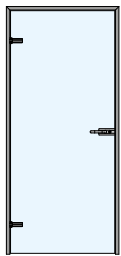
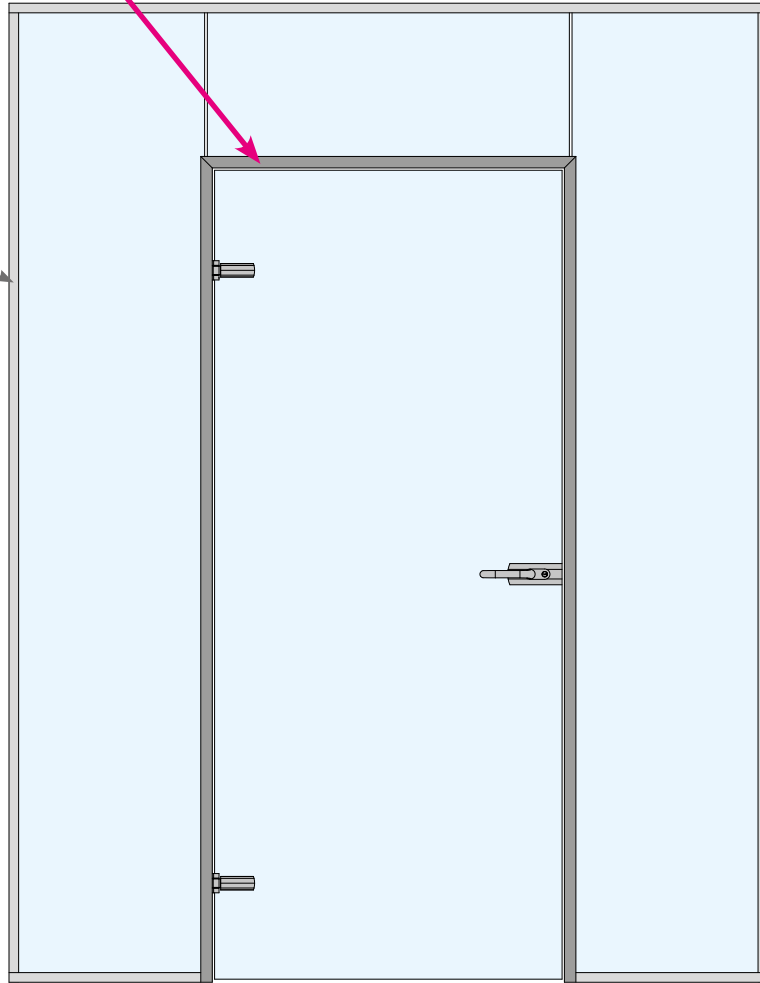

Dimensionamento vetri / Glass sizes

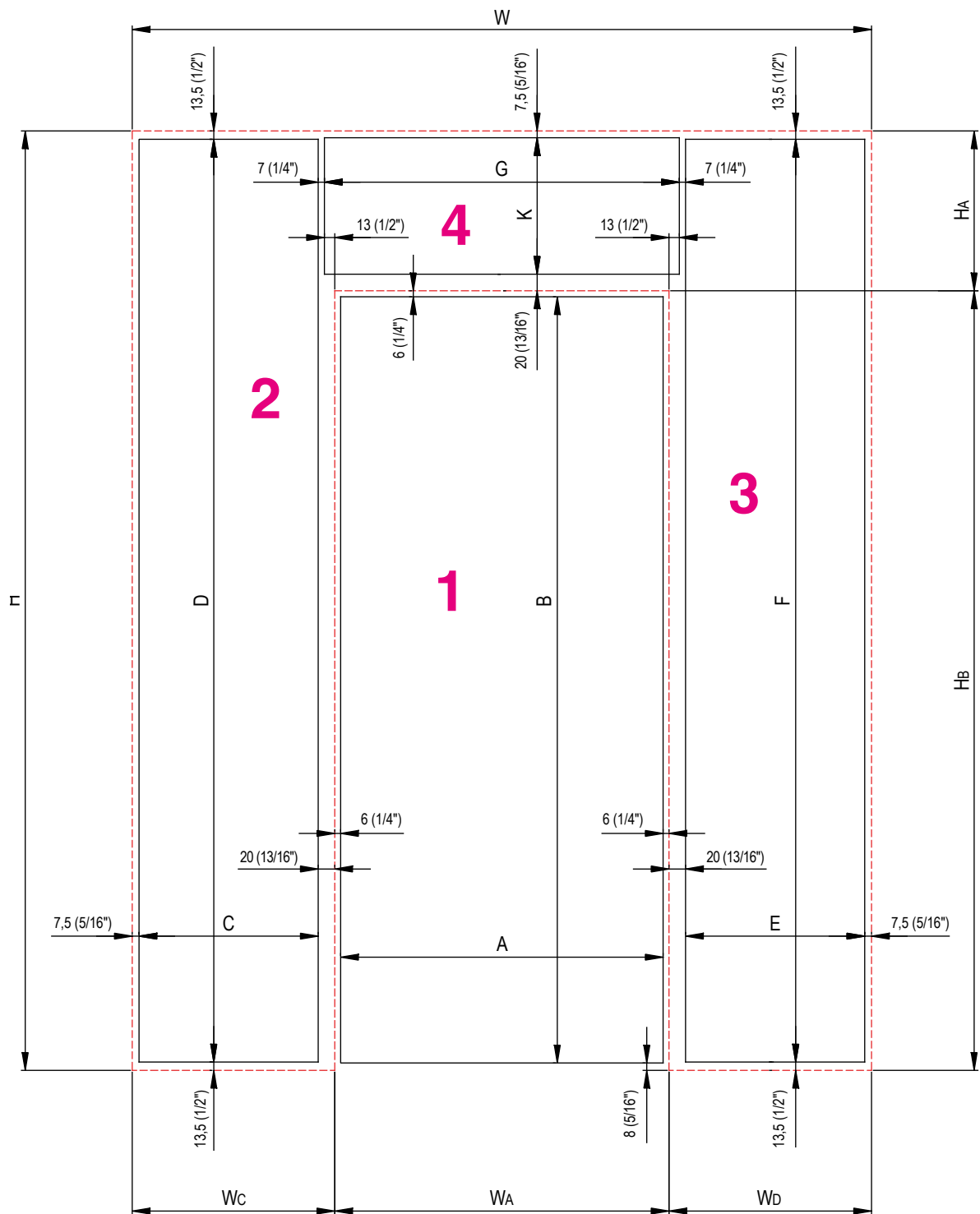

$$2. C = W_c - 27,5\text{mm}$$

$$D = H - 27\text{mm}$$

$$1. A = W_A - 12\text{mm}$$

$$B = H_B - 14\text{mm}$$

$$3. E = W_D - 27,5\text{mm}$$

$$F = H - 27\text{mm}$$

$$4. G = W_A + 26\text{mm}$$

$$K = H_A - 27,5\text{mm}$$

profili / profiles

system **ESPRO**

Alluminio / Aluminium - finiture / colors 02

Espro è un sistema modulare di profili che consente la realizzazione di vetrate continue di rapida e semplice installazione. I profili contengono dispositivi di sostegno e pinze e accolgono vetri con spessori da 8 a 12,38 mm. Grazie a snodi e a speciali guarnizioni si possono creare molteplici spazi con sorprendenti effetti di continuità.

Con il profilo Espro è anche possibile creare cornici eleganti e di design ad ingressi con porte in vetro temperato. Il profilo è in alluminio anodizzato e viene fornito in verghe lunghe 3200 mm. Appositamente studiato per inglobare al suo interno cerniere e serrature Colcom è disponibile mediante due semplici variazioni sia per porte in battuta che a 180°.

Espro es un sistema modular de perfiles que permite la creación de vidrios continuos de fácil y rápida instalación. Los perfiles contienen dispositivos de apoyo y pinzas y tienen cristales con grosor de 8 a 12,38 mm. Gracias a los sellos y las especiales articulaciones, se pueden crear diferentes espacios con sorprendentes efectos de continuidad. El perfil para puerta del sistema Espro, es la solución ideal y esencial para crear un marco elegante y de diseño y para la puerta de vidrio templado. El perfil es de aluminio anodizado y viene cortado con una longitud 3200mm. Realizado para englobar en su interior bisagras y cerraduras Colcom y disponible mediante dos simples variaciones para puertas con tope o a 180°.

Espro is a modular profile system that allows the creation of continuous glass walls quickly and easily installable. The profiles contain support devices and clamps that hold glass from 8 to 12.38 mm thick. Thanks to special seals and joints you can create different spaces with surprising continuity effects.

The Espro system profile is the ideal solution to create stylish frame-sand design to entry tempered glass doors. The profile is made of ano-

dized Alu and is supplied with rods, the length is 3200 mm. The design was especially studied in order to include Colcom's hinges and locks; it is available in two versions both for door with rebate and door at 180°.

Espro ist ein modulares Profilsystem, das die schnelle und einfache Ausführung von durchgehende Glaswänden ermöglicht. Die Profile beihalten Trägervorrichtungen und Klemme für Glasdicke zwischen 8 und 12,38 mm. Dank speziellen Dichtungen und Fugen kann man unterschiedliche Raumgeometrien.

Das Türprofil vom Espro System ist eine ideale und schlichte Lösung, um elegante Rahmen mit erlesenem Design an Eingängen mit Türen aus Sekuritglas zu kreieren. Das Profil ist aus eloxiertem Aluminium und wird in 3200 mm langen Stangen geliefert. Es wurde eigens für den Einbau von Colcom Scharnieren und Schlössern entwickelt und ist mit zwei einfachen Variationen sowohl für Anschlagtüren als auch für 180°-Türen erhältlich.

Espro est un système de profil modulaire vous permettant d'installer rapidement et facilement vos cloisons en verre. Les profils sont équipés d'un système de maintien et de pinces à verre d'une épaisseur comprise entre 8 et 12,38 mm. Grâce aux différents raccords ou joints, vous pouvez créer des espaces variés tout en conservant un aspect de continuité.

Le profil système Espro est une solution idéale pour créer des châssis de porte élégants et design pour vos portes d'entrée en verre trempé. Le profil est fabriqué en aluminium anodisé et fourni en longueur de 3200 mm. Ce système a été étudié pour intégrer au mieux les charnières et serrures de la marque Colcom dans la structure. Deux versions disponibles : porte avec butée ou porte 180°. Appliquable sur mur ou sur verre.





ESPRO



Profili per porte - Perfil para puerta
Doors profiles - Türprofile - Profil pour porte

• Il profilo per porte del sistema Espro, è la soluzione ideale ed essenziale per creare cornici eleganti e di design ad ingressi con porte in vetro temperato. Il profilo è in alluminio anodizzato e viene fornito in verghe lunghe 3200 mm. Appositamente studiato per inglobare al suo interno cerniere e serrature Colcom, è disponibile mediante due semplici variazioni sia per porte in battuta che a 180°.

• El perfil para puerta del sistema Espro, es la solución ideal y esencial para crear un marco elegante y de diseño y para la puerta de vidrio templado. El perfil es de aluminio anodizado y viene cortado con una longitud 3200mm. Realizado para englobar en su interior bisagras y cerraduras Colcom y disponible mediante dos simples variaciones para puertas con tope o a 180°.

• The Espro system is an ideal linear solution which creates an elegant modern frame with tempered glass doors. The profiles are made of anodized Alu and are supplied in 3200mm lengths. They have been designed to accept Colcom hinges and locks; they are available in two versions both for a rebated and non - rebated door.

• Das Türprofil vom Espro System ist eine ideale und schlichte Lösung, um elegante Rahmen mit erlesenem Design an Eingängen mit Türen aus Sekuritglas zu kreieren. Das Profil ist aus eloxiertem Aluminium und wird in 3200 mm langen Stangen geliefert. Es wurde eigens für den Einbau von Colcom Scharnieren und Schlössern entwickelt und ist mit zwei einfachen Variationen sowohl für Anschlagtüren als auch für 180°-Türen erhaltlich.

• Le profil pour porte du système Espro est la solution idéale et essentielle pour créer des cadres élégants et des entrées avec portes en verre trempé. Le profil en aluminium est anodisé et est livré avec des tiges de longueur 3200 mm. Spécialement étudié pour incorporer à l'intérieur les charnières et serrures Colcom, il est disponible au moyen de deux modifications simples pour les portes en arrêt à 180°.

PCC08K/3

PROFILO DI BASE - PERFIL BÁSICO
BASILAR PROFIL - GRUNDPROFIL
PROFIL DE BASE

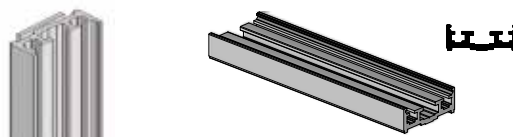

PORTE - PUERTAS - DOORS - TÜREN - PORTES 90°

PCC08K/3
+ PCC03K/3



- Montante per porte in battuta
- Montante para puertas a 90°
- Frame for doors at 90°
- Rahmen für 90°-Türen
- Montant pour porte en fermeture à 90°

Cerniere disponibili - Available hinges

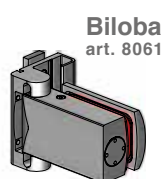

Biloba
art. 8066

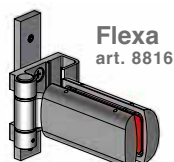

Flexa
art. 8816



UTILIZZABILE SINGOLARMENTE
UTILIZAR TAMBIEN UNO A UNO
ALSO USABLE SINGULARLY
EINZELN VERWENDBAR
UTILISABLE INDIVIDUELLEMENT

PORTE - PUERTAS - DOORS - TÜREN - PORTES 180°

PCC08K/3
+ PCC05/3

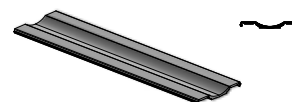

- Montante per porte ad apertura a 180°
- Montante para puertas a 180°
- Frame for doors at 180°
- Rahmen für 180° Türen
- Montant pour porte en ouverture à 180°

Cerniere disponibili - Available hinges

Biloba
art. 8066

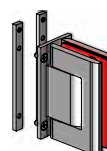

Biloba Unica
art. 101E10



art. 1027S

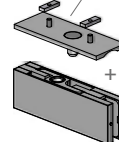

art. 100E20

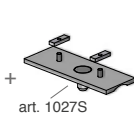

Maxima

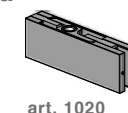
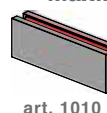

art. 1010

art. 1020

art. 1027S

Triloba

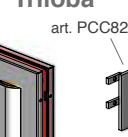
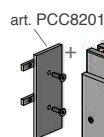

art. PCC8201

art. PCC8202

art. 8201

art. 8202

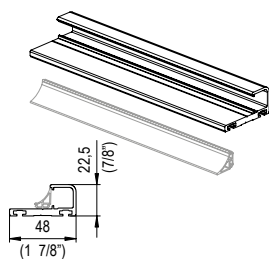

PCC03K/3

- Profilo battuta L = 3200 mm. (da abbinare con PCC02/3 o PCC08/3)
Comprensivo di guarnizione PCC15 L = 3200 mm.
- Perfil para jamba L = 3200mm (combinar con PCC02/3 o PCC08/3).
Comprensivo de herraje PCC15 L = 3200 mm.
- Profile for doors with rebate. L= 3200 (to match with PCC02/3 or PCC08/3).
Including gasket PCC15 L=3200mm.
- Profil für Türen mit Stop. Länge = 3200mm (mit PCC02/3 oder PCC08/3
kombinierbar). Mit Dichtug PCC15 L=3200mm.
- Profil en butée L = 3200 mm. (à associer avec PCC02/3 ou PCC08/3)
Joint PCC15 compris L = 3200 mm.

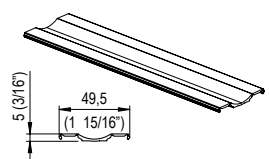

PCC05/3

- Carter di copertura per profilo stipite L=3200mm.
(da abbinare a PCC02 o PCC08)
- Charter para perfil jamba L = 3200mm
(combinar con PCC02 o PCC08).
- Covering case for door jamb profile. L=3200mm
(to match with PCC02 or PCC08).
- Abdeckung für das Falzrahmenprofil L= 3200mm
(mit PCC02 oder PCC08 kombinierbar).
- Enveloppe de protection L=3200mm.
(à associer avec PCC02 ou PCC08)

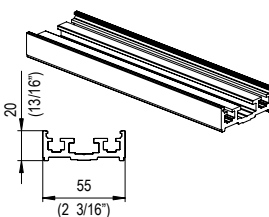

PCC08K/3

- Profilo stipite (fissaggio a muro) L= 3200 mm (da abbinare a PCC03 o PCC05) com-
prensivo di spugna Silver L = 3200mm sp. 3 mm per compensazioni a muro.
- Perfil para jamba (ajuste a pared) L = 3200mm (combinar con PCC03 o PCC05)
comprensivo de esponja Silver L = 3200mm sp. 3 mm por compensación a pared.
- Profile for door jamb (wall fixing). L=3200mm (to match with PCC03 or PCC05). In-
cluding silver sponge gasket. L=3200mm and thickness 3mm for wall compensation.
- Profil für Falzrahmen (Wandfixierung). L= 3200mm (mit PCC03 oder PCC05 kom-
binierbar). Inklusive Dichtung Silver L=3200mm und Dicke 3mm zum Ausgleich von
Toleranzen an der Wand.
- Profil pour jambage (fixation au mur) L= 3200 mm (à associer avec PCC03 ou
PCC05) joint compris. L = 3200mm ép. 3 mm pour compensation au mur.

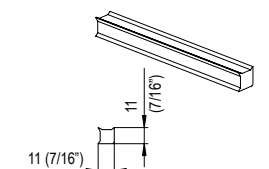

PCC12/3

- Profilo fermavetro 2 vie 90° in policarbonato con bi-adesivo sp. 0,5 mm - L=3200 mm.
Per vetri da 10 a 10,38 mm.
- Perfil refuerzo – dos vías 90° en policarbonato con doble pegamento esp. 0.5mm –
L = 3200mm. Para vidrio desde 10 hasta 10,38 mm.
- Two ways polycarbonate profile 90° for panel fixing with 0,5mm bi-adhesive. L=3200mm.
For glass from 10 to 10,38mm.
- Zweiweganschlussstück aus Polycarbonat, 90° mit 0,5mm Doppelklebung.
Länge=3200mm. Für Glas vom 10 bis 10,38mm.
- Joint intercalaire 90° à 2 axes en polycarbonate avec adhésif double-face ép. 0,5 mm
- L=3200 mm. Pour verre de 10 à 10,38 mm.

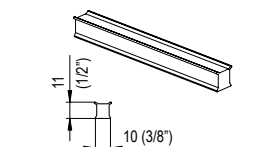

PCC13/3

- Profilo fermavetro 3 vie in policarbonato con bi-adesivo sp. 0,5 mm - L=3200 mm.
Per vetri da 10 a 10,38 mm.
- Perfil refuerzo – tre vías en policarbonato con doble pegamento esp. 0.5mm – L = 3200mm.
Para vidrio desde 10 hasta 10,38 mm.
- Three ways polycarbonate profile for panel fixing with 0,5mm bi-adhesive. L=3200mm.
For glass from 10 to 10,38mm.
- Dreiweganschlussstück aus Polycarbonat mit 0,5mm Doppelklebung. Länge=3200mm.
Für Glas vom 10 bis 10,38mm.
- Joint intercalaire à 3 axes en polycarbonate avec adhésif double-face ép. 0,5 mm - L=3200
mm. Pour verre de 10 à 10,38 mm.

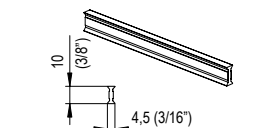

PCC14/3

- Profilo fermavetro 2 vie in policarbonato con bi-adesivo sp. 0,5 mm L=3200 mm.
Per vetri da 10 a 10,38 mm.
- Perfil refuerzo – dos vías en policarbonato con doble pegamento esp. 0.5mm –
L = 3200mm. Para vidrio desde 10 hasta 10,38 mm.
- Two ways polycarbonate profile for panel fixing with 0,5mm bi-adhesive.
L=3200mm. For glass from 10 to 10,38mm.
- Zweiweganschlussstück aus Polycarbonat mit 0,5mm Doppelklebung.
Länge=3200mm. Für Glas vom 10 bis 10,38mm.
- Joint intercalaire à 2 axes en polycarbonate avec adhésif double-face ép. 0,5 mm -
L=3200 mm. Pour verre de 10 à 10,38 mm.

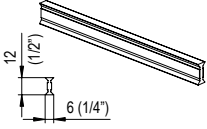
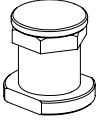
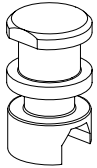
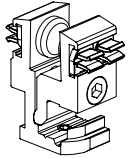
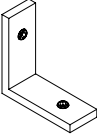
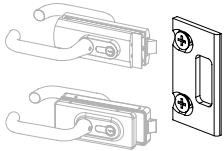
	<p>PCC18/3</p>	<ul style="list-style-type: none"> • Profilo fermavetro 2 vie in policarbonato con bi-adesivo sp. 0,5 mm - L=3200 mm. Per vetri da 12 mm. • Perfil refuerzo – dos vías en policarbonato con doble pegamento esp. 0.5mm – L = 3200mm. Para vidrio de 12mm. • Two ways polycarbonate profile for panel fixing with 0,5mm bi-adhesive. L=3200mm. For 12mm glass. • Zweiweganschlussstück aus Polycarbonat mit 0,5mm Doppelklebung. Länge=3200mm. Für 12mm Glas. • Profil de renfort à 2 axes en policarbonate avec adhésif double-face ép. 0,5 mm - L=3200 mm. Pour verre de 12 mm.
	<p>PCC20</p>	<ul style="list-style-type: none"> • Gruppo sostegno vetro con regolazione di messa a bolla. • Grupo de sostén para vidrio con ajuste para poner a nivel. • Glass support unit with bubble levelling adjustment. • Glasträger mit Nivellierungsmöglichkeit. • Élément de soutien pour verre avec réglage du niveau.
	<p>PCC21</p>	<ul style="list-style-type: none"> • Sostegno vetro superiore a scatto. • Sostén para vidrio superior con retención. • Clicking support for top glass. • Klipp für oberes Glas. • Support supérieur pour verre.
	<p>PCC22</p>	<ul style="list-style-type: none"> • Gruppo pinza per vetri sp. da 8 a 12,38 mm. • Grupo pinza para vidrio esp. desde 8mm hasta 12.38 mm. • Clamp unit for glass thickness from 8 to 12.38 mm. • Klemmeinheit für Glasdicke vom 8 bis 12,38 mm. • Unité de serrage pour verre ép. de 8 à 12,38 mm.
	<p>PCC37</p>	<ul style="list-style-type: none"> • Connettore a 90° per PCC08K/302. • Conexión de 90° para PCC08K/302. • 90° corner connection for PCC08K/302. • 90° Anschlussplatte für PCC08K/302. • Connecteur à 90° pour PCC08K/302.
	<p>0641S</p>	<ul style="list-style-type: none"> • Piastrina (fissaggio su PCC03) per serrature Flexa e Flexa-L. • Placa (ajuste de PCC03) para cerraduras "Flexa" y "Flexa-L". • Plate (fixing on PCC03) for FLEXA and FLEXA-L locks. • Platte (Fixierung an PCC03) für Schlösser FLEXA und FLEXA-L. • Plaque (fixation sur PCC03) pour serrure Flexa et Flexa-L.

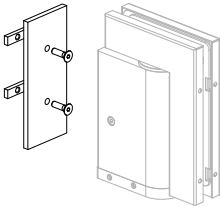
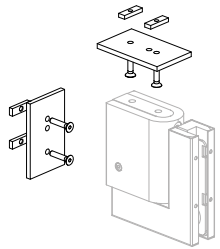
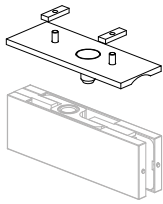
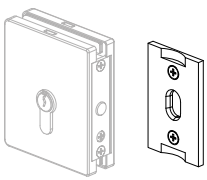
	<p>PCC8201</p>	<ul style="list-style-type: none"> • Piastrina per attacco cerniera TRILOBA (art.8201) nei profili PCC02 e PCC08. • Placa de ajuste bisagra serie "Triloba" (8201) a los perfiles PCC02 y PCC08. • Plate for the installation of TRILOBA hinge (item 8201) on profiles PCC02 and PCC08. • Fixierungsplatte für das Scharnier TRILOBA (Art. 8201) an die Profile PCC02 und PCC08. • Plaque de fixation pour charnière TRILOBA (art.8201) sur profils PCC02 et PCC08.
	<p>PCC8202</p>	<ul style="list-style-type: none"> • Piastrina per attacco cerniera TRILOBA (art.8202) nei profili PCC02 e PCC08. • Placa de ajuste bisagra serie "Triloba" (8202) a los perfiles PCC02 y PCC08. • Plate for the installation of TRILOBA hinge (item 8202) on profiles PCC02 and PCC08. • Fixierungsplatte für das Scharnier TRILOBA (Art. 8202) an die Profile PCC02 und PCC08. • Plaque de fixation pour charnière TRILOBA (art.8202) sur profils PCC02 et PCC08.
	<p>1027S</p>	<ul style="list-style-type: none"> • Piastrina per attacco cerniera Serie MAXIMA (art.1020) nei profili PCC02 e PCC08. • Placa de ajuste bisagra serie "Maxima" (art. 1020) a los perfiles PCC02 y PCC08. • Plate for the installation of Series MAXIMA hinge (item 1020) on profiles PCC02 and PCC08. • Fixierungsplatte für das Scharnier der Serie MAXIMA (Art. 1020) an die Profile PCC02 und PCC08. • Plaque de fixation pour charnière série MAXIMA (art.1020) sur profils PCC02 et PCC08.
	<p>0030S</p>	<ul style="list-style-type: none"> • Piastrina per attacco serratura art.6630. • Placa de ajuste cerradura art. 6630. • Plate for the installation of lock 6630. • Fixierungsplatte für das Schloss 6630. • Plaque de fixation de serrure art.6630.

8066

BILOBA®

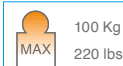
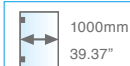
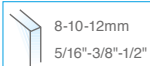

• Cerniera oleodinamica con regolazione delle velocità di chiusura dell'anta. Stop a 0° +90° -90°. **Adatta anche per porte in battuta. Comprensiva di fissaggio e predisposta per alloggiamento nei profili PCC02 e PCC08.**

• Bisagra cierra puerta hidráulica con ajuste de velocidad de cierre de la puerta. Freno a 0°, + 90°, -90°. **Adecuada por puertas con tope. Comprensiva de placa de fijación y predispuesta para engargolar en los perfiles PCC02 y PCC08.**

• Hydraulic hinge with adjustment of the closing speed of the door. Stop at 0° +90° -90°. Suitable for doors with stop. With connecting plate for installation on profiles PCC02 and PCC08.

• Hydraulikscharnier mit Einstellung der Türschließgeschwindigkeit. Feststellung bei 0° +90° -90°. **Geeignet für Anschlagtüren. Mit Verbindungsplatte zu den Profilen PCC02 und PCC08.**

• Charnière hydraulique avec réglage de la vitesse de fermeture. Arrêt à 0°, +90° et -90°. Adapté pour les portes en butées. Avec plaque de raccordement pour une installation sur les profils PCC02 et PCC08.

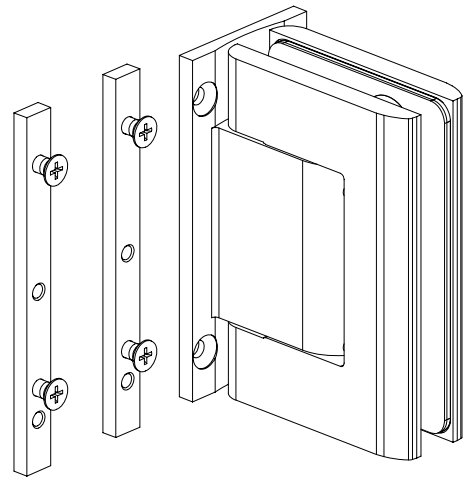

Classificazione secondo normativa - Clasificación según la ley - Classification according to the law Klassifizierung nach den Vorschriften



art. 8066 UNI EN 1154 : 2006 3 8 2 0 1 4

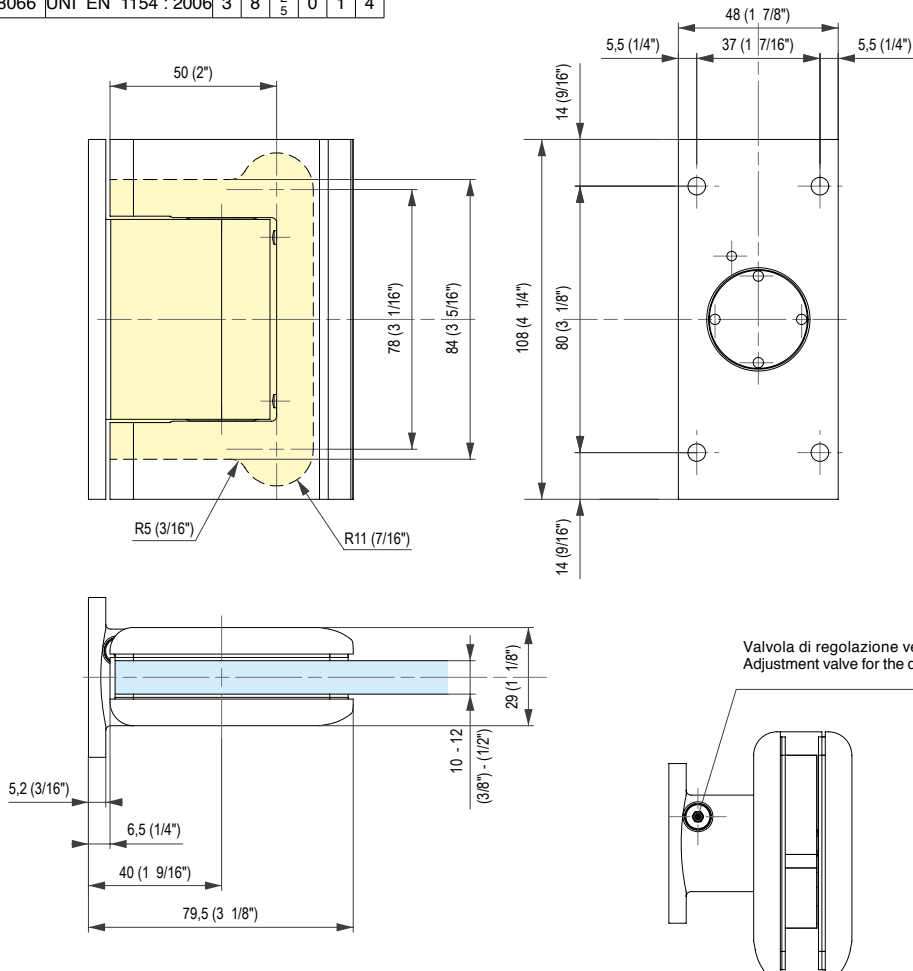

Esempio di applicazione - Example of installation

Piastrine di fissaggio fornite nell'imballo
Placas de fijación suministradas en el embalaje
Mounting plates supplied in packaging
Montageplatte in der Verpackung

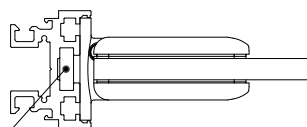

TESTATA 1.000.000 CICLI.
TESTED FOR 1.000.000 CYCLES.

8061

BILOBA®

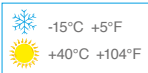
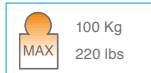
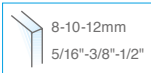
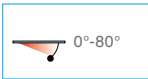

• Cerniera oleodinamica con regolazione delle velocità di chiusura dell'anta per porte in battuta. **Per sistema vetrate continue Espro.** Stop a 0° +90°.

• Bisagra cierra puerta hidráulica con ajuste de velocidad de cierre de la puerta con tope. **Para sistema de pared continua "Espro".** Freno a 0°, +90°.

• Hydraulic hinge with adjustment of the door closing speed. For doors with stop. **For system of continuous glass windows Espro.** Stop at 0° +90°.

• Hydraulischscharnier mit Einstellung der Türschließgeschwindigkeit bei Anschlagtüren. **Für Glaswandssysteme Espro.** Feststellung bei 0°+90°.

• Charnière hydraulique avec régulation de la vitesse de fermeture pour porte en butée. Pour système de fenêtre Espro. Arrêt à 0° et +90°.

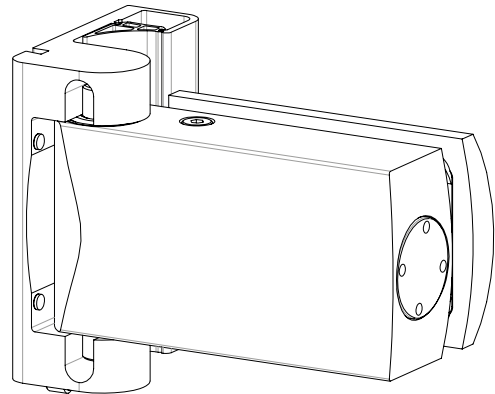

Classificazione secondo normativa - Clasificación según la ley - Classification according to the law Klassifizierung nach den Vorschriften



art. 8061	UNI EN 1154 : 2006	3	8	2	5	0	1	4
-----------	--------------------	---	---	---	---	---	---	---

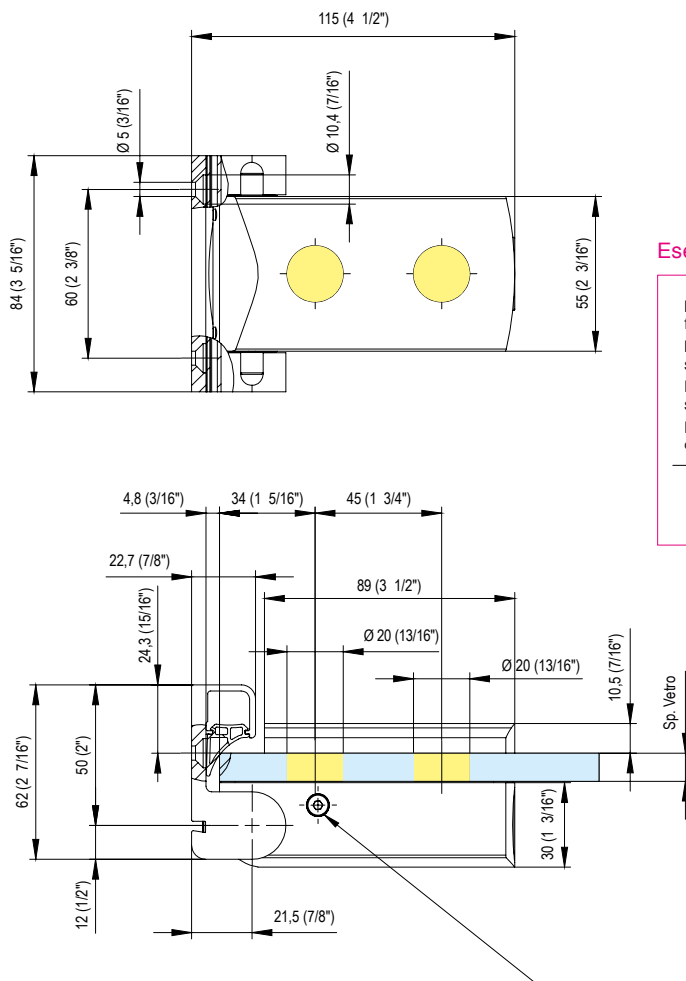

Esempio di applicazione - Example of installation

Plastrina di fissaggio fornita nell'imballo
Placa de fijación suministrada en el embalaje
Mounting plate supplied in packaging
Montageplatte in der Verpackung

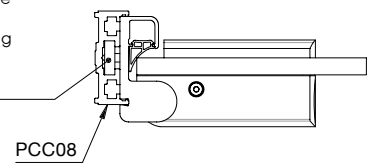

TESTATA 1.000.000 CICLI.
TESTED FOR 1.000.000 CYCLES.

8816

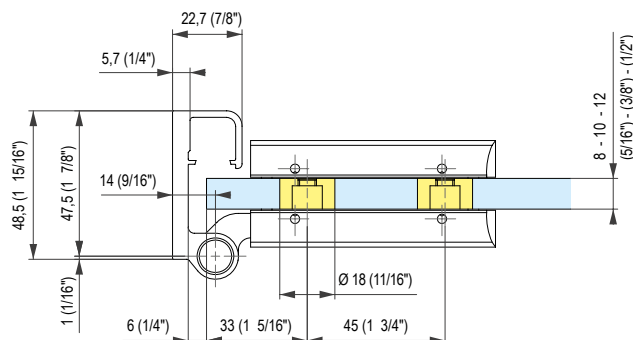
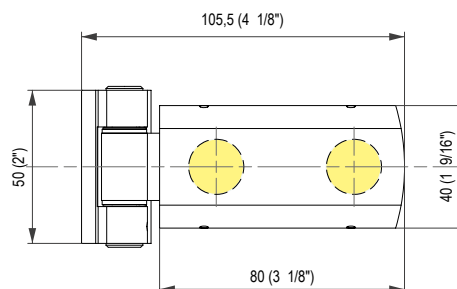
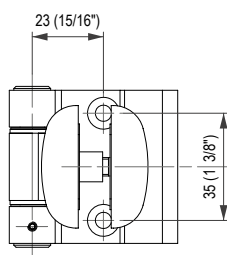
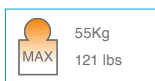

• Cerniera FLEXA comprensiva di fissaggio e predisposta per alloggiamento nei profili PCC02 e PCC08.

• Bisagra FLEXA comprensiva de placa de fijación y predispuesta para engargolar en los perfiles PCC02 y PCC08.

• FLEXA hinge with connecting plate for installation on profiles PCC02 and PCC08.

• FLEXA Scharnier mit Montageplatte, geeignet zur Anbringung an die Profile PCC02 und PCC08.

• Charnière FLEXA avec plaque de fixation pour une installation sur les profils PCC02 et PCC08.

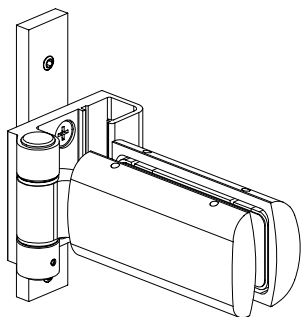

Esempio di applicazione Example of installation

Piastrina di fissaggio fornita nell'imballo
Placa de fijación suministrada en el embalaje
Mounting plate supplied in packaging
Montageplatte in der Verpackung

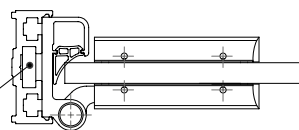

ESPRO

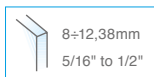

Esempio di installazioni porte scorrevoli - Ejemplo de instalación de puertas correderas - Mounting examples with sliding doors - Beispiele für die Montage von Schiebeseystemen - Exemple d'installation pour porte coulissante

Versione / Version

***FLO System**

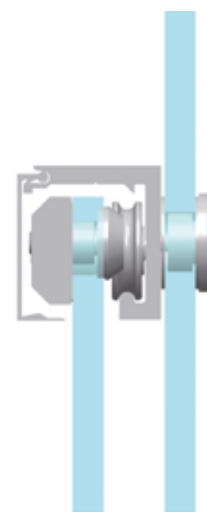
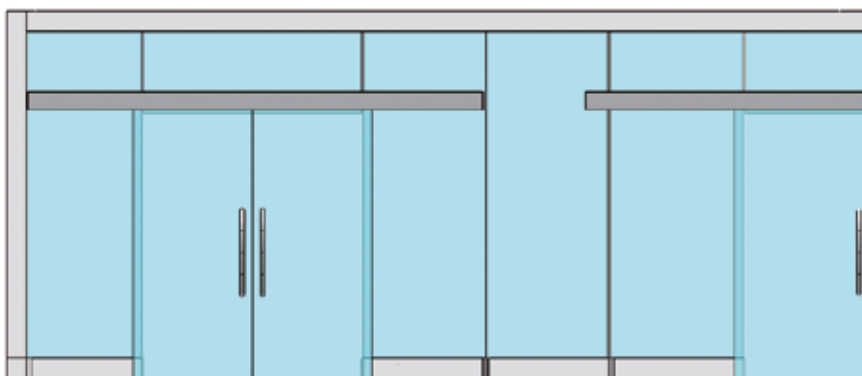

* Schede tecniche specifiche nella sezione Porte Scorrevoli- Fichas técnicas particulares en la sección "Puertas correderas"
Specific technical data sheets in section Sliding Doors - Bestimmte, technische Blätter in der Sektion Schiebetüre - Fiches techniques dans la section portes coulissantes

profili guarnizione / glass dry joints

serie **JOINT**

I profili guarnizione JOINT sono la soluzione ideale per unire pareti divisorie interne in vetro. Garantiscono una finitura elegante e minimale delle pareti in vetro. Sono un'alternativa al silicone, la loro installazione è rapida e facile perché utilizza un nastro adesivo integrale ad alta adesione, eliminando lo sporco e lo spreco che il silicone può generare. Sono disponibili nelle versioni nera e trasparente e in una ampia gamma di altri colori (come RAL, BS e Pantone).

Los perfiles guarnición JOINT ofrecen la solución ideal para unir paredes internas de vidrio, dotando las particiones de vidrio de un acabado elegante y minimalista. Siendo una alternativa a la silicona, JOINT minimiza el tiempo de instalación, haciéndola rápida y fácil porque se utiliza una cinta adhesiva integral de alta adhesión, eliminando la mugre y el derroche que el uso de la silicona puede generar. Están disponibles en claro y negro, así como en una amplia gama de otros colores (según los estándares RAL, BS y Pantone).

Glass dry joints offer the ideal solution for joining slimline internal glass partitions, providing a sleek and minimal finish to enhance the overall aesthetics of your glass partition. Providing a suitable alternative to silicone JOINT minimise on-site time with quick, easy installation using

integral high bond adhesive tape, whilst removing the mess and waste that sealants can create. They are available in clear and black, as well as a wide range of other colours (according to RAL, BS and Pantone standards).

Die JOINT-Dichtungsprofile bieten die ideale Lösung für die Verbindung von inneren Glastrennwänden und bieten eine elegante und minimalistische Oberfläche der Glaswände. Als Alternative zu Silikon minimiert JOINT die Installationszeit und macht es schnell und einfach, da es ein integriertes Klebeband mit hoher Haftung verwendet, wodurch der Schmutz und die Abfälle, die das Silikon erzeugen kann, eliminiert werden. Sie sind in den Farben Klar und Schwarz sowie in vielen anderen Farben erhältlich (gemäß RAL-, BS- und Pantone-Standards).

Les profilés d'étanchéité JOINT offrent la solution idéale pour assembler des cloisons vitrées internes, offrant une finition élégante et minimaliste sur les parois vitrées. Étant une alternative au silicone, JOINT minimise le temps d'installation et le rend rapide et facile car il utilise un ruban adhésif intégral à haute adhérence, éliminant la saleté et les déchets que le silicone peut générer. Ils sont disponibles en clair et en noir, ainsi que dans une vaste gamme d'autres couleurs (conformes aux normes RAL, BS et Pantone).



"I" Joint

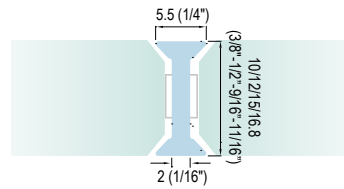
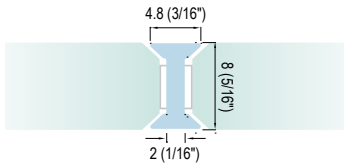

Articolo Code	Vetro - Glass		L
	standard	laminated	
1118001 ●	8mm (5/16")	8.8mm	3m
1071001 ●	10mm (3/8")	10.8mm	3m
1071081 ●	10mm (3/8")	10.8mm	3m
1071201 ●	12mm (1/2")	12.8mm	3m
1071281 ●	12mm (1/2")	12.8mm	3m
1091501 ●	15mm (9/16)	15.8mm	4m
1099801 ●	-	16.8mm	4m

"H" Section

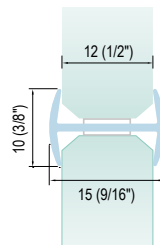
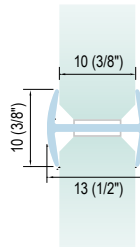

Articolo Code	Vetro - Glass		L
	standard	laminated	
1080001 ●	10mm (3/8")	10.8mm	3m
1080081 ●	10mm (3/8")	10.8mm	3m
1080101 ●	12mm (1/2")	12.8mm	3m
1080181 ●	12mm (1/2")	12.8mm	3m

Abutment Joint

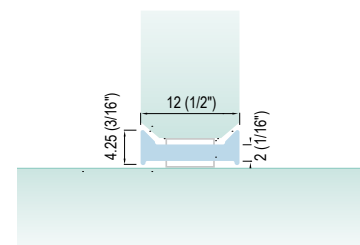
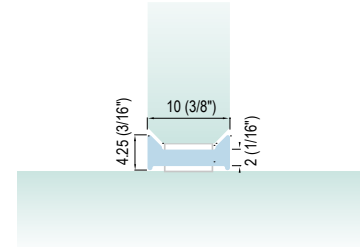
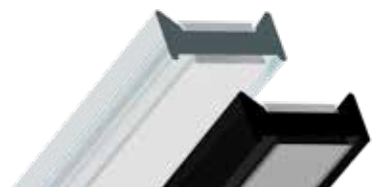

Articolo Code	Vetro - Glass		L
	standard	laminated	
1081101 ●	10mm (3/8")	10.8mm	3m
1081181 ●	10mm (3/8")	10.8mm	3m
1081201 ●	12mm (1/2")	12.8mm	3m
1081281 ●	12mm (1/2")	12.8mm	3m

Square Corner Joint

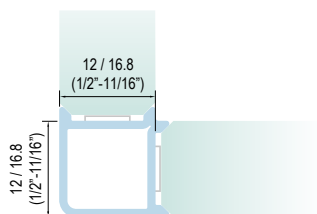
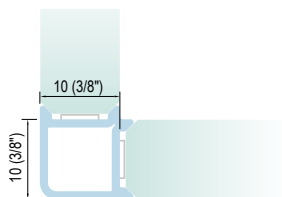

Articolo Code	Vetro - Glass		L
	standard	laminated	
1121001 ●	10mm (3/8")	10.8mm	3m
1121081 ●	10mm (3/8")	10.8mm	3m
1121201 ●	12mm (1/2")	12.8mm	3m
1121281 ●	12mm (1/2")	12.8mm	3m
1124001 ●	-	16.8mm	4m
1124081 ●	-	16.8mm	4m

Flexible "I" Joint

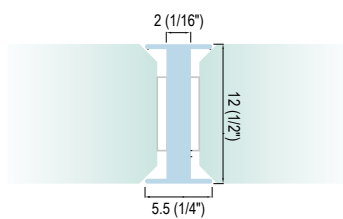
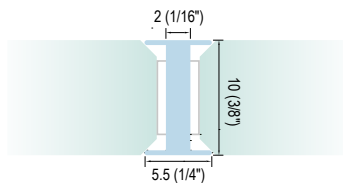

Articolo Code	Vetro - Glass		L
	standard	laminated	
1096001 ●	10mm (3/8")	10.8mm	3m
1096201 ●	12mm (1/2")	12.8mm	3m

Minimal Corner Joint

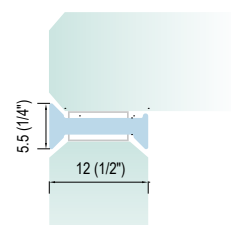
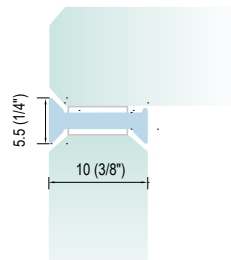
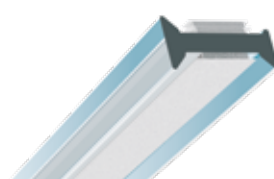

Articolo Code	Vetro - Glass		L
	standard	laminated	
1091001 ●	10mm (3/8")	10.8mm	3m
1091201 ●	12mm (1/2")	12.8mm	3m

135° Connection

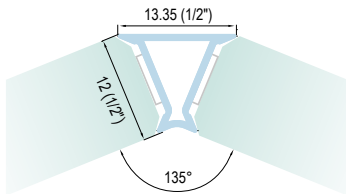
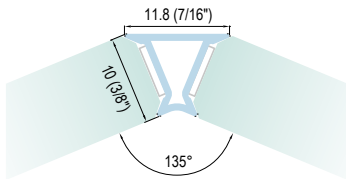

Articolo Code	Vetro - Glass		L
	standard	laminated	
1071501 ●	10mm (3/8")	10.8mm	3m
1071701 ●	12mm (1/2")	12.8mm	3m

3-Way Joint

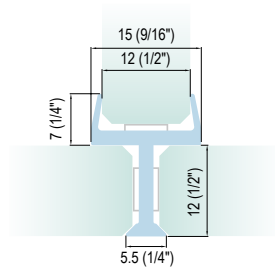
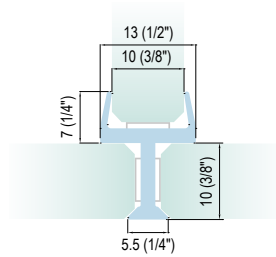

Articolo Code	Vetro - Glass		L
	standard	laminated	
1071401 ●	10mm (3/8")	10.8mm	3m
1071601 ●	12mm (1/2")	12.8mm	3m

90° Corner Protection

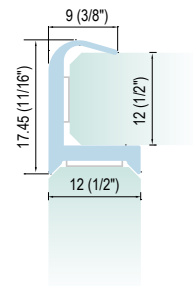
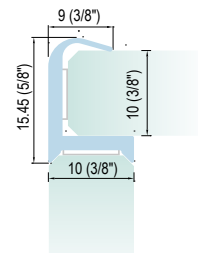

Articolo Code	Vetro - Glass		L
	standard	laminated	
1071101 ●	10mm (3/8")	10.8mm	3m
1071301 ●	12mm (1/2")	12.8mm	3m

guarnizioni porte vetro / glass door seals

serie **JOINT**

Le guarnizioni per porte in vetro JOINT rappresentano la soluzione ideale per sigillare perimetri e soglie delle porte in vetro. Il sistema porte è stato progettato ad integrazione della gamma di profili guarnizione. La finitura elegante e minimale è assicurata così come la continuità estetica delle pareti in vetro. La gamma comprende anche un profilo isolante automatico. Disponibile in alluminio naturale e nero, questo profilo è il tocco finale alle porte in vetro con e senza frame.

Las guarniciones para puertas en vidrio JOINT representan la solución ideal para sellar perímetros y umbral de puertas en vidrio. El sistema de puertas se ha desarrollado para funcionar en combinación con la gama de guarniciones, para proveer un acabado elegante y minimalista, que complete la continuidad estética de las particiones en vidrio. La gama también incluye un perfil de aislamiento automático. Está disponible en aluminio anodizado natural y negro, y le da el toque final a las puertas de vidrio, tanto enmarcadas como sin marco.

JOINT glass door seals provide an ideal solution for perimeter and threshold sealing of glass doors. The door system has been designed to work in conjunction with the dry joint range to provide a sleek and minimal finish to enhance the overall aesthetics of fully glazed partitions.

The range also includes an automatic isolating profile. It is available in natural anodized and black aluminium, and gives the final touch to glass doors, both framed and frameless.

Die Dichtungen für JOINT-Glastüren sind die ideale Lösung zum Abdichten von Umfängen und Schwellen von Glastüren. Das Türsystem wurde so konzipiert, dass es in Kombination mit der Reihe der Dichtungsprofile eine elegante und minimalistische Oberfläche bietet, um die ästhetische Kontinuität der Glaswände zu vervollständigen. Zum Sortiment gehört auch ein automatisches Trennprofil. Es ist in natur eloxiertem und schwarzem Aluminium erhältlich und verleiht Glastüren, sowohl gerahmt als auch rahmenlos, den letzten Schliff.

Les joints des portes en verre JOINT sont la solution idéale pour sceller les périmètres et les seuils des portes en verre. Le système de porte a été conçu pour fonctionner en combinaison avec la gamme de profils de joint afin de fournir une finition élégante et minimale pour compléter la continuité esthétique des parois en verre. La gamme comprend également un profil d'isolation automatique. Il est disponible en aluminium anodisé naturel et noir, et donne la touche finale aux portes en verre, encadrées ou non.



Side Seal

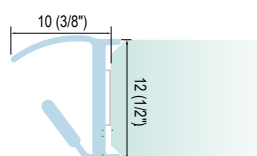
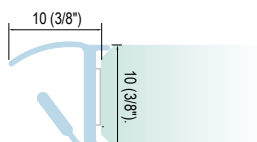

Articolo Code	Vetro - Glass		L
	standard	laminated	
1084901	10mm (3/8")	10.8mm	3m
1097001	12mm (1/2")	12.8mm	3m



Top & Bottom Seal

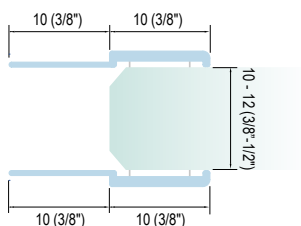

Articolo Code	Vetro - Glass		L
	standard	laminated	
1093601	10mm (3/8")	10.8mm	3m
1093601	12mm (1/2")	12.8mm	3m



GUIDA ALL'INSTALLAZIONE GUARNIZIONI PORTA VETRO

GLASS DOOR SEALS INSTALLATION GUIDE

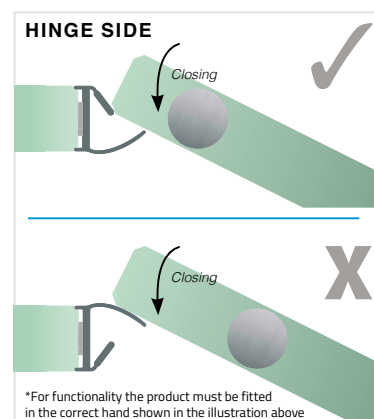
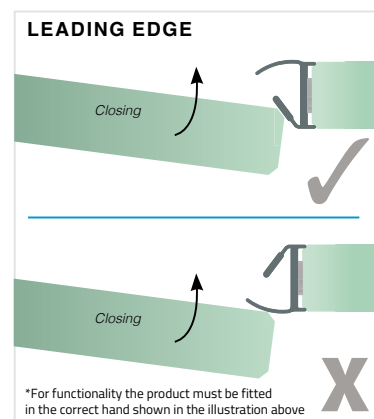

1460GD083● ● ●
830mm**1460GD103**● ● ●
1030mm**1460GD123**● ● ●
1230mm

• Profilo isolante in lega di alluminio 6060, per porta in vetro. Anodizzato o verniciato. Con guarnizione tubolare in EPDM.

• Perfil aislante en aleación de aluminio 6060 para puertas de vidrio. Anodizado o recubierto. Junta tubular fabricada en EPDM.

• Isolating profile in aluminium alloy 6060 for glass doors. Anodized or coated. Tubular gasket made of EPDM.

• Isolierprofil aus Aluminiumlegierung 6060 für Glastüren. Eloxiert oder beschichtet. Rohrdichtung aus EPDM.

• Profilé d'isolation en alliage d'aluminium 6060 pour portes en verre. Anodisé ou enduit. Joint tubulaire en EPDM.

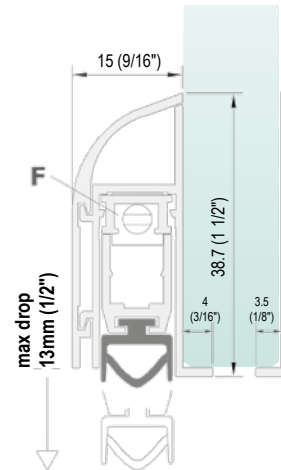
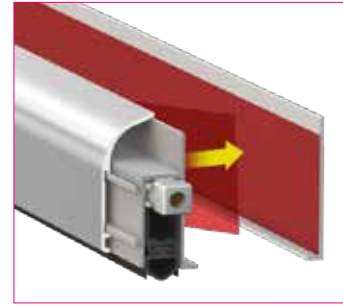
**1122501**●
3m**1124101**●
3m

• Pellicole nere auto adesive che possono essere applicate su partizioni in vetro, in verticale e orizzontale. Adatte per applicazioni successive all'installazione, facili da rimuovere.

• Bandas negras autoadhesivas, que se pueden aplicar en particiones de vidrio, tanto vertical como horizontalmente. También se pueden aplicar como un segundo paso, y su eliminación es fácil.

• Self-adhesive black bands, which can be applied on glass partitions, both vertically and horizontally. They can also be applied as a second step, and their removal is easy.

• Selbstklebende schwarze Bänder, die sowohl vertikal als auch horizontal auf Glastrennwände aufgebracht werden können. Sie können auch als zweiter Schritt angewendet werden und lassen sich leicht entfernen.

• Bandes noires autocollantes pouvant être appliquées sur des cloisons en verre, tant verticalement qu'horizontalement. Ils peuvent également être appliqués dans un deuxième temps et leur retrait est facile.

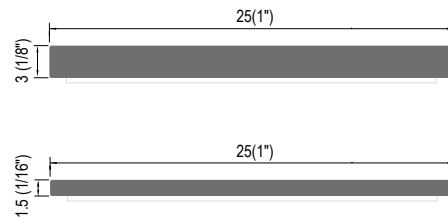
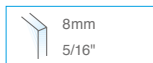
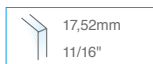
**ROLL1205****12m**8mm
5/16"**ROLL1207****12m**10mm
3/8"**ROLL1209****12m**12-12,76mm
1/2"**ROLL1214****12m**17,52mm
11/16"

- Nastro adesivo.
- Banda adhesiva.
- Adhesive Bonding Tapes
- Klebeband.
- Ruban adhésif.

**APPL-8-17.5**

Applicatore
Aplicador
Template
Schablone
Applicateurs



969291● **100m****663101**● **100m****553692**● **200m****553691**● **200m**

• Guarnizioni fermavetro a cuneo che fermano il vetro consentendo un'installazione semplice e pulita nei profili in alluminio sia di testa che di base. La linguetta a strappo consente la compatibilità con una vasta gamma di sistemi di cornici in alluminio. Le guarnizioni "Head & Base" senza telaio sono compatibili con tutti i profili guarnizione serie JOINT.

• Juntas de cuña: sostienen el vidrio, lo que permite una instalación limpia y sencilla en los perfiles de cabeza y base de aluminio. La aleta desprendible permite la compatibilidad con una gama de sistemas de marcos de aluminio de empresas. Las cuñas sin marco son compatibles con todas las series JOINT. Las juntas "Head & Base" son compatibles con todas las juntas de la serie JOINT.

• Wedge gaskets: they hold the glass, allowing a clean and simple installation on aluminium head and base profiles. The tear-off fin enables compatibility with a range of companies aluminium framing systems. Frameless wedges are compatible with all JOINT series. The "Head&Base" gaskets are compatible with all the JOINT series gaskets.

• Keildichtungen: Sie halten das Glas und ermöglichen eine saubere und einfache Installation an Kopf- und Fußprofilen aus Aluminium. Die Abreißlamelle ermöglicht die Kompatibilität mit einer Reihe von Aluminiumrahmensystemen. Rahmenlose Keile sind mit allen JOINT-Serien kompatibel. Die „Head & Base“-Dichtungen sind mit allen JOINT-Dichtungen kompatibel.

• Joints de coin: ils tiennent le verre, permettant une installation simple et propre sur les profilés de tête et de base en aluminium. L'ailette déchirable permet la compatibilité avec une gamme de systèmes d'encadrement en aluminium de sociétés. Les coins sans cadre sont compatibles avec toutes les séries JOINT. Les joints «Head & Base» sont compatibles avec tous les joints de la série JOINT.

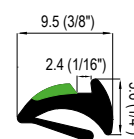
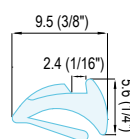
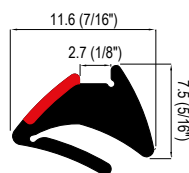
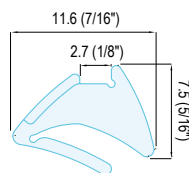

Articolo Code	Cuneo di spazio Wedging space	Vetro - Glass		L
		standard	laminated	
969291 ●	4-5mm (3/16")	10mm (3/8")	10.8mm	100m
663101 ●	4-5mm (3/16")	12mm (1/2")	12.8mm	100m

Articolo Code	Cuneo di spazio Wedging space	Vetro - Glass		L
		standard	laminated	
553692 ●	2-3mm (1/16"-1/8")	10mm (3/8")	10.8mm	200m
553691 ●	2-3mm (1/16"-1/8")	12mm (1/2")	12.8mm	200m



borchie / stud

NEUS

Alluminio / Aluminium - finiture / colors 31



4NB1

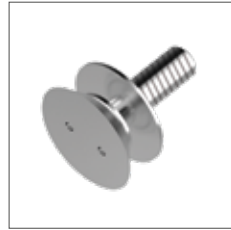

4NB2

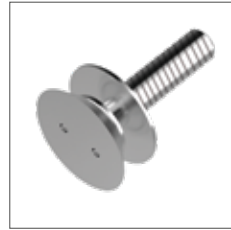

4NB3



4NB1a



4NB2a



4NB3a



4NB1b



4NB2b



4NB3b



4NB5

Sistemi di fissaggio per applicazioni vetro/vetro e vetro/muro; con diverse caratteristiche e fissaggi. Utili per creare connessioni e strutture complesse in vetro.

Sistemas de fijación para aplicaciones vidrio/vidrio y vidrio/pared, con varias características y ajustes. Útiles para conectar estructuras complejas de vidrio.

Fixing systems for glass/glass and glass/wall applications, with different features. Useful to create complex glass connections and structures.

Befestigungssysteme für Glas/ Glas und Glas / Wand Anwendungen; mit verschiedenen Merkmale und Befestigungen. Nützlich um Verbindungen und komplexe Glasstrukturen zu bauen.

Systèmes de fixation pour applications verre-verre et verre-mur; avec différentes caractéristiques et systèmes de fixation. Utile pour assembler des panneaux en verre entre eux et créer des structures complexes.



4NB1



- Borchia inox per vetro. 8-15mm filo vetro.
- Tornillo inoxidable para vidrio 8-15 mm hilo vidrio.
- Stud with stainless steel countersunk screw. 8-15mm glass.
- Flache Rosette mit Schraube aus Edelstahl mit Absenkung. 8-15mm Glas.
- Vis de fixation pour le verre en inox. Epaisseur de verre : 8-15mm.

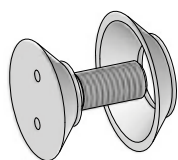
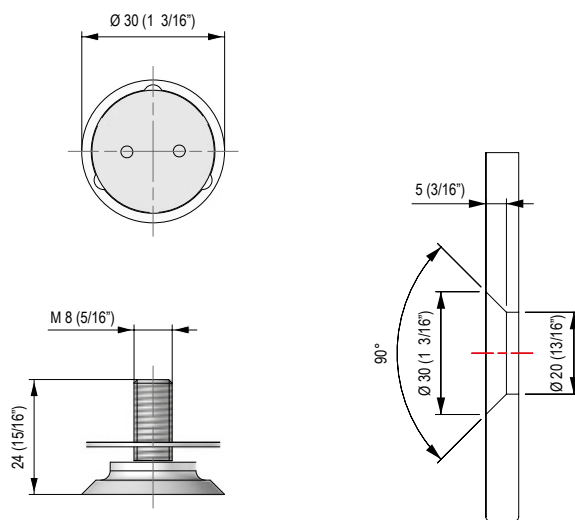
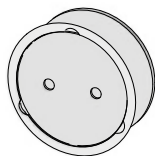

4NB1

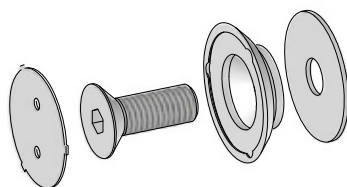

4NB1a

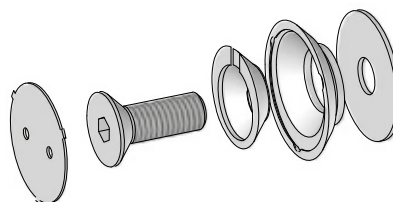

4NB1b

4NB2



- Borchia inox per vetro. 16-23mm filo vetro.
- Tornillo inoxidable para vidrio 16-23 mm hilo vidrio.
- Stud with stainless steel countersunk screw. 16-23mm glass.
- Flache Rosette mit Schraube aus Edelstahl mit Absenkung. 16-23mm Glas.
- Vis de fixation pour le verre en inox. Epaisseur de verre : 16-23mm.

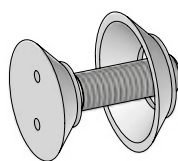
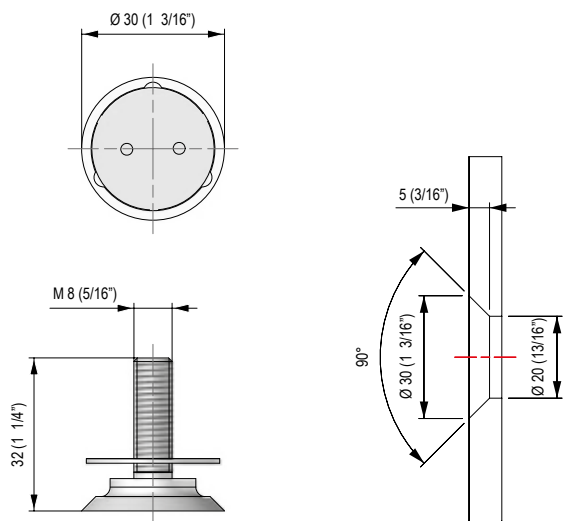
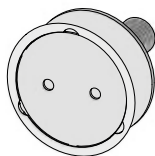

4NB2

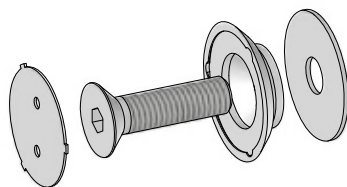

4NB2a

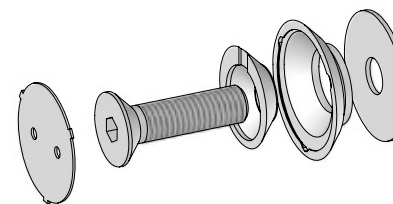

4NB2b

4NB3

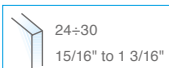

- Borchia inox per vetro. 24-30mm filo vetro.
- Tornillo inoxidable para vidrio 24-30 mm hilo vidrio.
- Stud with stainless steel countersunk screw. 24-30mm glass.
- Flache Rosette mit Schraube aus Edelstahl mit Absenkung. 24-30mm Glas.
- Vis de fixation pour le verre en inox. Epaisseur de verre : 24-30mm.

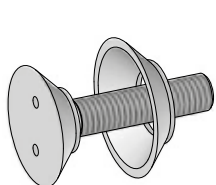
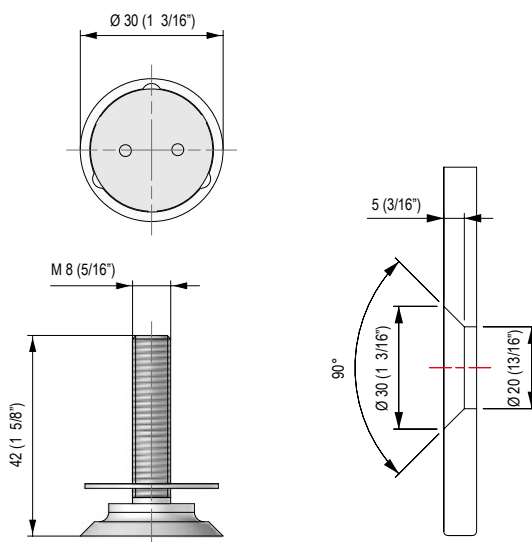
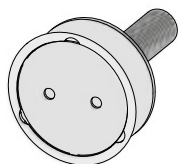

4NB3

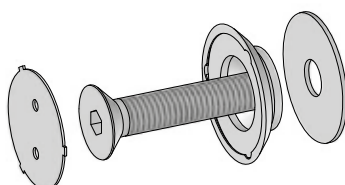

4NB3a

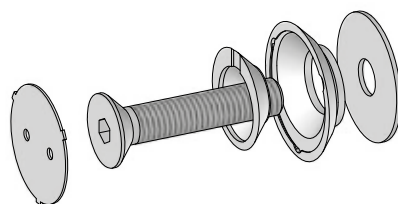

4NB3b

4NB5

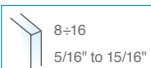

- Borchia esterna per vetro 8-16mm.
- Tornillo exterior para vidrio 8-16 mm.
- External stud for 8-16mm glass.
- Außenrosette für 8-16mm Glas.
- Vis de fixation externe pour le verre 8-16mm.

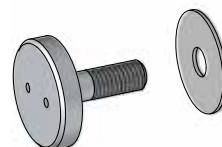
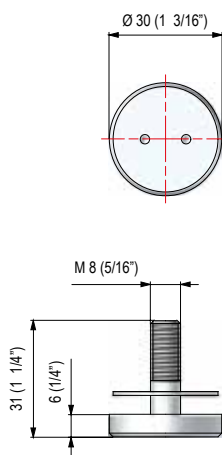

morsetti / clamps

Morsetti

Alluminio / Aluminium



finiture / colors
A70 02-05-14-15-16-17-40

Alluminio / Aluminium



finiture / colors
1710 02-05-14-15-16-17-40

Alluminio / Aluminium



finiture / colors
4040 02-05-13-14-15-16-17-40

Alluminio / Aluminium



finiture / colors
4041 02-05-13-14-15-16-17-40

Acciaio Inox / Stainless Steel



finiture / colors
490W10 31-32

Acciaio Inox / Stainless Steel



finiture / colors
493W10 31-32

Acciaio Inox / Stainless Steel



finiture / colors
496W10 31-32

Acciaio Inox / Stainless Steel



finiture / colors
499W10 31-32

Sono adatti per essere installati su parapetti, partizioni fisse, scale, pannellature di vario genere e in molte altre situazioni applicative. Sono disponibili in acciaio inox AISI 316 e in diverse finiture.

Aptos para instalaciones en barandillas, particiones, escaleras, varios tipos de paneles y más situaciones aplicativas. Hechas en acero AISI 316, son disponibles en distintos acabados.

Suitable for installation on parapets, partitions, various panel systems and many other applications. They are made of AISI 316 Stainless steel, and are available in different finishes.

Sie sind geeignet für den Einbau auf Glasgalerien, feste Trennwände, Treppen, Verkleidungen von verschiedenen Arten und in vielen anderen Anwendungssituationen. Sie sind erhältlich in Edelstahl AISI 316 und in verschiedenen Oberflächen.

Ces pinces à verre conviennent à une installation sur garde-corps, cloisons fixes, escaliers et dans de nombreuses autres applications. Elles sont disponibles en acier inoxydable AISI 316 et en différentes finitions.



A70

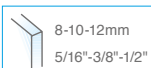

- Morsetto per vetri fissi.
- Abrazadera para vidrio fijo.
- Clamp for fixed glass panels.
- Glasplattenträger für starre Glassplatten.
- Pince pour panneaux en verre fixes.

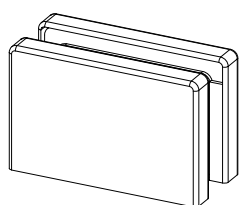
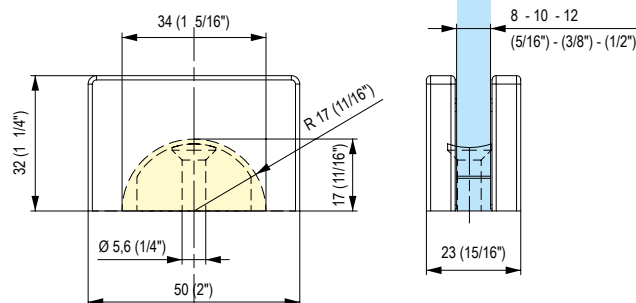

1710

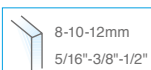

- Morsetto per vetri fissi.
- Abrazadera para vidrio fijo.
- Clamp for fixed glass panels.
- Glasplattenträger für starre Glassplatten.
- Pince pour panneaux en verre fixes.

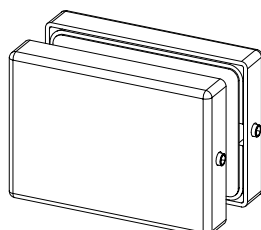
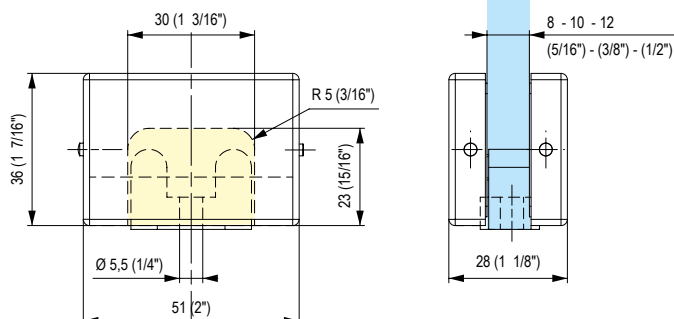

4040

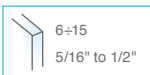

- Morsetto a leva per spessori da 6 a 15mm senza tacca nel vetro.
- Abrazadera para vidrio de 6 a 15 mm. Sin muesca en el vidrio.
- Lever clamp for 6 to 15mm. Without notch in the glass.
- Hebelglasplattenträger für 6 bis 15mm. Ohne Schnitt im Glas.
- Pince avec levier pour une épaisseur de 6 à 15mm, sans encoche dans le verre.

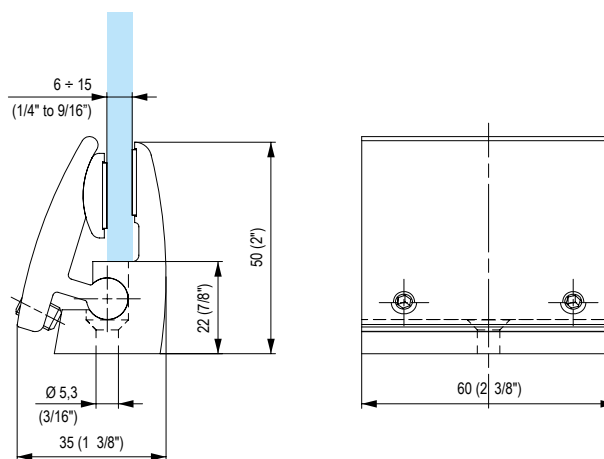
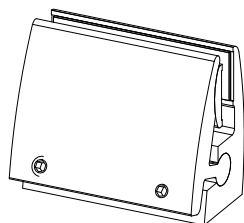

4041

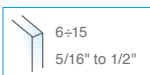

- Morsetto a leva per spessori da 6 a 15mm senza tacca nel vetro. Raggiatura a richiesta.
- Abrazadera de palanca para vidrio de 6 a 15 mm sin muesca en el vidrio. Radio de curvatura a petición.
- Lever clamp for 6 to 15mm. Without notch in the glass. Radius on request.
- Hebelglasplattenträger für 6 bis 15mm. Ohne Schnitt im Glas. Radius auf Wunsch.
- Pince avec levier pour une épaisseur de 6 à 15mm, sans encoche dans le verre. Base profilée

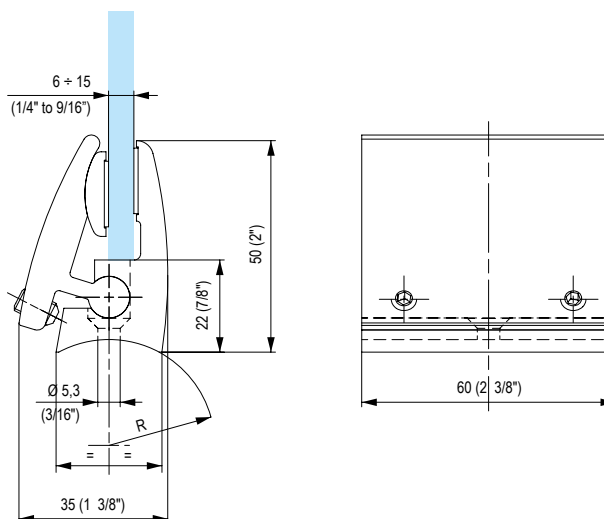
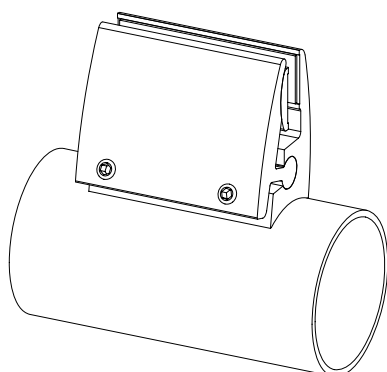

490W10

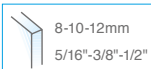

- Morsetto quadro 55x55. In acciaio inox Aisi 316
- Abrazadera cuadrada 55x55. En acero Aisi 316.
- Squared clamp 55x55. In stainless steel Aisi 316.
- Rechteckiger Glasklemhalter 55x55. Edelstahl Aisi 316.
- Pince carrée 55x55 en inox Aisi 316.

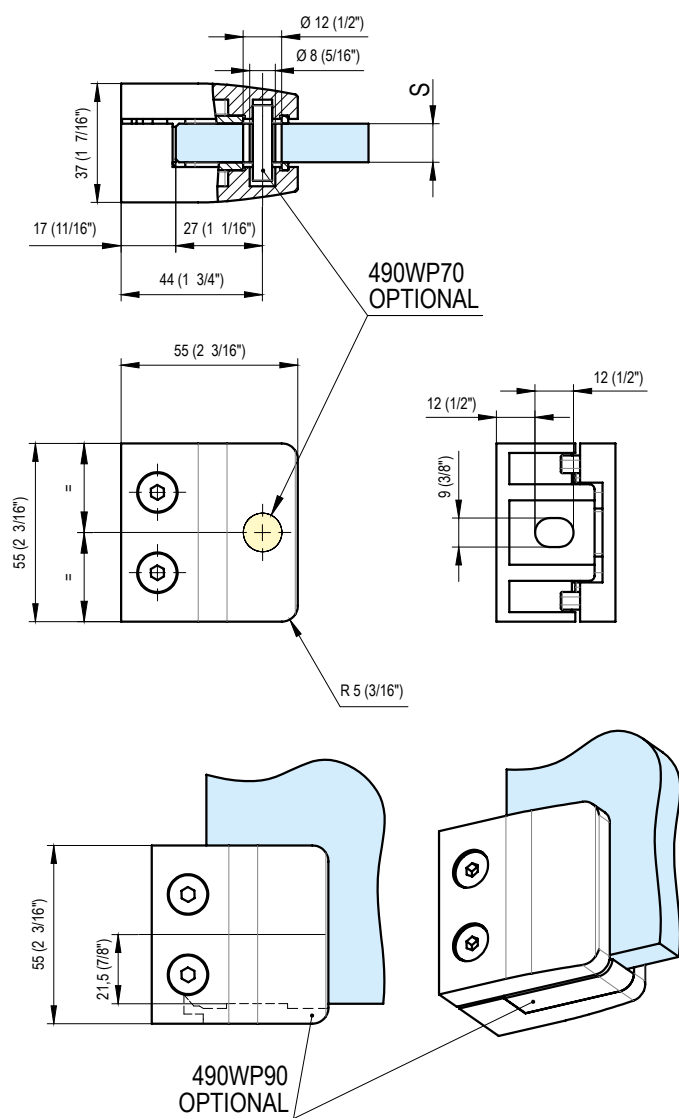
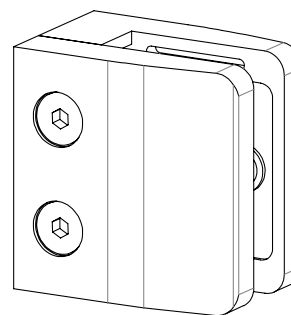

Compreso / Included

Corpo morsetto / Clamp Body

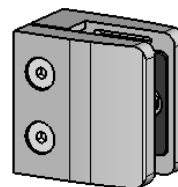

490W10



Da ordinare in base allo spessore del vetro
To be purchased according to the glass thickness

Guarnizioni / Gaskets

S= 8 mm
5/16"



490WJ08

S= 10 mm
3/8"



490WJ10

S= 12 mm
1/2"



490WJ12

OPTIONAL

Piatto di sicurezza / Safety plate



490WP90

Spina di sicurezza / Safety pin



490WP70

493W10

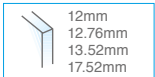

- Morsetto rettangolare 55x70. In acciaio inox Aisi 316.
- Abrazadera rectangular 55x70. En acero Aisi 316.
- Rectangular clamp 55x70. In stainless steel Aisi 316.
- Rechteckiger Glasklemmhalter 55x70. Edelstahl Aisi 316.
- Pince rectangulaire 55x70 en inox Aisi 316.

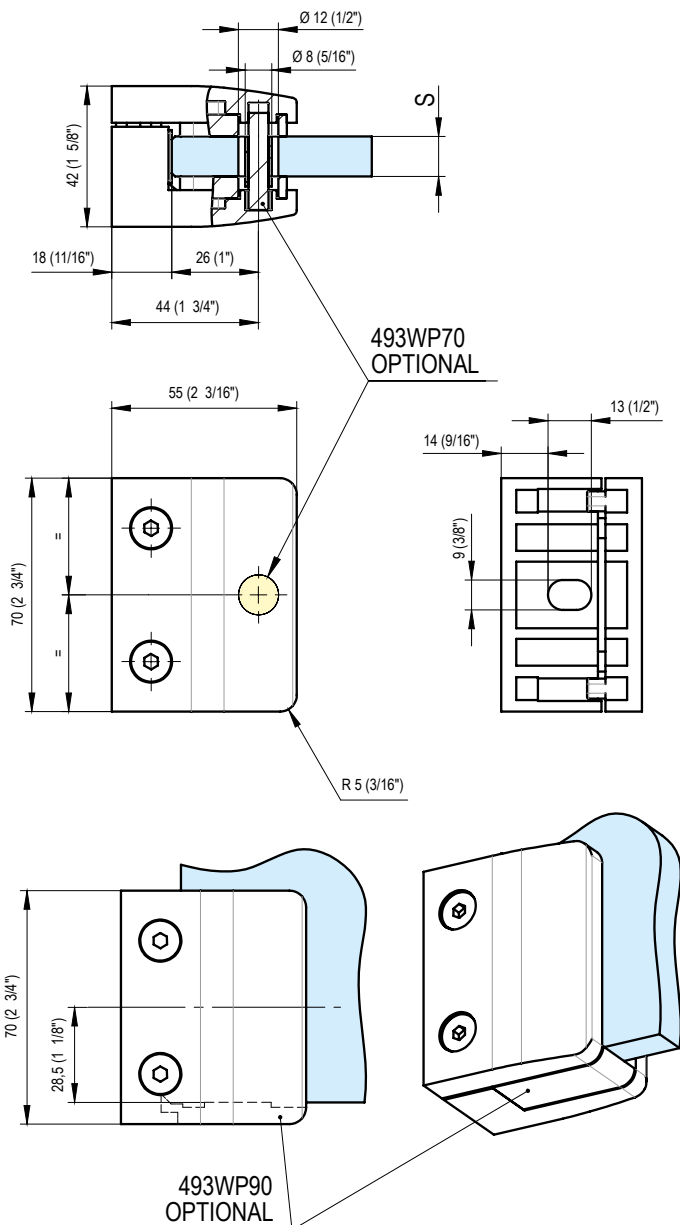
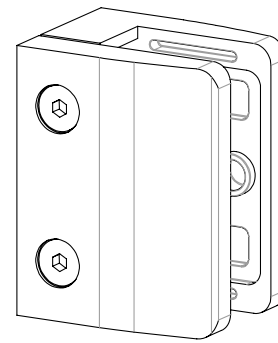

Compreso / Included

Corpo morsetto / Clamp Body



493W10



Da ordinare in base allo spessore del vetro
To be purchased according to the glass thickness

Guarnizioni / Gaskets

S= 12 mm
1/2"



493WJ12

S= 12.76 mm
1/2"



493WJ12.76

S= 13.52 mm
17/32"



493WJ13.52

S= 17.52 mm
11/16"



493WJ17.52

OPTIONAL

Piatto di sicurezza / Safety plate



493WP90

Spina di sicurezza / Safety pin



493WP70

496W10



- Morsetto tondo 45x63. In acciaio inox Aisi 316.
- Abrazadera redonda 45x63. En acero Aisi 316.
- Rounded clamp 45x53. In stainless steel Aisi 316.
- Abgerundeter Glasklemmhalter 45x63. Edelstahl Aisi 316.
- Pince ronde 45x63 en inox Aisi 316.

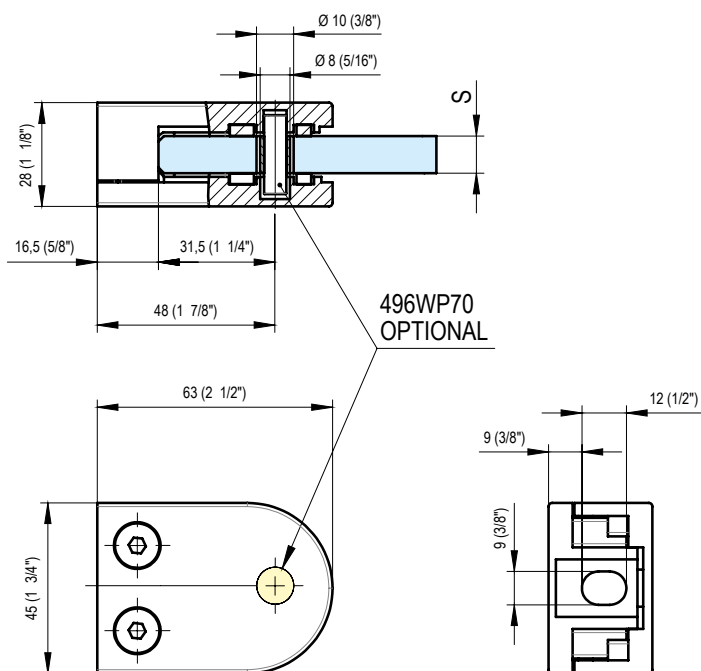
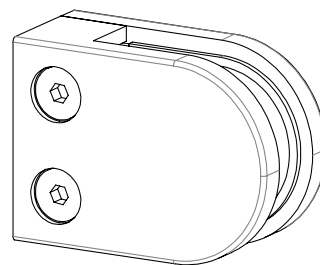

Compreso / Included

Corpo morsetto / Clamp Body



496W10

+

Da ordinare in base allo spessore del vetro
To be purchased according to the glass thickness

Guarnizioni / Gaskets

S= 8 mm
5/16"



496WJ08

S= 10 mm
3/8"



496WJ10

OPTIONAL

Spina di sicurezza / Safety pin



496WP70

499W10

20,76- 21,52mm
7/8"

- Morsetto rettangolare 60x70. In acciaio inox Aisi 316.
- Abrazadera rectangular 60x70. En acero Aisi 316.
- Rectangular clamp 60x70. In stainless steel Aisi 316.
- Rechteckiger Glasklemmhalter 60x70. Edelstahl Aisi 316.
- Pince carrée 60x70 en inox Aisi 316.

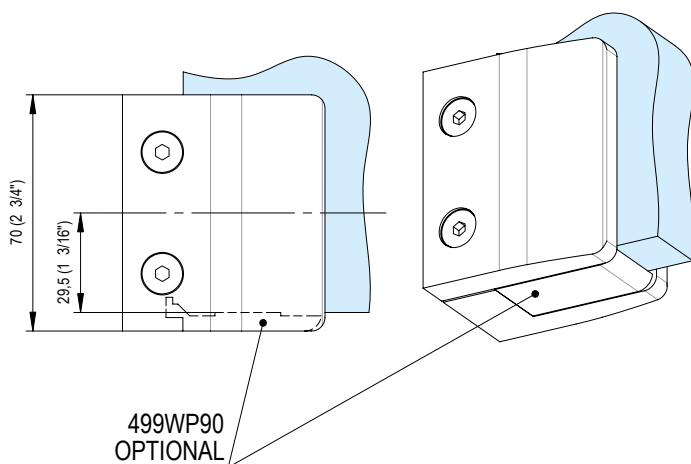
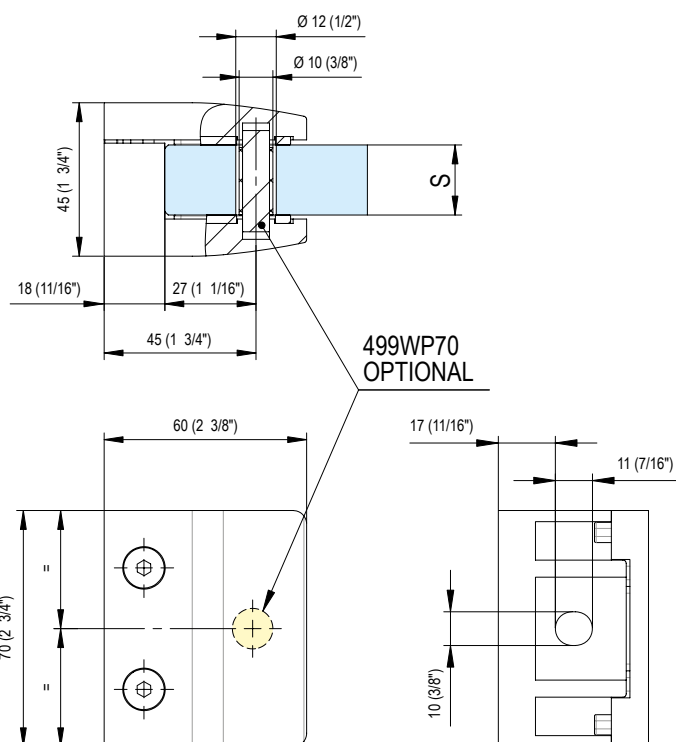
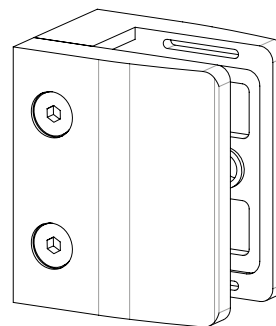

Compreso / Included

Corpo morsetto / Clamp Body



499W10

+

Da ordinare in base allo spessore del vetro
To be purchased according to the glass thickness

Guarnizioni / Gaskets

S= 20.76 mm



499WJ20.76

S= 21.52 mm
7/8"



499WJ21.52

OPTIONAL

Piatto di sicurezza / Safety plate



499WP90

Spina di sicurezza / Safety pin



499WP70

fissaggi / fastening

COVID SHIELD



K4040A

K4040B

I divisori si installano tra una postazione di lavoro e l'altra, così da mantenere la giusta distanza tra gli impiegati e rispettare la profilassi anti-contagio negli uffici. Nel caso in cui sia necessario fissare tramite foratura il divisore sulla scrivania, è possibile acquistare solo i morsetti senza piastre d'appoggio. Questi separatori consentono di proteggere gli utenti che operano nello stesso ambiente, impediscono il contatto diretto, riparano da starnuti, colpi di tosse e contatti accidentali.

Las particiones se aplican entre una posición de trabajo y la otra, para mantener la distancia correcta entre empleados y respetar la profilaxis contra infecciones en las oficinas. Si es necesario atornillar las particiones directamente al escritorio, es posible suministrar solamente las abrazadoras sin bases. Los separadores consenten proteger los usuarios operantes en el mismo ambiente, impiden contactos directos y amparan de estornudos, golpes de tos y contactos accidentales.

The partitions are installed between one workstation and the other, in order to maintain the correct distances between employees and respect the anti-infection measures in the offices. If it is necessary to screw the partition to the desk, it is possible to purchase the clamps only, without the bases. These dividers allow to protect the users ope-

Acciaio Inox / Stainless Steel - finiture / colors 02-05-13-14

rating in the same environment, preventing people from direct contact with each other. They also shield users from sneezes, cough and accidental contacts.

Die Trennwände werden zwischen einer Arbeitsstation und einer anderen installiert, um den richtigen Abstand zwischen den Mitarbeitern einzuhalten und die Ansteckungsschutzprophylaxe in den Büros zu respektieren. Falls der Teiler auf dem Schreibtisch befestigt werden muss, können nur die Klemmen ohne Stützplatten gekauft werden. Diese Separatoren schützen Benutzer, die in derselben Umgebung arbeiten, und verhindern direkten Kontakt, Schutz vor Niesen, Husten und versehentlichem Kontakt.

Les séparateurs sont installés entre un poste de travail et un autre, afin de maintenir la bonne distance entre les employés et de respecter la prophylaxie anti-contagion dans les bureaux. Dans le cas où il est nécessaire de fixer le diviseur sur le bureau par perçage, il est possible d'acheter uniquement les pinces sans plaques de support. Ces séparateurs aident à protéger les utilisateurs qui opèrent dans le même environnement, à prévenir les contacts directs, à l'abri des éternuements, de la toux et des contacts accidentels.



K4040A

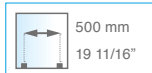
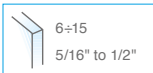

- Morsetto per separatore Covid. Piastra base 120mm.
- Abrazadora para partición COVID – base 120mm.
- Clamp for COVID partition – base 120mm.
- Zwinge für COVID Trennwand – Fuß 120mm.
- Pince pour séparateur COVID – base 120mm.

Corner Optional

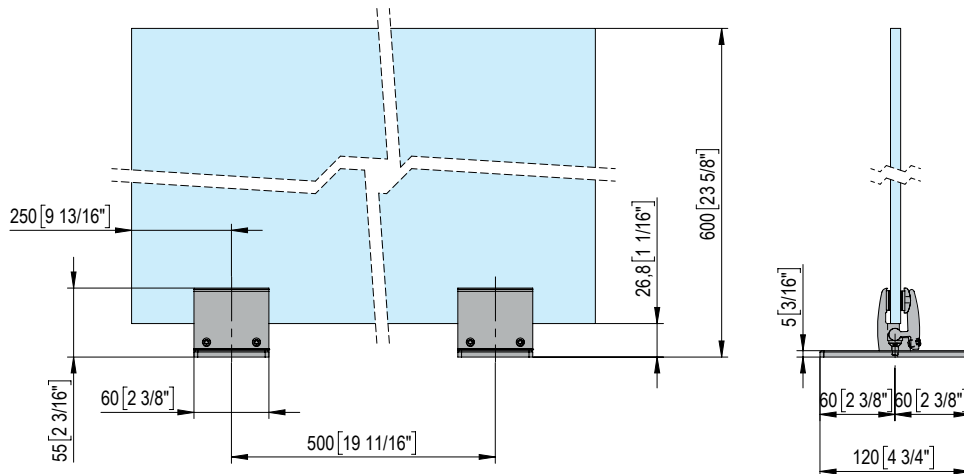
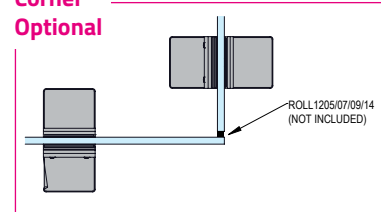

K4040B

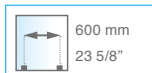
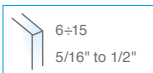

- Morsetto per separatore Covid. Piastra base 200mm.
- Abrazadora para partición COVID – base 200mm.
- Clamp for COVID partition – base 200mm.
- Zwinge für COVID Trennwand – Fuß 200mm.
- Pince pour séparateur COVID – base 200mm.

Corner Optional

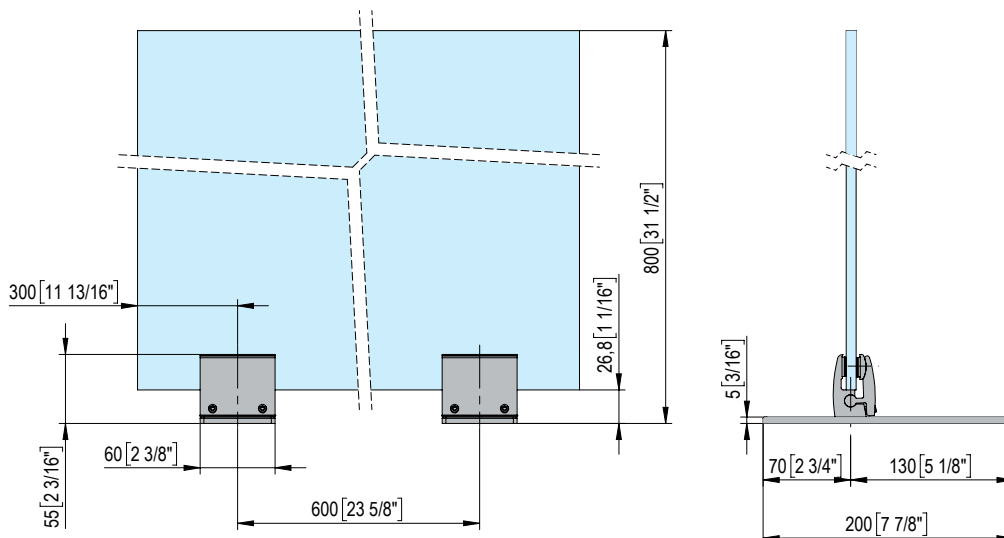
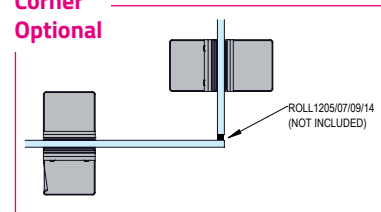

distanziali / spacers

serie 4360



4360

4360i



00 10 20 p.462



Alluminio / Aluminium | Acciaio Inox / Stainless Steel - finiture / colors 31-32

Distanziali per parapetti, di design minimale, con struttura e collare disponibili in alluminio anodizzato o in acciaio inox per parapetti per esterni. A corredo dei parapetti è disponibile il corrimano in acciaio inox satinato; la cui gamma comprende anche connettori di 90° e 180°, tutti forniti di protezioni e inserti in gomma per l'installazione.

Distanciales para barandas, con un diseño esencial, de aluminio anodizado o acero inoxidable, material apto para aplicaciones exteriores. La gama se completa con pasamano en acero y conectadores a 90° y 180°, todos incluyendo protecciones y gomas para la instalación.

Spacers for parapets, featured with essential design, made of anodized aluminum or stainless steel, for external applications. The range is

completed with stainless steel handrails and 90° and 180° connection items, which include protective devices and rubbers.

Brüstungshalter für Glasgeländer minimalistisches Design, mit Struktur und Kragen erhältlich in eloxiertem Aluminium oder Edelstahl. Der Handlauf in Edelstahl wird mit den Glasgeländer geliefert. Das Sortiment umfasst auch 90° und 180° Anschlüsse versehen mit Schutzvorrichtungen und Gummieinsätzen für die Installation.

Points nez de dalle pour garde-corps au design minimaliste, en aluminium anodisé ou en acier inoxydable pour des applications extérieures. La gamme comprend également des mains courantes en acier inoxydable et des connecteurs 90° et 180°, tous fournis avec des protections et des inserts en caoutchouc pour l'installation.



4360

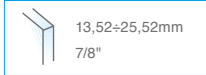

- Distanziale in alluminio per parapetti.
- Distanciador en aluminio para baranda.
- Aluminium spacer for railings.
- Distanzstück aus Aluminium für Balustrade.
- Point nez de dalle en aluminium pour garde-corps.



4360i

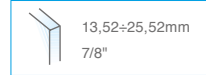

- Distanziale in acciaio inox per parapetti.
- Distanciador en acero inoxidable para baranda.
- Stainless-steel spacer for railings.
- Distanzstück aus Edelstahl für Balustrade.
- Point nez de dalle en acier inox pour garde-corps.

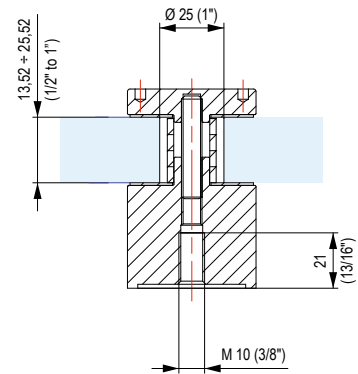
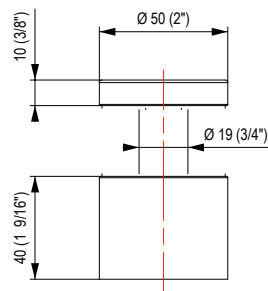
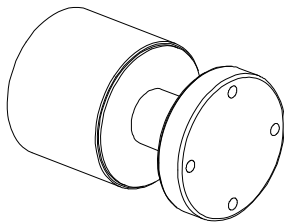

ESEMPIO DI APPLICAZIONE - EJEMPLO DE APLICACIÓN - EXAMPLE OF APPLICATION BEISPIEL VON ANWENDUNG - EXEMPLE D'APPLICATION

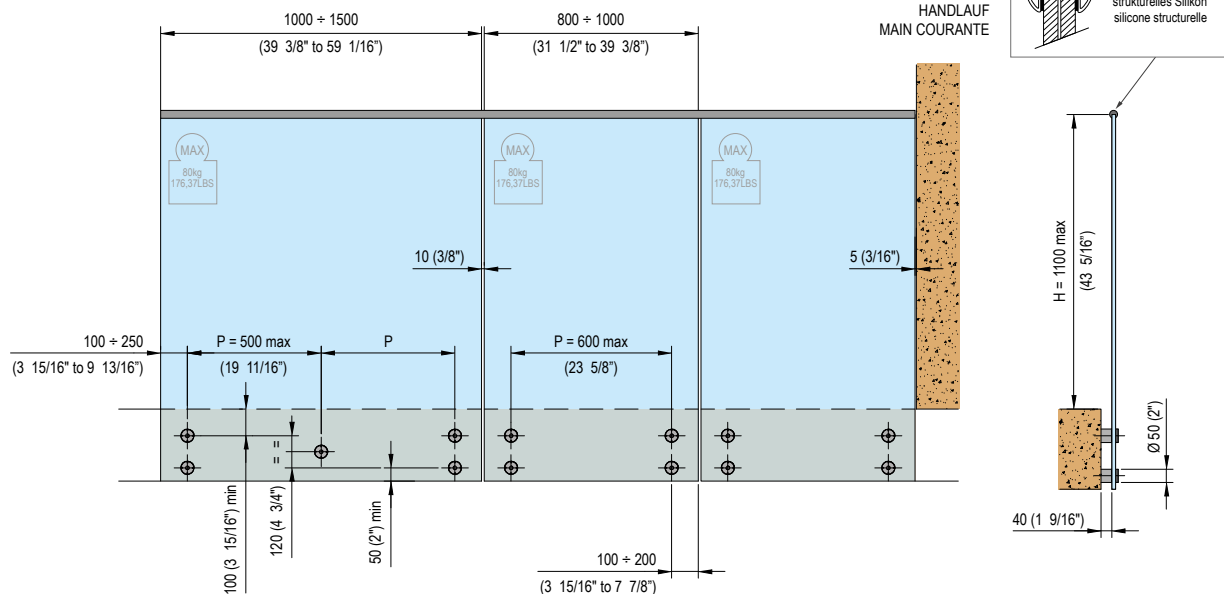

ATTENZIONE: L'utilizzo dell'applicazione senza il corrimano non risponde ai criteri di sicurezza previsti dalle normative vigenti in Italia e della nuova normativa UNI 11678:2017.
 ¡CUIDADO! El uso de esta aplicación sin el pasamano no responde a los criterios de seguridad contemplados en las normativas en vigor en Italia y en la nueva normativa UNI 11678:2017.
 CAUTION: Using this application without handrail does not comply with the security criteria currently in force in Italy and with the new regulation UNI 11678:2017.
 ACHTUNG: Die Anwendungsnutzung ohne Handlauf entspricht nicht die Sicherheitskriterien gemäß den geltenden Vorschriften in Italien und die neue Regulierung UNI 11678 :2017.
 ATTENTION: l'utilisation de l'application sans la main courante ne répond pas aux critères de sécurité prévus par les réglementations en vigueur en Italie et par la nouvelle législation UNI 11678 :2017.

L'azienda declina ogni responsabilità relativa alla installazione e rimanda la stessa all'installatore - La empresa se exime de cualquier responsabilidad relativa a la instalación y se traspa a la misma al instalador - The company waives any responsibility for the installation; the installer is liable for the installation. - Die Firma lehnt jede Verantwortung betreffend der Installation ab. Die Verantwortung ist zum Lasten des Monteurs - La société décline toute responsabilité pour l'installation; l'installateur est responsable de l'installation.

distanziali / spacers

serie 432W

regolabili - adjustable



432W



00 10 20 p.462



Acciaio Inox / Stainless Steel - finiture / colors 31-32

Distanziale Antishock in acciaio inox, con sistema interno di ammortizzazione degli urti. Ideale per parapetti soggetti a forti sollecitazioni. A corredo dei parapetti è disponibile il corrimano in acciaio inox satinato; la cui gamma comprende anche connettori di 90° e 180°, tutti forniti di protezioni e inserti in gomma per l'installazione.

Riosta anti choque en acero, con sistema interior para amortiguar los impactos. Ideal para baranda sojetas a esfuerzos. En apoyo a las barandillas, es disponible también el pasamanos en acero inoxidable satinado, cuya gama se completa con conectores 90° y 180°, los cuales incluyen protecciones e piezas en goma para la instalación.

Spacer Antishock made of stainless steel, with internal damping system of the blows. Suitable for railings subjected to high stress. To accompany the railings, is also available the satin stainless steel handrail, whose ran-

ge includes 90° and 180° connectors, with their protection devices.

Antishock Distanzstück aus Edelstahl mit Innensystem von Stoßdämpfung. Ideal für starke stresspflichtige Geländer. Der Handlauf in Edelstahl wird mit den Glasgeländer geliefert. Das Sortiment umfasst auch 90° und 180° Anschlüsse versehen mit Schutzvorrichtungen und Gummieinsätzen für die Installation.

Points nez de dalle Antishock en acier inoxydable, avec système d'amortissement. Idéal pour les garde-corps soumis à une tension élevée. Pour accompagner les garde-corps, des mains courantes en acier inoxydable satiné sont disponibles; dont la gamme comprend également des connecteurs 90° et 180°, tous fournis avec protecteurs et inserts en caoutchouc pour l'installation.



432W40



432W41



432W42



Spessori vetro differenti su richiesta
Other glass thickness on order when ordering

- Distanziale in acciaio inox per parapetti.
- Distanciador en acero inoxidable para baranda.
- Stainless-steel spacer for railings.
- Distanzstück aus Edelstahl für Balustrade.
- Point nez de dalle en acier inox pour garde-corps.

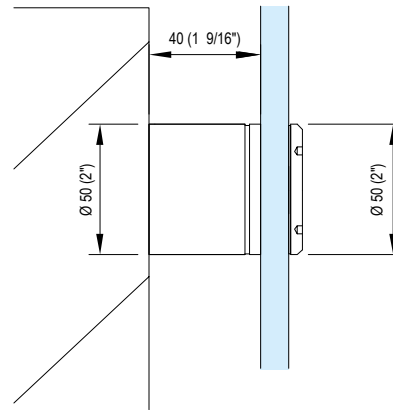
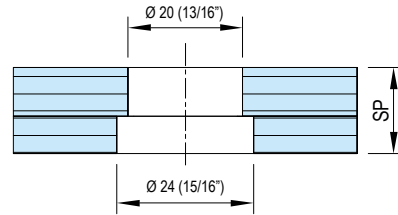

ESEMPIO DI APPLICAZIONE - EJEMPLO DE APLICACIÓN - EXAMPLE OF APPLICATION BEISPIEL VON ANWENDUNG - EXEMPLE D'APPLICATION

CORRIMANO
PASAMANO
HANDRAIL
HANDLAUF
MAIN COURANTE

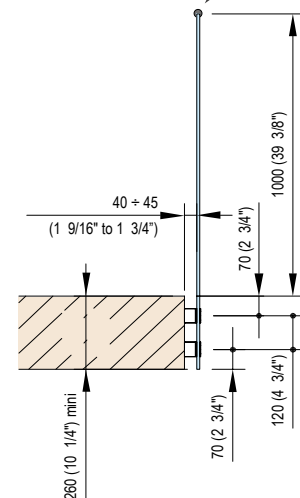
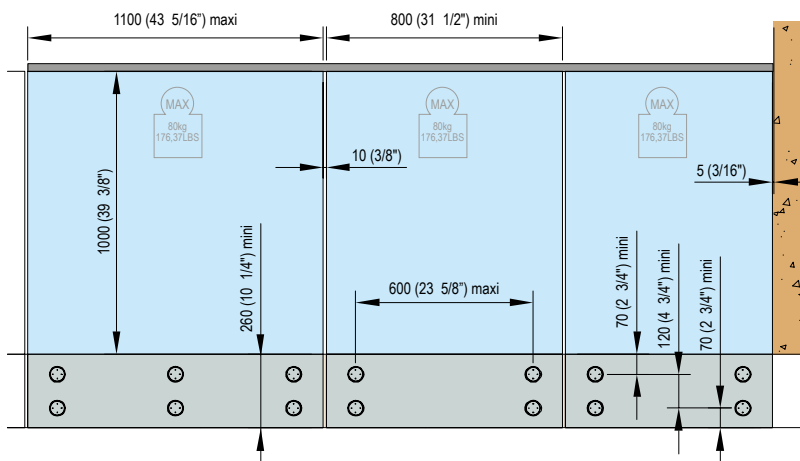
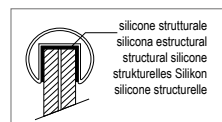

ATTENZIONE: L'utilizzo dell'applicazione senza il corrimano non risponde ai criteri di sicurezza previsti dalle normative vigenti in Italia e della nuova normativa UNI 11678:2017.
¡CUIDADO!: El uso de esta aplicación sin el pasamano no responde a los criterios de seguridad contemplados en las normativas en vigor en Italia y en la nueva normativa UNI 11678:2017.
CAUTION!: Using this application without handrail does not comply with the security criteria currently in force in Italy and with the new regulation UNI 11678:2017.
ACHTUNG: Die Anwendungsnutzung ohne Handlauf entspricht nicht die Sicherheitskriterien gemäß den geltenden Vorschriften in Italien und die neue Regulierung UNI 11678 :2017.
ATTENTION: l'utilisation de l'application sans la main courante ne répond pas aux critères de sécurité prévus par les réglementations en vigueur en Italie et par la nouvelle législation UNI 11678 :2017.

L'azienda declina ogni responsabilità relativa alla installazione e rimanda la stessa all'installatore - La empresa se exime de cualquier responsabilidad relativa a la instalación y se traspa a la misma al instalador - The company waives any responsibility for the installation; the installer is liable for the installation. - Die Firma lehnt jede Verantwortung betreffend der Installation ab. Die Verantwortung ist zum Lasten des Monteurs - La société décline toute responsabilité pour l'installation; l'installateur est responsable de l'installation.

punti a muro / wall points

serie 430W

regolabili - adjustable



430W



431W

Punti a muro regolabili con struttura e borchia in acciaio inox per fissare targhe e pannelli in vetro. Disponibili in 6 differenti lunghezze.

Puntos a pared ajustables con estructuras y tacón en acero: para ajustar placas y tabiques al vidrio. A disposición en 6 diferentes tamaños.

Adjustable wall points with structure and stud made of stainless steel in order to fix plates and panels made of glass. Available in 6 different lengths.

Acciaio Inox / Stainless Steel - finiture / colors 31-32

Einstelbare Wandpunkte mit Struktur und Befestigung aus Edelstahl für die Feststellung von Schilden und Glaswandplatten. In 6 verschiedenen Längen verfügbar.

Points nez de dalle en acier inoxydable pour fixer plaques et panneaux en verre. Disponibles en six longueurs différentes.



430W *

- Punti a muro con borchia a filo vetro in acciaio inox.
- Puntos a pared con tachòn hilo vidrio en acero.
- Stainless-steel wall points with stud of the end part of the glass.
- Wandpunkte Befestigung im Glaslot aus Edelstahl.
- Points nez de dalle avec vis de fixation fraisée en inox.

431W *

- Punti a muro con borchia esterna in acciaio inox.
- Puntos a pared con tachòn exterior en acero.
- Stainless-steel wall points with external stud.
- Wandpunkte Ausserbefestigung aus Edelstahl.
- Points nez de dalle avec vis de reliure en inox.

*

Spessori vetro e lunghezze vedere tabella sotto
Glass thickness and length see the table below

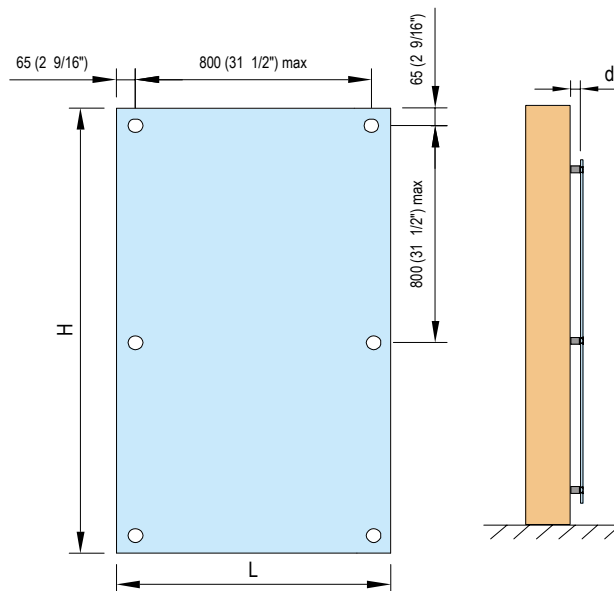

SCHEMA ESPLOSO - LAYOUT DRAWING	A	SP SPESSORE VETRO GLASS THICKNESS	FORATURA - DRILLING	CODICE - CODE		
<p>BORCHIA FILO VETRO TACHÓN HILO VIDRIO STUD OF THE END PART OF THE GLASS BEFESTIGUNG IM GLASLOT AVEC VIS FRAISÉE</p>	20	8÷12 5/16" to 15/32" 12.76÷17.52 1/2" to 11/16" 19÷22 3/4" to 55/64"		430W20 430W21 430W22		
	30	8÷12 5/16" to 15/32" 12.76÷17.52 1/2" to 11/16" 19÷22 3/4" to 55/64"		430W30 430W31 430W32		
	40	8÷12 5/16" to 15/32" 12.76÷17.52 1/2" to 11/16" 19÷22 3/4" to 55/64"		430W40 430W41 430W42		
	50	8÷12 5/16" to 15/32" 12.76÷17.52 1/2" to 11/16" 19÷22 3/4" to 55/64"		430W50 430W51 430W52		
	70	8÷12 5/16" to 15/32" 12.76÷17.52 1/2" to 11/16" 19÷22 3/4" to 55/64"		430W70 430W71 430W72		
	100	8÷12 5/16" to 15/32" 12.76÷17.52 1/2" to 11/16" 19÷22 3/4" to 55/64"		430W10 430W11 430W12		
	<p>BORCHIA ESTERNA TACHÓN EXTERIOR EXTERNAL STUD AUSSERBEFESTIGUNG AVEC VIS CYLINDRIQUE</p>	20		8÷12 5/16" to 15/32" 12.76÷17.52 1/2" to 11/16" 19÷22 3/4" to 55/64"		431W20 431W21 431W22
		30		8÷12 5/16" to 15/32" 12.76÷17.52 1/2" to 11/16" 19÷22 3/4" to 55/64"		431W30 431W31 431W32
40		8÷12 5/16" to 15/32" 12.76÷17.52 1/2" to 11/16" 19÷22 3/4" to 55/64"	431W40 431W41 431W42			
50		8÷12 5/16" to 15/32" 12.76÷17.52 1/2" to 11/16" 19÷22 3/4" to 55/64"	431W50 431W51 431W52			
70		8÷12 5/16" to 15/32" 12.76÷17.52 1/2" to 11/16" 19÷22 3/4" to 55/64"	431W70 431W71 431W72			
100		8÷12 5/16" to 15/32" 12.76÷17.52 1/2" to 11/16" 19÷22 3/4" to 55/64"	431W10 431W11 431W12			

fissaggi / fastening

serie 02

regolabili - adjustable



02 26 20



02 26 21



02 28 20



02 29 20



02 29 21

Acciaio Inox / Stainless Steel - finiture / colors 31-32

Sistemi di fissaggio per applicazioni vetro/vetro e vetro/muro; con diverse caratteristiche e fissaggi. Utili per creare connessioni e strutture complesse in vetro.

Ajustes para soluciones vidrio - vidrio y vidrio - pared, con diferentes características y ajustes. Provechosos para crear conexiones y "armaduras" en vidrio.

Fastening systems for glass to glass and glass to wall applications; with different features and fixing. Useful to create connections and big structures made of glass.

Feststellungssysteme für Anwendungen Glas/Glas und Glas/Wand; mit verschiedenen Kennzeichen und Feststellungen. Für Verbindungen und komplexe Glasstrukturen nützlich.

Renvois d'angle pour des applications verre/verre ou verre/mur ; avec différentes caractéristiques et réglages. Très utiles pour créer connections et grandes structures en verre. Disponibles en acier inoxydable AISI 316 et différentes finitions.



02 26 20



- Angolare regolabile vetro-vetro
- Angolar ajustable vidrio-vidrio
- Adjustable angular glass to glass
- Einstellbares Winkelprofil Glas-Glas
- Renvoi d'angle verre-verre modulable

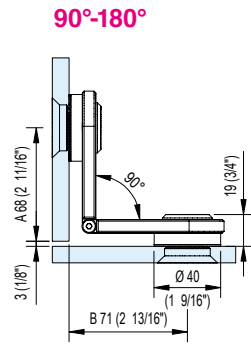

FORATURA - DRILLING

SP SPESSORE VETRO
GLASS THICKNESS

CODICE - CODE

8 ÷ 12 mm 5/16" to 15/32"	02 26 20 06 11 14
12,76 ÷ 17,52 mm 1/2" to 11/16"	02 26 20 06 11 20
19 ÷ 22 mm 3/4" to 55/64"	02 26 20 06 11 26

8 ÷ 12 mm 5/16" to 15/32"	02 26 20 06 24 22
12,76 ÷ 17,52 mm 1/2" to 11/16"	02 26 20 06 24 28
19 ÷ 22 mm 3/4" to 55/64"	02 26 20 06 24 32

02 26 21

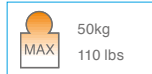

- Angolare regolabile muro-vetro
- Angolar ajustable pared-vidrio
- Adjustable angular wall to glass
- Einstellbares Winkelprofil Wand-Glas
- envoi d'angle mur-verre modulable

90°-180°

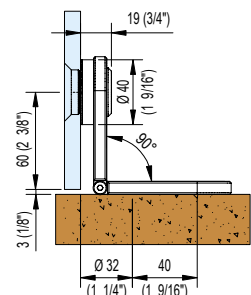

FORATURA - DRILLING

SP SPESSORE VETRO
GLASS THICKNESS

CODICE - CODE

8 ÷ 12 mm 5/16" to 15/32"	02 26 21 06 11 14
12,76 ÷ 17,52 mm 1/2" to 11/16"	02 26 21 06 11 20
19 ÷ 22 mm 3/4" to 55/64"	02 26 21 06 11 26

8 ÷ 12 mm 5/16" to 15/32"	02 26 21 06 24 22
12,76 ÷ 17,52 mm 1/2" to 11/16"	02 26 21 06 24 28
19 ÷ 22 mm 3/4" to 55/64"	02 26 21 06 24 32

02 28 20

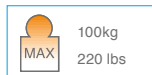

- Fissaggio vetro-vetro in linea
- Ajuste vidrio - vidrio en línea
- Glass to glass fastening on 180° line
- Gerade Feststellung Glas-Glas
- Renvoi d'angle verre-verre plat.

180°

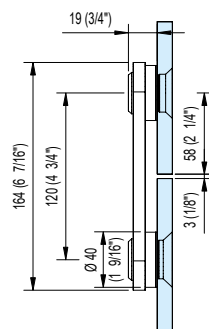

FORATURA - DRILLING

SP SPESSORE VETRO
GLASS THICKNESS

CODICE - CODE

8 ÷ 12 mm 5/16" to 15/32"	02 28 20 06 11 14
12,76 ÷ 17,52 mm 1/2" to 11/16"	02 28 20 06 11 20
19 ÷ 22 mm 3/4" to 55/64"	02 28 20 06 11 26

8 ÷ 12 mm 5/16" to 15/32"	02 28 20 06 24 22
12,76 ÷ 17,52 mm 1/2" to 11/16"	02 28 20 06 24 28
19 ÷ 22 mm 3/4" to 55/64"	02 28 20 06 24 32

02 29 20

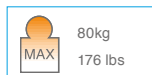

- Angolare fisso 90° vetro/vetro
- Angolar fijo 90° vidrio-vidrio
- Fixed angular at 90° glass to glass
- Festes Winkelprofil 90° Glas-Glas
- Renvoi d'angle fixe 90° verre-verre.

90°

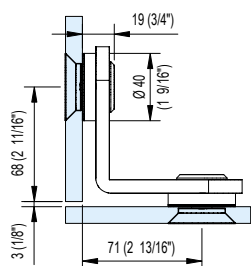

FORATURA - DRILLING

SP SPESSORE VETRO
GLASS THICKNESS

CODICE - CODE

8 ÷ 12 mm 5/16" to 15/32"	02 29 20 06 11 14
12,76 ÷ 17,52 mm 1/2" to 11/16"	02 29 20 06 11 20
19 ÷ 22 mm 3/4" to 55/64"	02 29 20 06 11 26

8 ÷ 12 mm 5/16" to 15/32"	02 29 20 06 24 22
12,76 ÷ 17,52 mm 1/2" to 11/16"	02 29 20 06 24 28
19 ÷ 22 mm 3/4" to 55/64"	02 29 20 06 24 32

02 29 21

90°

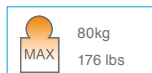

- Angolare fisso 90° muro/vetro
- Angolar fijo 90° pared-vidrio
- Fixed angular at 90° wall to glass
- Festes Winkelprofil 90° Wand-Glas
- Renvoi d'angle fixe 90° mur-verre.

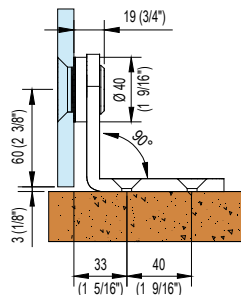

FORATURA - DRILLING

SP SPESSORE VETRO
GLASS THICKNESS

CODICE - CODE

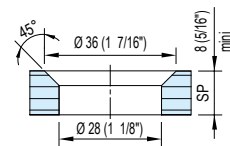

8 ÷ 12 mm
5/16" to 15/32"
12,76 ÷ 17,52 mm
1/2" to 11/16"
19 ÷ 22 mm
3/4" to 55/64"

02 29 21 06 11 14

02 29 21 06 11 20

02 29 21 06 11 26

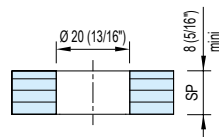

8 ÷ 12 mm
5/16" to 15/32"
12,76 ÷ 17,52 mm
1/2" to 11/16"
19 ÷ 22 mm
3/4" to 55/64"

02 29 21 06 24 22

02 29 21 06 24 28

02 29 21 06 24 32

02 29 22

90°

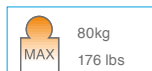

- Angolare autoportante fisso 90° vetro/vetro
- Angolar autoportante fijo 90° vidrio-vidrio
- Self-supporting fixes angular fitting 90° glass-to-glass.
- Festes selbsttragendes Winkelprofil 90° Glas-Glas
- Renvoi d'angle autoportant fixe 90° verre-verre.

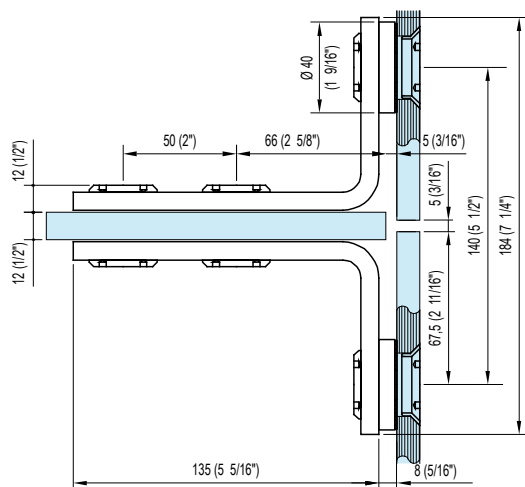

FORATURA - DRILLING

SP SPESSORE VETRO
GLASS THICKNESS

CODICE - CODE

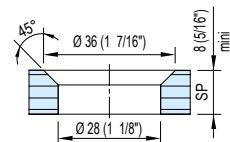

8 ÷ 12 mm
5/16" to 15/32"
12,76 ÷ 17,52 mm
1/2" to 11/16"
19 ÷ 22 mm
3/4" to 55/64"

02 29 22 06 11 14

02 29 22 06 11 20

02 26 22 06 11 26

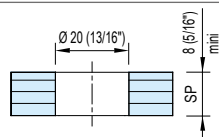

8 ÷ 12 mm
5/16" to 15/32"
12,76 ÷ 17,52 mm
1/2" to 11/16"
19 ÷ 22 mm
3/4" to 55/64"

02 29 22 06 24 22

02 29 22 06 24 28

02 29 22 06 24 32

Ricordare di indicare lo spessore del vetro per il sostegno della coppia
Remember to state the glass thickness for the brace

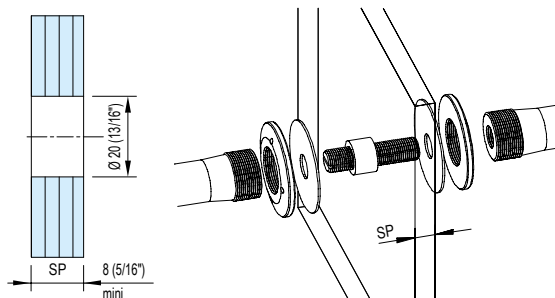

ATTENZIONE! CAUTION!

Il pannello di vetro non è posato sul pavimento.
Il suo peso è supportato dai pezzi. Massimo 80 kg.

The glass panel is not laid on the floor.
Its weight is supported by the pieces. Maximum 80 kg.

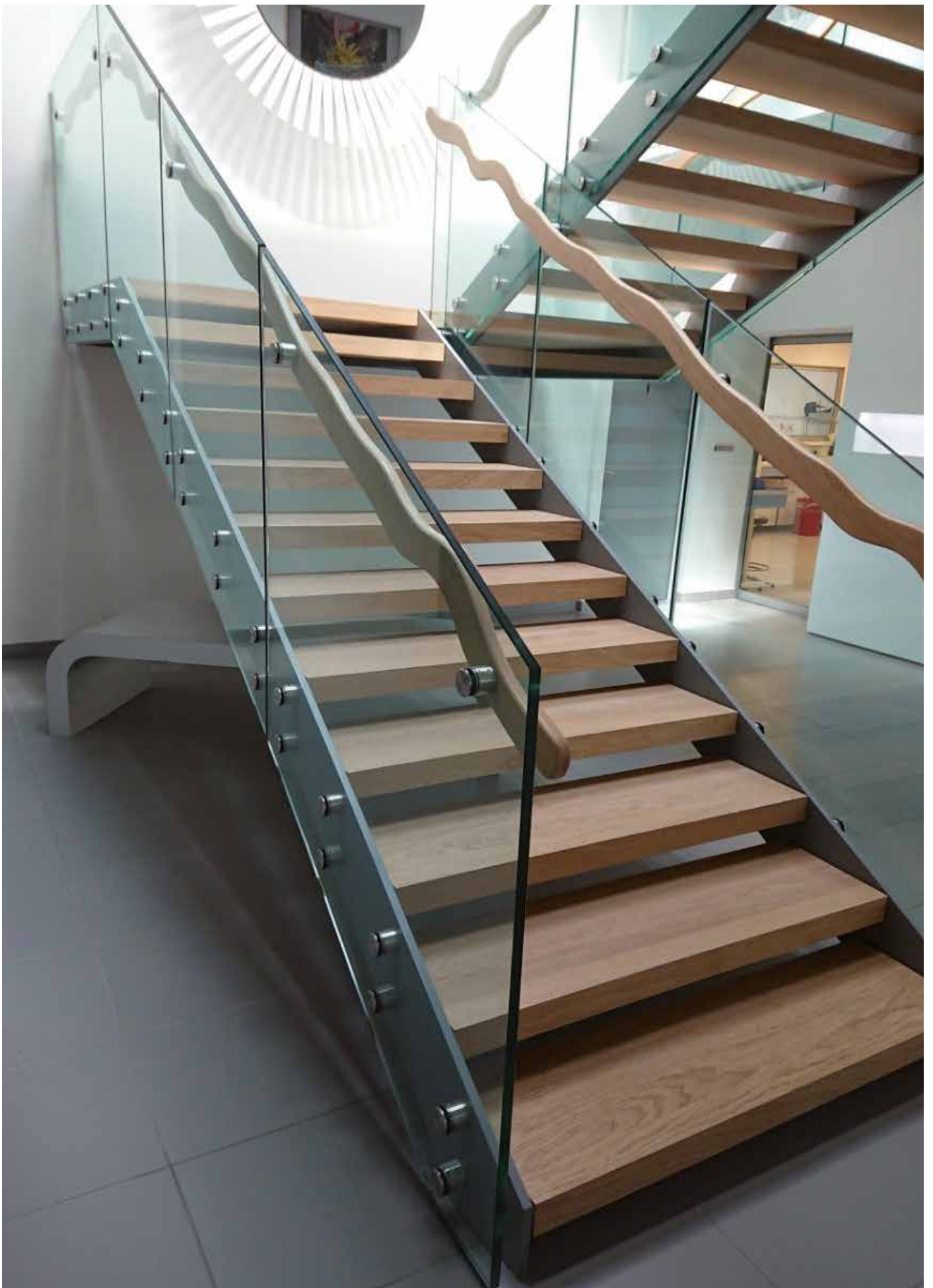





PORTE SCORREVOLI

Puertas Correderas
Sliding Doors
Schiebetürsysteme
Portes Coulissantes

scorrevoli / sliding

system FLUIDO+

Alluminio / Aluminium - finiture / colors 02-05-13

Fluido+ 70, 110 e 150 sono i nuovi sistemi scorrevoli compatti per porte in vetro temperato. Fluido+ è adatto per applicazioni: a muro, a soffitto e falso soffitto. Nella versione a falso soffitto il meccanismo è completamente nascosto. Fluido+ integra il nuovo sistema Colcom di chiusura progressiva "Colcom Progressive Closing System" (CPCS); combinando il design minimale alla massima funzionalità. Si installa facilmente e velocemente in ambienti sia residenziali che commerciali. Disponibile la versione per porte in legno.

Fluido+ 70, 110 y 150 son los nuevos sistemas compactos para puertas de vidrio templado. Fluido+ es adecuado para aplicaciones de pared, techo y falso techo. En la versión para falso techo, el mecanismo está completamente oculto. Fluido+ integra el nuevo sistema de cierre progresivo Colcom ("Colcom Progressive Closing System" - CPCS) y combina un diseño minimalista con la máxima funcionalidad. Se puede instalar fácil y rápidamente en entornos residenciales y comerciales. También disponibles para puertas de madera.

Fluido 70, 110 and 150 are the new, compact sliding systems for tempered glass doors. They are suitable for wall, ceiling and false ceiling applications. In the false ceiling model the mechanism is completely concealed. Fluido+ systems feature a Colcom Progressive Closing

System (CPCS), combining a minimalist design with maximum functionality. It is quick and easy to install in residential and business premises. Version for timber doors also available.

Fluido 70, 110 und 150 ist das neue kompakte Schiebesystem für Türen aus vorgespanntem Glas. Geeignet für Anwendungen: Wänden, Decken, abgehängten Decken. In der Ausführung mit abgehängter Decke ist der Mechanismus komplett versteckt. Fluido+ integriert das neue Colcom Progressive Closing System (CPCS); in Kombination von minimalem Design und maximaler Funktionalität. Leichte und schnelle Montage in Wohn- und Geschäftsumgebungen. Auch für Holztüren verfügbar.

Fluido 70, 110 et 150 est le nouveau système coulissant compact pour portes en verre trempé. Il convient aux applications au mur, au plafond et faux plafond. Dans la version faux plafond, le mécanisme est complètement caché. Fluido + intègre le nouveau système de fermeture progressive Colcom (« Colcom Progressive Closing System » - CPCS) combinant un design minimaliste avec une fonctionnalité maximale. Il peut être installé facilement et rapidement dans des environnements résidentiels et commerciaux. Version pour portes en bois disponible.





FLUIDO+ 70 PORTE IN VETRO - GLASS DOORS

Soluzioni - Solutions

SCORREVOLE A SOFFITTO

Sliding on Ceiling

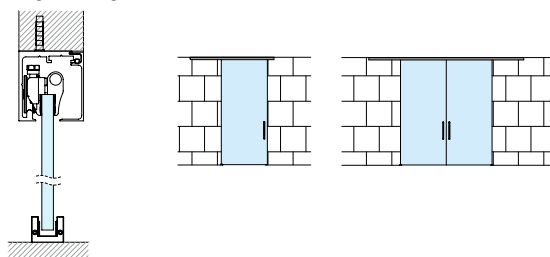

SCORREVOLE A PARETE

Sliding on Wall

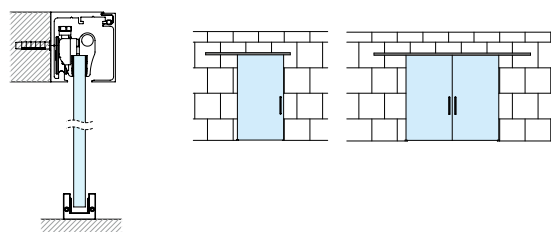

SCORREVOLE SU VETRO FISSO

Sliding on Sidelight

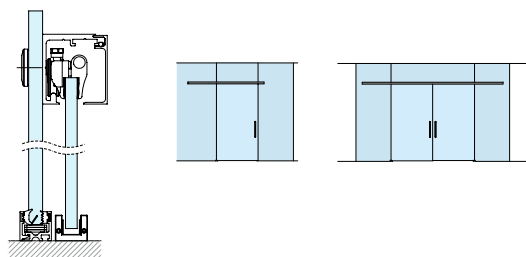

SCORREVOLE A SOFFITTO CON FISSO

Sliding on Ceiling with Sidelight

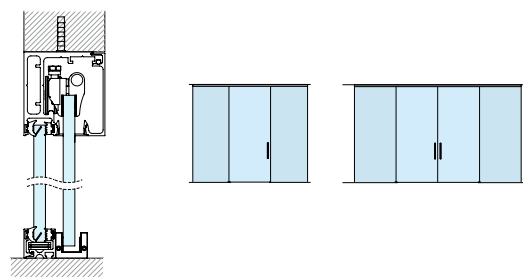

INSTALLAZIONE CON SUPPORTO A PARETE

Installation with Supports on Wall

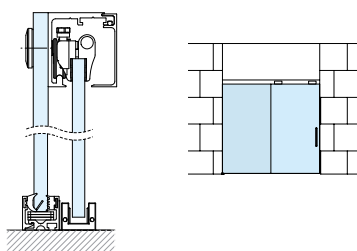

INSTALLAZIONE CON SUPPORTO A PARETE

Installation with Supports on Wall

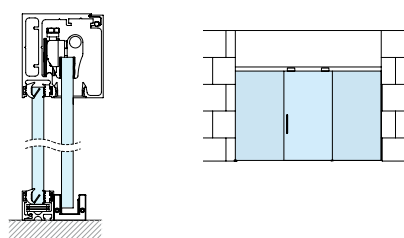

SCORREVOLE A FALSO SOFFITTO

Sliding on False Ceiling

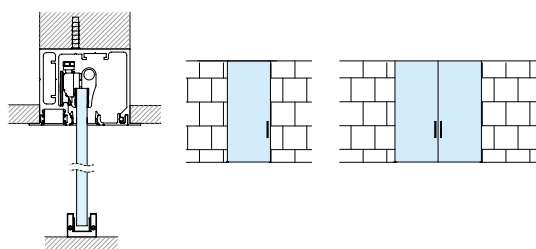

SCORREVOLE A FALSO SOFFITTO CON FISSO

Sliding on False Ceiling with Sidelight

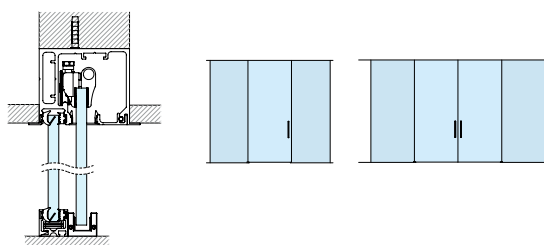

Caratteristiche Tecniche Profili - Profiles Technical Characteristics

SCORREVOLE A SOFFITTO

Sliding on Ceiling

60 x 55.5 mm

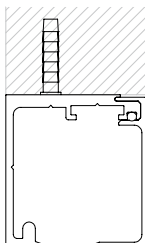

SCORREVOLE A PARETE

Sliding on Wall

60 x 55.5 mm

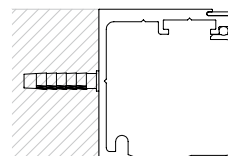

SCORREVOLE SU VETRO FISSO

Sliding on Sidelight

60 x 55.5 mm

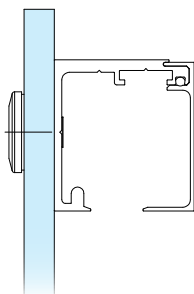

SCORREVOLE A SOFFITTO CON FISSO

Sliding on Ceiling with Sidelight

72 x 69.5 mm

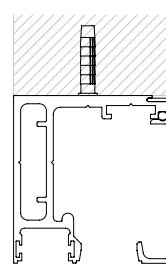

INSTALLAZIONE CON SUPPORTO A PARETE

Installation with Supports on Wall

60 x 55.5 mm

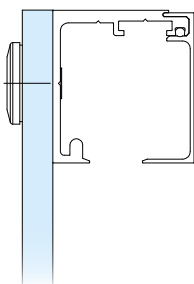

INSTALLAZIONE CON SUPPORTO A PARETE

Installation with Supports on Wall

72 x 69.5 mm

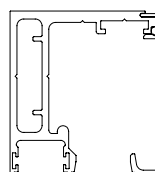

SCORREVOLE A FALSO SOFFITTO

Sliding on False Ceiling

85,4 x 72 mm

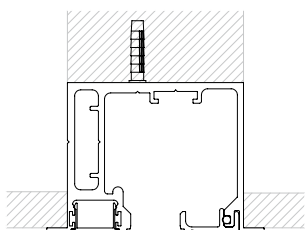

SCORREVOLE A FALSO SOFFITTO CON FISSO

Sliding on False Ceiling with Sidelight

85,4 x 72 mm

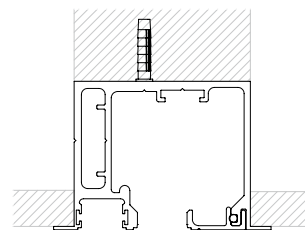

FLUIDO+ 70 PORTE IN LEGNO - WOODEN DOORS

Soluzioni - Solutions

SCORREVOLE A SOFFITTO - PORTA IN LEGNO

Sliding on Ceiling - Wooden Door

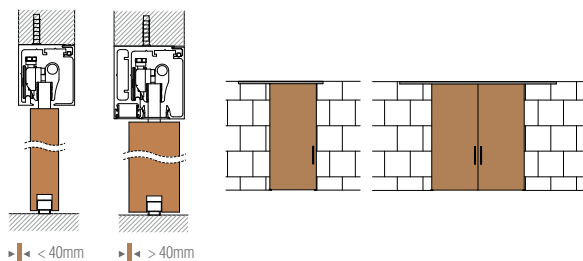

$< 40\text{mm}$ $> 40\text{mm}$

SCORREVOLE A PARETE - PORTA IN LEGNO

Sliding on Wall - Wooden Door

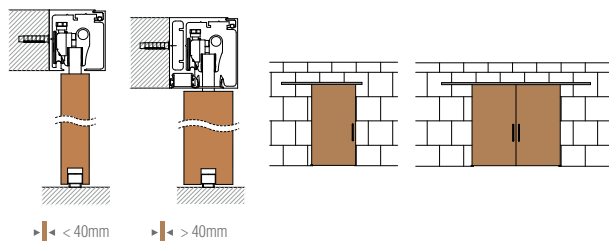

$< 40\text{mm}$ $> 40\text{mm}$

SCORREVOLE A SOFFITTO - PORTA IN LEGNO CON FISSO

Sliding on Ceiling - Wooden Door with Sidelight

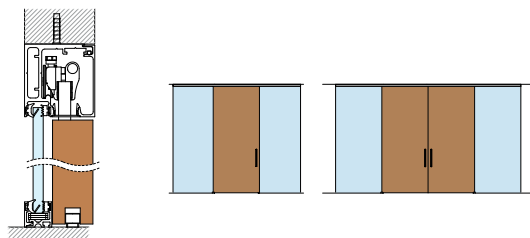

FLUIDO+ 70 PORTE IN LEGNO - WOODEN DOORS

Caratteristiche Tecniche Profili - Profiles Technical Characteristics

SCORREVOLE A SOFFITTO - PORTA IN LEGNO

Sliding on Ceiling - Wooden Door

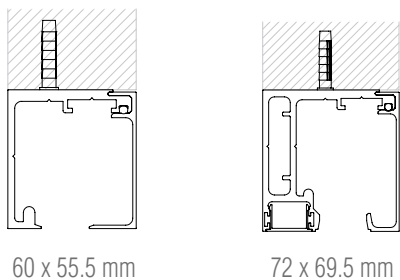

60 x 55.5 mm

72 x 69.5 mm

SCORREVOLE A PARETE - PORTA IN LEGNO

Sliding on Wall - Wooden Door

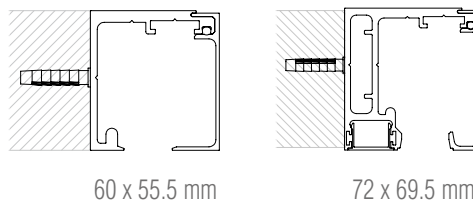

60 x 55.5 mm







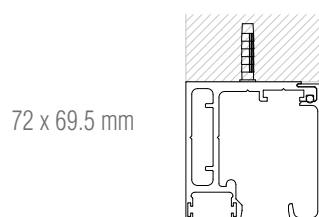







72 x 69.5 mm

SCORREVOLE A SOFFITTO - PORTA IN LEGNO CON FISSO

Sliding on Ceiling - Wooden Door with Sidelight



72 x 69.5 mm

 PORTATA Weight	70kg per porta / for door 154lbs		
 SPESSORE VETRO Glass thickness	8 ÷ 12 mm 5/16" to 1/2"		
 SPESSORE PORTA IN LEGNO Wooden door thickness	28 ÷ 50 mm 1 1/8" to 1 15/16"		
 REGOLAZIONE IN ALTEZZA Height adjustment	6 mm 1/4"		
 DISTANZA A PARETE Wall distance	19 mm 3/4"		
 DISTANZA TRA ANTA E VETRO FISSO Distance between door and sidelight	14.2 ÷ 16.2 mm 9/16" to 5/8"		
 INSTALLAZIONE A VETRO Glass installation	✓		
 INSTALLAZIONE A FALSO SOFFITTO False ceiling installation	✓		
 INSTALLAZIONE TRA PARETI Installation between walls	✓		
 SOFTCLOSE Soft close	Doppio / Double		
 DIMENSIONI MINIME (doppio Softclose) Minimum dimensions (double soft close)	660 mm 26"		
 RETAINER MECCANICO Mechanical retainer	Doppio / Double		
 DIMENSIONI MINIME (doppio Retainer) Minimum dimensions (double Retainer)	450 mm 17 11/16"		
 FINITURE Finishes	02 Ossidato naturale Natural oxidized	05 Ossidato nero Black oxidized	13 PVD simil inox similar PVD stainless steel



**CERTIFICAZIONE DURABILITÀ
CICLI CORROSIONE**
Durability certification
Corrosion cycles

DURABILITÀ (100.000 Cicli)
Durability (100.000 Cycles)

PESO DELLA PORTA (da 51 a 100 kg)
Door mass (from 51 up to 100 kg)

SICUREZZA (Grado 1 per tutti gli scorrevoli)
Safety (All sliding must be grade 1)

RESISTENZA ALLA CORROSIONE (Alta resistenza)
Corrosion resistance (High resistance)

CATEGORIA DELLA PORTA (Porta scorrevole)
Category of door (Sliding door)

FRIZIONE INIZIALE VALORE MASSIMO CONSENTITO (40N)
Initial friction maximum permitted value (40N)

according to
EN1527

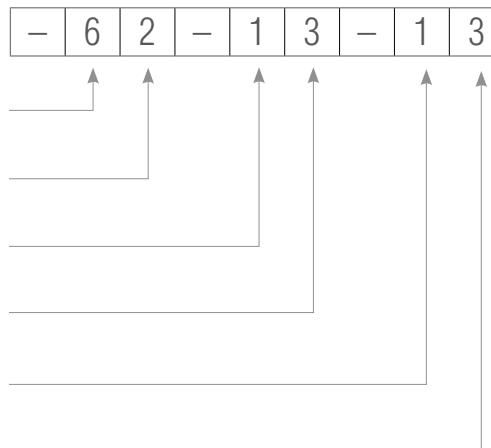

FLUIDO+ 70

scorrevole a soffitto
sliding on ceiling

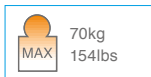
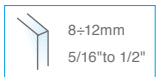

- Profili per scorrevole
- fissaggio a soffitto/parete.
- Perfil para sistema corredero
- fijación a techo/pared.
- Profiles for sliders
- fixed on ceiling/wall.
- Schiebeseystem Fluido
- Befestigung an der Decke/Wand.
- Profils pour coulissants
- fixation au plafond/mur.

LUNGHEZZE PROFILI - LENGTH OF PROFILES

B110EK00/2 (2 mt)

B110EK00/3 (3 mt)

B110EK00/4 (4 mt)

B110EK00/6 (6 mt)

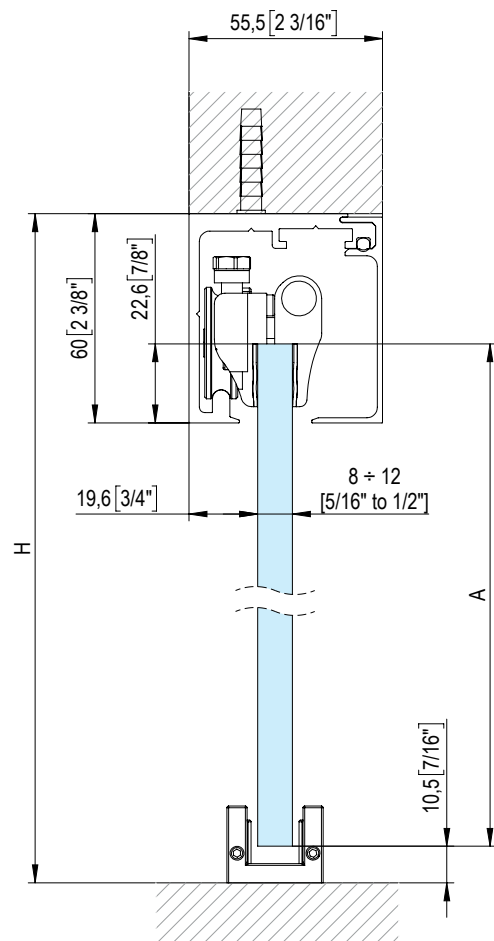
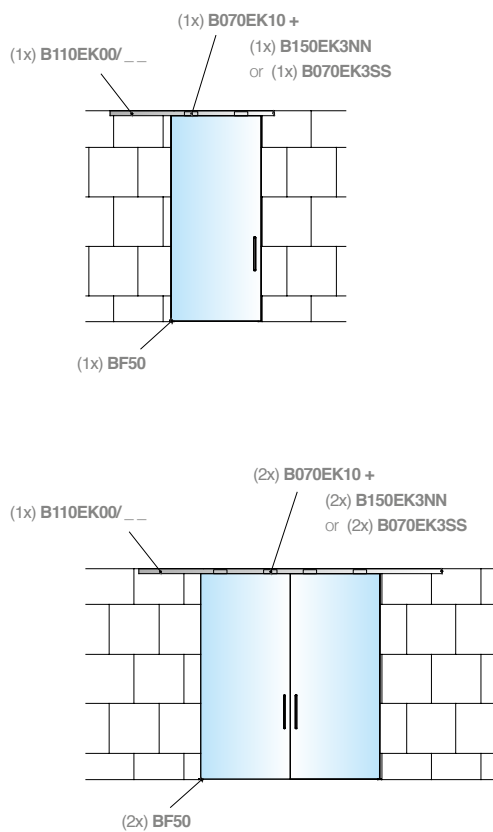
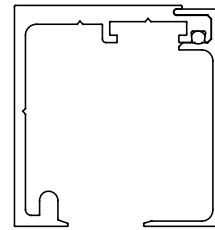

$$A = H - 48$$

$$[A = H - 1 \frac{7}{8}"]$$

L'installazione del Fluido 70, 110 e 150 non necessita di forature sul vetro. La instalación del "Fluido 70, 110 y 150" no necesita agujeros en el cristal. The installation of Fluido 70, 110 and 150 does not need holes on the glass. Die Systeme Fluido 70, 110 und 150 benötigen keine Glasbearbeitung. L'installation des coulissants Fluido 70, 110 et 150 ne requiert pas de perçage du verre.

FLUIDO+ 70

scorrevole a parete
sliding on wall

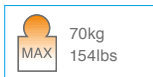
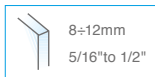

- Profili per scorrevole
- fissaggio a soffitto/parete.
- Perfil para sistema corredero
- fijación a techo/pared.
- Profiles for sliders
- fixed on ceiling/wall.
- Schiebeseystem Fluido
- Befestigung an der Decke/Wand.
- Profils pour coulissants
- fixation au plafond/mur.

LUNGHEZZE PROFILI - LENGTH OF PROFILES

B110EK00/2 (2 mt)

B110EK00/3 (3 mt)

B110EK00/4 (4 mt)

B110EK00/6 (6 mt)

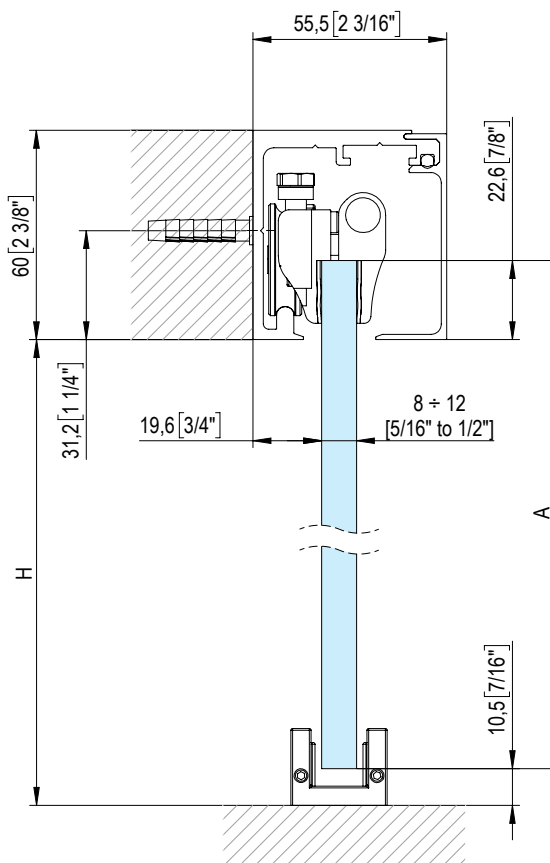
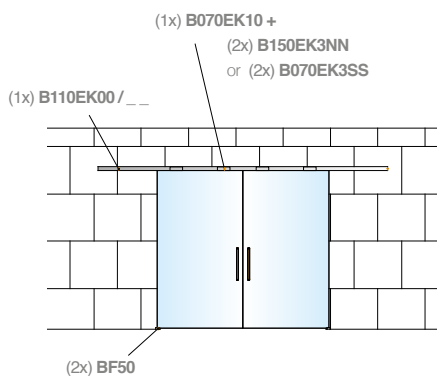
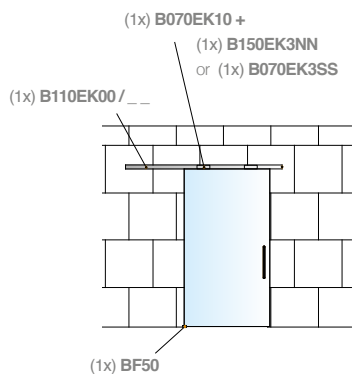
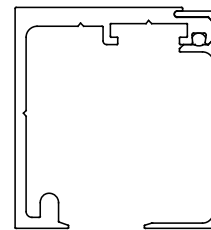

$$A = H + 12$$

$$[A = H + 1/2"]$$

L'installazione del Fluido 70, 110 e 150 non necessita di forature sul vetro. La instalación del "Fluido 70, 110 y 150" no necesita agujeros en el cristal. The installation of Fluido 70, 110 and 150 does not need holes on the glass. Die Systeme Fluido 70, 110 und 150 benötigen keine Glasbearbeitung. L'installation des coulissants Fluido 70, 110 et 150 ne requiert pas de perçage du verre.

FLUIDO+ 70

scorrevole su vetro fisso
sliding on sidelight

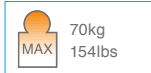
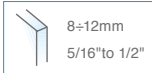

- Profili per scorrevole
- fissaggio a soffitto/parete.
- Perfil para sistema corredero
- fijación a techo/pared.
- Profiles for sliders
- fixed on ceiling/wall.
- Schiebeseystem Fluido
- Befestigung an der Decke/Wand.
- Profils pour coulissants
- fixation au plafond/mur.

LUNGHEZZE PROFILI - LENGTH OF PROFILES

B110EK00/2 (2 mt)

B110EK00/3 (3 mt)

B110EK00/4 (4 mt)

B110EK00/6 (6 mt)

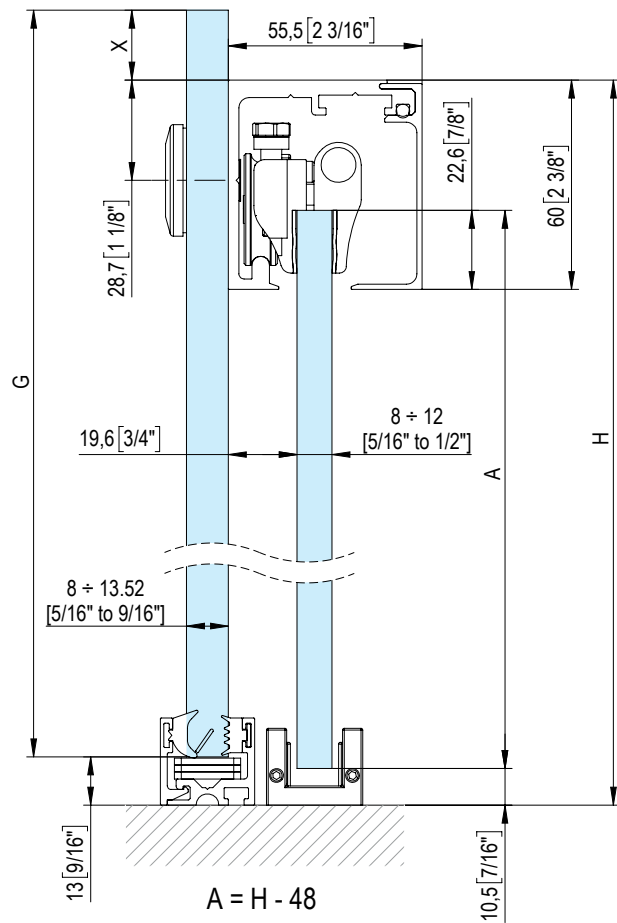
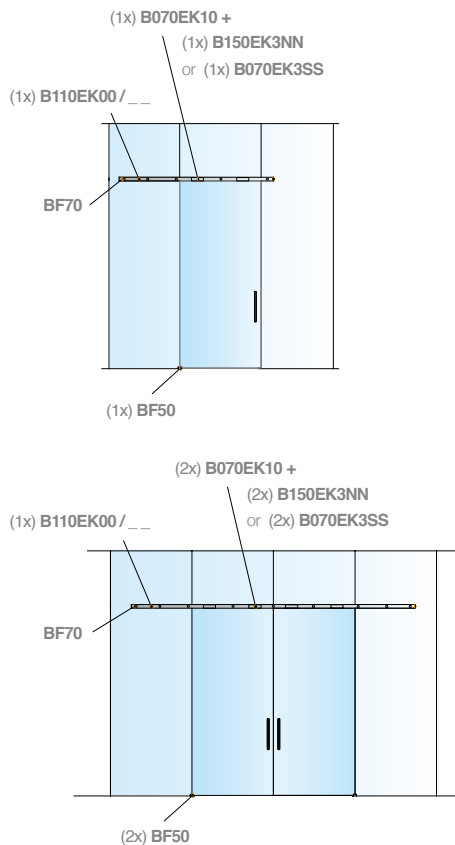
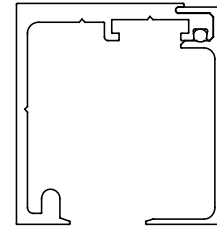

NON INCLUSI - NOT INCLUDED

P20EJ0810/6

P20EJ1113/6

P20E29/58



Vedere scheda catalogo P20E nella sezione PARTIZIONI
See P20E technical sheet in PARTITIONING section

$$A = H - 48$$

$$[A = H - 1 \frac{7}{8}"]$$

$$G = H + X - 13$$

$$[A = H + X - 1 \frac{1}{2}"]$$

L'installazione del Fluido 70, 110 e 150 non necessita di forature sul vetro. La instalación del "Fluido 70, 110 y 150" no necesita agujeros en el cristal. The installation of Fluido 70, 110 and 150 does not need holes on the glass. Die Systeme Fluido 70, 110 und 150 benötigen keine Glasbearbeitung. L'installation des coulissants Fluido 70, 110 et 150 ne requiert pas de perçage du verre.

FLUIDO+ 70

scorrevole a soffitto con fisso
sliding on ceiling with sidelight

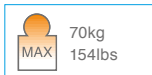
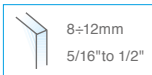

- Profili per scorrevole
- fissaggio a soffitto con vetro fisso.
- Perfil para sistema corredero
- fijación a techo con vidrio fijo.
- Profiles for sliders
- fixed on ceiling with fixed glass.
- Schiebeseystem Fluido
- Befestigung an Decke mit Seitenteilen aus Glas.
- Profils pour coulissant
- fixation au plafond avec verre fixe.

LUNGHEZZE PROFILI - LENGTH OF PROFILES

- B110EK01/2 (2 mt)
- B110EK01/3 (3 mt)
- B110EK01/4 (4 mt)
- B110EK01/6 (6 mt)

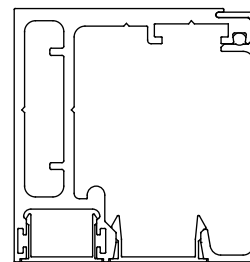

OPTIONAL

- | | |
|------------------|------------------|
| B150EP45/2 (2mt) | B150EP46/2 (2mt) |
| B150EP45/3 (3mt) | B150EP46/3 (3mt) |
| B150EP45/4 (4mt) | B150EP46/4 (4mt) |
| B150EP45/6 (6mt) | B150EP46/6 (6mt) |

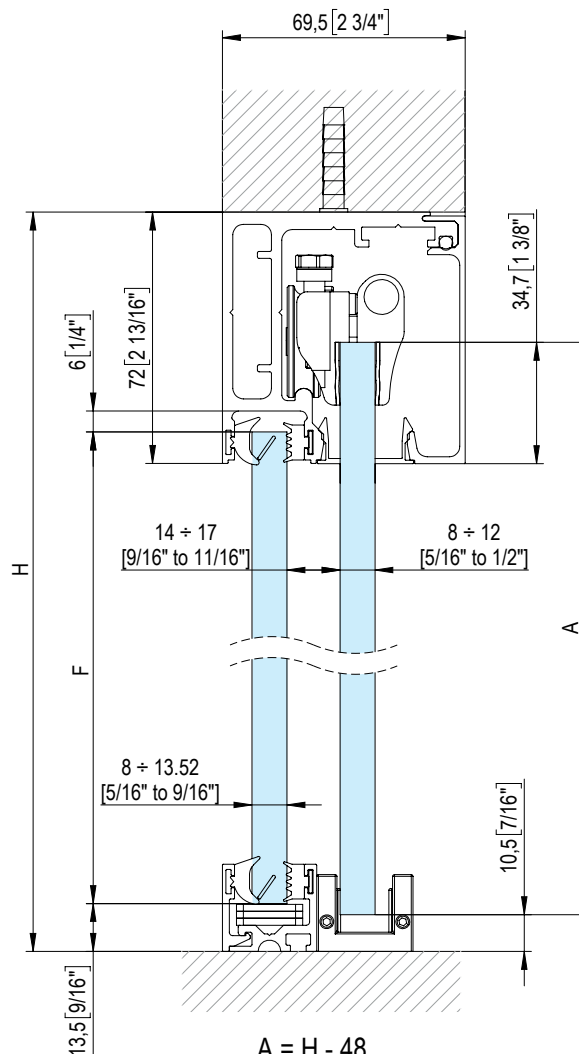
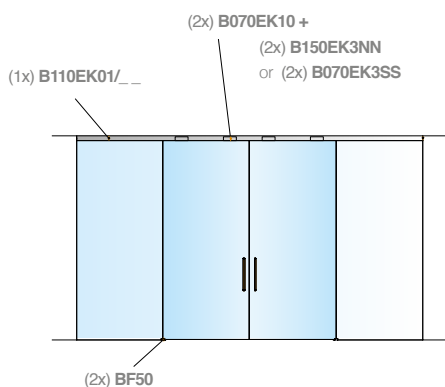
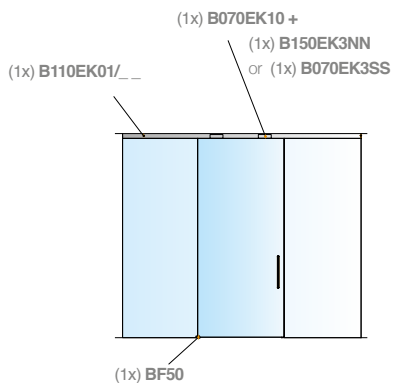

$$A = H - 48$$

$$[A = H - 1 7/8"]$$

NON INCLUSI - NOT INCLUDED

P20EJ0810/6



P20EJ1113/6



P20E29/58



Vedere scheda catalogo P20E nella sezione PARTIZIONI
See P20E technical sheet in PARTITIONING section

L'installazione dei Fluido 70, 110 e 150 non necessita di forature sul vetro. La instalación del "Fluido 70, 110 y 150" no necesita agujeros en el cristal. The installation of Fluido 70, 110 and 150 does not need holes on the glass. Die Systeme Fluido 70, 110 und 150 benötigen keine Glasbearbeitung. L'installation des coulissants Fluido 70, 110 et 150 ne requiert pas de perçage du verre.

FLUIDO+ 70

installazione con supporti a parete installation with supports on wall

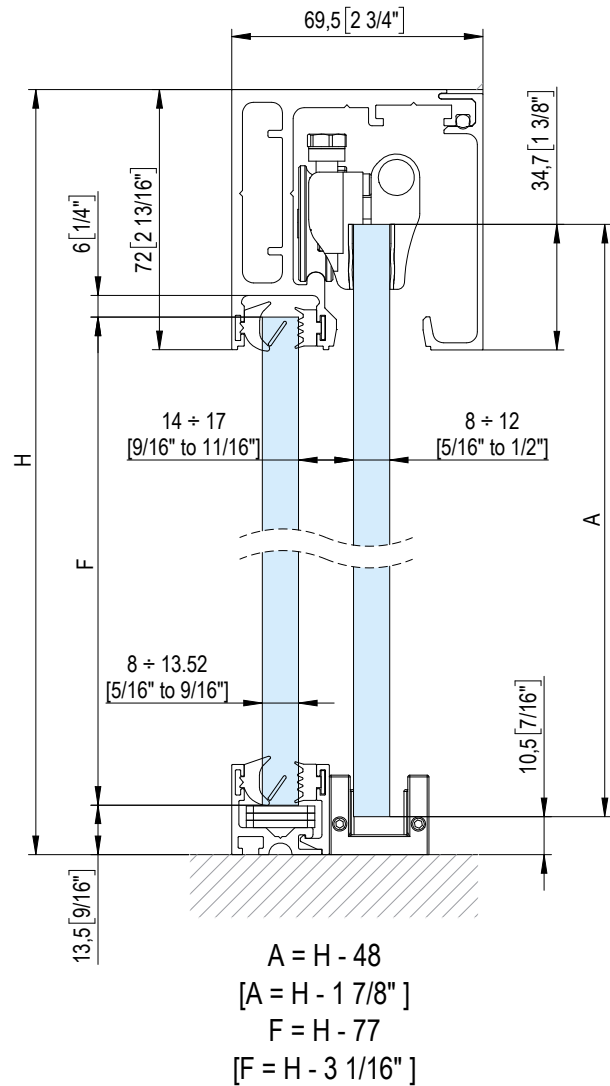
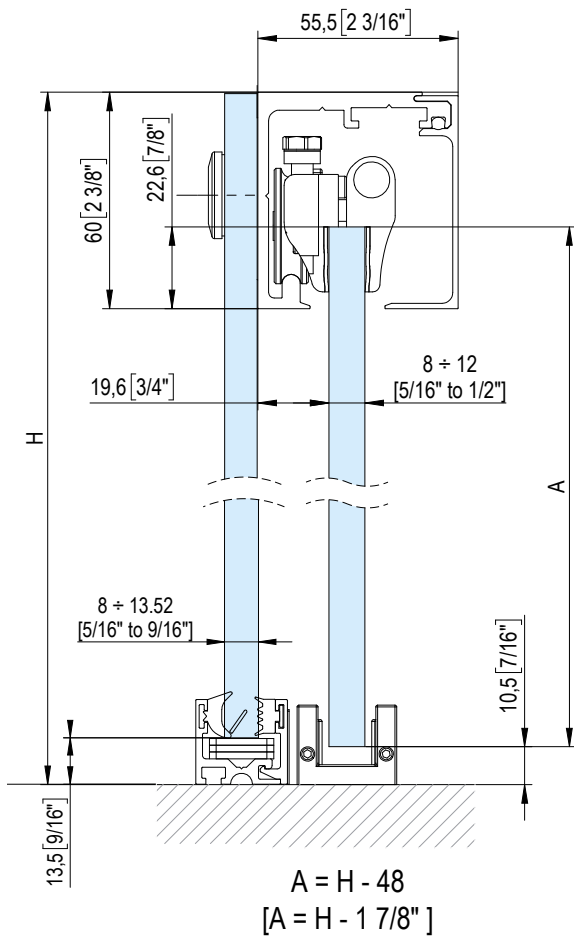
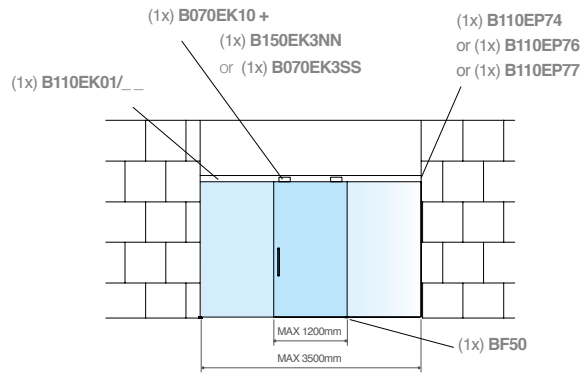
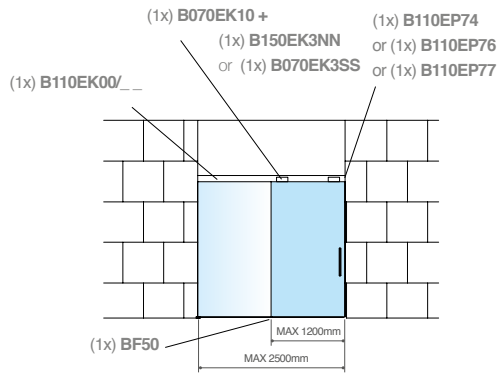
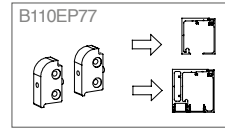
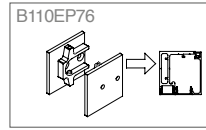
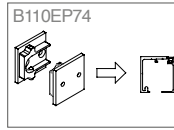
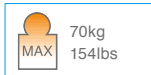
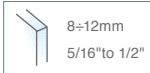

NON INCLUSI - NOT INCLUDED

P20EJ0810/6

P20EJ1113/6

P20E29/58



Vedere scheda catalogo P20E nella sezione PARTIZIONI
See P20E technical sheet in PARTITIONING section

L'installazione dei Fluido 70, 110 e 150 non necessita di forature sul vetro. La instalación del "Fluido 70, 110 y 150" no necesita hojas en el cristal. The installation of Fluido 70, 110 and 150 does not need holes on the glass. Die Systeme Fluido 70, 110 und 150 benötigen keine Glasbearbeitung. L'installation des coulissants Fluido 70, 110 et 150 ne requiert pas de perçage du verre.

FLUIDO+ 70

scorrevole a falso soffitto
sliding on false ceiling

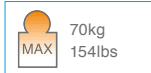
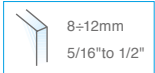

- Profili per scorrevole
- fissaggio a falso soffitto.
- Perfil para sistema corredero
- fijación a cielo falso.
- Profiles for sliders
- fixed on false ceiling.
- Profil für Schiebesystem
- Befestigung an abgehängter Decke.
- Profils pour portes coulissantes
- fixation sur faux-plafond.

! Disponibile da Marzo 2021
Available from March 2021

LUNGHEZZE PROFILI - LENGTH OF PROFILES

B110EK02/2 (2 mt)

B110EK02/3 (3 mt)

B110EK02/4 (4mt)

B110EK02/6 (6mt)

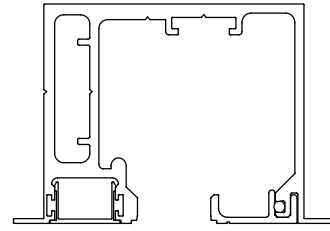

OPTIONAL

B150EP45/2 (2mt)

B150EP45/3 (3mt)

B150EP45/4 (4mt)

B150EP45/6 (6mt)

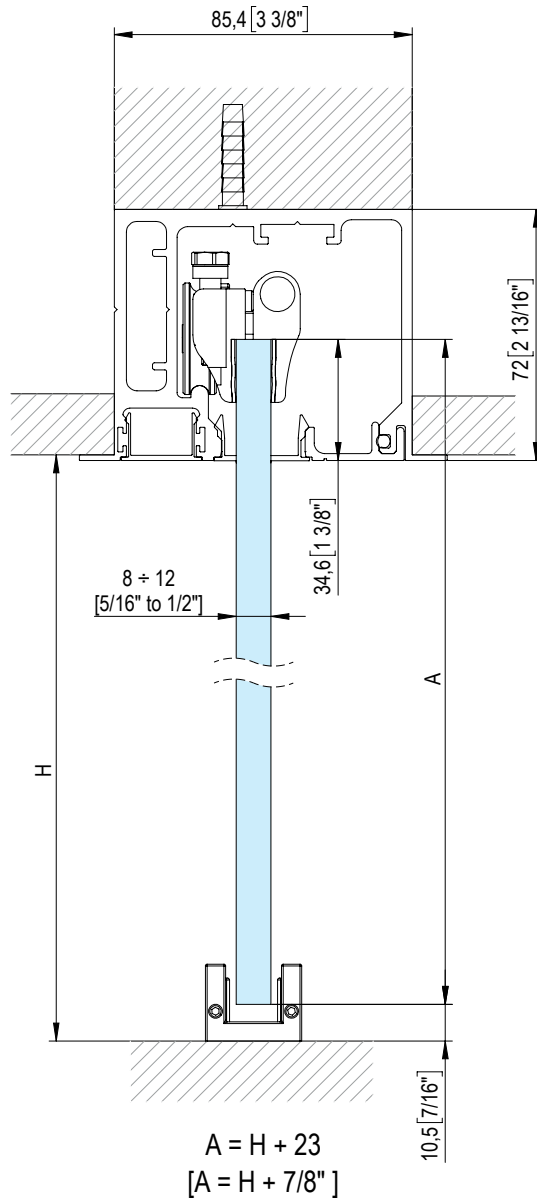
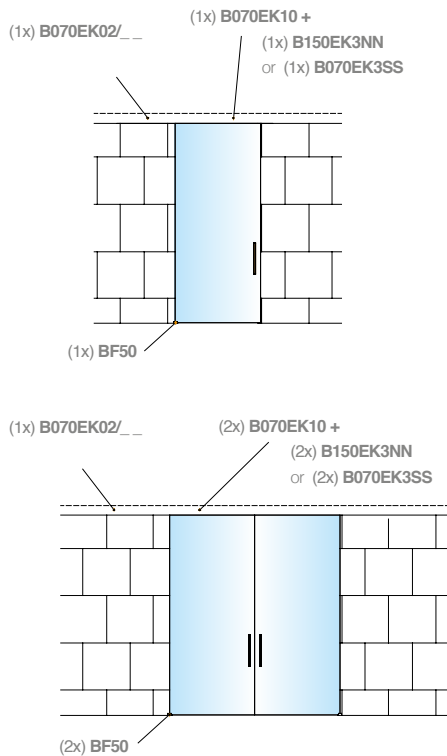

$$A = H + 23$$

$$[A = H + 7/8"]$$

L'installazione dei Fluido 70, 110 e 150 non necessita di forature sul vetro. La instalación del "Fluido 70, 110 y 150" no necesita agujeros en el cristal. The installation of Fluido 70, 110 and 150 does not need holes on the glass. Die Systeme Fluido 70, 110 und 150 benötigen keine Glasbearbeitung. L'installation des coulissants Fluido 70, 110 et 150 ne requiert pas de perçage du verre.

FLUIDO+ 70

scorrevole a falso soffitto con fisso
sliding on false ceiling with sidelight

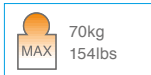
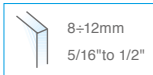

- Profili per scorrevole
- fissaggio a falso soffitto con vetro fisso.
- Perfil para sistema corredero
- fijación a cielo falso con vidrio fijo.
- Profiles for sliders - fixed on false ceiling with fixed glass.
- Profil für Schiebesystem – Befestigung an abgehängter Decke mit Glasseiten-
teil.
- Profils pour coulissants - fixation faux-plafond avec verre fixe.

! Disponibile da Marzo 2021
Available from March 2021

LUNGHEZZE PROFILI - LENGTH OF PROFILES

- B110EK02/2 (2 mt)
- B110EK02/3 (3 mt)
- B110EK02/4 (4 mt)
- B110EK02/6 (6 mt)

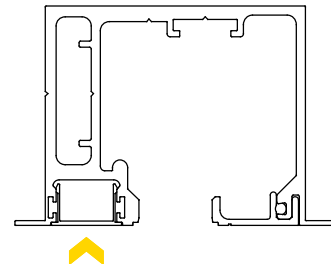

OPTIONAL

- B150EP45/2 (2mt)
- B150EP45/3 (3mt)
- B150EP45/4 (4mt)
- B150EP45/6 (6mt)

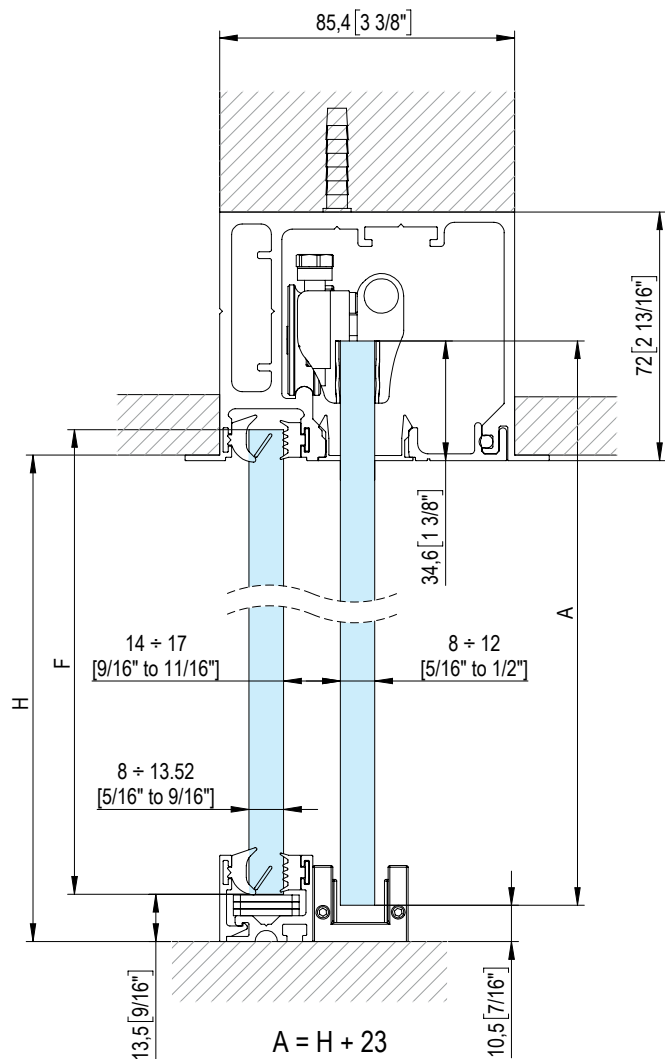
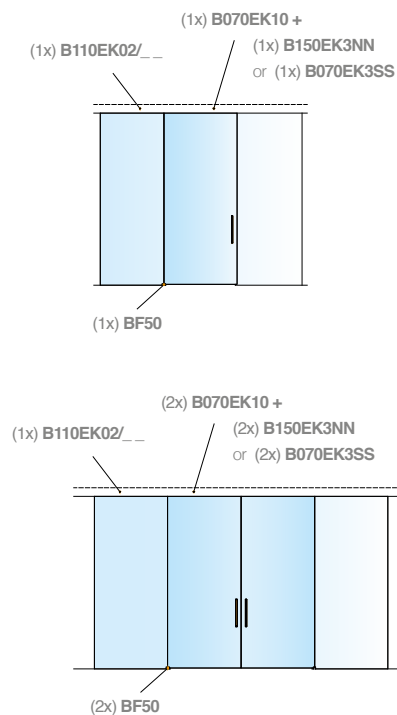

NON INCLUSI - NOT INCLUDED

P20EJ0810/6 P20EJ1113/6 P20E29/58



Vedere scheda catalogo P20E nella sezione PARTIZIONI
See P20E technical sheet in PARTITIONING section

$$A = H + 23$$

$$[A = H + 7/8"]$$

$$F = H - 6$$

$$[F = H - 1/4"]$$

L'installazione dei Fluido 70, 110 e 150 non necessita di forature sul vetro. La instalación del "Fluido 70, 110 y 150" no necesita agujeros en el cristal. The installation of Fluido 70, 110 and 150 does not need holes on the glass. Die Systeme Fluido 70, 110 und 150 benötigen keine Glasbearbeitung. L'installation des coulissants Fluido 70, 110 et 150 ne requiert pas de perçage du verre.

FLUIDO+ 70



scorrevole a soffitto - porta in legno
sliding on ceiling - wooden door

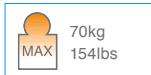

- Profili per scorrevole in legno
- fissaggio a soffitto.
- Perfil para sistema corredero - puertas de madera
- fijación a techo.
- Profiles for sliders - wooden doors
- fixed on ceiling.
- Schiebeseystem Fluido - Holztüren
- Befestigung an der Decke.
- Profils pour coulissants - Portes en bois
- fixation au plafond.

LUNGHEZZE PROFILI - LENGTH OF PROFILES

B110EK00/2 (2 mt)

B110EK00/3 (3 mt)

B110EK00/4 (4mt)

B110EK00/6 (6mt)

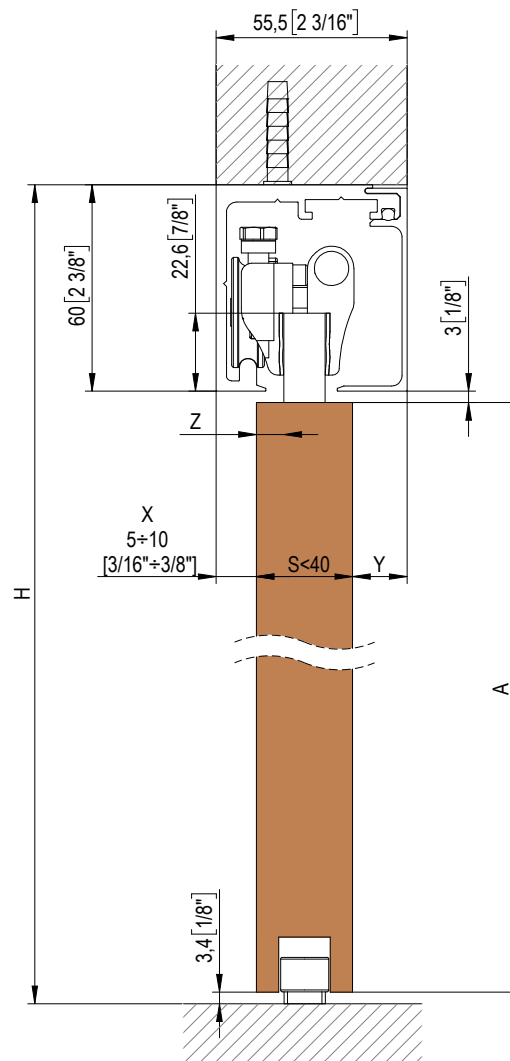
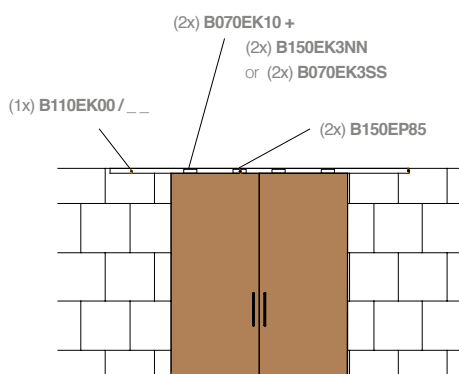
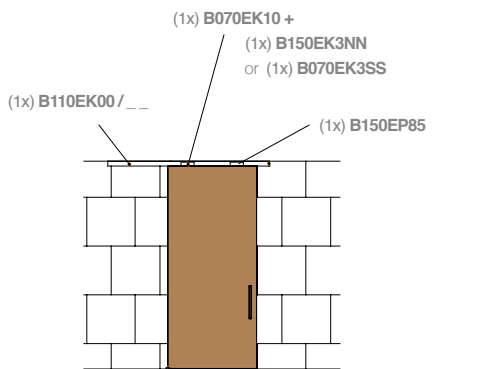
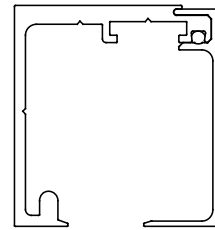

$$\begin{aligned}
 A &= H - 66 \\
 [A &= H - 2 \text{ 5/8"}] \\
 Y &= 55.5 - X - S \\
 [Y &= [2 \text{ 3/16"} - X - S] \\
 Z &= 20 - X \\
 [Z &= 13/16" - X]
 \end{aligned}$$

FLUIDO+ 70

 > 40 mm

scorrevole a soffitto - porta in legno
sliding on ceiling - wooden door

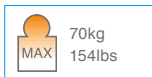

- Profili per scorrevole in legno
- fissaggio a soffitto.
- Perfil para sistema corredero - puertas de madera
- fijación a techo.
- Profiles for sliders - wooden doors
- fixed on ceiling.
- Schiebeseystem Fluido - Holztüren
- Befestigung an der Decke.
- Profils pour coulissants - Portes en bois
- fixation au plafond.

LUNGHEZZE PROFILI - LENGTH OF PROFILES

- B110EK01/2** (2 mt)
- B110EK01/3** (3 mt)
- B110EK01/4** (4 mt)
- B110EK01/6** (6 mt)

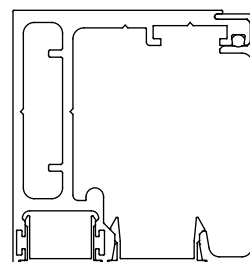

OPTIONAL

- | | |
|------------------|------------------|
| B150EP45/2 (2mt) | B150EP46/2 (2mt) |
| B150EP45/3 (3mt) | B150EP46/3 (3mt) |
| B150EP45/4 (4mt) | B150EP46/4 (4mt) |
| B15EP45/6 (6mt) | B150EP46/6 (6mt) |

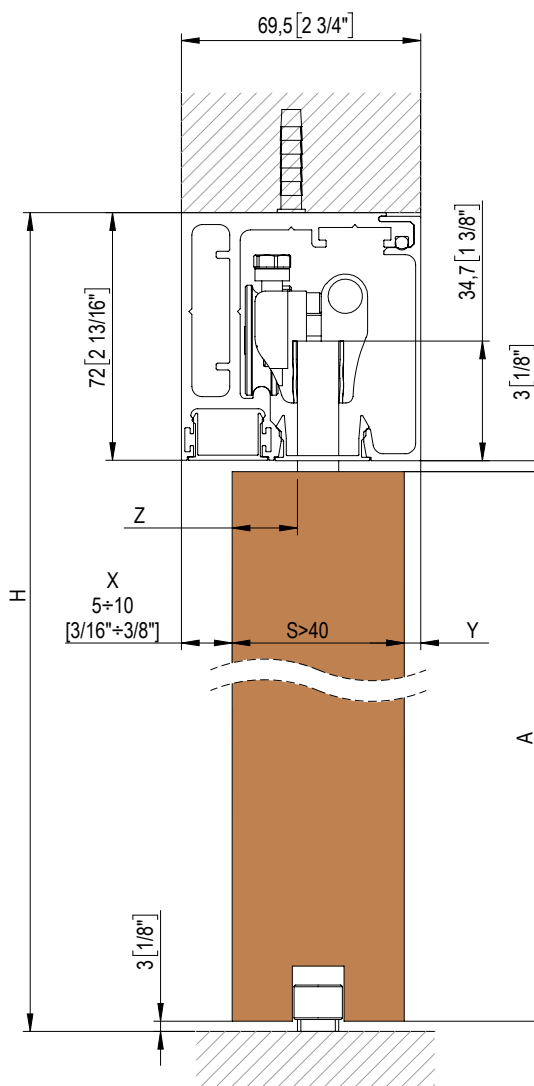
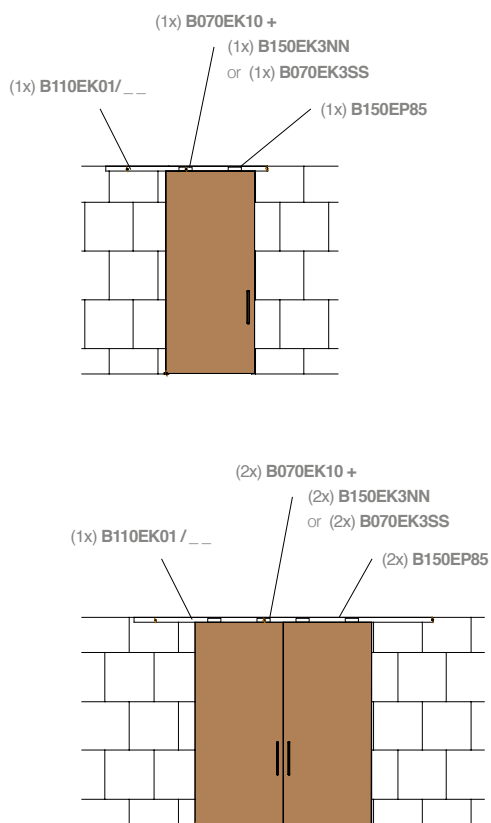

$$\begin{aligned}
 A &= H - 78 \\
 [A &= H - 3 \frac{1}{16}"] \\
 Y &= 69.5 - X - S \\
 [Y &= [2 \frac{3}{4} - X - S] \\
 Z &= 34 - X \\
 [Z &= 1 \frac{5}{16} - X]
 \end{aligned}$$

FLUIDO+ 70



scorrevole a parete - porta in legno
sliding on wall - wooden door

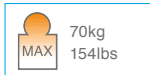

- Profili per scorrevole in legno
- fissaggio a parete.
- Perfil para sistema corredero - puertas de madera
- fijación a pared.
- Profiles for sliders - wooden doors
- fixed on wall.
- Schiebeseystem Fluido - Holztüren
- Befestigung an der Wand.
- Profils pour coulissants - Portes en bois
- fixation au mur.

LUNGHEZZE PROFILI - LENGTH OF PROFILES

B110EK00/2 (2 mt)

B110EK00/3 (3 mt)

B110EK00/4 (4mt)

B110EK00/6 (6mt)

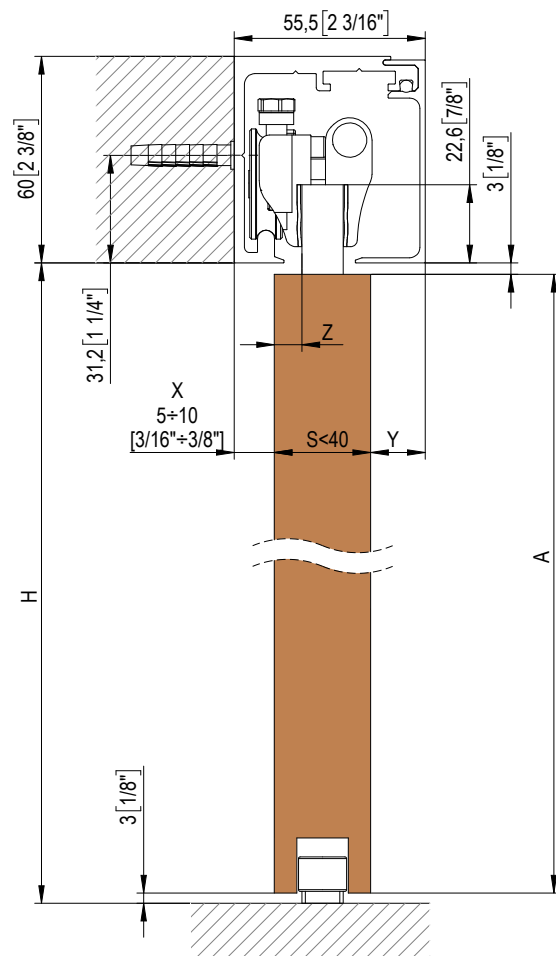
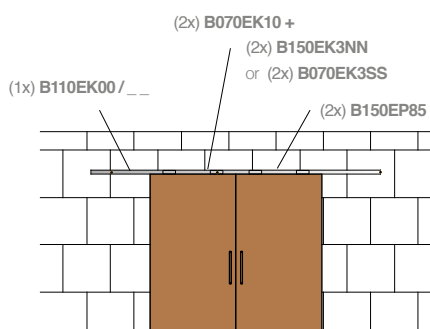
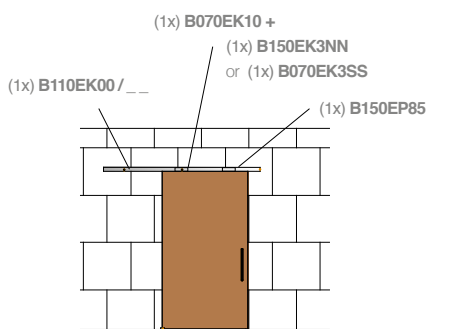
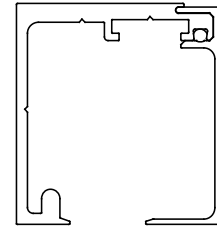

$$\begin{aligned}
 A &= H - 6 \\
 [A &= H - 1/4"] \\
 Y &= 55.5 - X - S \\
 [Y &= [2 \ 3/16" - X - S] \\
 Z &= 20 - X \\
 [Z &= 13/16" - X]
 \end{aligned}$$

FLUIDO+ 70



scorrevole a parete - porta in legno
sliding on wall - wooden door

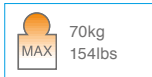

- Profili per scorrevole in legno
- fissaggio a parete.
- Perfil para sistema corredero - puertas de madera
- fijación a pared.
- Profiles for sliders - wooden doors
- fixed on wall.
- Schiebesystem Fluido - Holztüren
- Befestigung an der Wand.
- Profils pour coulissants - Portes en bois
- fixation au mur.

LUNGHEZZE PROFILI - LENGTH OF PROFILES

- B110EK01/2** (2 mt)
- B110EK01/3** (3 mt)
- B110EK01/4** (4 mt)
- B110EK01/6** (6 mt)

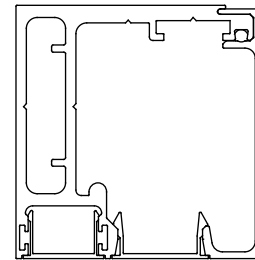

OPTIONAL

- | | |
|------------------|------------------|
| B150EP45/2 (2mt) | B150EP46/2 (2mt) |
| B150EP45/3 (3mt) | B150EP46/3 (3mt) |
| B150EP45/4 (4mt) | B150EP46/4 (4mt) |
| B150EP45/6 (6mt) | B150EP46/6 (6mt) |

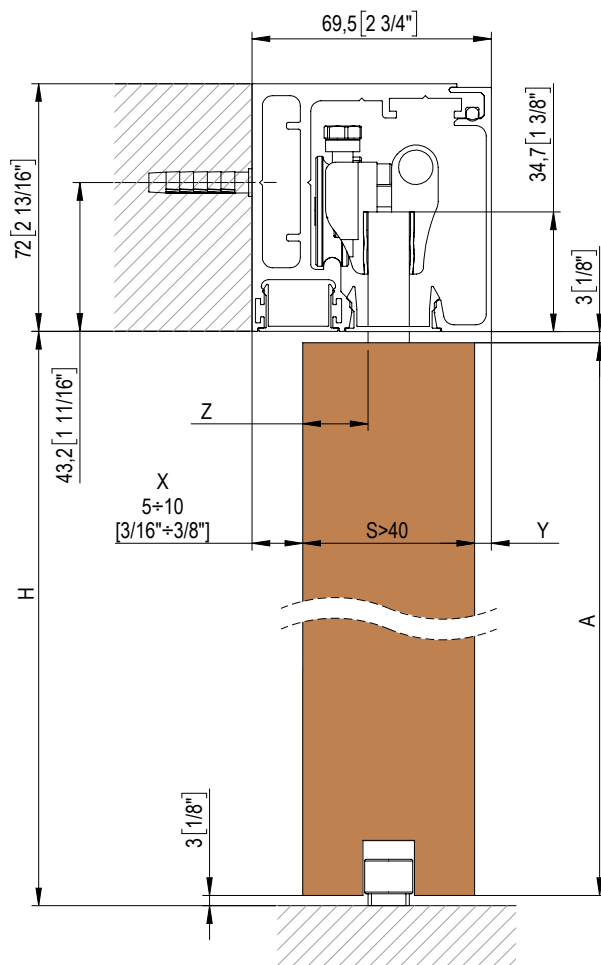
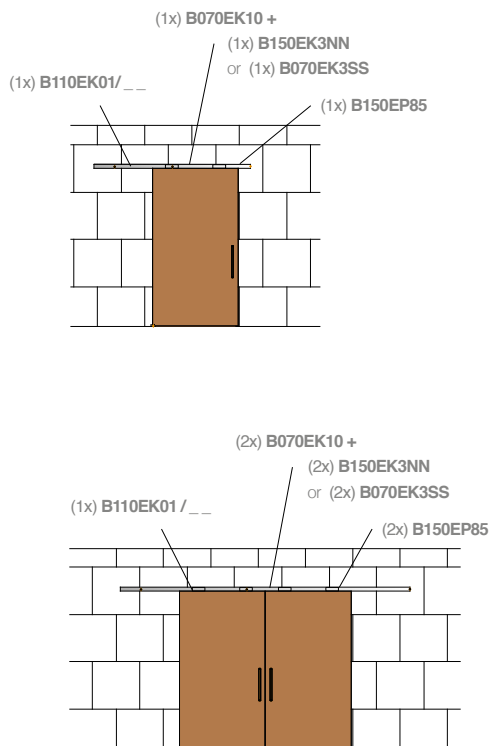

$$\begin{aligned}
 A &= H - 6 \\
 [A &= H - 1/4"] \\
 Y &= 69.5 - X - S \\
 [Y &= [2 3/4" - X - S] \\
 Z &= 34 - X \\
 [Z &= 1 5/16" - X]
 \end{aligned}$$

FLUIDO+ 70

scorrevole a soffitto - porta in legno con fisso
sliding on ceiling - wooden door with sidelight

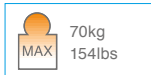

- Profili per scorrevole in legno
- fissaggio a soffitto con vetro fisso.
- Perfil para sistema corredero - puertas de madera
- fijación a techo con vidrio fijo.
- Profiles for sliders - wooden doors
- fixed on ceiling with fixed glass.
- Schiebeseystem Fluido - Holztüren
- Befestigung an Decke mit Seitenteilen aus Glas.
- Profils pour coulissant - Portes en bois
- fixation au plafond avec verre fixe.

LUNGHEZZE PROFILI - LENGTH OF PROFILES

- B110EK01/2 (2 mt)
- B11EK01/3 (3 mt)
- B110EK01/4 (4 mt)
- B110EK01/6 (6 mt)

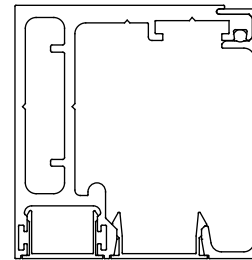

OPTIONAL

- | | |
|------------------|------------------|
| B150EP45/2 (2mt) | B150EP46/2 (2mt) |
| B150EP45/3 (3mt) | B150EP46/3 (3mt) |
| B150EP45/4 (4mt) | B150EP46/4 (4mt) |
| B150EP45/6 (6mt) | B150EP46/6 (6mt) |

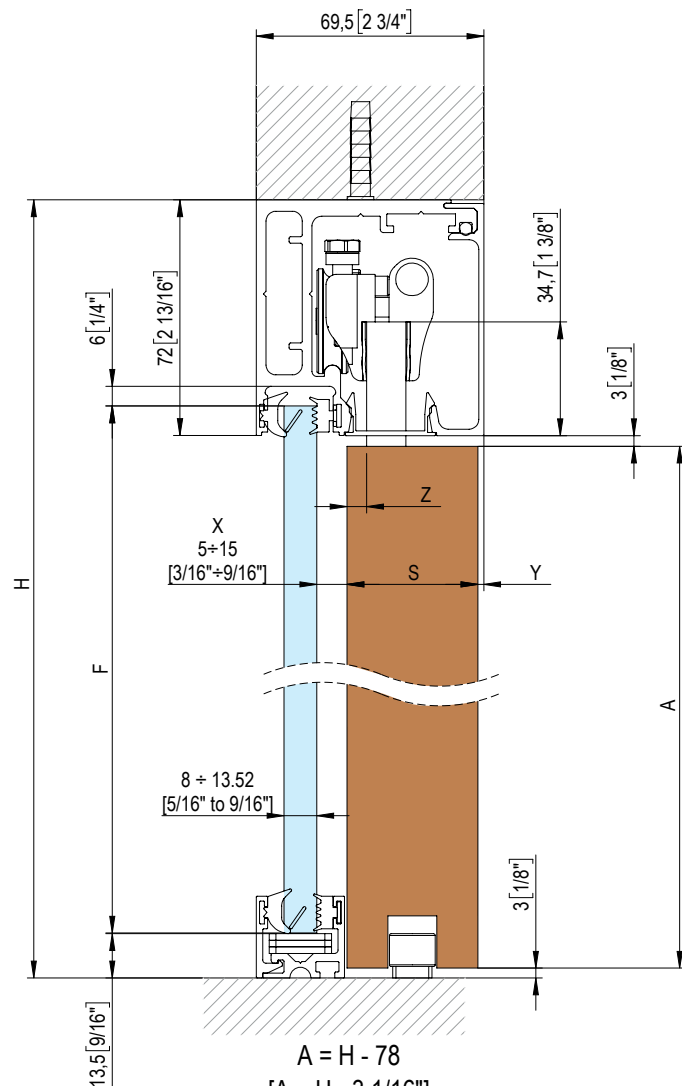
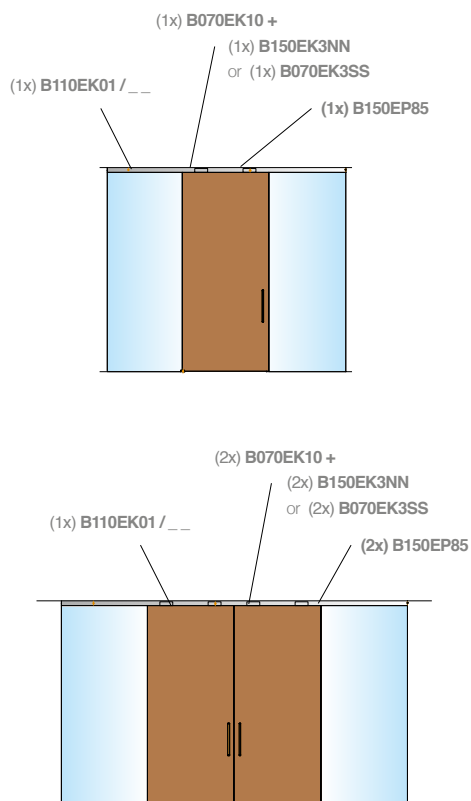

$$\begin{aligned}
 A &= H - 78 \\
 [A &= H - 3 \frac{1}{16}"] \\
 F &= H - 77 \\
 [F &= H - 3 \frac{1}{16}"] \\
 Y &= 69.5 - X - S \\
 [Y &= [2 \frac{3}{4} - X - S] \\
 Z &= 15 - X \\
 [Z &= 9/16 - X]
 \end{aligned}$$

FLUIDO+ 70-KIT

Components

KB070CS0/2

KB070CS0/3

- Kit scorrevole parete/soffitto con doppio soft-close.
- Kit corredizo de pared / techo con doble Soft-close
- Sliding wall / ceiling kit with double soft-close
- Schiebewand- / Deckensatz mit doppeltem Soft-Close
- Kit mur / plafond coulissant à double Soft-Close.

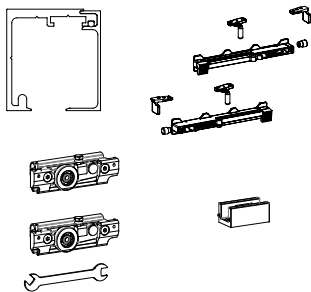

KB070SS0/2

KB070SS0/3

- Kit scorrevole su vetro fisso con doppio soft-close.
- Kit corredizo sobre vidrio fijo con doble Soft-close
- Sliding kit on fixed glass with double soft-close
- Schiebesatz auf festem Glas mit doppeltem Soft-Close
- Kit coulissant sur verre fixe avec double Soft-Close

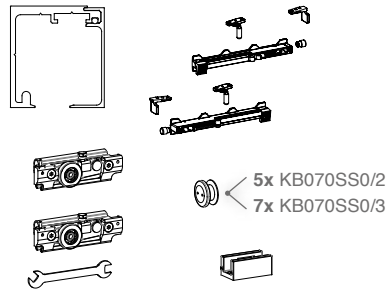

KB070FS0/2

KB070FS0/3

- Kit scorrevole a soffitto con fisso, con doppio soft-close.
- Kit de techo corredizo fijo con doble Soft-close
- Fixed sliding ceiling kit with double soft-close
- Festes Schiebedeckenset mit doppeltem Soft-Close
- Kit plafond fixe coulissant avec à double Soft-Close

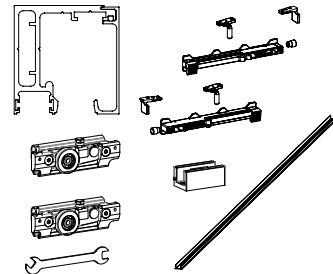

KB070CM0/2

KB070CM0/3

- Kit scorrevole parete/soffitto con retainer e stop meccanico.
- Kit corredizo de techo / pared con retenedor tope mecánico
- Sliding wall / ceiling kit with retainer and mechanical stop
- Schiebewand- / Deckensatz mit Halterung und mechanischem Anschlag
- Kit mur / plafond coulissant avec arrêtoir et butée mécanique

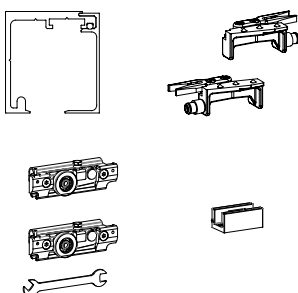

KB070SM0/2

KB070SM0/3

- Kit scorrevole su vetro fisso con retainer e stop meccanico.
- Kit corredizo sobre vidrio fijo con retenedor y tope mecánico
- Sliding kit on fixed glass with retainer and mechanical stop
- Schiebesatz auf festem Glas mit Halter und mechanischem Anschlag
- Kit coulissant sur verre fixe avec arrêtoir et butée mécanique

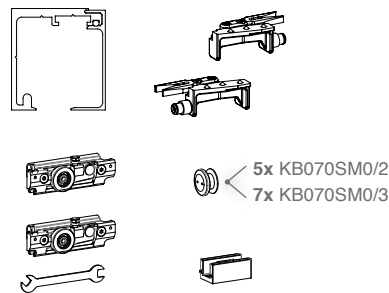

KB070FM0/2

KB070FM0/3

- Kit scorrevole a soffitto con fisso, con retainer e stop meccanico.
- Kit de techo corredizo fijo, con retenedor y tope mecánico.
- Sliding ceiling kit with fixed, with retainer and mechanical stop
- Schiebedeckensatz mit fester, mit Halterung und mechanischem Anschlag
- Kit plafond coulissant avec fixe, avec arrêtoir et butée mécanique

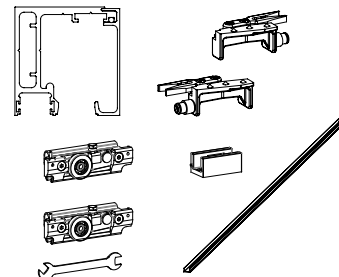

FLUIDO+ 70 - KIT PINZE

Clamps kit

B070EK10

Min.450mm
Min. 17 11/16"

- Kit coppia pinze con chiave
- Kit par de pinzas con llave
- Kit with pair of clamps with key
- Bausatz ein Paar Zangen mit Schlüssel
- Kit paire de pinces avec clé

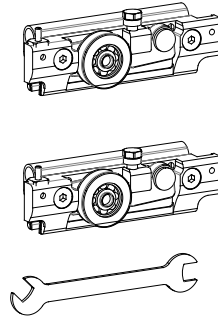

B150EK3NN

Min.450mm
Min. 17 11/16"

- Kit coppia Retainer. Stop meccanico
- Kit par tope mecánico
- Kit with pair of mechanical stops
- Bausatz ein Paar mechanische Stopper
- Kit paire arrêt mécanique

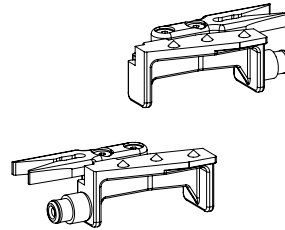

B070EK3SS

Min.650mm
Min. 25 9/16"

- Kit coppia Soft Close CPCS
- Kit par Soft Close CPCS
- Kit with Soft Close CPCS pair
- Bausatz ein Paar Soft Close CPCS
- Kit paire Soft Close CPCS

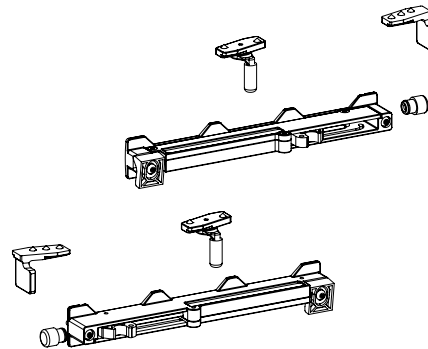

B110EP73

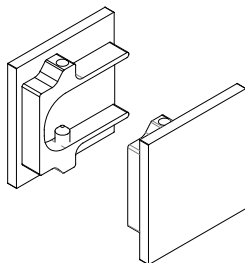

- Coppia di tappi.
- Par de tapones
- Pair of caps
- Paar Kappen
- Paire de bouchons

B110EP74

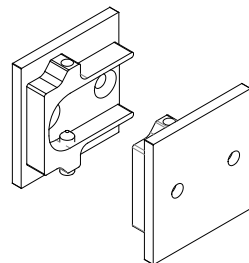

- Coppia di tappi forati.
- Par de tapones perforados
- Pair of perforated caps
- Paar Lochkappen
- Paire de bouchons perforés

B110EP75

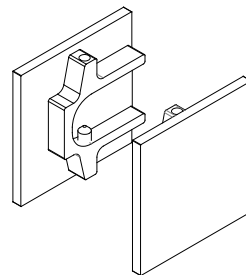

- Coppia di tappi per versione con fisso laterale.
- Par de tapones para versión con cristal fijo lateral
- Pair of caps for model with side fixed glass
- Paar Kappen für Version mit festem Seitenglas
- Paire de bouchons pour version avec vitrage fixe latéral

B110EP76

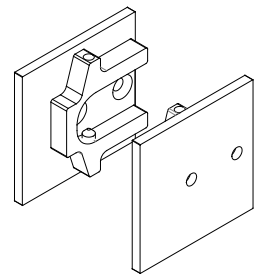

- Coppia di tappi forati per versione con fisso laterale.
- Par de tapones perforados para versión con cristal fijo lateral
- Pair of perforated caps for model with side fixed glass
- Paar Lochkappen für Version mit festem Seitenglas
- Paire de bouchons perforés pour version avec vitrage fixe latéral

FLUIDO+ 70 - COMPONENTI

Components

B110EP64

- Spessore per Veletta - Consigliato per binari oltre i 2,5m
- Cuña para panel - Aconsejado para perfiles de largo superior a 2,5 m
- Spacer for casing - Recommended for rails longer than 2,5 m
- Distanzstück für Anlauf - Empfohlen für Profilen über 2,5 m
- Épaisseur pour panneau - Recommandé pour les profils de plus de 2,5 m

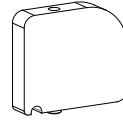

B110EP77

- Coppia supporti laterali
- Par de soportes laterales
- Pair of side fittings
- Paar Seitenträger
- Paire de supports latéraux

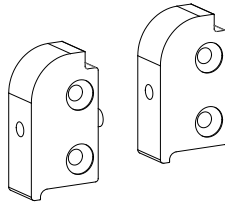

B150EP48

- Tassello di collegamento - per vetro fisso
- Pieza de unión - para cristal fijo
- Connection insert - for fixed glass
- Verbindungsdübel - für festem Glas
- Tasseau d'assemblage - pour vitrage fixe

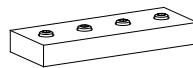

BF50

- Guida a terra.
- Guía de suelo
- Ground slide
- Bodenführung
- Guide au sol

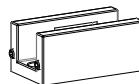

B150EP85

- Kit accessorio per porte in legno.
- Kit accesorios para puertas de madera.
- Accessory kit for wooden doors.
- Zubehörkit für Holztüren.
- Kit accessoires pour portes en bois.

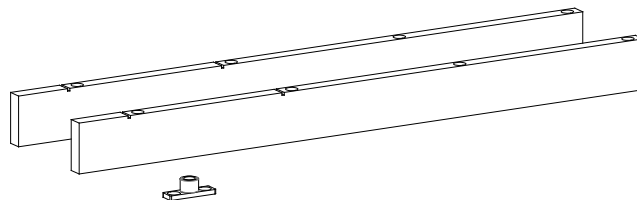

BF70

- Borchia per fissaggio barra a vetro.
- Perno de fijación de la barra al cristal
- Boss for securing glass bar
- Senkschraube zur Befestigung der Stange am Glas
- Clou de fixation de la barre à la vitre

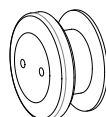

Lunghezza barra	Quantità borchie
Longitud de la barra Bar length Profillänge Longueur de barre	Cantidad tornillos Quantity of studs Anzahl der Stifte Quantité
2 mt	5
3,2 mt	8
4 mt	10
6 mt	15

B150EP27

- Perno per porte battenti da applicare ad estrusi Fluido+.
- Pernio para puertas batientes, por aplicar a perfiles Fluido+.
- Spindle for swing doors, to be applied to Fluido+ profiles.
- Drehpunkt für Pendeltüren für Fluido+ Profilen.
- Pivot pour portes battantes à appliquer sur profils Fluido+.

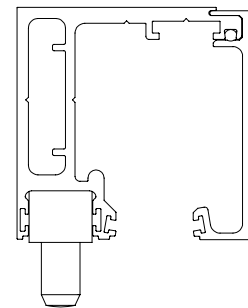
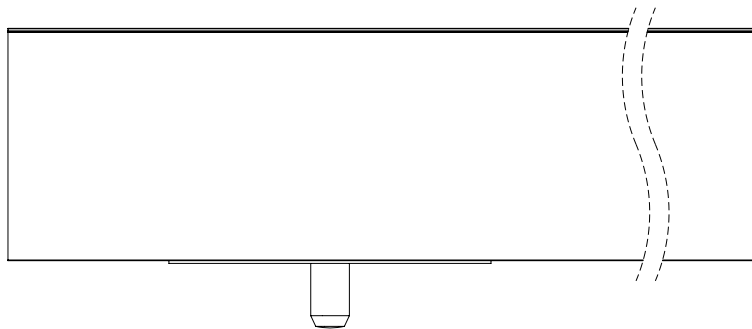
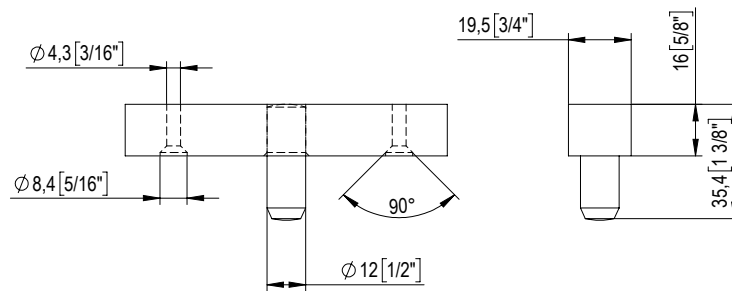
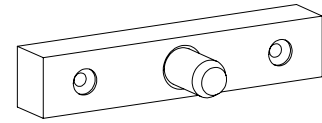
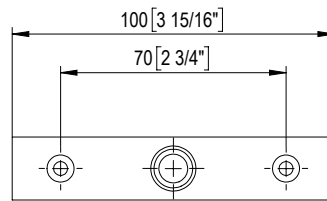

ESEMPIO APPLICAZIONE CON CERNIERA UNICA 101E10 - 100E20

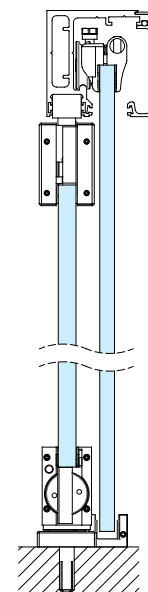
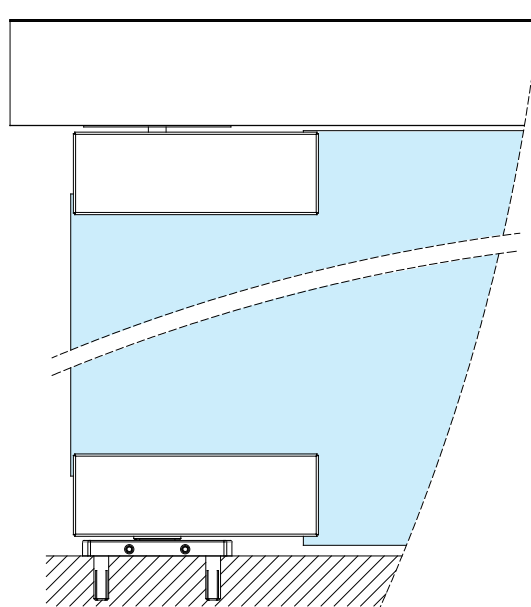
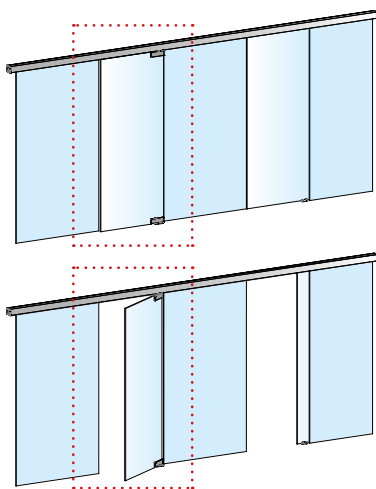

FLUIDO+ 110 PORTE IN VETRO - GLASS DOORS

Soluzioni - Solutions

SCORREVOLE A SOFFITTO

Sliding on Ceiling

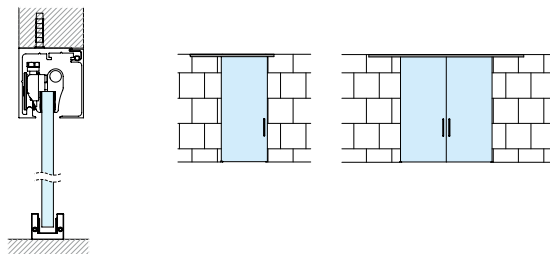

SCORREVOLE A PARETE

Sliding on Wall

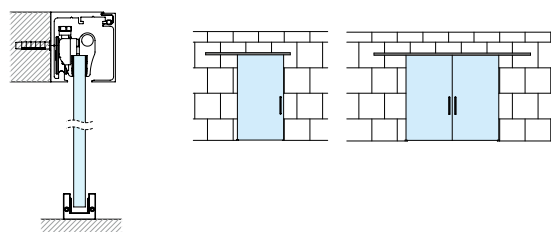

SCORREVOLE SU VETRO FISSO

Sliding on Sidelight

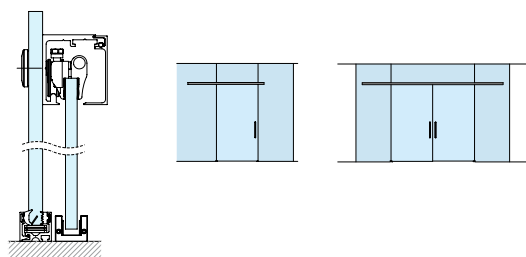

SCORREVOLE A SOFFITTO CON FISSO

Sliding on Ceiling with Sidelight

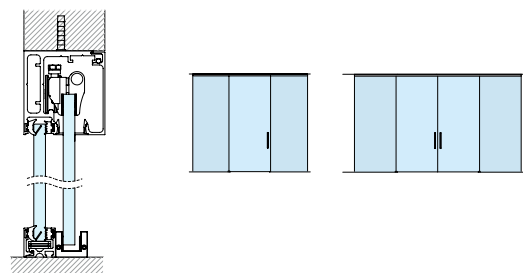

SCORREVOLE A FALSO SOFFITTO

Sliding on False Ceiling

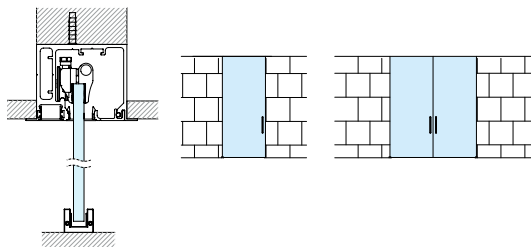

SCORREVOLE A FALSO SOFFITTO CON FISSO

Sliding on False Ceiling with Sidelight

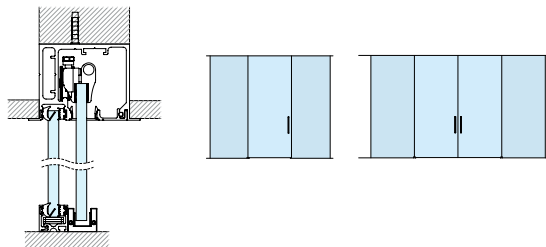

Caratteristiche Tecniche Profili - Profiles Technical Characteristics

SCORREVOLE A SOFFITTO

Sliding on Ceiling

60 x 55.5 mm

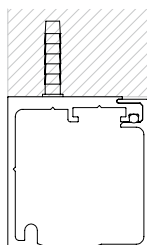

SCORREVOLE A PARETE

Sliding on Wall

60 x 55.5 mm

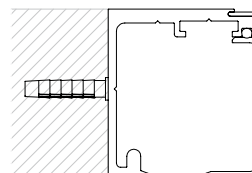

SCORREVOLE SU VETRO FISSO

Sliding on Sidelight

60 x 55.5 mm

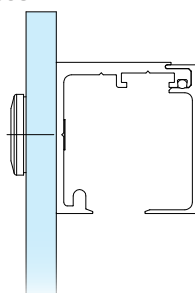

SCORREVOLE A SOFFITTO CON FISSO

Sliding on Ceiling with Sidelight

72 x 69.5 mm

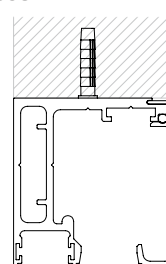

SCORREVOLE A FALSO SOFFITTO

Sliding on False Ceiling

85,4 x 72 mm

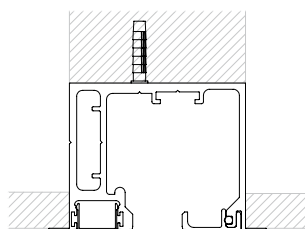

SCORREVOLE A FALSO SOFFITTO CON FISSO

Sliding on False Ceiling with Sidelight

85,4 x 72 mm

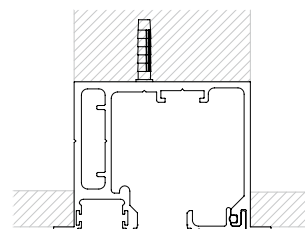

FLUIDO+ 110 PORTE IN LEGNO - WOODEN DOORS

Soluzioni - Solutions

SCORREVOLE A SOFFITTO - PORTA IN LEGNO

Sliding on Ceiling - Wooden Door

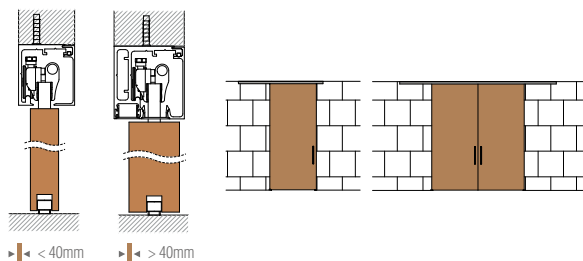

$< 40\text{mm}$ $> 40\text{mm}$

SCORREVOLE A PARETE - PORTA IN LEGNO

Sliding on Wall - Wooden Door

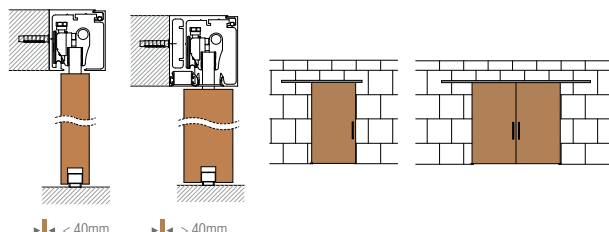

$< 40\text{mm}$ $> 40\text{mm}$

SCORREVOLE A SOFFITTO - PORTA IN LEGNO CON FISSO

Sliding on Ceiling - Wooden Door with Sidelight

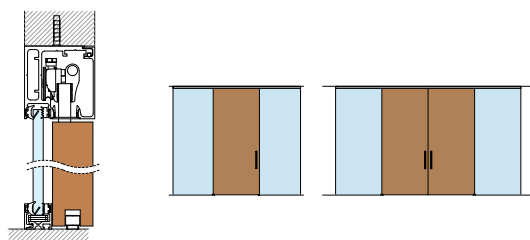

FLUIDO+ 110 PORTE IN LEGNO - WOODEN DOORS

Caratteristiche Tecniche Profili - Profiles Technical Characteristics

SCORREVOLE A SOFFITTO - PORTA IN LEGNO

Sliding on Ceiling - Wooden Door

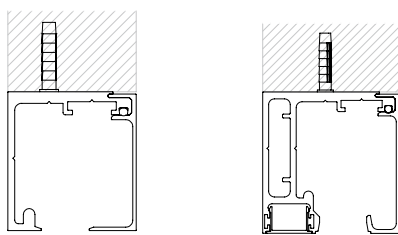

60 x 55.5 mm

72 x 69.5 mm

SCORREVOLE A PARETE - PORTA IN LEGNO

Sliding on Wall - Wooden Door

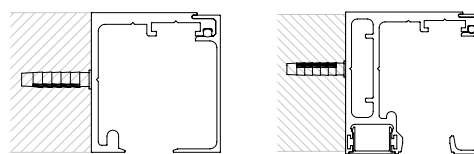

60 x 55.5 mm







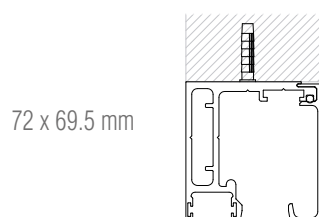









72 x 69.5 mm

SCORREVOLE A SOFFITTO - PORTA IN LEGNO CON FISSO

Sliding on Ceiling - Wooden Door with Sidelight



72 x 69.5 mm

 PORTATA Weight	110kg per porta / for door 242lbs		
 SPESSORE VETRO Glass thickness	10 ÷ 12.76 mm 3/8" to 1/2"		
 SPESSORE PORTA IN LEGNO Wooden door thickness	28 ÷ 50 mm 1 1/8" to 1 15/16"		
 REGOLAZIONE IN ALTEZZA Height adjustment	6 mm 1/4"		
 DISTANZA A PARETE Wall distance	20 mm 13/16"		
 DISTANZA TRA ANTA E VETRO FISSO Distance between door and sidelight	14.8 ÷ 16.2 mm 9/16" to 5/8"		
 INSTALLAZIONE A VETRO Glass installation	✓		
 INSTALLAZIONE A FALSO SOFFITTO False ceiling installation	✓		
 INSTALLAZIONE TRA PARETI Installation between walls	✓		
 SOFTCLOSE Soft close	Doppio / Double		
 DIMENSIONI MINIME (doppio Softclose) Minimum dimensions (double soft close)	922 mm 36 1/4"		
 ANTISHOCK Antishock	Doppio / Double		
 DIMENSIONI MINIME (doppio antishock) Minimum dimensions (double antishock)	700 mm 27 9/16"		
 RETAINER MECCANICO Mechanical retainer	Doppio / Double		
 DIMENSIONI MINIME (doppio Retainer) Minimum dimensions (double Retainer)	700 mm 27 9/16"		
 FINITURE Finishes	02 Ossidato naturale Natural oxidized	05 Ossidato nero Black oxidized	13 PVD simil inox similar PVD stainless steel



**CERTIFICAZIONE DURABILITÀ
CICLI CORROSIONE**
Durability certification
Corrosion cycles

DURABILITÀ (100.000 Cicli)
Durability (100.000 Cycles)

PESO DELLA PORTA (da 101 a 330 kg)
Door mass (from 101 up to 330 kg)

SICUREZZA (Grado 1 per tutti gli scorrevoli)
Safety (All sliding must be grade 1)

RESISTENZA ALLA CORROSIONE (Alta resistenza)
Corrosion resistance (High resistance)

CATEGORIA DELLA PORTA (Porta scorrevole)
Category of door (Sliding door)

FRIZIONE INIZIALE VALORE MASSIMO CONSENTITO (4% della massa)
Initial friction maximum permitted value (4% of the mass)

according to
EN1527

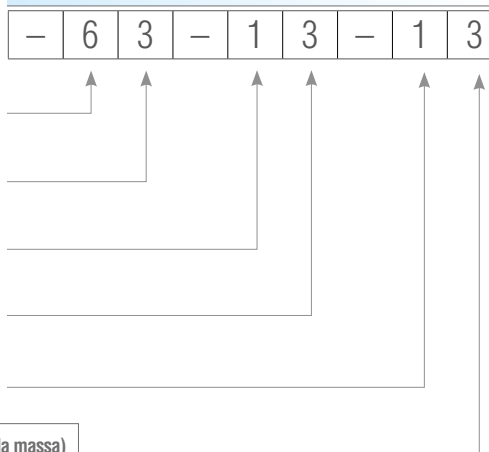

FLUIDO+ 110

scorrevole a soffitto
sliding on ceiling

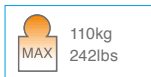
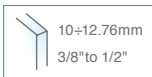

- Profili per scorrevole
- fissaggio a soffitto/parete.
- Perfil para sistema corredero
- fijación a techo/pared.
- Profiles for sliders
- fixed on ceiling/wall.
- Schiebeseystem Fluido
- Befestigung an der Decke/Wand.
- Profils pour coulissants
- fixation au plafond/mur.

LUNGHEZZE PROFILI - LENGTH OF PROFILES

B110EK00/2 (2 mt)

B110EK00/3 (3 mt)

B110EK00/4 (4 mt)

B110EK00/6 (6 mt)

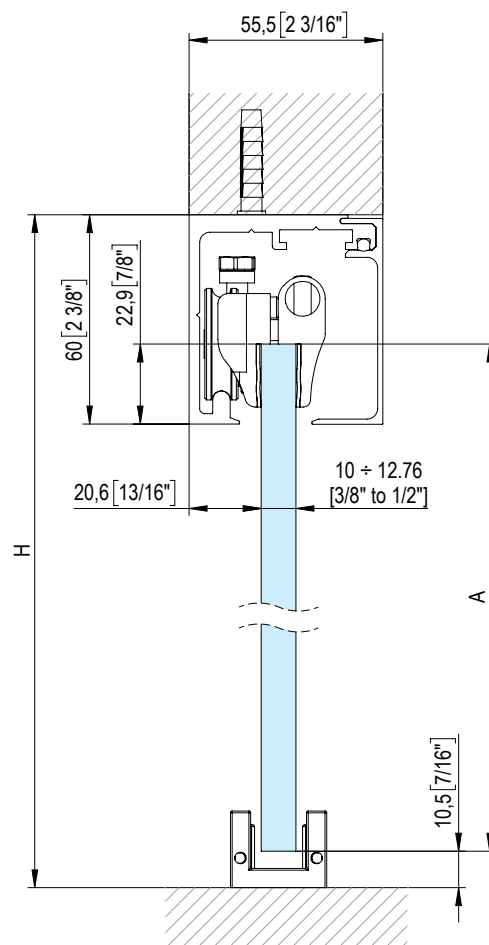
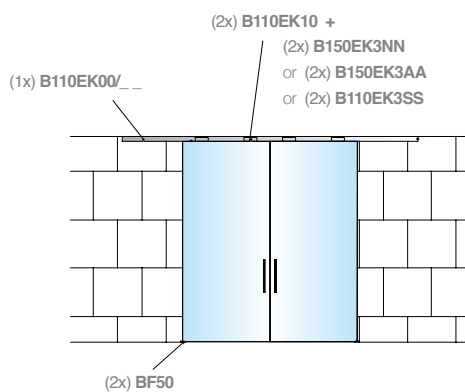
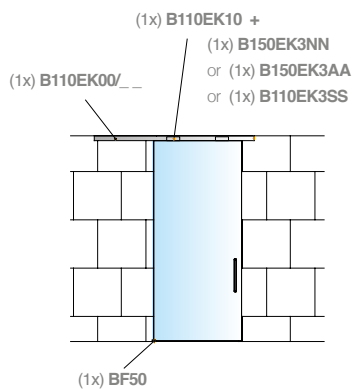
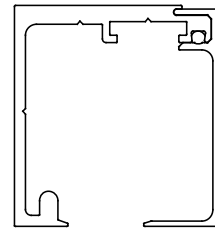

$$A = H - 48$$

$$[A = H - 1 7/8"]$$

L'installazione del Fluido 70, 110 e 150 non necessita di forature sul vetro. La instalación del "Fluido 70, 110 y 150" no necesita agujeros en el cristal. The installation of Fluido 70, 110 and 150 does not need holes on the glass. Die Systeme Fluido 70, 110 und 150 benötigen keine Glasbearbeitung. L'installation des coulissants Fluido 70, 110 et 150 ne requiert pas de perçage du verre.

FLUIDO+ 110

scorrevole a parete
sliding on wall

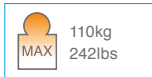
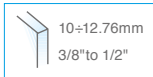

- Profili per scorrevole
- fissaggio a soffitto/parete.
- Perfil para sistema corredero
- fijación a techo/pared.
- Profiles for sliders
- fixed on ceiling/wall.
- Schiebeseystem Fluido
- Befestigung an der Decke/Wand.
- Profils pour coulissants
- fixation au plafond/mur.

LUNGHEZZE PROFILI - LENGTH OF PROFILES

B110EK00/2 (2 mt)

B110EK00/3 (3 mt)

B110EK00/4 (4 mt)

B110EK00/6 (6 mt)

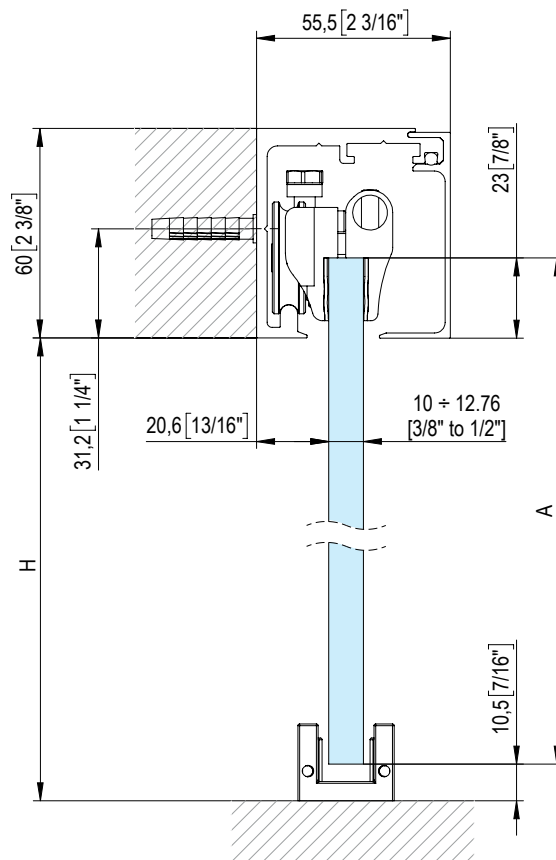
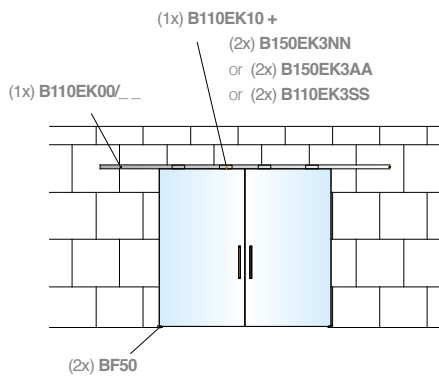
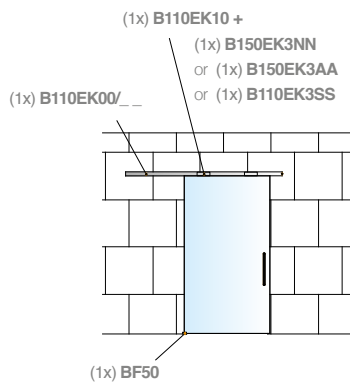
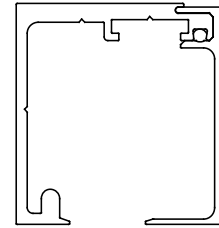

$$A = H + 12$$

$$[A = H + 1/2"]$$

L'installazione del Fluido 70, 110 e 150 non necessita di forature sul vetro. La instalación del "Fluido 70, 110 y 150" no necesita agujeros en el cristal. The installation of Fluido 70, 110 and 150 does not need holes on the glass. Die Systeme Fluido 70, 110 und 150 benötigen keine Glasbearbeitung. L'installation des coulissants Fluido 70, 110 et 150 ne requiert pas de perçage du verre.

FLUIDO+ 110

scorrevole su vetro fisso
sliding on sidelight

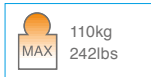
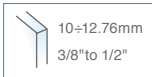

- Profili per scorrevole
- fissaggio a soffitto/parete.
- Perfil para sistema corredero
- fijación a techo/pared.
- Profiles for sliders
- fixed on ceiling/wall.
- Schiebesystem Fluido
- Befestigung an der Decke/Wand.
- Profils pour coulissants
- fixation au plafond/mur.

LUNGHEZZE PROFILI - LENGTH OF PROFILES

- B110EK00/2 (2 mt)
- B110EK00/3 (3 mt)
- B110EK00/4 (4mt)
- B110EK00/6 (6mt)

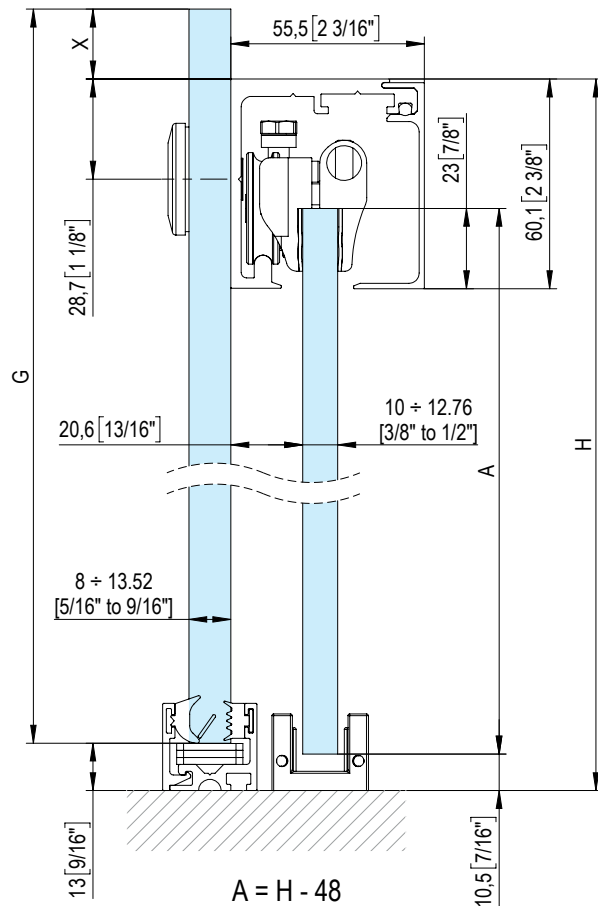
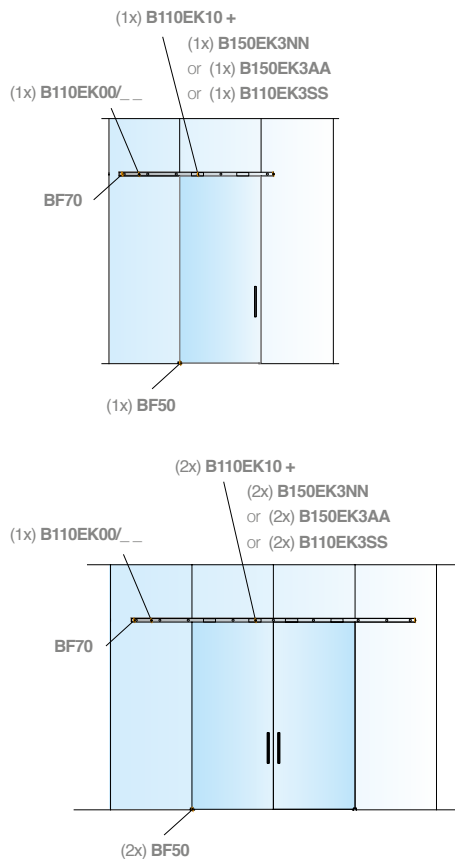
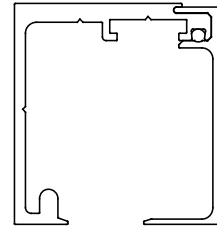

NON INCLUSI - NOT INCLUDED

P20EJ0810/6 P20EJ1113/6 P20E29/58



Vedere scheda catalogo P20E nella sezione PARTIZIONI
See P20E technical sheet in PARTITIONING section

$$A = H - 48$$

$$[A = H - 1 7/8"]$$

$$G = H + X - 13$$

$$[A = H + X - 1/2"]$$

L'installazione del Fluido 70, 110 e 150 non necessita di forature sul vetro. La instalación del "Fluido 70, 110 y 150" no necesita agujeros en el cristal. The installation of Fluido 70, 110 and 150 does not need holes on the glass. Die Systeme Fluido 70, 110 und 150 benötigen keine Glasbearbeitung. L'installation des coulissants Fluido 70, 110 et 150 ne requiert pas de perçage du verre.

FLUIDO+ 110

scorrevole a soffitto con fisso
sliding on ceiling with sidelight

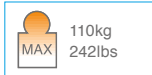

- Profili per scorrevole
- fissaggio a soffitto con vetro fisso.
- Perfil para sistema corredero
- fijación a techo con vidrio fijo.
- Profiles for sliders
- fixed on ceiling with fixed glass.
- Schiebeseystem Fluido
- Befestigung an Decke mit Seitenteilen aus Glas.
- Profils pour coulissant
- fixation au plafond avec verre fixe.

LUNGHEZZE PROFILI - LENGTH OF PROFILES

- B110EK01/2 (2 mt)
- B110EK01/3 (3 mt)
- B110EK01/4 (4 mt)
- B110EK01/6 (6 mt)

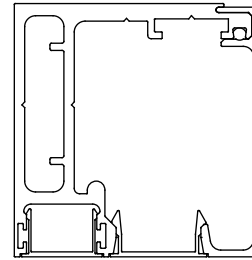

OPTIONAL

- | | |
|------------------|------------------|
| B150EP45/2 (2mt) | B150EP46/2 (2mt) |
| B150EP45/3 (3mt) | B150EP46/3 (3mt) |
| B150EP45/4 (4mt) | B150EP46/4 (4mt) |
| B150EP45/6 (6mt) | B150EP46/6 (6mt) |

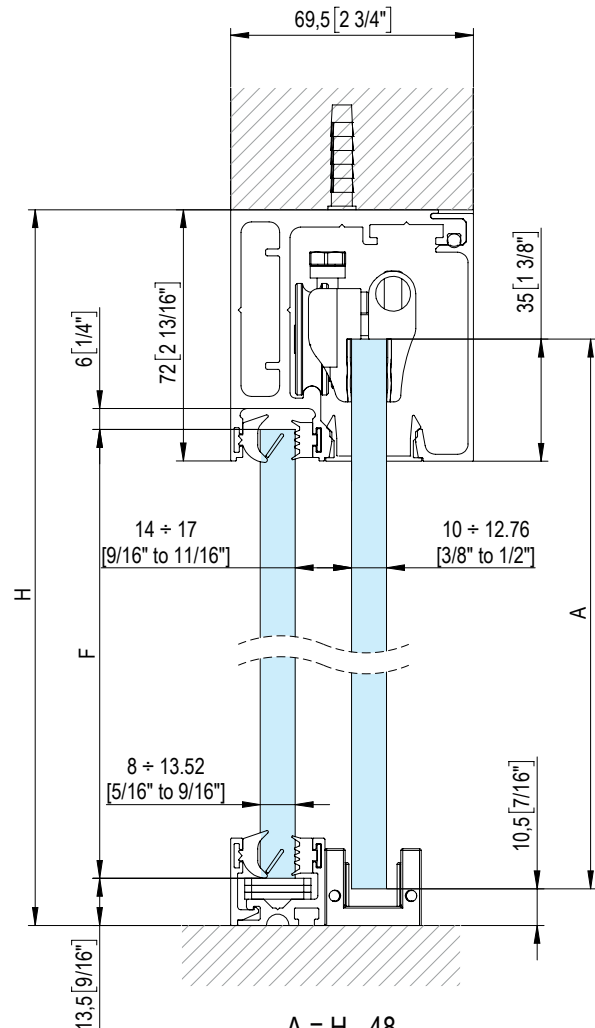
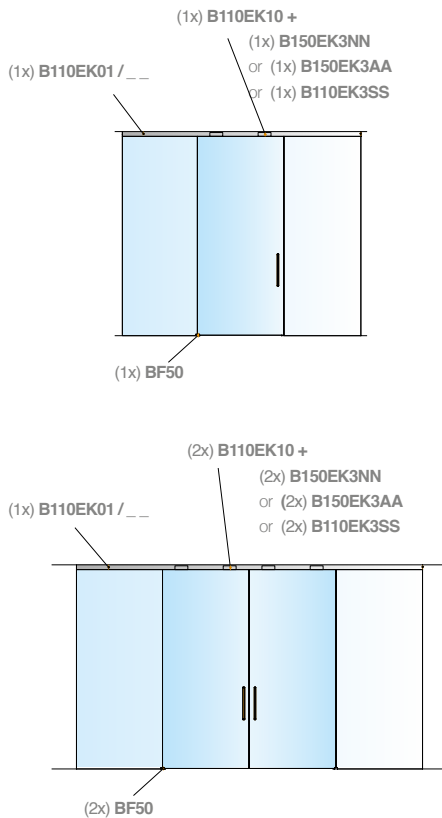

NON INCLUSI - NOT INCLUDED

P20EJ0810/6 P20EJ1113/6 P20E29/58



Vedere scheda catalogo P20E nella sezione PARTIZIONI
See P20E technical sheet in PARTITIONING section

$$A = H - 48$$

$$[A = H - 1 7/8"]$$

$$F = H - 77$$

$$[F = H - 3 1/16"]$$

L'installazione dei Fluido 70, 110 e 150 non necessita di forature sul vetro. La instalación del "Fluido 70, 110 y 150" no necesita agujeros en el cristal. The installation of Fluido 70, 110 and 150 does not need holes on the glass. Die Systeme Fluido 70, 110 und 150 benötigen keine Glasbearbeitung. L'installation des coulissants Fluido 70, 110 et 150 ne requiert pas de perçage du verre.

FLUIDO+ 110

scorrevole a falso soffitto
sliding on false ceiling

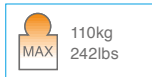

- Profili per scorrevole
- fissaggio a falso soffitto.
- Perfil para sistema corredero
- fijación a cielo falso.
- Kit profiles for sliders
- fixed on false ceiling.
- Profil für Schiebesystem
- Befestigung an abgehängter Decke.
- Profils pour portes coulissantes
- fixation sur faux-plafond.

! Disponibile da Marzo 2021
Available from March 2021

LUNGHEZZE PROFILI - LENGTH OF PROFILES

- B110EK02/2 (2 mt)
- B110EK02/3 (3 mt)
- B110EK02/4 (4 mt)
- B110EK02/6 (6 mt)

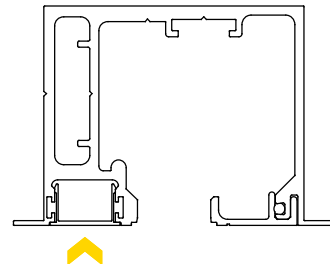

OPTIONAL

- B150EP45/2 (2mt)
- B150EP45/3 (3mt)
- B150EP45/4 (4mt)
- B150EP45/6 (6mt)

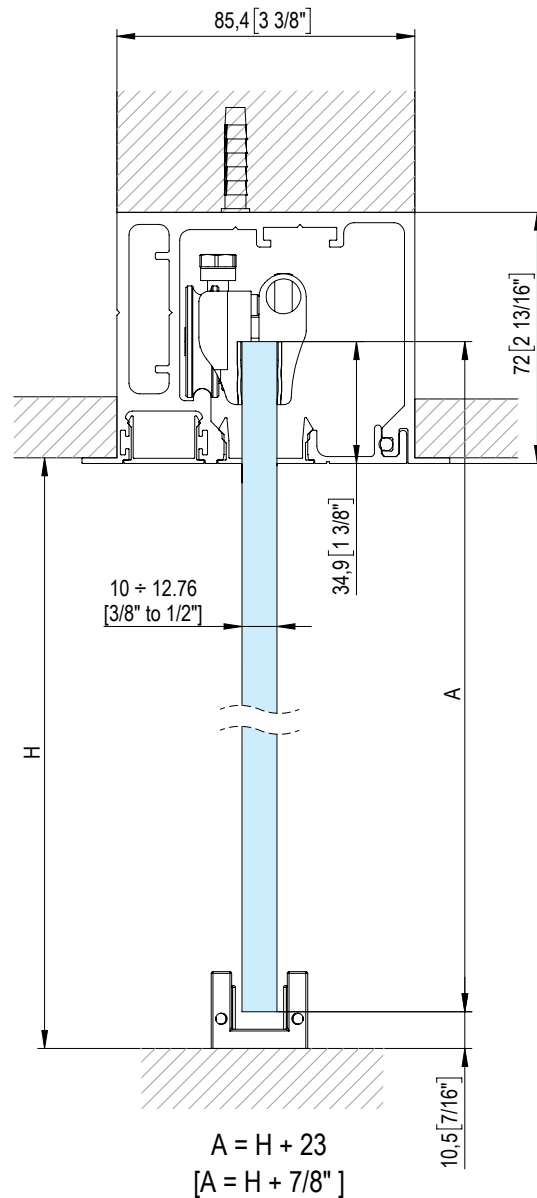
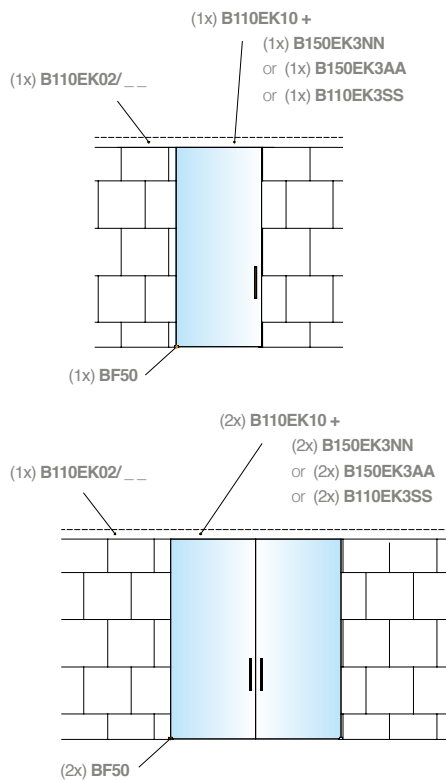

L'installazione del Fluido 70, 110 e 150 non necessita di forature sul vetro. La instalación del "Fluido 70, 110 y 150" no necesita hojas en el cristal. The installation of Fluido 70, 110 and 150 does not need holes on the glass. Die Systeme Fluido 70, 110 und 150 benötigen keine Glasbearbeitung. L'installation des coulissants Fluido 70, 110 et 150 ne requiert pas de perçage du verre.

FLUIDO+ 110

scorrevole a falso soffitto con fisso
sliding on false ceiling with sidelight

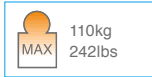
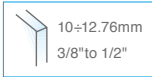

- Profili per scorrevole
- fissaggio a falso soffitto con vetro fisso.
- Perfil para sistema corredor
- fijación a cielo falso con vidrio fijo.
- Profiles for sliders
- fixed on false ceiling with fixed glass.
- Profil für Schiebeseiten - Befestigung an abgehängter Decke mit Glasseitenteil.
- Profils pour coulissants
- fixation faux-plafond avec verre fixe.

! Disponibile da Marzo 2021
Available from March 2021

LUNGHEZZE PROFILI - LENGTH OF PROFILES

- B110EK02/2 (2 mt)
- B110EK02/3 (3 mt)
- B110EK02/4 (4 mt)
- B110EK02/6 (6 mt)

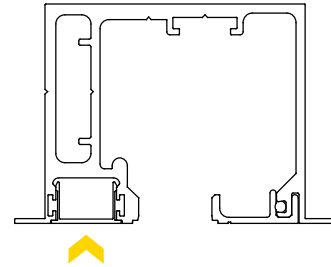

OPTIONAL

- B150EP45/2 (2mt)
- B150EP45/3 (3mt)
- B150EP45/4 (4mt)
- B150EP45/6 (6mt)

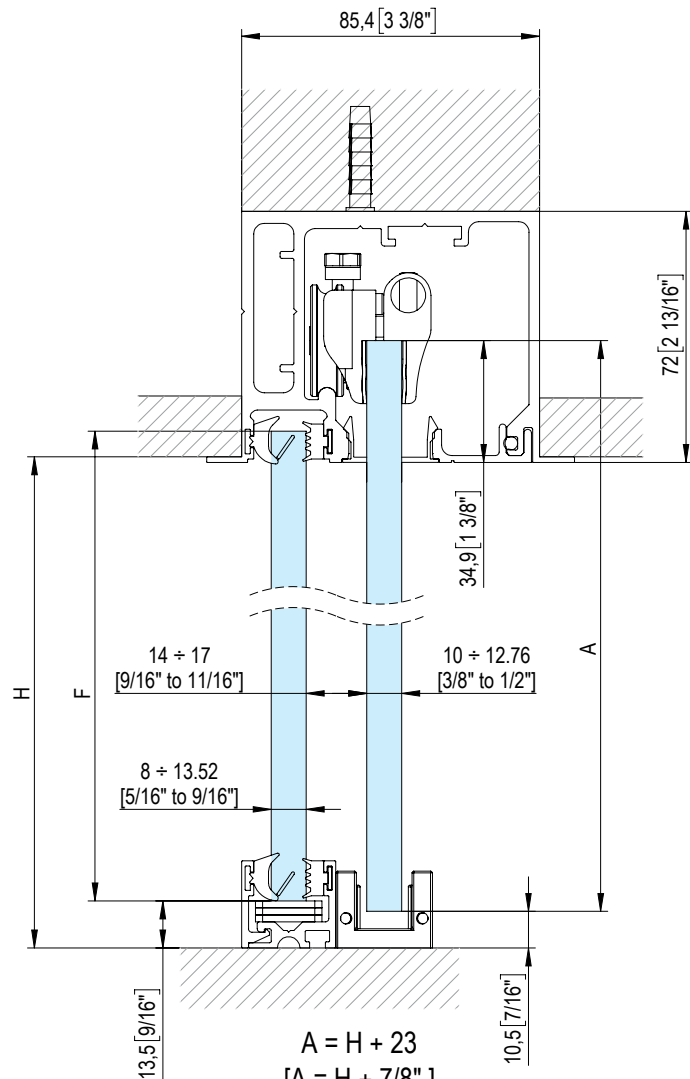
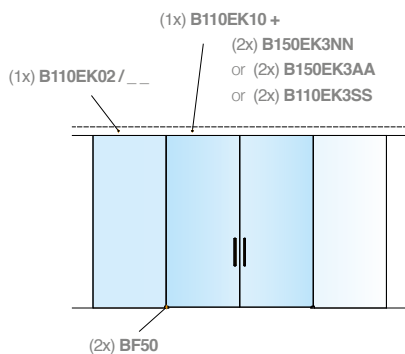
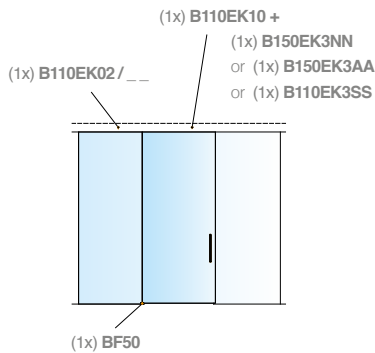

$$A = H + 23$$

$$[A = H + 7/8"]$$

$$F = H - 6$$

$$[F = H - 1/4"]$$

NON INCLUSI - NOT INCLUDED

P20EJ0810/6

P20EJ1113/6

P20E29/58



Vedere scheda catalogo P20E nella sezione PARTIZIONI
See P20E technical sheet in PARTITIONING section

L'installazione dei Fluido 70, 110 e 150 non necessita di forature sul vetro. La instalación del "Fluido 70, 110 y 150" no necesita hojas en el cristal. The installation of Fluido 70, 110 and 150 does not need holes on the glass. Die Systeme Fluido 70, 110 und 150 benötigen keine Glasbearbeitung. L'installation des coulissants Fluido 70, 110 et 150 ne requiert pas de perçage du verre.

FLUIDO+ 110



scorrevole a soffitto - porta in legno
sliding on ceiling - wooden door

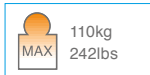

- Profili per scorrevole in legno
- fissaggio a soffitto.
- Perfil para sistema corredero - puertas de madera
- fijación a techo.
- Profiles for sliders - wooden doors
- fixed on ceiling.
- Schiebeseystem Fluido - Holztüren
- Befestigung an der Decke.
- Profils pour coulissants - Portes en bois
- fixation au plafond.

LUNGHEZZE PROFILI - LENGTH OF PROFILES

B110EK00/2 (2 mt)

B110EK00/3 (3mt)

B110EK00/4 (4mt)

B110EK00/6 (6mt)

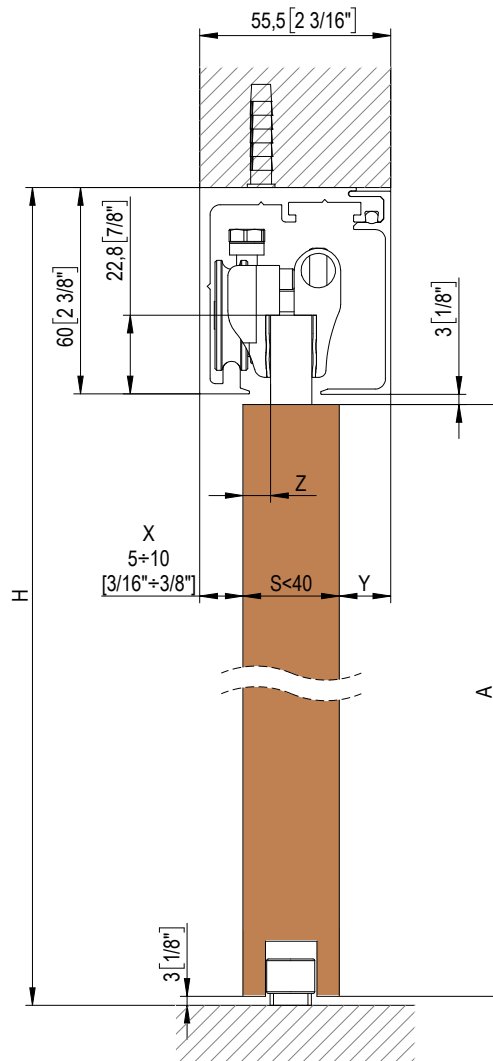
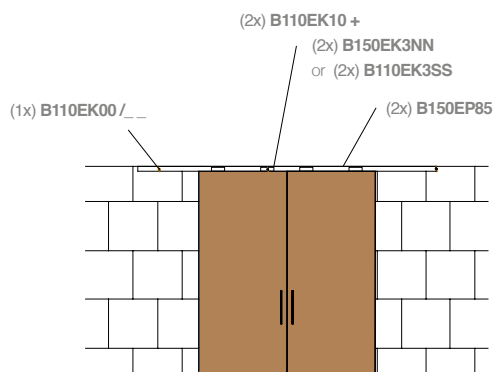
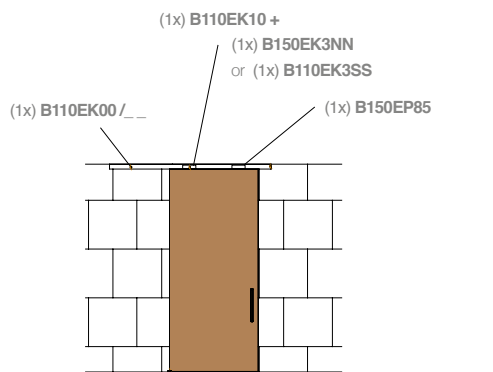
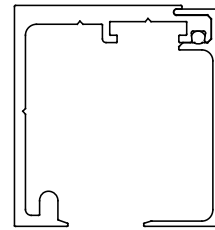

$$\begin{aligned}
 A &= H - 66 \\
 [A &= H - 2 \ 5/8"] \\
 Y &= 55.5 - X - S \\
 [Y &= [2 \ 3/16" - X - S] \\
 Z &= 20 - X \\
 [Z &= 13/16" - X]
 \end{aligned}$$

FLUIDO+ 110



scorrevole a soffitto - porta in legno
sliding on ceiling - wooden door

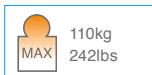
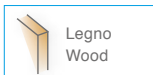

- Profili per scorrevole in legno
- fissaggio a soffitto.
- Perfil para sistema corredero - puertas de madera
- fijación a techo.
- Profiles for sliders - wooden doors
- fixed on ceiling.
- Schiebeseystem Fluido - Holztüren
- Befestigung an der Decke.
- Profils pour coulissants - Portes en bois
- fixation au plafond.

LUNGHEZZE PROFILI - LENGTH OF PROFILES

- B110EK01/2** (2 mt)
- B110EK01/3** (3 mt)
- B110EK01/4** (4 mt)
- B110EK01/6** (6 mt)

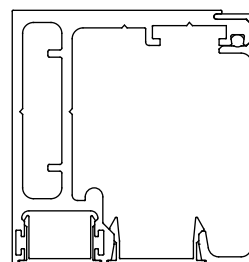

OPTIONAL

- | | |
|------------------|------------------|
| B150EP45/2 (2mt) | B150EP46/2 (2mt) |
| B150EP45/3 (3mt) | B150EP46/3 (3mt) |
| B150EP45/4 (4mt) | B150EP46/4 (4mt) |
| B150EP45/6 (6mt) | B150EP46/6 (6mt) |

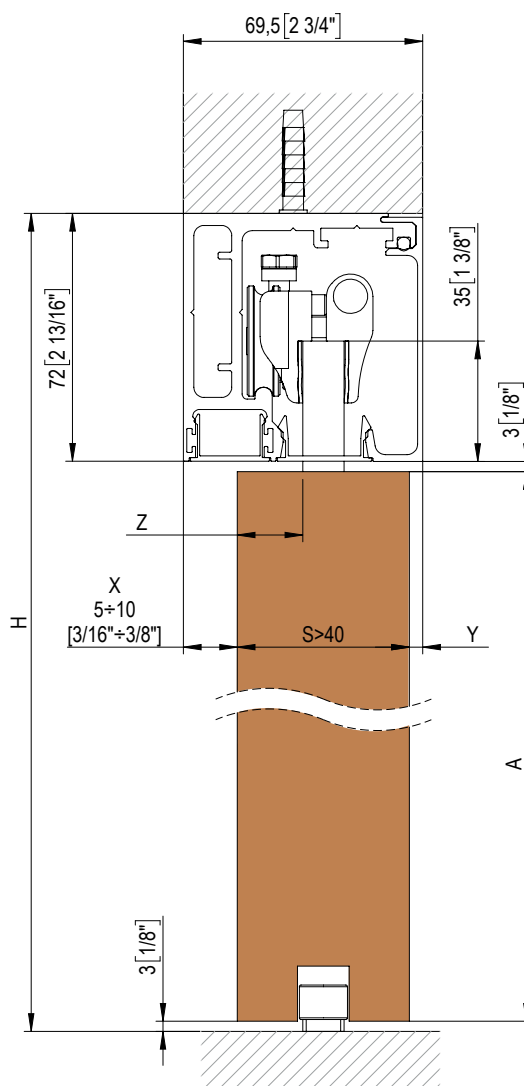
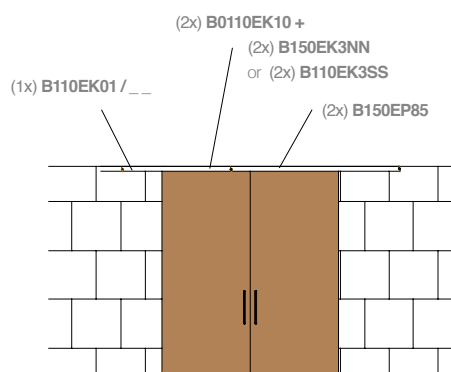
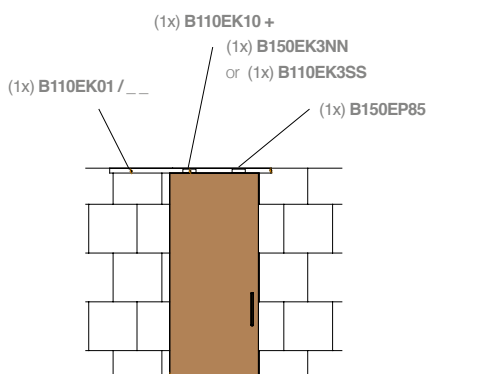

$$\begin{aligned}
 A &= H - 78 \\
 [A &= H - 3 \frac{1}{16}"] \\
 Y &= 69.5 - X - S \\
 [Y &= [2 \frac{3}{4} - X - S] \\
 Z &= 34 - X \\
 [Z &= 1 \frac{5}{16} - X]
 \end{aligned}$$

FLUIDO+ 110



scorrevole a parete - porta in legno
sliding on wall - wooden door

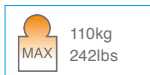

- Profili per scorrevole in legno
- fissaggio a parete.
- Perfil para sistema corredero - puertas de madera
- fijación a pared.
- Profiles for sliders - wooden doors
- fixed on wall.
- Schiebeseystem Fluido - Holztüren
- Befestigung an der Wand.
- Profils pour coulissants - Portes en bois
- fixation au mur.

LUNGHEZZE PROFILI - LENGTH OF PROFILES

B110EK00/2 (2 mt)

B110EK00/3 (3 mt)

B110EK00/4 (4mt)

B110EK00/6 (6mt)

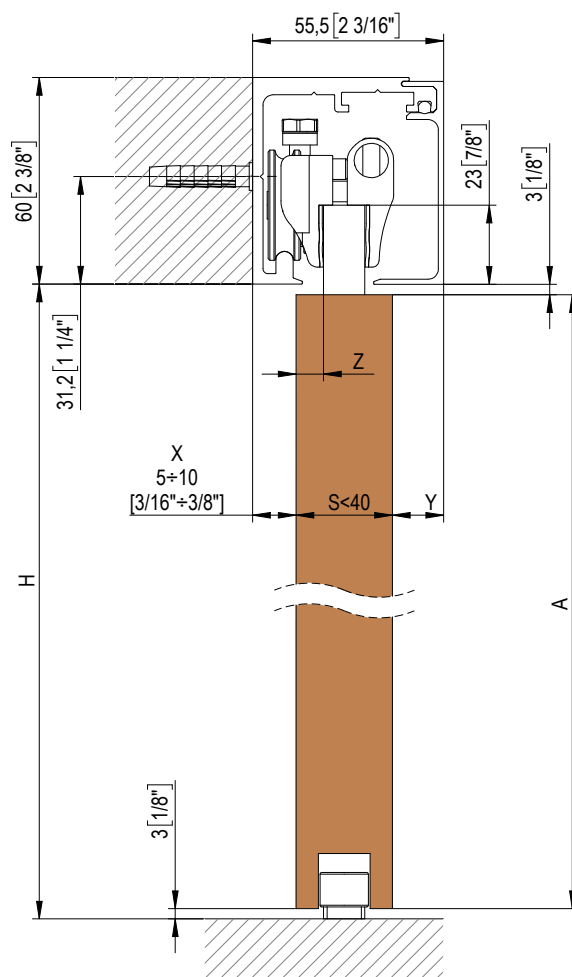
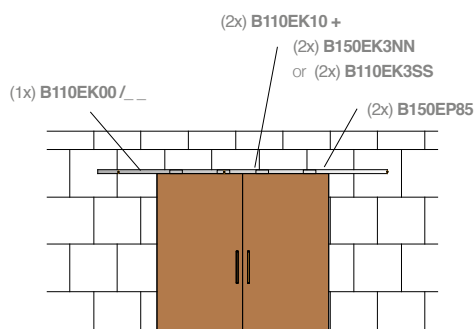
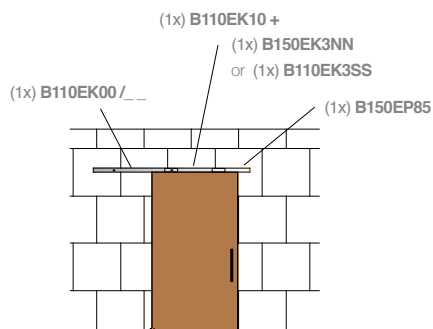
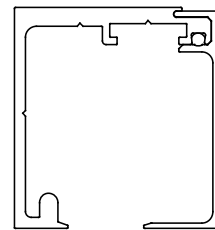

$$\begin{aligned}
 A &= H - 6 \\
 [A &= H - 1/4"] \\
 Y &= 55.5 - X - S \\
 [Y &= [2 \ 3/16" - X - S] \\
 Z &= 20 - X \\
 [Z &= 13/16" - X]
 \end{aligned}$$

FLUIDO+ 110



scorrevole a parete - porta in legno
sliding on wall - wooden door

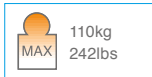

- Profili per scorrevole in legno
- fissaggio a parete.
- Perfil para sistema corredero - puertas de madera
- fijación a pared.
- Profiles for sliders - wooden doors
- fixed on wall.
- Schiebesystem Fluido - Holztüren
- Befestigung an der Wand.
- Profils pour coulissants - Portes en bois
- fixation au mur.

LUNGHEZZE PROFILI - LENGTH OF PROFILES

- B110EK01/2 (2 mt)
- B110EK01/3 (3 mt)
- B110EK01/4 (4 mt)
- B110EK01/6 (6 mt)

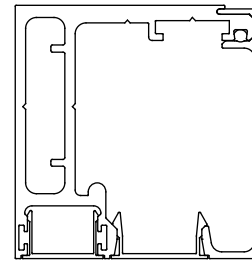

OPTIONAL

- | | |
|------------------|------------------|
| B150EP45/2 (2mt) | B150EP46/2 (2mt) |
| B150EP45/3 (3mt) | B150EP46/3 (3mt) |
| B150EP45/4 (4mt) | B150EP46/4 (4mt) |
| B150EP45/6 (6mt) | B150EP46/6 (6mt) |

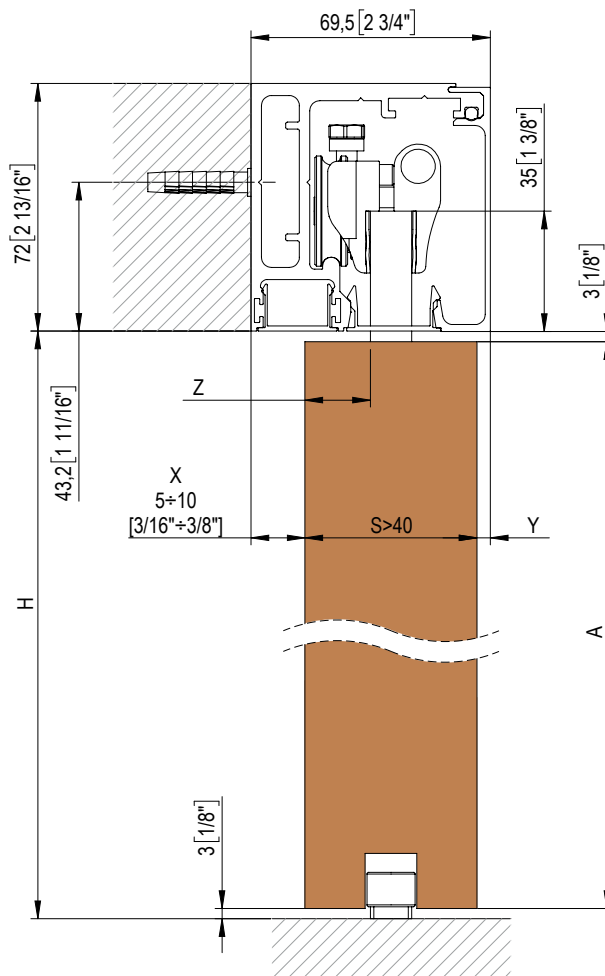
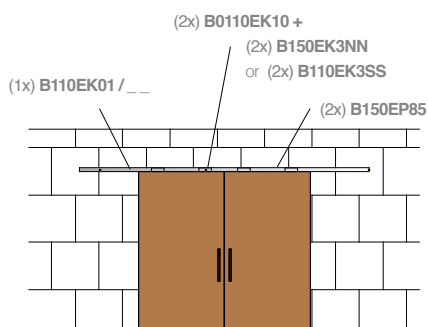
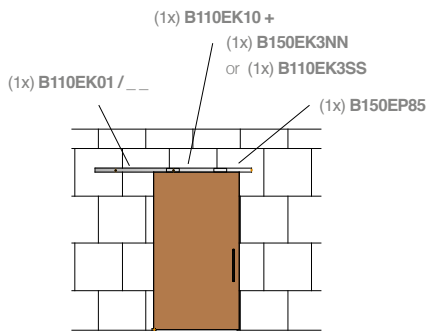

$$\begin{aligned}
 A &= H - 6 \\
 [A &= H - 1/4"] \\
 Y &= 69.5 - X - S \\
 [Y &= [2 3/4" - X - S] \\
 Z &= 34 - X \\
 [Z &= 1 5/16" - X]
 \end{aligned}$$

FLUIDO+ 110 -KIT

Components

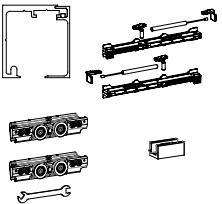
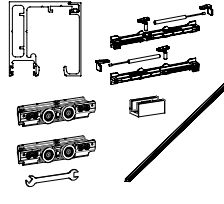
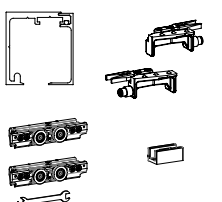
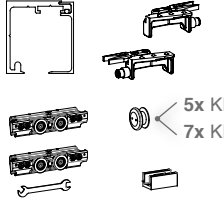
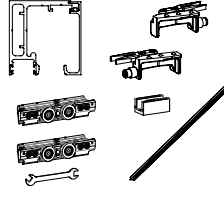
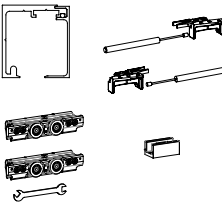
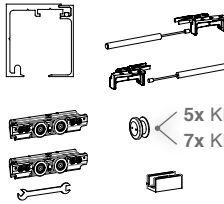
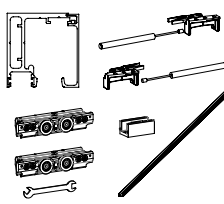
<p>KB110CS0/2</p> <p>KB110CS0/3</p> <ul style="list-style-type: none"> • Kit scorrevole parete/soffitto con doppio soft-close. • Kit corredizo de pared / techo con doble Soft-close • Sliding wall / ceiling kit with double soft-close • Schiebewand- / Deckensatz mit doppelem Soft-Close • Kit mur / plafond coulissant à double Soft-Close. 	<p>KB110SS0/2</p> <p>KB110SS0/3</p> <ul style="list-style-type: none"> • Kit scorrevole su vetro fisso con doppio soft-close. • Kit corredizo sobre vidrio fijo con doble Soft-close • Sliding kit on fixed glass with double soft-close • Schiebesatz auf festem Glas mit doppelem Soft-Close • Kit coulissant sur verre fixe avec double Soft-Close  <p>5x KB110SS0/2 7x KB110SS0/3</p>	<p>KB110FS0/2</p> <p>KB110FS0/3</p> <ul style="list-style-type: none"> • Kit scorrevole a soffitto con fisso, con doppio soft-close. • Kit de techo corredizo fijo con doble Soft-close • Fixed sliding ceiling kit with double soft-close • Festes Schiebedeckenset mit doppelem Soft-Close • Kit plafond fixe coulissant avec à double Soft-Close 
<p>KB110CM0/2</p> <p>KB110CM0/3</p> <ul style="list-style-type: none"> • Kit scorrevole parete/soffitto con retainer e stop meccanico. • Kit corredizo de techo / pared con retenedor y tope mecánico • Sliding wall / ceiling kit with retainer and mechanical stop • Schiebewand- / Deckensatz mit Halterung und mechanischem Anschlag • Kit mur / plafond coulissant avec arrêtoir et butée mécanique 	<p>KB110SM0/2</p> <p>KB110SM0/3</p> <ul style="list-style-type: none"> • Kit scorrevole su vetro fisso con retainer e stop meccanico. • Kit corredizo sobre vidrio fijo con retenedor y tope mecánico • Sliding kit on fixed glass with retainer and mechanical stop • Schiebesatz auf festem Glas mit Halter und mechanischem Anschlag • Kit coulissant sur verre fixe avec arrêtoir et butée mécanique  <p>5x KB110SM0/2 7x KB110SM0/3</p>	<p>KB110FM0/2</p> <p>KB110FM0/3</p> <ul style="list-style-type: none"> • Kit scorrevole a soffitto con fisso, con retainer e stop meccanico. • Kit de techo corredizo fijo, con retenedor y tope mecánico. • Sliding ceiling kit with fixed, with retainer and mechanical stop • Schiebedeckensatz mit fester, mit Halterung und mechanischem Anschlag • Kit plafond coulissant avec fixe, avec arrêtoir et butée mécanique 
<p>KB110CA0/2</p> <p>KB110CA0/3</p> <ul style="list-style-type: none"> • Kit scorrevole parete/soffitto con retainer e antishock. • Kit corredizo de pared / techo con retenedor y Antishock • Sliding wall / ceiling kit with retainer and Antishock • KSchiebewand- / Deckensatz mit Halter und Antishock • Kit mur / plafond coulissant avec retenue et Antishock 	<p>KB110SA0/2</p> <p>KB110SA0/3</p> <ul style="list-style-type: none"> • Kit scorrevole su vetro fisso con retainer e antishock. • Kit corredizo sobre vidrio fijo con retenedor y Antishock • Sliding kit on fixed glass with retainer and Antishock • Schiebesatz auf festem Glas mit Halter und Antishock • Kit coulissant sur verre fixe avec retenue et Antishock  <p>5x KB110SA0/2 7x KB110SA0/3</p>	<p>KB110FA0/2</p> <p>KB110FA0/3</p> <ul style="list-style-type: none"> • Kit scorrevole a soffitto con fisso, con retainer e antishock. • Kit de techo corredizo con fija, con retenedor y Antishock • Sliding ceiling kit with fixed, with retainer and Antishock • Schiebedecken-Kit mit fester, mit Halter und Antishock • Kit plafond coulissant avec fixe, avec retenue et Antishock 

FLUIDO+ 110- KIT PINZE

Clamps kit

B110EK10



- Kit coppia pinze con chiave
- Kit par de pinzas con llave
- Kit with pair of clamps with key
- Bausatz ein Paar Zangen mit Schlüssel
- Kit paire de pinces avec clé

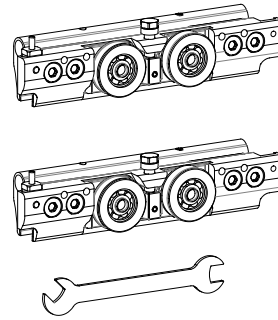

B150EK3NN



- Kit coppia Retainer. Stop meccanico
- Kit par tope mecánico
- Kit with pair of mechanical stops
- Bausatz ein Paar mechanische Stopper
- Kit paire arrêt mécanique

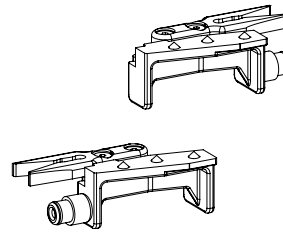

B150EK3AA



- Kit coppia Retainer + Antishock
- Kit par tope mecánico + antichoque
- Kit with pair of mechanical stops and anti-shock feature
- Bausatz ein Paar mechanische Stopper + Antishock
- Kit paire arrêt mécanique + butée antichoc

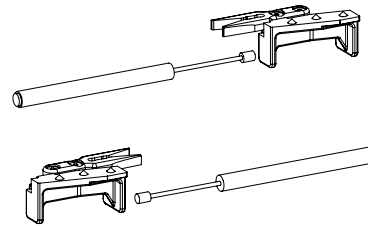

B110EK3SS



- Kit coppia Soft Close CPCS
- Kit par Soft Close CPCS
- Kit with Soft Close CPCS pair
- Bausatz ein Paar Soft Close CPCS
- Kit paire Soft Close CPCS

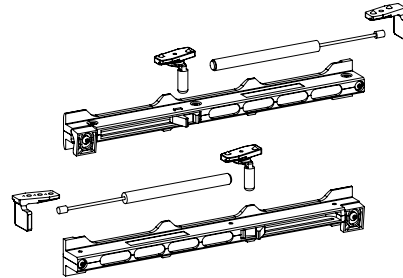

B110EP73

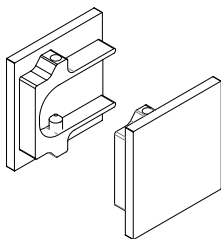

- Coppia di tappi.
- Par de tapones
- Pair of caps
- Paar Kappen
- Paire de bouchons

B110EP74

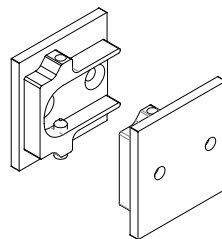

- Coppia di tappi forati.
- Par de tapones perforados
- Pair of perforated caps
- Paar Lochkappen
- Paire de bouchons perforés

B110EP75

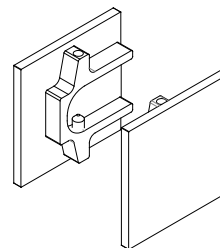

- Coppia di tappi per versione con fisso laterale.
- Par de tapones para versión con cristal fijo lateral
- Pair of caps for model with side fixed glass
- Paar Kappen für Version mit festem Seitenglas
- Paire de bouchons pour version avec vitrage fixe latéral

B110EP76

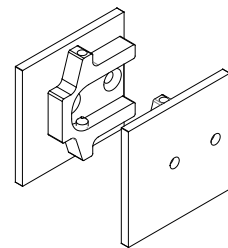

- Coppia di tappi forati per versione con fisso laterale.
- Par de tapones perforados para versión con cristal fijo lateral
- Pair of perforated caps for model with side fixed glass
- Paar Lochkappen für Version mit festem Seitenglas
- Paire de bouchons perforés pour version avec vitrage fixe latéral

FLUIDO+ 110 - COMPONENTI

Components

B110EP64

- Spessore per Veletta - Consigliato per binari oltre i 2,5m
- Cuña para panel - Aconsejado para perfiles de largo superior a 2,5 m
- Spacer for casing - Recommended for rails longer than 2,5 m
- Distanzstück für Anlauf - Empfohlen für Profilen über 2,5 m
- Épaisseur pour panneau - Recommandé pour les profils de plus de 2,5 m

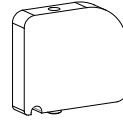

B110EP77

- Coppia supporti laterali
- Par de soportes laterales
- Pair of side fittings
- Paar Seitenträger
- Paire de supports latéraux

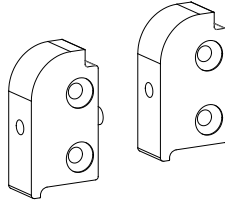

B150EP48

- Tassello di collegamento - per vetro fisso
- Pieza de unión - para cristal fijo
- Connection insert - for fixed glass
- Verbindungsdübel - für festem Glas
- Tasseau d'assemblage - pour vitrage fixe

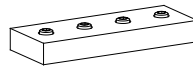

BF50

- Guida a terra.
- Guía de suelo
- Ground slide
- Bodenführung
- Guide au sol

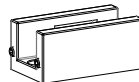

B150EP85

- Kit accessorio per porte in legno.
- Kit accesorios para puertas de madera.
- Accessory kit for wooden doors.
- Zubehörkit für Holztüren.
- Kit accessoires pour portes en bois.

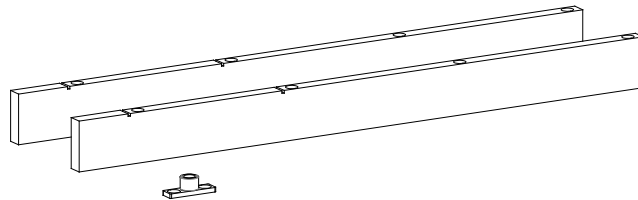

BF70

- Borchia per fissaggio barra a vetro.
- Perno de fijación de la barra al cristal
- Boss for securing glass bar
- Senkschraube zur Befestigung der Stange am Glas
- Clou de fixation de la barre à la vitre

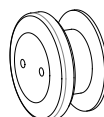

Lunghezza barra	Quantità borchie
Longitud de la barra Bar length Profillänge Longueur de barre	Cantidad tornillos Quantity of studs Anzahl der Stifte Quantité
2 mt	5
3,2 mt	8
4 mt	10
6 mt	15

B150EP27

- Perno per porte battenti da applicare ad estrusi Fluido+.
- Pernio para puertas batientes, por aplicar a perfiles Fluido+.
- Spindle for swing doors, to be applied to Fluido+ profiles.
- Drehpunkt für Pendeltüren für Fluido+ Profilen.
- Pivot pour portes battantes à appliquer sur profils Fluido+.

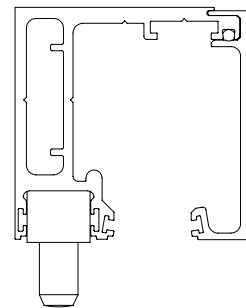
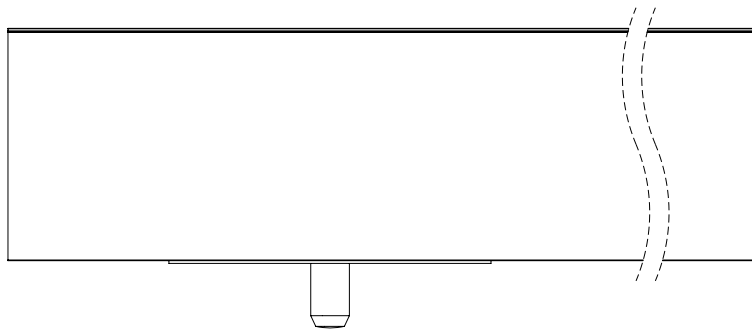
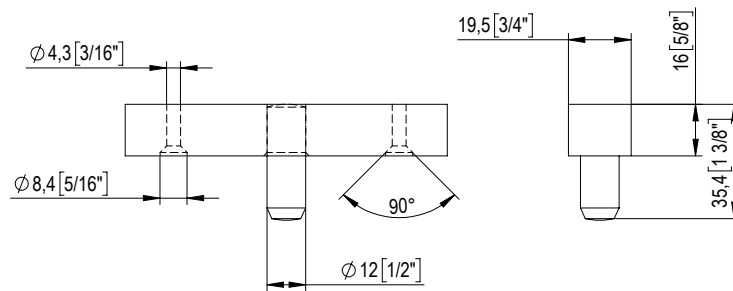
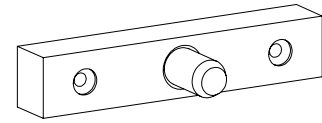
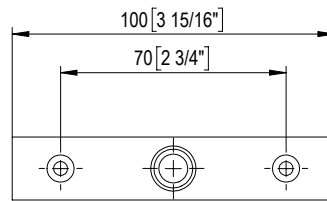

ESEMPIO APPLICAZIONE CON CERNIERA UNICA 101E10 - 100E20

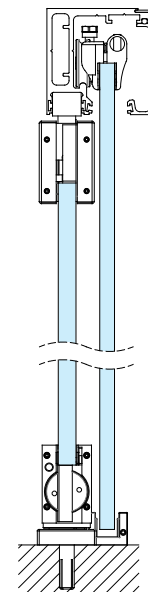
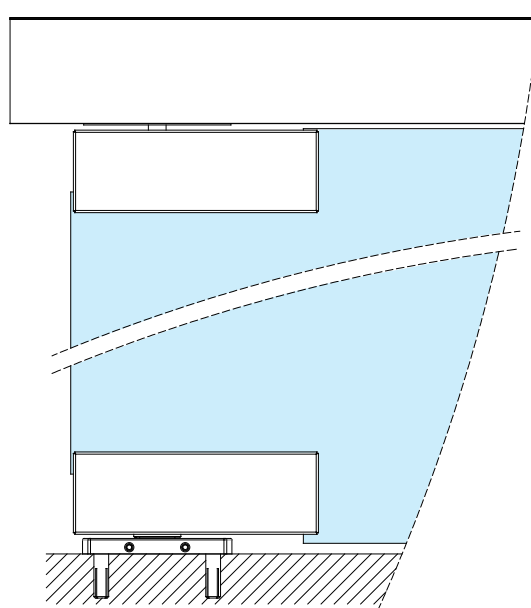
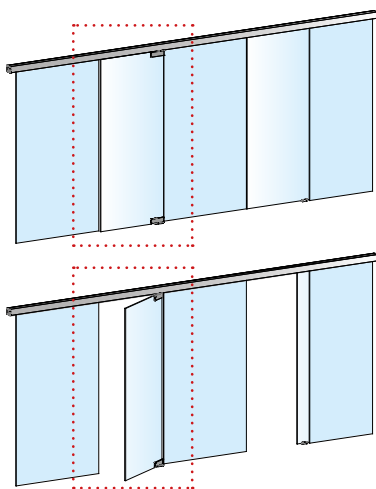



FLUIDO+ 150 PORTE IN VETRO - GLASS DOORS

Soluzioni - Solutions

SCORREVOLE A SOFFITTO

Sliding on Ceiling

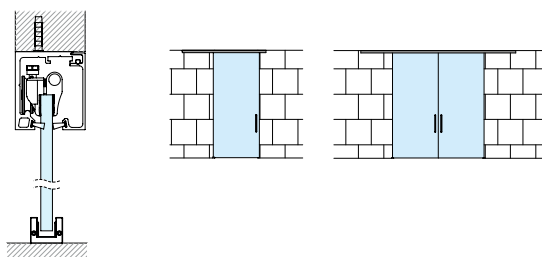

SCORREVOLE A PARETE

Sliding on Wall

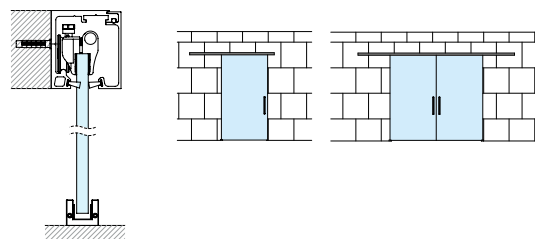

SCORREVOLE SU VETRO FISSO

Sliding on Sidelight

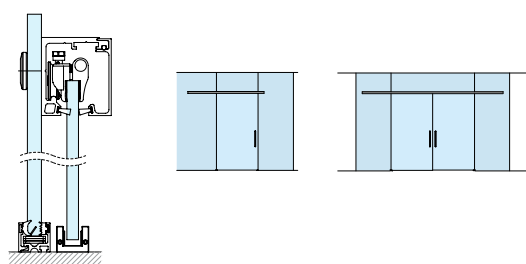

SCORREVOLE A SOFFITTO CON FISSO

Sliding on Ceiling with Sidelight

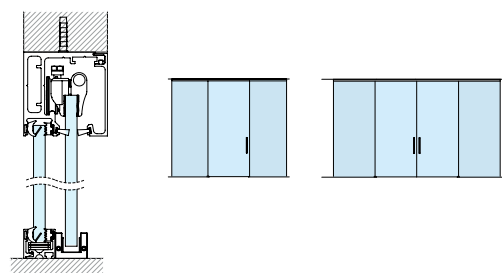

SCORREVOLE A FALSO SOFFITTO

Sliding on False Ceiling

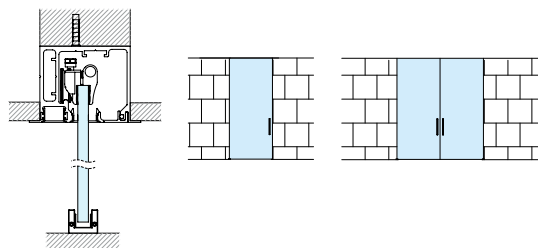

SCORREVOLE A FALSO SOFFITTO CON FISSO

Sliding on False Ceiling with Sidelight

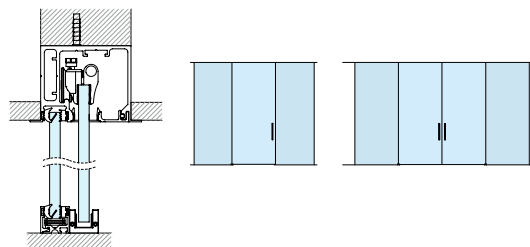

FLUIDO+ 150 PORTE IN VETRO - GLASS DOORS

Caratteristiche Tecniche Profili - Profiles Technical Characteristics

SCORREVOLE A SOFFITTO

Sliding on Ceiling

67 x 60 mm

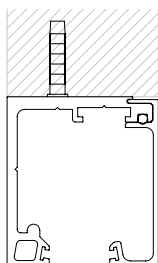

SCORREVOLE A PARETE

Sliding on Wall

67 x 60 mm

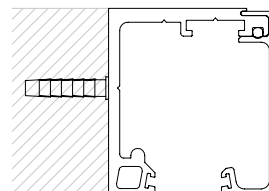

SCORREVOLE SU VETRO FISSO

Sliding on Sidelight

67 x 60 mm

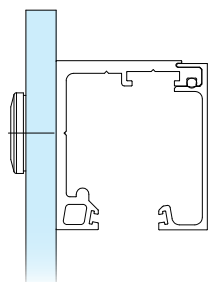

SCORREVOLE A SOFFITTO CON FISSO

Sliding on Ceiling with Sidelight

72 x 72 mm

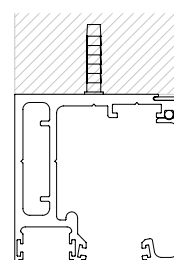

SCORREVOLE A FALSO SOFFITTO

Sliding on False Ceiling

85,4 x 72 mm

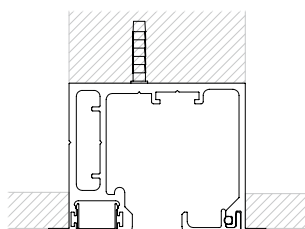

SCORREVOLE A FALSO SOFFITTO CON FISSO

Sliding on False Ceiling with Sidelight

85,4 x 72 mm

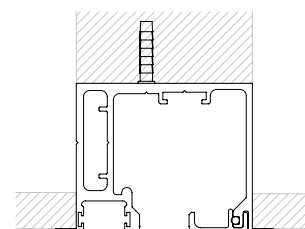

FLUIDO+ 150 PORTE IN LEGNO - WOODEN DOORS

Soluzioni - Solutions

SCORREVOLE A SOFFITTO - PORTA IN LEGNO

Sliding on Ceiling - Wooden Door

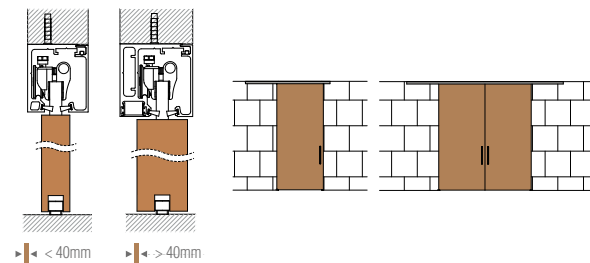

SCORREVOLE A PARETE - PORTA IN LEGNO

Sliding on Wall - Wooden Door

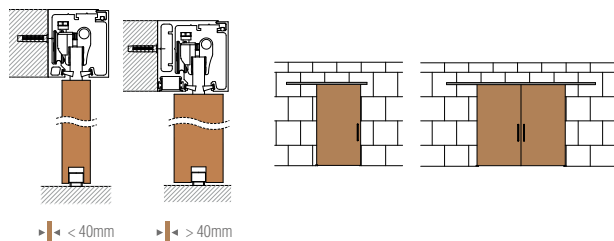

SCORREVOLE A SOFFITTO - PORTA IN LEGNO CON FISSO

Sliding on Ceiling - Wooden Door with Sidelight

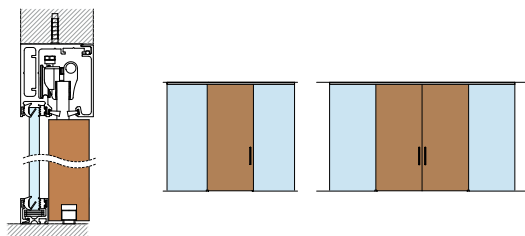

FLUIDO+ 150 PORTE IN LEGNO - WOODEN DOORS

Caratteristiche Tecniche Profili - Profiles Technical Characteristics

SCORREVOLE A SOFFITTO - PORTA IN LEGNO

Sliding on Ceiling - Wooden Door

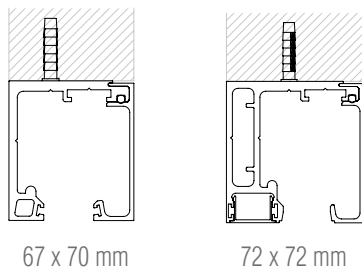

SCORREVOLE A PARETE - PORTA IN LEGNO

Sliding on Wall - Wooden Door

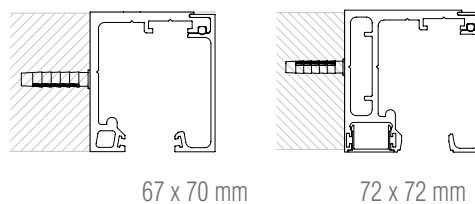





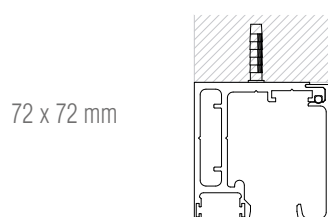











SCORREVOLE A SOFFITTO - PORTA IN LEGNO CON FISSO

Sliding on Ceiling - Wooden Door with Sidelight



FLUIDO+ 150 - Dettagli Tecnici

Technical details

 PORTATA Weight	150kg per porta / for door 330lbs		
 SPESSORE VETRO Glass thickness	10 ÷ 14 mm 3/8" to 9/16"		
 SPESSORE PORTA IN LEGNO Wooden door thickness	28 ÷ 50 mm 1 1/8" to 1 15/16"		
 REGOLAZIONE IN ALTEZZA Height adjustment	6 mm 1/4"		
 DISTANZA A PARETE Wall distance	22 mm 7/8"		
 DISTANZA TRA ANTA E VETRO FISSO Distance between door and sidelight	15.4 ÷ 17.4 mm 5/8" to 11/16"		
 INSTALLAZIONE A VETRO Glass installation	✓		
 INSTALLAZIONE A FALSO SOFFITTO False ceiling installation	✓		
 INSTALLAZIONE TRA PARETI Installation between walls	✓		
 SOFTCLOSE Soft close	Doppio / Double		
 DIMENSIONI MINIME (doppio Softclose) Minimum dimensions (double soft close)	1014 mm 39 3/4"		
 ANTISHOCK Antishock	Doppio / Double		
 DIMENSIONI MINIME (doppio antishock) Minimum dimensions (double antishock)	800 mm 31 1/2"		
 RETAINER MECCANICO Mechanical retainer	Doppio / Double		
 DIMENSIONI MINIME (doppio Retainer) Minimum dimensions (double Retainer)	800 mm 31 1/2"		
 FINITURE Finishes	02 Ossidato naturale Natural oxidized	05 Ossidato nero Black oxidized	13 PVD simil inox similar PVD stainless steel



**CERTIFICAZIONE DURABILITÀ
CICLI CORROSIONE**
Durability certification
Corrosion cycles

DURABILITÀ (100.000 Cicli)
Durability (100.000 Cycles)

PESO DELLA PORTA (da 101 a 330 kg)
Door mass (from 101 up to 330 kg)

SICUREZZA (Grado 1 per tutti gli scorrevoli)
Safety (All sliding must be grade 1)

RESISTENZA ALLA CORROSIONE (Alta resistenza)
Corrosion resistance (High resistance)

CATEGORIA DELLA PORTA (Porta scorrevole)
Category of door (Sliding door)

FRIZIONE INIZIALE VALORE MASSIMO CONSENTITO (4% della massa)
Initial friction maximum permitted value (4% of the mass)

according to

EN1527

- 6 3 - 1 3 - 1 3

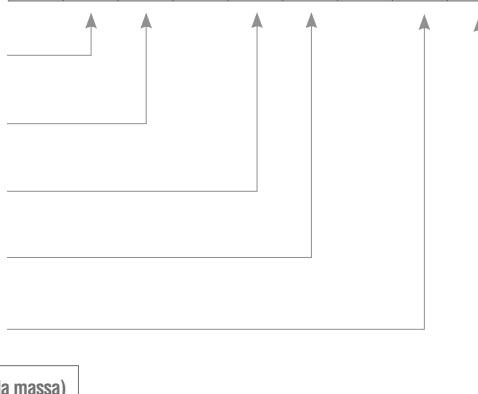

FLUIDO+ 150

scorrevole a soffitto
sliding on ceiling

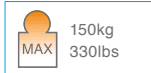
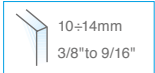

- Profili per scorrevole
- fissaggio a soffitto/parete.
- Perfil para sistema corredero
- fijación a techo/pared.
- Profiles for sliders
- fixed on ceiling/wall.
- Schiebesystem Fluido
- Befestigung an der Decke/Wand.
- Profils pour coulissants
- fixation au plafond/mur.

LUNGHEZZE PROFILI - LENGTH OF PROFILES

- B150EK00/2 (2 mt)
- B150EK00/3 (3 mt)
- B150EK00/3.2 (3.2 mt)
- B150EK00/4 (4 mt)
- B150EK00/6 (6 mt)

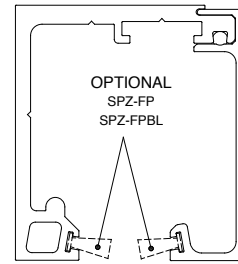

OPTIONAL

FINITURE / COLORS: 02-13

FINITURA / COLOR: 05

guarnizione a spazzola	SPZ-FP/4 (4mt)	SPZ-FPBL/4 (4mt)
	SPZ-FP/6 (6mt)	SPZ-FPBL/6 (6mt)
brush seal	SPZ-FP/6.4 (6.4mt)	SPZ-FPBL/6.4 (6.4mt)
	SPZ-FP/8 (8mt)	SPZ-FPBL/8 (8mt)
	SPZ-FP/12 (12mt)	SPZ-FPBL/12 (12mt)

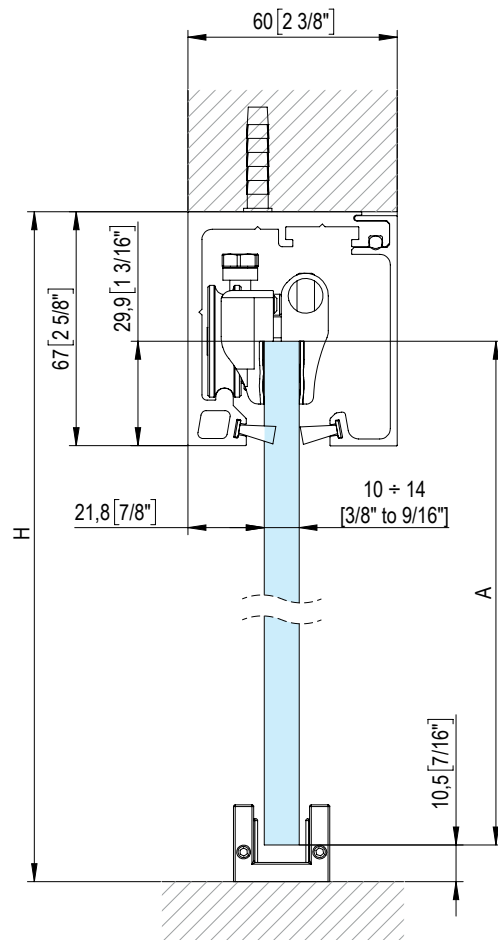
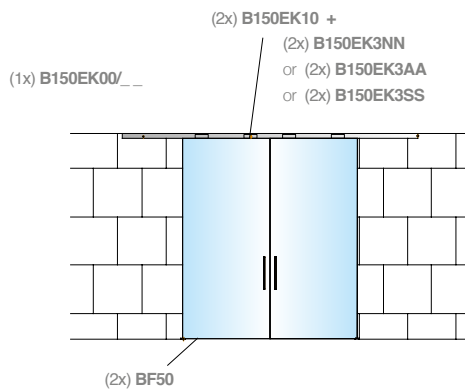
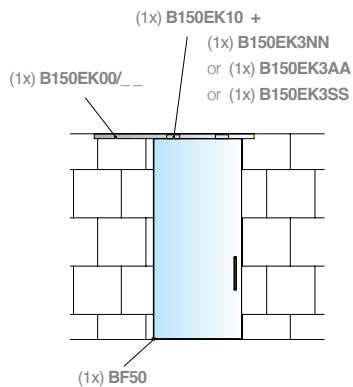

$$A = H - 48$$

$$[A = H - 1 \frac{7}{8}"]$$

L'installazione del Fluido 70, 110 e 150 non necessita di forature sul vetro. La instalación del "Fluido 70, 110 y 150" no necesita agujeros en el cristal. The installation of Fluido 70, 110 and 150 does not need holes on the glass. Die Systeme Fluido 70, 110 und 150 benötigen keine Glasbearbeitung. L'installation des coulissants Fluido 70, 110 et 150 ne requiert pas de perçage du verre.

FLUIDO+ 150

scorrevole a parete
sliding on wall

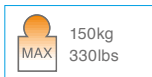
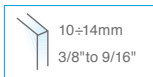

- Profili per scorrevole
- fissaggio a soffitto/parete.
- Perfil para sistema corredero
- fijación a techo/pared.
- Profiles for sliders
- fixed on ceiling/wall.
- Schiebesystem Fluido
- Befestigung an der Decke/Wand.
- Profils pour coulissants
- fixation au plafond/mur.

LUNGHEZZE PROFILI - LENGTH OF PROFILES

- B150EK00/2 (2 mt)
- B150EK00/3 (3 mt)
- B150EK00/3.2 (3.2 mt)
- B150EK00/4 (4 mt)
- B150EK00/6 (6 mt)

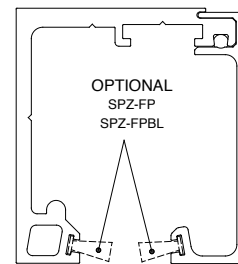

OPTIONAL

FINITURE / COLORS: 02-13

FINITURA / COLOR: 05

guarnizione a spazzola	SPZ-FP/4 (4mt)	SPZ-FPBL/4 (4mt)
	SPZ-FP/6 (6mt)	SPZ-FPBL/6 (6mt)
brush seal	SPZ-FP/6.4 (6.4mt)	SPZ-FPBL/6.4 (6.4mt)
	SPZ-FP/8 (8mt)	SPZ-FPBL/8 (8mt)
	SPZ-FP/12 (12mt)	SPZ-FPBL/12 (12mt)

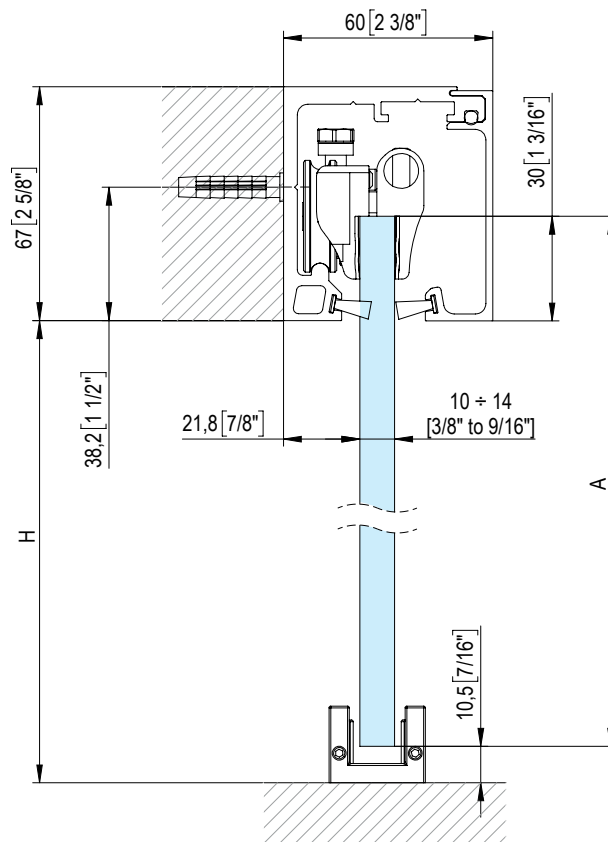
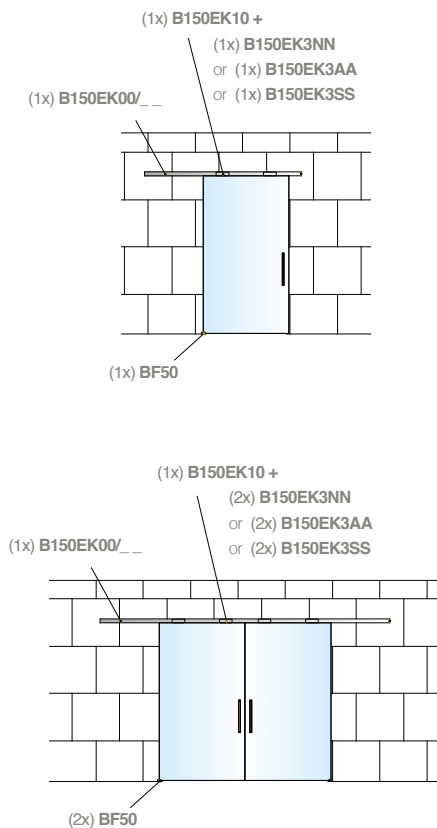

$$A = H + 19$$

$$[A = H + 3/4"]$$

L'installazione del Fluido 70, 110 e 150 non necessita di forature sul vetro. La instalación del "Fluido 70, 110 y 150" no necesita hojas en el cristal. The installation of Fluido 70, 110 and 150 does not need holes on the glass. Die Systeme Fluido 70, 110 und 150 benötigen keine Glasbearbeitung. L'installation des coulissants Fluido 70, 110 et 150 ne requiert pas de perçage du verre.

FLUIDO+ 150

scorrevole su vetro fisso
sliding on sidelight

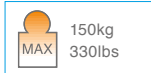
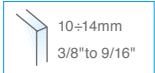

- Profili per scorrevole
- fissaggio a soffitto/parete.
- Perfil para sistema corredero
- fijación a techo/pared.
- Profiles for sliders
- fixed on ceiling/wall.
- Schiebesystem Fluido
- Befestigung an der Decke/Wand.
- Profils pour coulissants
- fixation au plafond/mur.

LUNGHEZZE PROFILI - LENGTH OF PROFILES

- B150EK00/2 (2 mt)
- B150EK00/3 (3 mt)
- B150EK00/3.2 (3.2 mt)
- B150EK00/4 (4 mt)
- B150EK00/6 (6 mt)

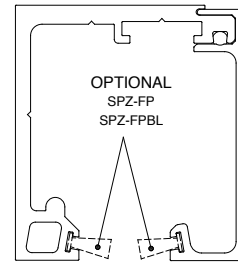

OPTIONAL

FINITURE / COLORS: 02-13

FINITURA / COLOR: 05

guarnizione a spazzola	SPZ-FP/4 (4mt)	SPZ-FPBL/4 (4mt)
brush seal	SPZ-FP/6 (6mt)	SPZ-FPBL/6 (6mt)
	SPZ-FP/6.4 (6.4mt)	SPZ-FPBL/6.4 (6.4mt)
	SPZ-FP/8 (8mt)	SPZ-FPBL/8 (8mt)
	SPZ-FP/12 (12mt)	SPZ-FPBL/12 (12mt)

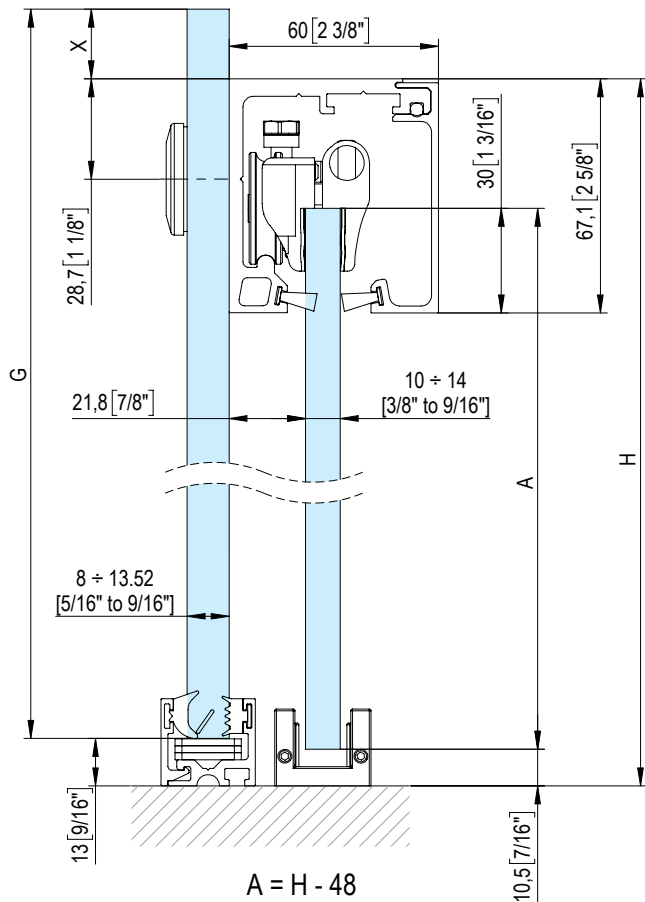
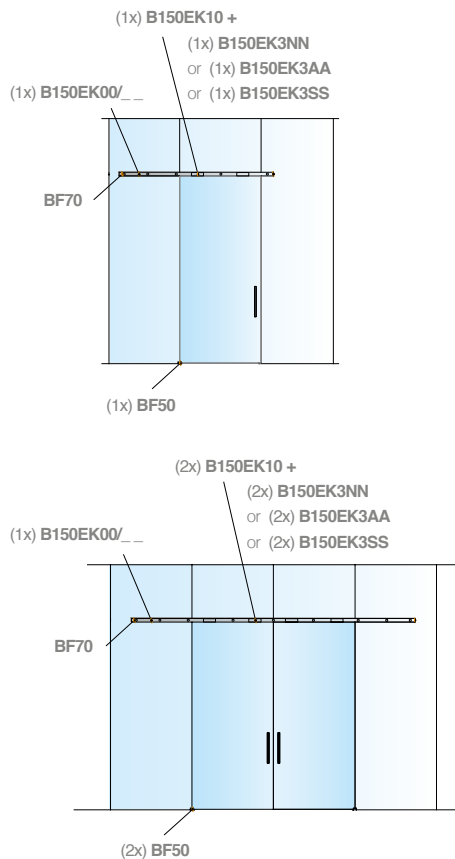

$$A = H - 48$$

$$[A = H - 1 7/8"]$$

$$G = H + X - 13$$

$$[A = H + X - 1/2"]$$

NON INCLUSI - NOT INCLUDED

P20EJ0810/6

P20EJ1113/6

P20E29/58



Vedere scheda catalogo P20E nella sezione PARTIZIONI
See P20E technical sheet in PARTITIONING section

L'installazione del Fluido 70, 110 e 150 non necessita di forature sul vetro. La instalación del "Fluido 70, 110 y 150" no necesita agujeros en el cristal. The installation of Fluido 70, 110 and 150 does not need holes on the glass. Die Systeme Fluido 70, 110 und 150 benötigen keine Glasbearbeitung. L'installation des coulissants Fluido 70, 110 et 150 ne requiert pas de perçage du verre.

FLUIDO+ 150

scorrevole a soffitto con fisso
sliding on ceiling with sidelight

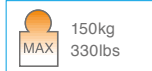
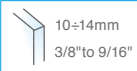

- Profili per scorrevole
- fissaggio a soffitto con vetro fisso.
- Perfil para sistema corredero
- fijación a techo con vidrio fijo.
- Profiles for sliders
- fixed on ceiling with fixed glass.
- Schiebeseystem Fluido
- Befestigung an Decke mit Seitenteilen aus Glas.
- Profils pour coulissant
- fixation au plafond avec verre fixe.

LUNGHEZZE PROFILI - LENGTH OF PROFILES

- B150EK01/2 (2 mt)
- B150EK01/3 (3 mt)
- B150EK01/3.2 (3.2 mt)
- B150EK01/4 (4 mt)
- B150EK01/6 (6 mt)

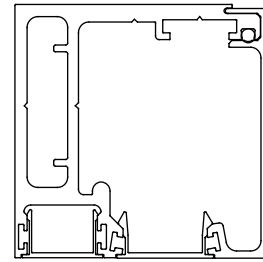
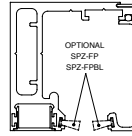

OPTIONAL

guarnizione a spazzola
brush seal

FINITURE / COLORS: 02-13

- SPZ-FP/4 (4mt)
- SPZ-FP/6 (6mt)
- SPZ-FP/6.4 (6.4mt)
- SPZ-FP/8 (8mt)
- SPZ-FP/12 (12mt)

FINITURA / COLOR: 05

- SPZ-FPBL/4 (4mt)
- SPZ-FPBL/6 (6mt)
- SPZ-FPBL/6.4 (6.4mt)
- SPZ-FPBL/8 (8mt)
- SPZ-FPBL/12 (12mt)

- B150EP45/2 (2mt)
- B150EP45/3 (3mt)
- B150EP45/3.2 (3.2mt)
- B0150EP45/4 (4mt)
- B150EP45/6 (6mt)

- B150EP46/2 (2mt)
- B150EP46/3 (3mt)
- B0150EP46/3.2 (3.2mt)
- B150EP46/4 (4mt)
- B150EP46/6 (6mt)

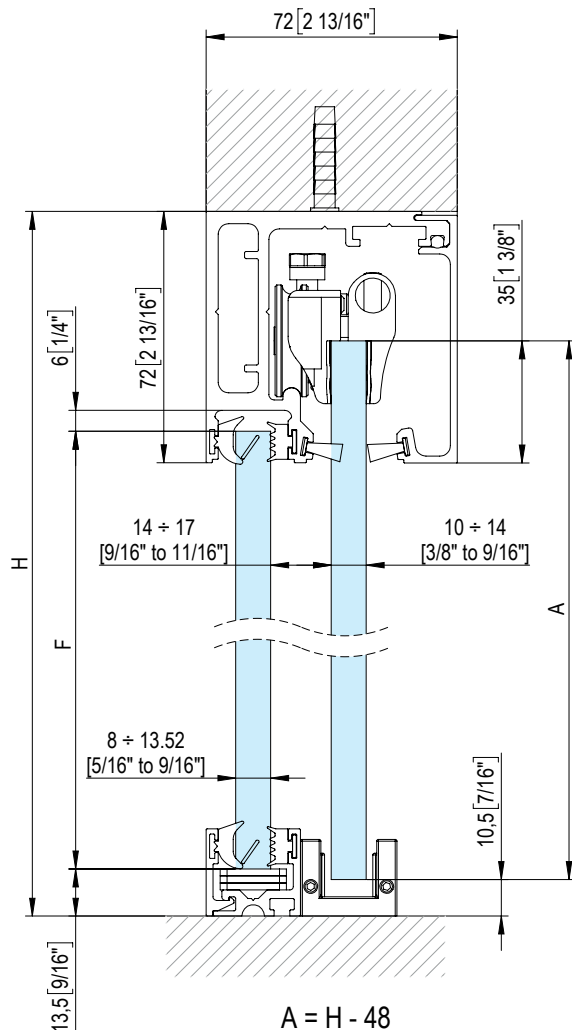
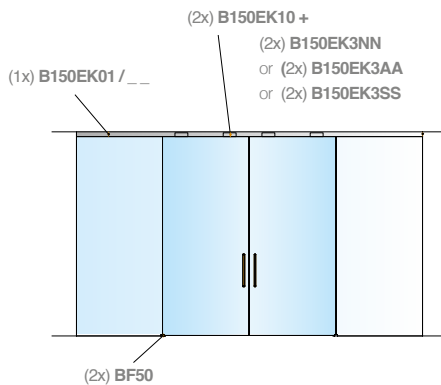
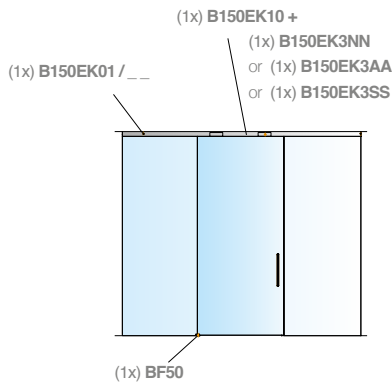

$$A = H - 48$$

$$[A = H - 1 \frac{7}{8}"]$$

$$F = H - 77$$

$$[F = H - 3 \frac{1}{16}"]$$

NON INCLUSI - NOT INCLUDED

P20EJ0810/6



P20EJ1113/6



P20E29/58



Vedere scheda catalogo P20E nella sezione PARTIZIONI
See P20E technical sheet in PARTITIONING section

L'installazione dei Fluido 70, 110 e 150 non necessita di forature sul vetro. La instalación del "Fluido 70, 110 y 150" no necesita hojas en el cristal. The installation of Fluido 70, 110 and 150 does not need holes on the glass. Die Systeme Fluido 70, 110 und 150 benötigen keine Glasbearbeitung. L'installation des coulissants Fluido 70, 110 et 150 ne requiert pas de perçage du verre.

FLUIDO+ 150

scorrevole a falso soffitto
sliding on false ceiling

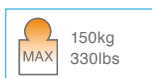
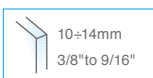

- Profili per scorrevole
- fissaggio a falso soffitto.
- Perfil para sistema corredero
- fijación a cielo falso.
- Kit profiles for sliders
- fixed on false ceiling.
- Profil für Schiebesystem
- Befestigung an abgehängter Decke.
- Profils pour portes coulissantes
- fixation sur faux-plafond.

! Disponibile da Marzo 2021
Available from March 2021

LUNGHEZZE PROFILI - LENGTH OF PROFILES

B150EK02/2 (2 mt)

B150EK02/3 (3 mt)

B150EK02/3.2 (3.2 mt)

B150EK02/4 (4 mt)

B150EK02/6 (6 mt)

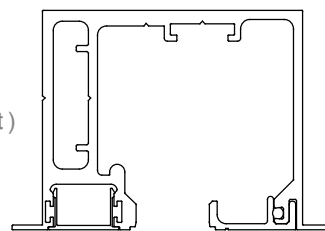

OPTIONAL

B150EP45/2 (2mt)

B150EP45/3 (3mt)

B150EP45/3.2 (3.2mt)

B0150EP45/4 (4mt)

B150EP45/6 (6mt)

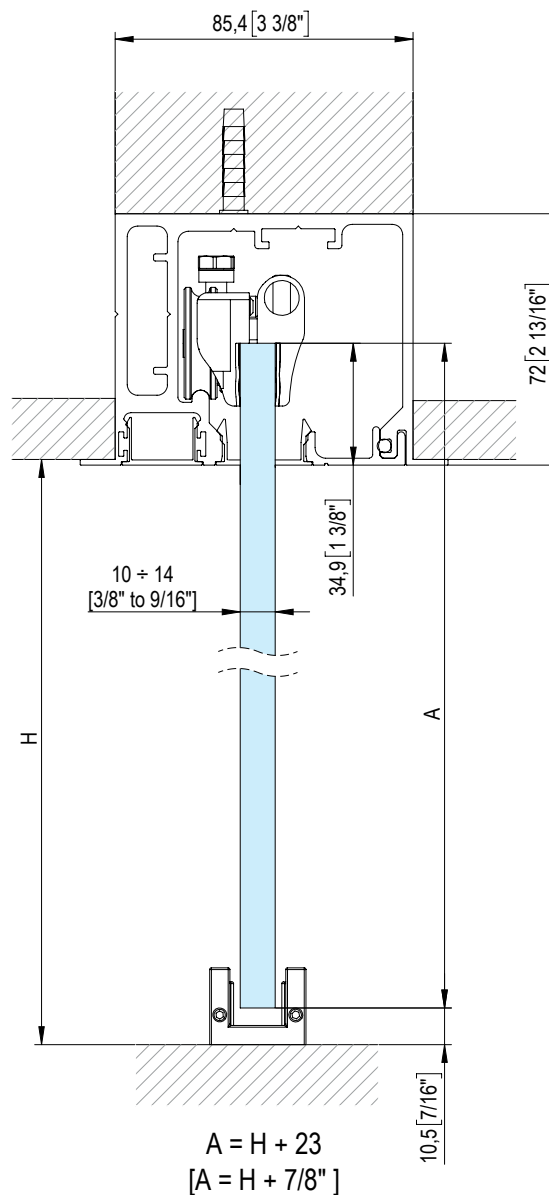
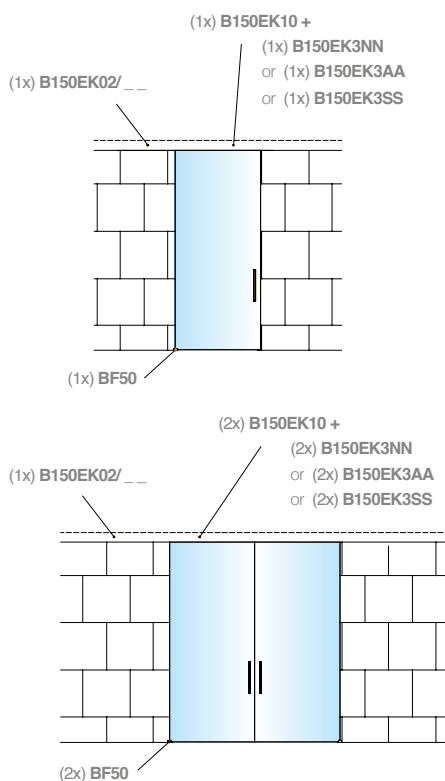

L'installazione del Fluido 70, 110 e 150 non necessita di forature sul vetro. La instalación del "Fluido 70, 110 y 150" no necesita agujeros en el cristal. The installation of Fluido 70, 110 and 150 does not need holes on the glass. Die Systeme Fluido 70, 110 und 150 benötigen keine Glasbearbeitung. L'installation des coulissants Fluido 70, 110 et 150 ne requiert pas de perçage du verre.

FLUIDO+ 150

scorrevole a falso soffitto con fisso
sliding on false ceiling with sidelight

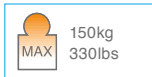
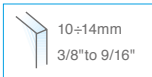

- Profili per scorrevole
- fissaggio a falso soffitto con vetro fisso.
- Perfil para sistema correrer
- fijación a cielo falso con vidrio fijo.
- Profiles for sliders
- fixed on false ceiling with fixed glass.
- Profil für Schiebeseystem - Befestigung an abgehängter Decke mit Glasseitenteil.
- Profils pour coulissants
- fixation faux-plafond avec verre fixe.

! Disponibile da Marzo 2021
Available from March 2021

LUNGHEZZE PROFILI - LENGTH OF PROFILES

B150EK02/2 (2 mt)

B150EK02/3 (3 mt)

B150EK02/3.2 (3.2 mt)

B150EK02/4 (4 mt)

B150EK02/6 (6 mt)

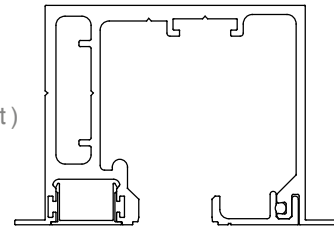

OPTIONAL

- B150EP45/2 (2mt)
- B150EP45/3 (3mt)
- B150EP45/3.2 (3.2mt)
- B0150EP45/4 (4mt)
- B150EP45/6 (6mt)

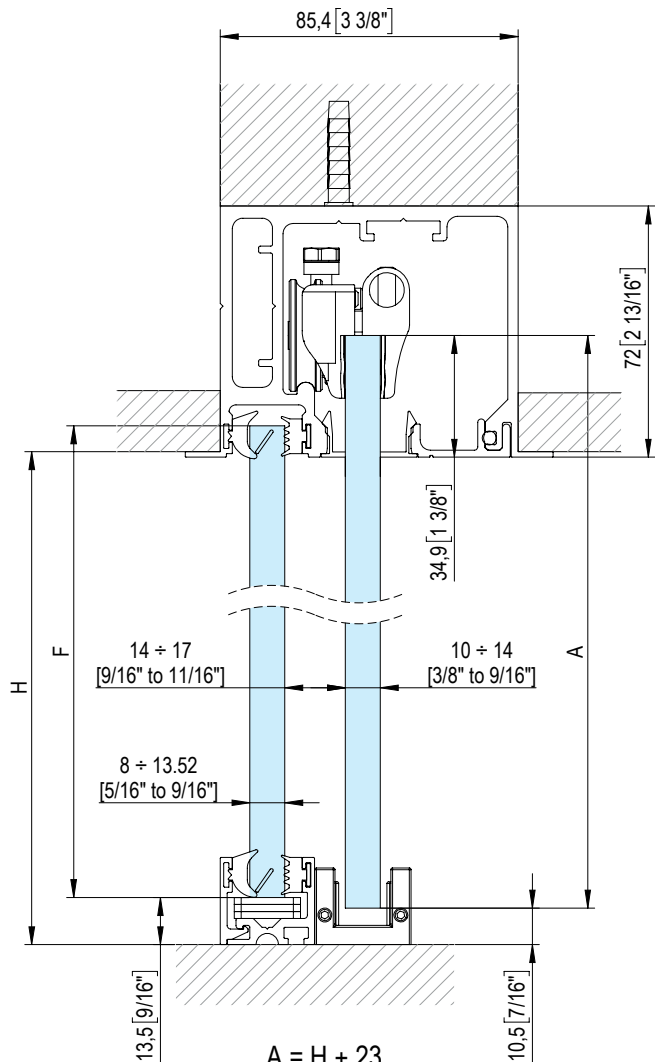
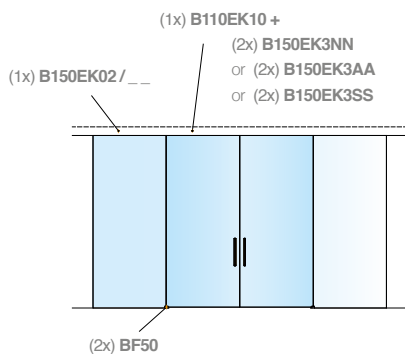
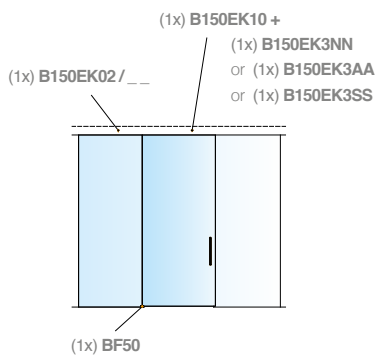

NON INCLUSI - NOT INCLUDED

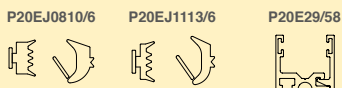

Vedere scheda catalogo P20E nella sezione PARTIZIONI
See P20E technical sheet in PARTITIONING section

L'installazione dei Fluido 70, 110 e 150 non necessita di forature sul vetro. La instalación del "Fluido 70, 110 y 150" no necesita agujeros en el cristal. The installation of Fluido 70, 110 and 150 does not need holes on the glass. Die Systeme Fluido 70, 110 und 150 benötigen keine Glasbearbeitung. L'installation des coulissants Fluido 70, 110 et 150 ne requiert pas de perçage du verre.

FLUIDO+ 150



scorrevole a soffitto - porta in legno
sliding on ceiling - wooden door

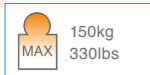

- Profili per scorrevole in legno
- fissaggio a soffitto.
- Perfil para sistema corredero - puertas de madera
- fijación a techo.
- Profiles for sliders - wooden doors
- fixed on ceiling.
- Schiebesystem Fluido - Holztüren
- Befestigung an der Decke.
- Profils pour coulissants - Portes en bois
- fixation au plafond.

LUNGHEZZE PROFILI - LENGTH OF PROFILES

B150EK00/2 (2 mt)

B150EK00/3 (3 mt)

B150EK00/3.2 (3.2 mt)

B150EK00/4 (4mt)

B150EK00/6 (6mt)

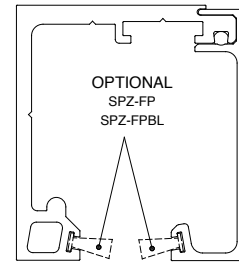

OPTIONAL

FINITURE / COLORS: 02-13

FINITURA / COLOR: 05

guarnizione
a spazzola
brush seal

SPZ-FP/4 (4mt)
SPZ-FP/6 (6mt)
SPZ-FP/6.4 (6.4mt)
SPZ-FP/8 (8mt)
SPZ-FP/12 (12mt)

SPZ-FPBL/4 (4mt)
SPZ-FPBL/6 (6mt)
SPZ-FPBL/6.4 (6.4mt)
SPZ-FPBL/8 (8mt)
SPZ-FPBL/12 (12mt)

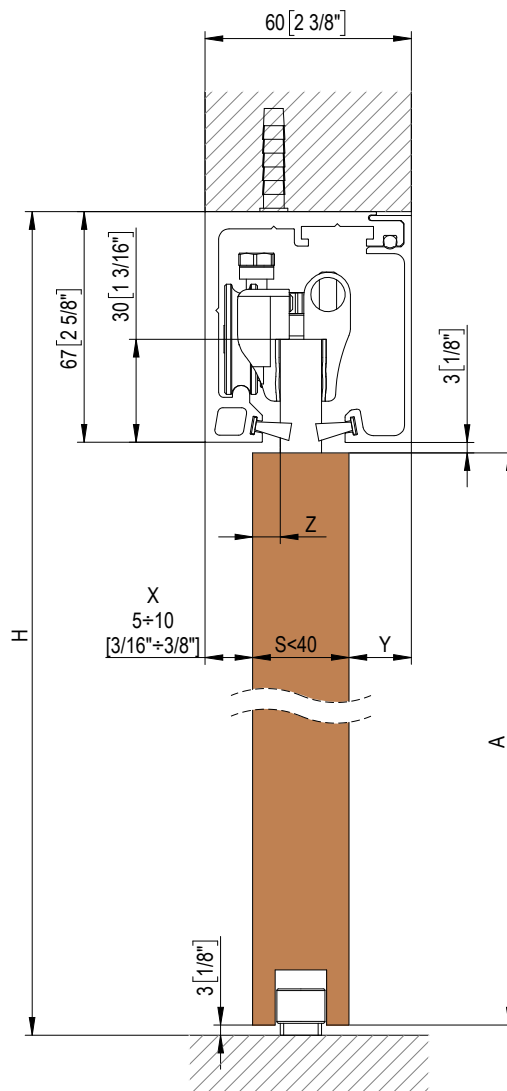
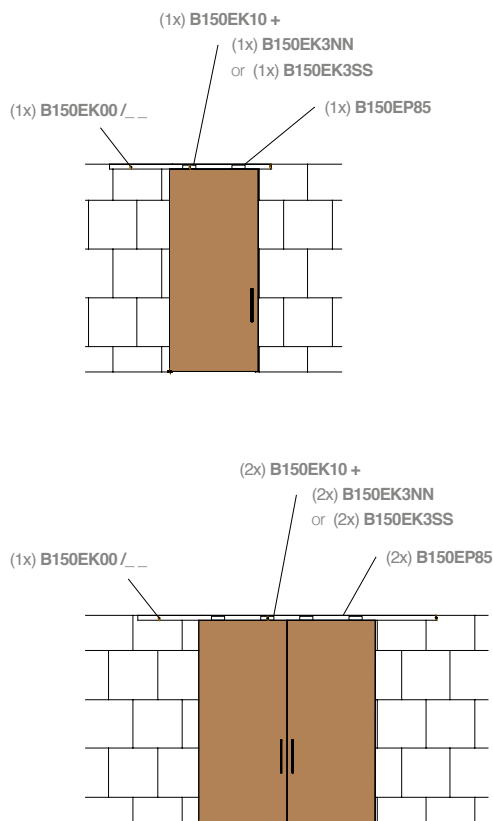

$$A = H - 73$$

$$[A = H - 2 7/8"]$$

$$Y = 60 - X - S$$

$$[Y = [2 3/8" - X - S]$$

$$Z = 22 - X$$

$$[Z = 7/8" - X]$$

FLUIDO+ 150



scorrevole a soffitto - porta in legno
sliding on ceiling - wooden door



- Profili per scorrevole in legno - fissaggio a soffitto.
- Perfil para sistema corredero puertas de madera - fijación a techo.
- Profiles for sliders - wooden doors - fixed on ceiling.
- Schiebeseystem Fluido - Holztüren - Befestigung an der Decke.
- Profils pour coulissants - Portes en bois - fixation au plafond.

LUNGHEZZE PROFILI - LENGTH OF PROFILES

- B150EK01/2 (2 mt)
- B150EK01/3 (3 mt)
- B150EK01/3.2 (3.2 mt)
- B150EK01/4 (4 mt)
- B150EK01/6 (6 mt)

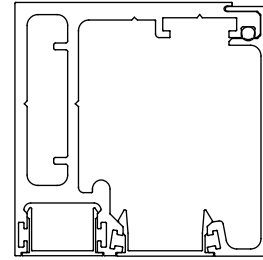
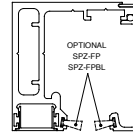

OPTIONAL

guarnizione a spazzola
brush seal

FINITURE / COLORS: 02-13

- SPZ-FP/4 (4mt)
- SPZ-FP/6 (6mt)
- SPZ-FP/6.4 (6.4mt)
- SPZ-FP/8 (8mt)
- SPZ-FP/12 (12mt)

FINITURA / COLOR: 05

- SPZ-FPBL/4 (4mt)
- SPZ-FPBL/6 (6mt)
- SPZ-FPBL/6.4 (6.4mt)
- SPZ-FPBL/8 (8mt)
- SPZ-FPBL/12 (12mt)

- B150EP45/2 (2mt)
- B150EP45/3 (3mt)
- B150EP45/3.2 (3.2mt)
- B0150EP45/4 (4mt)
- B150EP45/6 (6mt)

- B150EP46/2 (2mt)
- B150EP46/3 (3mt)
- B0150EP46/3.2 (3.2mt)
- B150EP46/4 (4mt)
- B150EP46/6 (6mt)

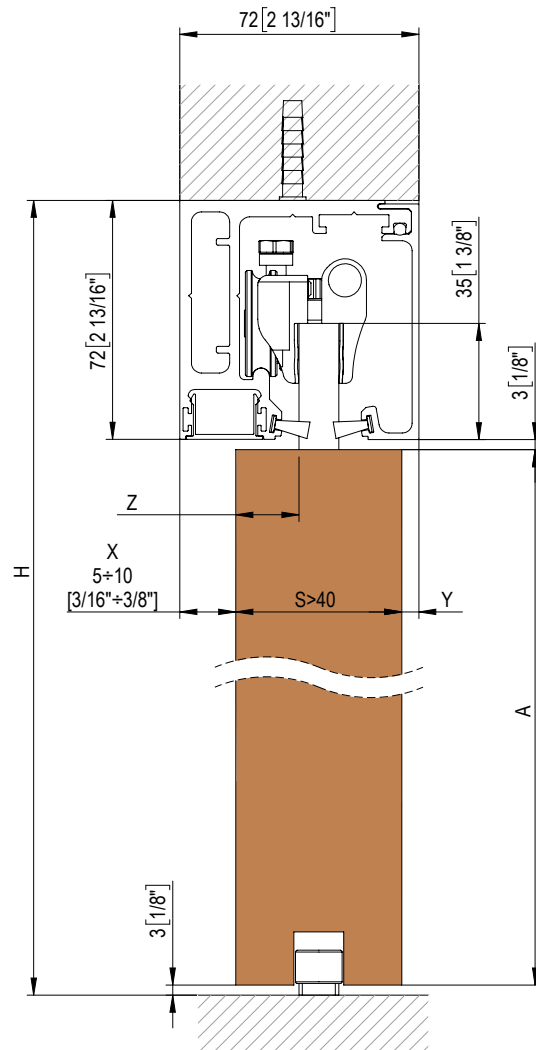
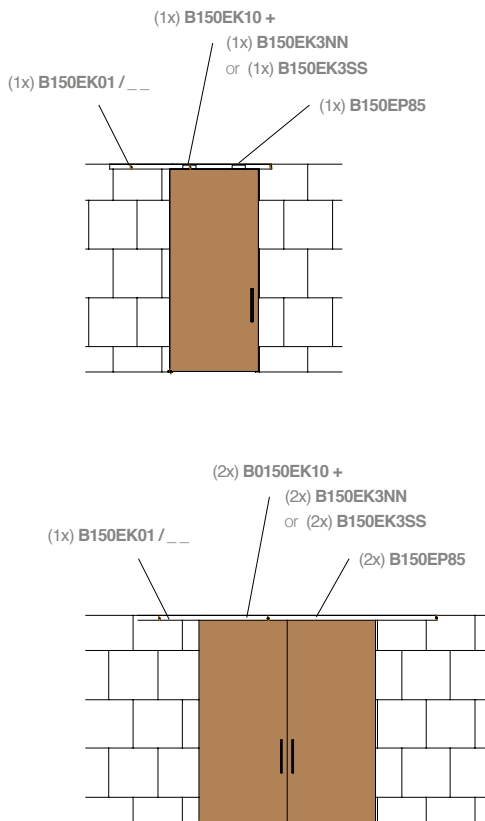

$$A = H - 78$$

$$[A = H - 3 \frac{1}{16}"]$$

$$Y = 72 - X - S$$

$$[Y = [2 \frac{13}{16} - X - S]$$

$$Z = 36 - X$$

FLUIDO+ 150

 **< 40 mm**

scorrevole a parete - porta in legno
sliding on wall - wooden door

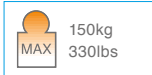

- Profili per scorrevole in legno
- fissaggio a parete.
- Perfil para sistema corredero - puertas de madera
- fijación a pared.
- Profiles for sliders - wooden doors
- fixed on wall.
- Schiebesystem Fluido - Holztüren
- Befestigung an der Wand.
- Profils pour coulissants - Portes en bois
- fixation au mur.

LUNGHEZZE PROFILI - LENGTH OF PROFILES

B150EK00/2 (2 mt)

B150EK00/3 (3 mt)

B150EK00/3.2 (3.2 mt)

B150EK00/4 (4mt)

B150EK00/6 (6mt)

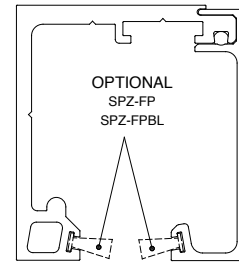

OPTIONAL

FINITURE / COLORS: 02-13

FINITURA / COLOR: 05

guarnizione
a spazzola
brush seal

SPZ-FP/4 (4mt)
SPZ-FP/6 (6mt)
SPZ-FP/6.4 (6.4mt)
SPZ-FP/8 (8mt)
SPZ-FP/12 (12mt)

SPZ-FPBL/4 (4mt)
SPZ-FPBL/6 (6mt)
SPZ-FPBL/6.4 (6.4mt)
SPZ-FPBL/8 (8mt)
SPZ-FPBL/12 (12mt)

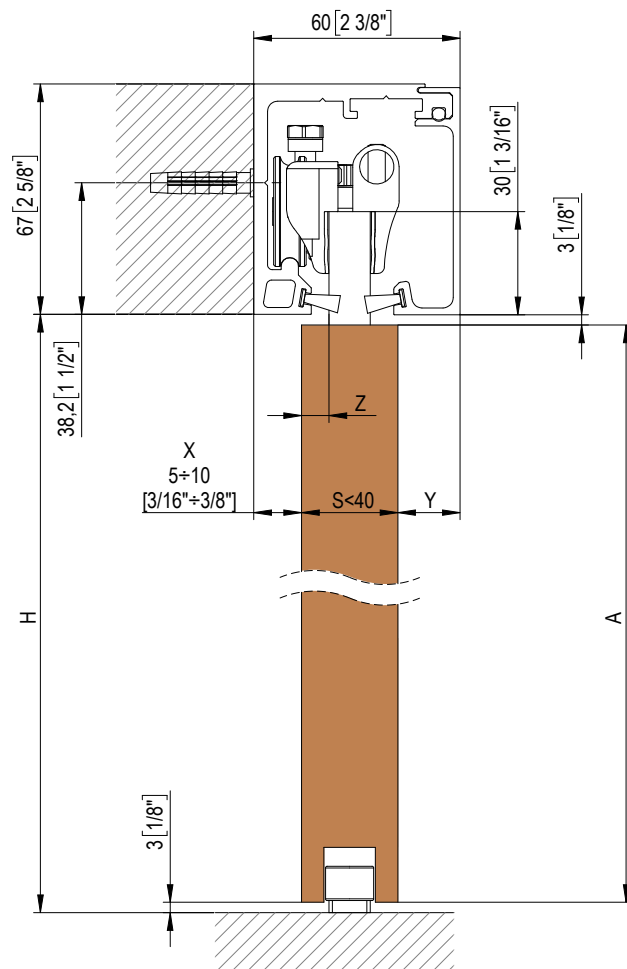
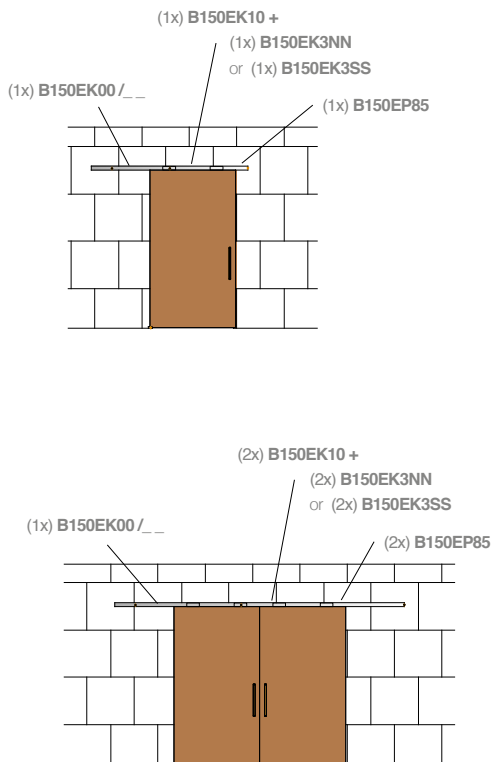

$$\begin{aligned}
 A &= H - 6 \\
 [A &= H - 1/4"] \\
 Y &= 60 - X - S \\
 [Y &= [2 \ 3/8" - X - S] \\
 Z &= 22 - X \\
 [Z &= 7/8" - X]
 \end{aligned}$$

FLUIDO+ 150



scorrevole a parete - porta in legno
sliding on wall - wooden door



- Profili per scorrevole in legno - fissaggio a parete.
- Perfil para sistema corredero puertas de madera - fijación a pared.
- Profiles for sliders - wooden doors - fixed on wall.
- Schiebeseystem Fluido - Holztüren - Befestigung an der Wand.
- Profils pour coulissants - Portes en bois - fixation au mur.

LUNGHEZZE PROFILI - LENGTH OF PROFILES

- B150EK01/2 (2 mt)
- B150EK01/3 (3 mt)
- B150EK01/3.2 (3.2 mt)
- B150EK01/4 (4 mt)
- B150EK01/6 (6 mt)

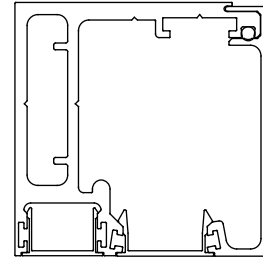
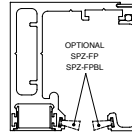

OPTIONAL

guarnizione a spazzola
brush seal

FINITURE / COLORS: 02-13

- SPZ-FP/4 (4mt)
- SPZ-FP/6 (6mt)
- SPZ-FP/6.4 (6.4mt)
- SPZ-FP/8 (8mt)
- SPZ-FP/12 (12mt)

FINITURA / COLOR: 05

- SPZ-FPBL/4 (4mt)
- SPZ-FPBL/6 (6mt)
- SPZ-FPBL/6.4 (6.4mt)
- SPZ-FPBL/8 (8mt)
- SPZ-FPBL/12 (12mt)

- B150EP45/2 (2mt)
- B150EP45/3 (3mt)
- B150EP45/3.2 (3.2mt)
- B0150EP45/4 (4mt)
- B150EP45/6 (6mt)

- B150EP46/2 (2mt)
- B150EP46/3 (3mt)
- B0150EP46/3.2 (3.2mt)
- B150EP46/4 (4mt)
- B150EP46/6 (6mt)

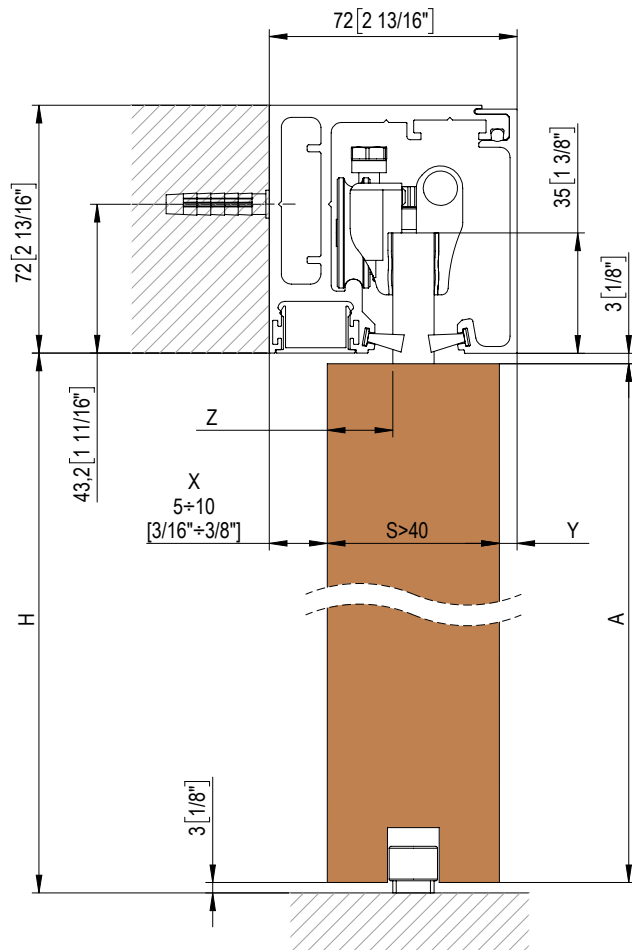
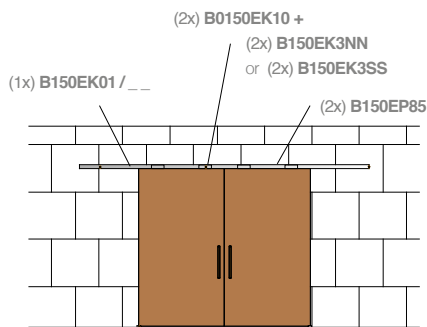
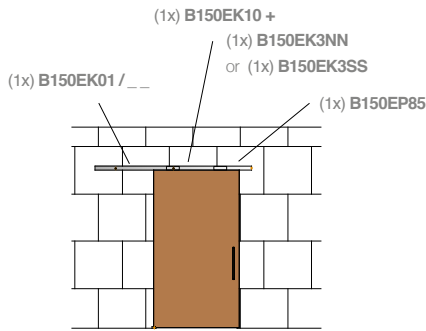

$$\begin{aligned}
 A &= H - 6 \\
 [A &= H - 1/4"] \\
 Y &= 72 - X - S \\
 [Y &= [2\ 13/16" - X - S] \\
 Z &= 36 - X \\
 [Z &= 1\ 7/16" - X]
 \end{aligned}$$

FLUIDO+ 150

scorrevole a soffitto - porta in legno con fisso
sliding on ceiling - wooden door with sidelight

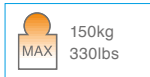

- Profili per scorrevole in legno
- fissaggio a soffitto con vetro fisso.
- Perfil para sistema corredero - puertas de madera
- fijación a techo con vidrio fijo.
- Profiles for sliders - wooden doors
- fixed on ceiling with fixed glass.
- Schiebesystem Fluido - Holztüren
- Befestigung an Decke mit Seitenteilen aus Glas.
- Profils pour coulissant - Portes en bois
- fixation au plafond avec verre fixe.

LUNGHEZZE PROFILI - LENGTH OF PROFILES

- B150EK01/2 (2 mt)
- B150EK01/3 (3 mt)
- B150EK01/3.2 (3.2 mt)
- B150EK01/4 (4 mt)
- B150EK01/6 (6 mt)

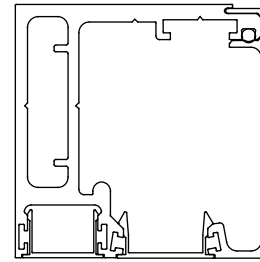
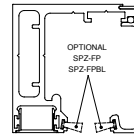

OPTIONAL

guarnizione a spazzola
brush seal

FINITURE / COLORS: 02-13

- SPZ-FP/4 (4mt)
- SPZ-FP/6 (6mt)
- SPZ-FP/6.4 (6.4mt)
- SPZ-FP/8 (8mt)
- SPZ-FP/12 (12mt)

FINITURA / COLOR: 05

- SPZ-FPBL/4 (4mt)
- SPZ-FPBL/6 (6mt)
- SPZ-FPBL/6.4 (6.4mt)
- SPZ-FPBL/8 (8mt)
- SPZ-FPBL/12 (12mt)

- B150EP45/2 (2mt)
- B150EP45/3 (3mt)
- B150EP45/3.2 (3.2mt)
- B0150EP45/4 (4mt)
- B150EP45/6 (6mt)

- B150EP46/2 (2mt)
- B150EP46/3 (3mt)
- B0150EP46/3.2 (3.2mt)
- B150EP46/4 (4mt)
- B150EP46/6 (6mt)

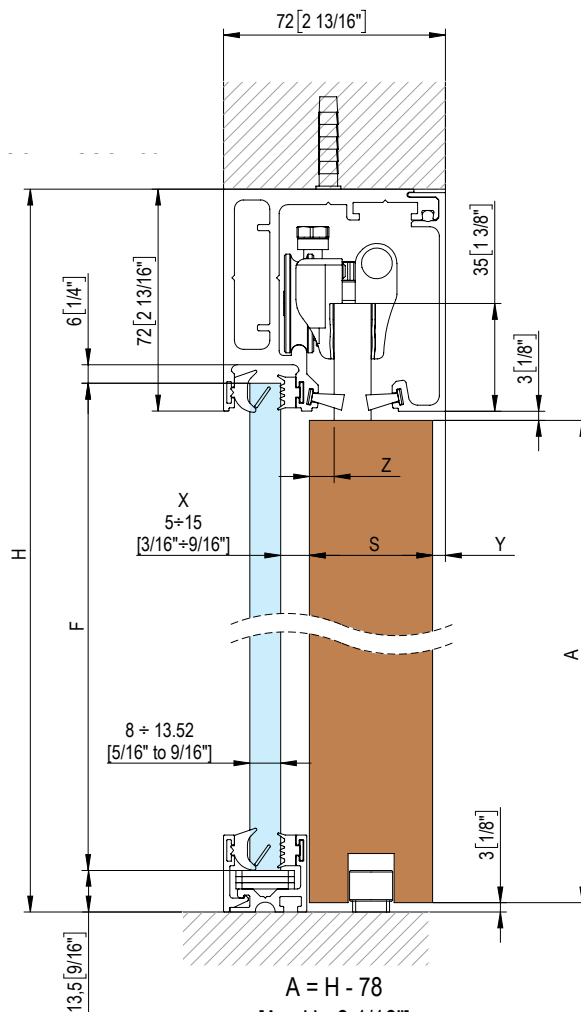
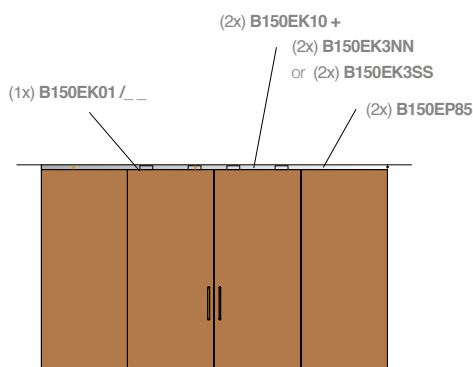
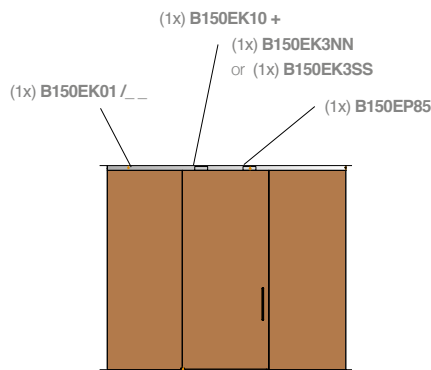

$$\begin{aligned}
 A &= H - 78 \\
 [A &= H - 3 \frac{1}{16}"] \\
 F &= H - 77 \\
 [F &= H - 3 \frac{1}{16}"] \\
 Y &= 72 - X - S \\
 [Y &= [2 \frac{13}{16} - X - S] \\
 Z &= 17 - X \\
 [Z &= 11 \frac{1}{16} - X]
 \end{aligned}$$

FLUIDO+ 150 - KIT

Components

KB150CS0/3.2

- Kit scorrevole parete/soffitto con doppio soft-close.
- Kit corredizo de pared / techo con doble Soft-close
- Sliding wall / ceiling kit with double soft-close
- Schiebewand- / Deckensatz mit doppeltem Soft-Close
- Kit mur / plafond coulissant à double Soft-Close.

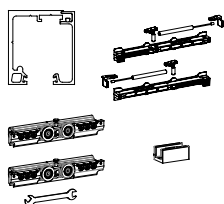

KB150SS0/3.2

- Kit scorrevole su vetro fisso con doppio soft-close.
- Kit corredizo sobre vidrio fijo con doble Soft-close
- Sliding kit on fixed glass with double soft-close
- Schiebesatz auf festem Glas mit doppeltem Soft-Close
- Kit coulissant sur verre fixe avec double Soft-Close

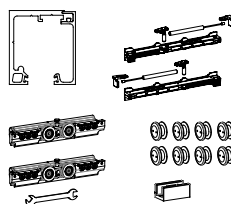

KB150FS0/3.2

- Kit scorrevole a soffitto con fisso, con doppio soft-close.
- Kit de techo corredizo fijo con doble Soft-close
- Fixed sliding ceiling kit with double soft-close
- Festes Schiebedeckenset mit doppeltem Soft-Close
- Kit plafond fixe coulissant avec à double Soft-Close

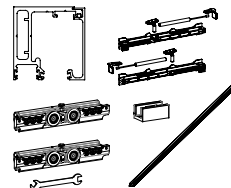

KB150CM0/3.2

- Kit scorrevole parete/soffitto con retainer e stop meccanico.
- Kit corredizo de techo / pared con retenedor y tope mecánico
- Sliding wall / ceiling kit with retainer and mechanical stop
- Schiebewand- / Deckensatz mit Halterung und mechanischem Anschlag
- Kit mur / plafond coulissant avec arrêtoir et butée mécanique

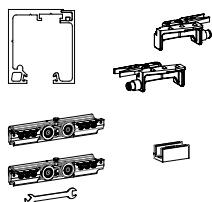

KB150SM0/3.2

- Kit scorrevole su vetro fisso con retainer e stop meccanico.
- Kit corredizo sobre vidrio fijo con retenedor y tope mecánico
- Sliding kit on fixed glass with retainer and mechanical stop
- Schiebesatz auf festem Glas mit Halter und mechanischem Anschlag
- Kit coulissant sur verre fixe avec arrêtoir et butée mécanique

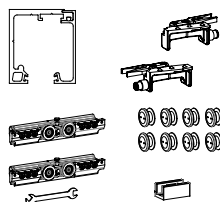

KB150FM0/3.2

- Kit scorrevole a soffitto con fisso, con retainer e stop meccanico.
- Kit de techo corredizo fijo, con retenedor y tope mecánico.
- Sliding ceiling kit with fixed, with retainer and mechanical stop
- Schiebedeckensatz mit fester, mit Halterung und mechanischem Anschlag
- Kit plafond coulissant avec fixe, avec arrêtoir et butée mécanique

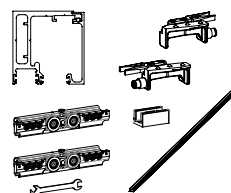

KB150CA0/3.2

- Kit scorrevole parete/soffitto con retainer e antishock.
- Kit corredizo de pared / techo con retenedor y Antishock
- Sliding wall / ceiling kit with retainer and Antishock
- KSchiebewand- / Deckensatz mit Halter und Antishock
- Kit mur / plafond coulissant avec retenue et Antishock

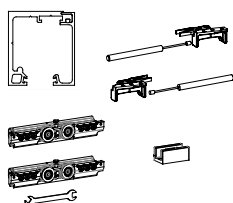

KB150SA0/3.2

- Kit scorrevole su vetro fisso con retainer e antishock.
- Kit corredizo sobre vidrio fijo con retenedor y Antishock
- Sliding kit on fixed glass with retainer and Antishock
- Schiebesatz auf festem Glas mit Halter und Antishock
- Kit coulissant sur verre fixe avec retenue et Antishock

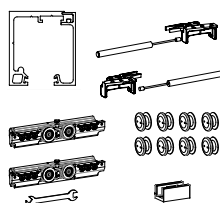

KB150FA0/3.2

- Kit scorrevole a soffitto con fisso, con retainer e antishock.
- Kit de techo corredizo con fija, con retenedor y Antishock
- Sliding ceiling kit with fixed, with retainer and Antishock
- Schiebedecken-Kit mit fester, mit Halter und Antishock
- Kit plafond coulissant avec fixe, avec retenue et Antishock

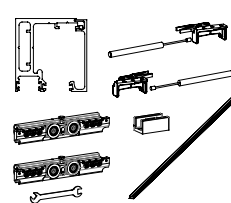

FLUIDO+ 150 - KIT

Components

B150EK10

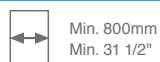

- Kit coppia pinze con chiave
- Kit par de pinzas con llave
- Kit with pair of clamps with key
- Bausatz ein Paar Zangen mit Schlüssel
- Kit paire de pinces avec clé

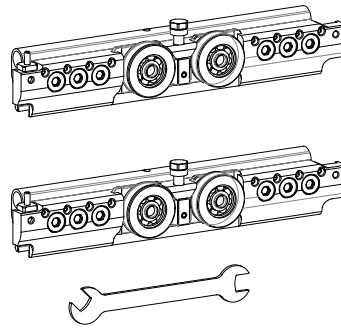

B150EK3NN

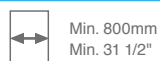

- Kit coppia Retainer. Stop meccanico
- Kit par tope mecánico
- Kit with pair of mechanical stops
- Bausatz ein Paar mechanische Stopper
- Kit paire arrêt mécanique

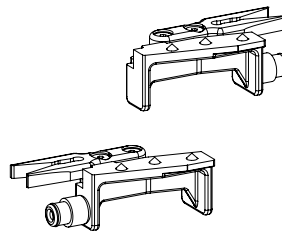

B150EK3AA

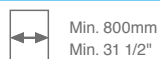

- Kit coppia Retainer + Antishock
- Kit par tope mecánico + antichoque
- Kit with pair of mechanical stops and anti-shock feature
- Bausatz ein Paar mechanische Stopper + Antishock
- Kit paire arrêt mécanique + butée antichoc

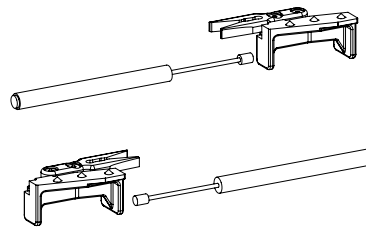

B150EK3SS



- Kit coppia Soft Close CPCS
- Kit par Soft Close CPCS
- Kit with Soft Close CPCS pair
- Bausatz ein Paar Soft Close CPCS
- Kit paire Soft Close CPCS

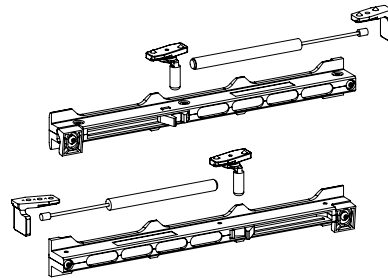

B150EP73

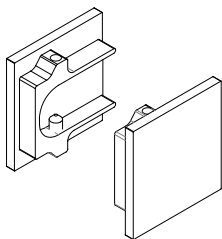

- Coppia di tappi.
- Par de tapones
- Pair of caps
- Paar Kappen
- Paire de bouchons

B150EP74

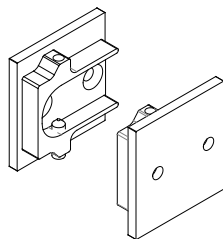

- Coppia di tappi forati.
- Par de tapones perforados
- Pair of perforated caps
- Paar Lochkappen
- Paire de bouchons perforés

B150EP75

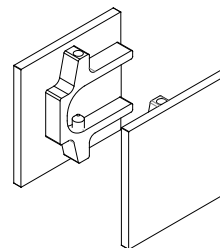

- Coppia di tappi per versione con fisso laterale.
- Par de tapones para versión con cristal fijo lateral
- Pair of caps for model with side fixed glass
- Paar Kappen für Version mit festem Seitenglas
- Paire de bouchons pour version avec vitrage fixe latéral

B150EP76

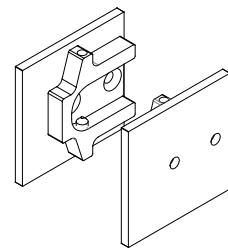

- Coppia di tappi forati per versione con fisso laterale.
- Par de tapones perforados para versión con cristal fijo lateral
- Pair of perforated caps for model with side fixed glass
- Paar Lochkappen für Version mit festem Seitenglas
- Paire de bouchons perforés pour version avec vitrage fixe latéral

FLUIDO+ 150 - COMPONENTI

Components

B150EP64

- Spessore per Velella - senza vetro fisso
Consigliato per binari oltre i 2,5m.
- Cuña para panel – sin cristal fijo
Aconsejado para perfiles de largo superior a 2,5 m
- Spacer for casing – without fixed glass
Recommended for rails longer than 2,5 m
- Distanzstück für Anlauf – ohne festes Glas.
Empfohlen für Profilen über 2,5 m
- Épaisseur pour panneau – sans vitrage fixe
Recommandé pour les profils de plus de 2,5 m



B150EP65

- Spessore per Velella - con vetro fisso
Consigliato per binari oltre i 2,5m.
- Cuña para panel – con cristal fijo
Aconsejado para perfiles de largo superior a 2,5 m
- Spacer for casing – with fixed glass
Recommended for rails longer than 2,5 m
- Distanzstück für Anlauf – mit festem Glas
Empfohlen für Profilen über 2,5 m
- Épaisseur pour panneau – avec vitrage fixe
Recommandé pour les profils de plus de 2,5 m



B150EP77

- Coppia supporti laterali
- Par de soportes laterales
- Pair of side fittings
- Paar Seitenträger
- Paire de supports latéraux

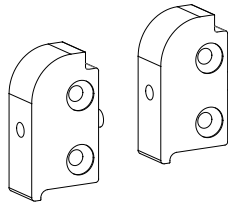

B150EP48

- Tassello di collegamento - per vetro fisso
- Pieza de unión - para cristal fijo
- Connection insert - for fixed glass
- Verbindungsdübel - für festem Glas
- Tasseau d'assemblage - pour vitrage fixe

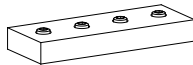

BF50

- Guida a terra.
- Guía de suelo
- Ground slide
- Bodenführung
- Guide au sol

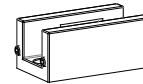

SPZ-FP

- Guarnizione a spazzola in tessuto
- Guarnición de tela
- Fabric brush seal
- Stoffbürstendichtung
- Joint de brosse en tissu



SPZ-FP

SPZ-FPBL



SPZ-FPBL

B150EP85

- Kit accessorio per porte in legno.
- Kit accesorios para puertas de madera.
- Accessory kit for wooden doors.
- Zubehörkit für Holztüren.
- Kit accessoires pour portes en bois.

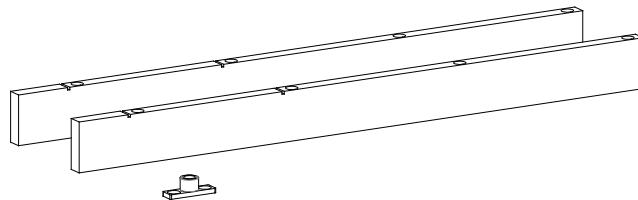

BF70

- Borchia per fissaggio barra a vetro.
- Perno de fijación de la barra al cristal
- Boss for securing glass bar
- Senkschraube zur Befestigung der Stange am Glas
- Clou de fixation de la barre à la vitre

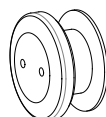

Lunghezza barra

Longitud de la barra
Bar length
Profililänge
Longueur de barre

Quantità borchie

Cantidad tornillos
Quantity of studs
Anzahl der Stifte
Quantité

2 mt	5
3,2 mt	8
4 mt	10
6 mt	15

B150EP27

- Perno per porte battenti da applicare ad estrusi Fluido+.
- Pernio para puertas batientes, por aplicar a perfiles Fluido+.
- Spindle for swing doors, to be applied to Fluido+ profiles.
- Drehpunkt für Pendeltüren für Fluido+ Profilen.
- Pivot pour portes battantes à appliquer sur profils Fluido+.

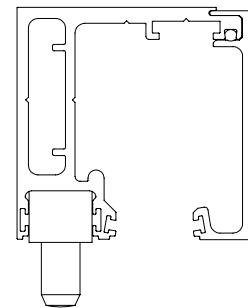
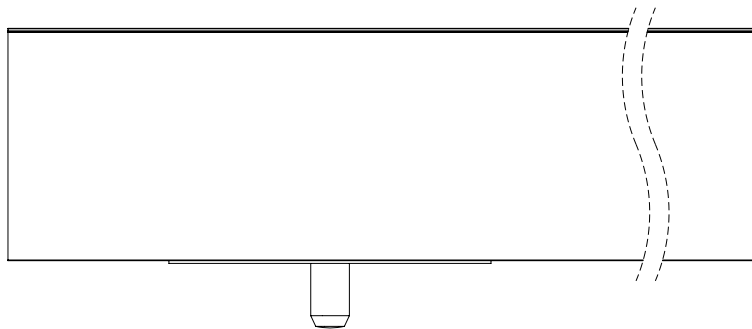
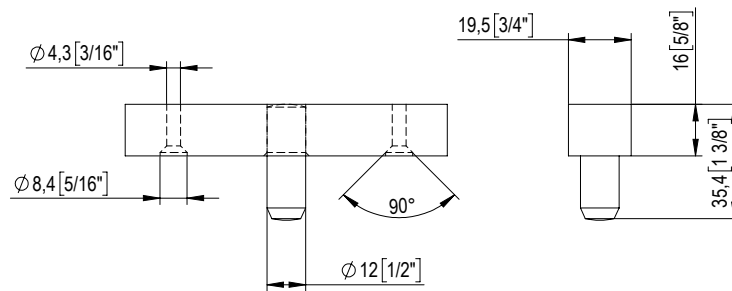
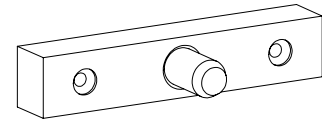
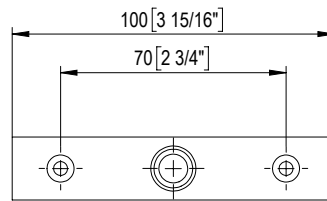

ESEMPIO APPLICAZIONE CON CERNIERA UNICA 101E10 - 100E20

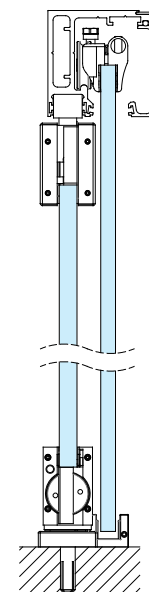
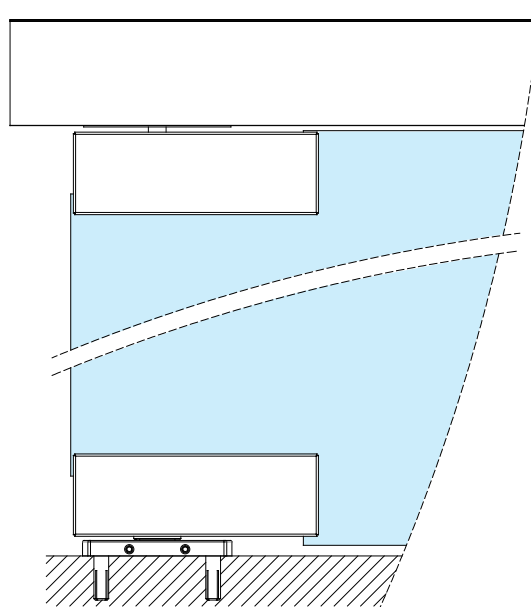
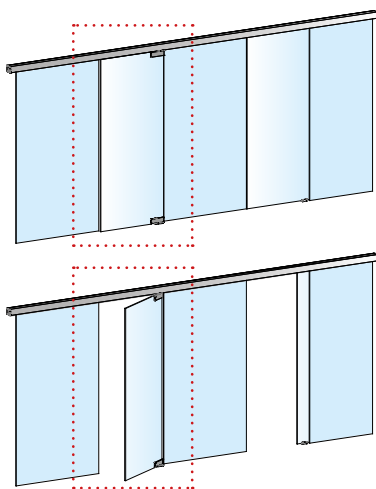

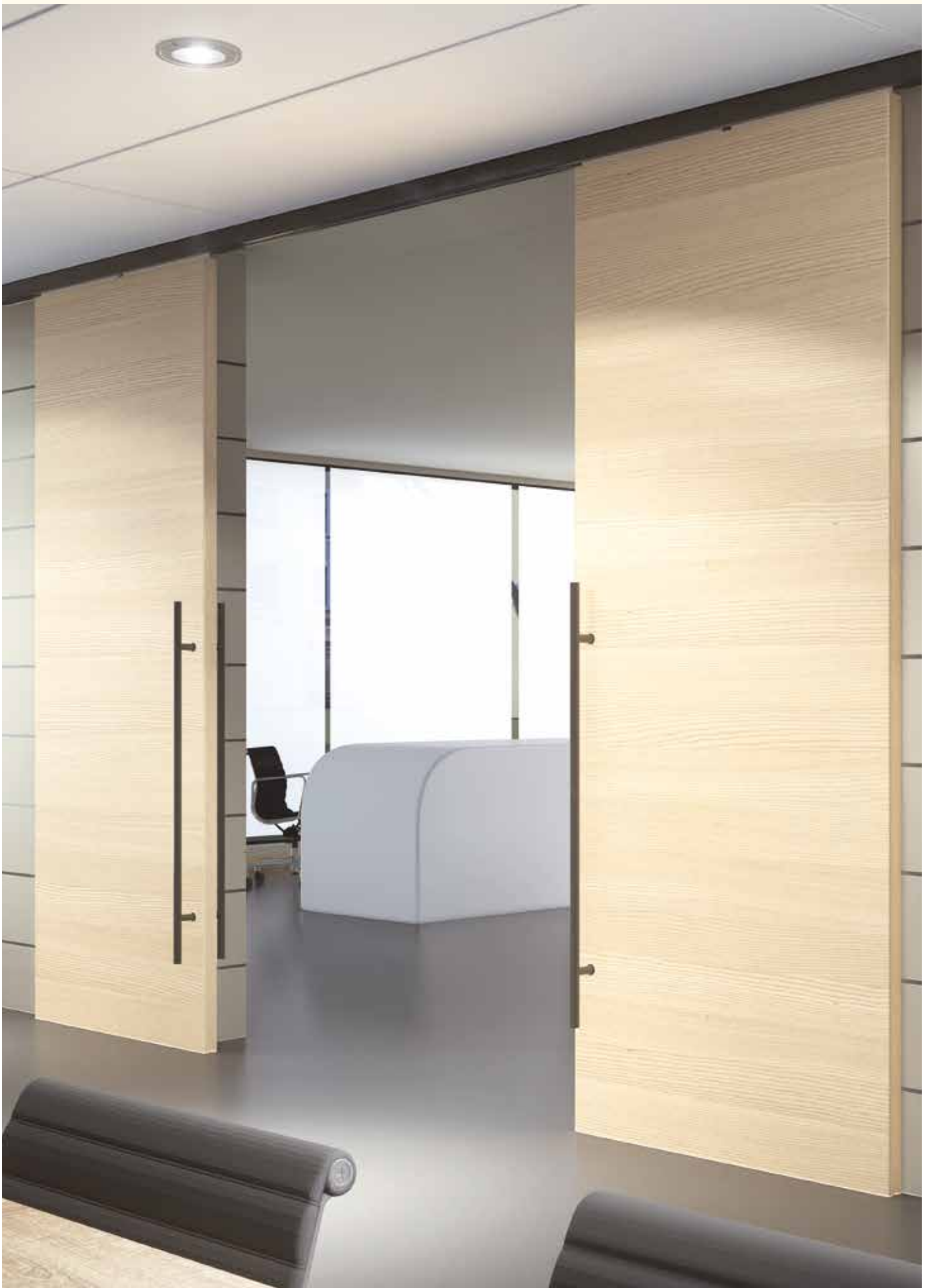

scorrevoli / sliding

system **FLO**

Alluminio / Aluminium - finiture / colors 02

Sistema scorrevole compatto di soli 50mm di altezza. Facile installazione. Munito di un innovativo sistema di ammortizzazione variabile e di regolazione di messa a bolla direttamente da terra. Design essenziale.

Sistema de deslizamiento compacto de sólo 50 mm de altura. Fácil instalación. Equipado con un innovador sistema de amortiguación de las reglas y reglamentos establecidos en marcha la burbuja de la tierra. Diseño esencial.

Compact sliding system only 50 mm high. Easy installation. Equipped with an innovative damping system which is adjustable and adjusts set-up bubble directly from the ground. Essential design.

Kompaktes Schiebetürsystem mit einer Gesamthöhe von 50 mm. Einfache Montage und Nivellierungseinstellung der Türhöhe direkt vom Boden aus. Regulierbare Fangstopper, mit denen die Öffnung und Schließung des Türflügels in Funktion des Gewichtes verlangsamt werden kann. Minimalistisches Design.

Système compact pour porte coulissante de seulement 50 mm de hauteur. Installation facile. Le produit Flo est équipé d'un système d'amortisseur réglable et d'un ajustement possible au sol grâce au niveau à bulle. Design discret et minimaliste.



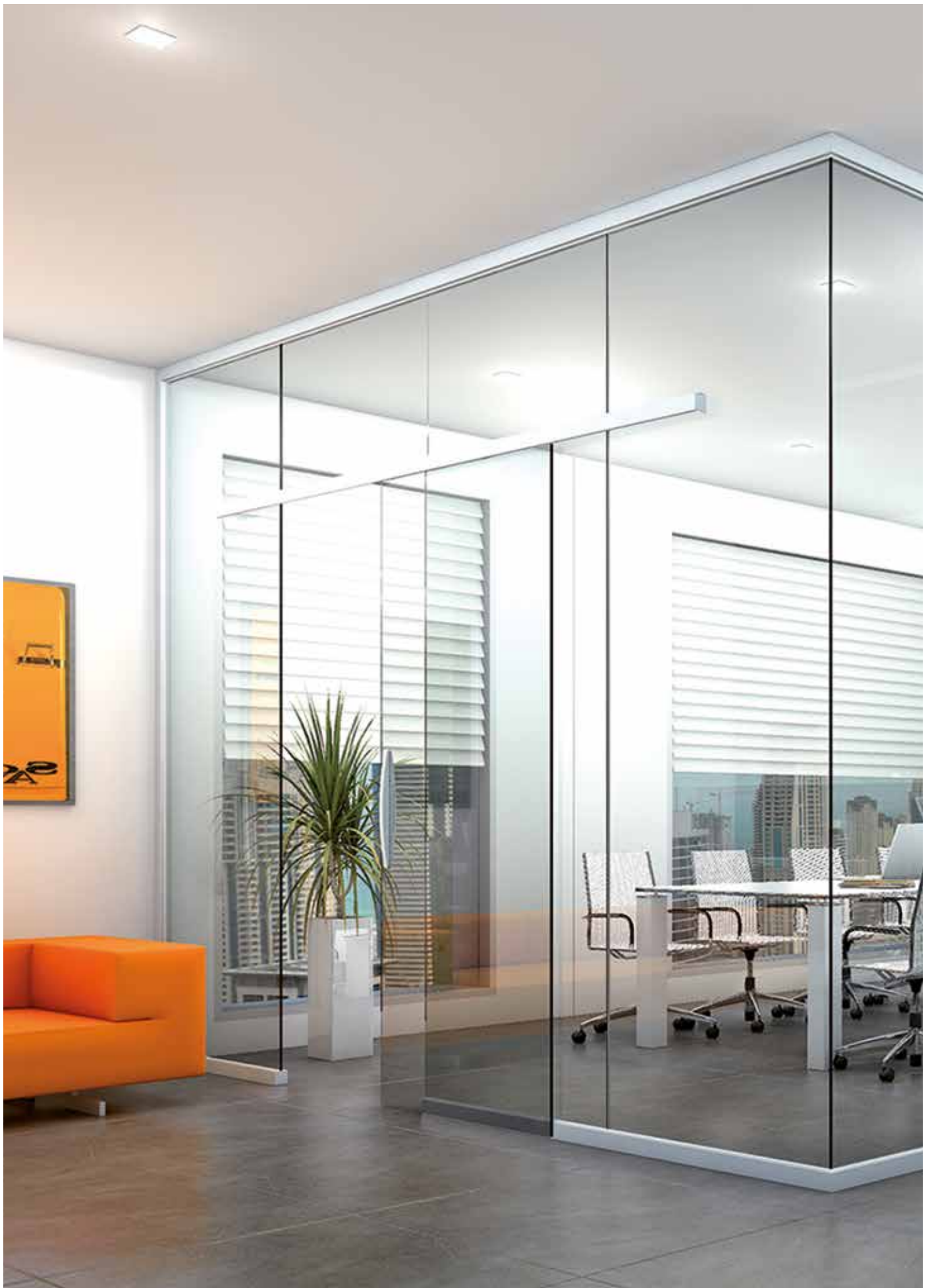

BF00

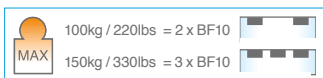

- Kit scorrevole Flo ad un'anta - fissaggio su vetro .
- kit Flo para una puerta corredera y fijación en el vidrio.
- Sliding set Flo – one glazing fixing on glass.
- Set Schiebesystem Flo mit einem Flügel – Befestigung am Glas.
- Kit coulissant "Flo" pour 1 vantail, fixation sur verre.

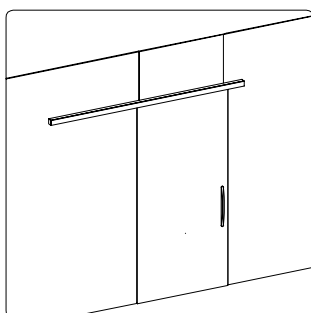

Compreso

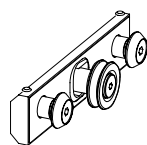

2X
BF10

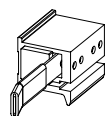

2X
BF30

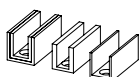

1X
BN50



2X
BF60



6X
BF70

Included

Non compreso



BF40
BF40-2 (2,5m)
BF40-5 (5m)



BF45
BF45-2 (2,5m)
BF45-5 (5m)



5BN0

Not included

BF01

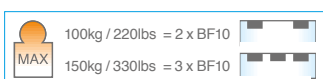

- Kit scorrevole Flo a due ante - fissaggio su vetro.
- Kit Flo para dos puertas correderas y fijación en el vidrio.
- Sliding set Flo – on two glazing fixing on glass.
- Set Schiebesystem Flo mit zwei Flügeln – Befestigung am Glas.
- Kit coulissant "Flo" pour 2 vantaux, fixation sur verre.

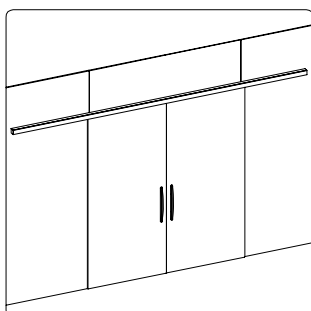

Compreso

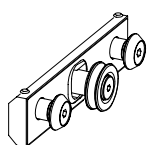

4X
BF10

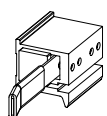

4X
BF30

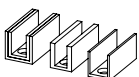

2X
BN50

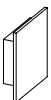

2X
BF60



9X
BF70

Included

Non compreso



BF40
BF40-2 (2,5m)
BF40-5 (5m)



BF45
BF45-2 (2,5m)
BF45-5 (5m)



5BN0

Not included

BF03

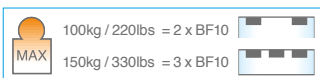
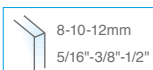

- Kit scorrevole Flo ad un anta - fissaggio a vetro con muro laterale.
- Kit para puerta corredera Flo una puerta - fijación vidrio con pared lateral.
- Sliding set Flo – one glazing fixing on glass with sideway wall.
- Set Schiebesystem FLO mit einem Flügel - Befestigung am Glas und seitliche Wand.
- Kit coulissant "Flo" pour 1 vantail, fixation sur verre, mur latéral.

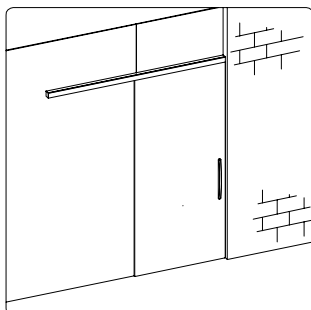

Compreso

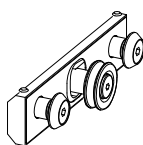

2X
BF10

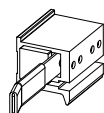

2X
BF30

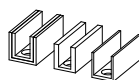

1X
BN50

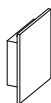

1X
BF60



5X
BF70



1X
BF90

Included

Non compreso



BF40
BF40-2 (2,5m)
BF40-5 (5m)



BF45
BF45-2 (2,5m)
BF45-5 (5m)

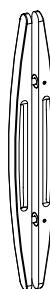

5BN0

Not included

BF05

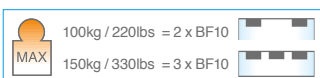
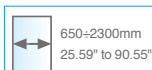
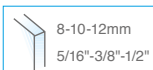

- Kit scorrevole Flo ad un anta - fissaggio su muro.
- Kit Flo para una puerta corredera y fijación en la pared.
- Sliding set Flo – one glazing fixing on wall.
- Set Schiebesystem Flo mit einem Flügel – Befestigung an der Wand.
- Kit coulissant "Flo" pour 1 vantail, fixation sur mur.

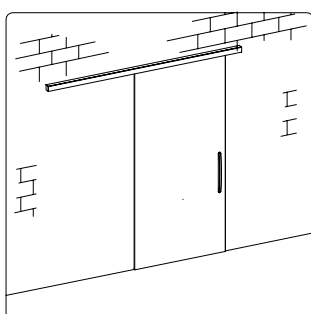

Compreso

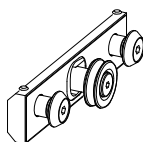

2X
BF10

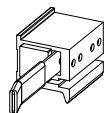

2X
BF30

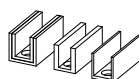

1X
BN50



2X
BF60

Included

Non compreso



BF40
BF40-2 (2,5m)
BF40-5 (5m)



BF45
BF45-2 (2,5m)
BF45-5 (5m)

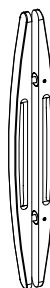

5BN0

Not included

BF06

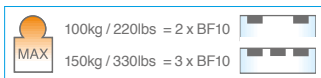
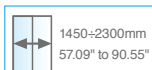
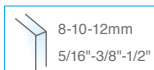

- Kit scorrevole Flo a due ante - fissaggio su muro o a soffitto.
- Kit Flo para dos puertas correderas y fijación en la pared o a techo.
- Sliding set Flo – two glazings fixing on wall or ceiling.
- Beschlagset Zweiflügelige Schiebetür Flo mit Befestigung an Wand oder Decke.
- Kit coulissant "Flo" pour 2 vantaux, fixation sur mur.

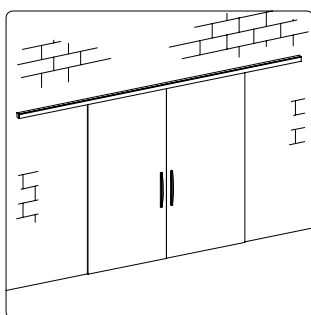

Compreso

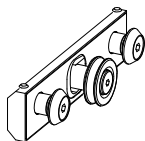

4X
BF10

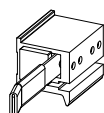

4X
BF30

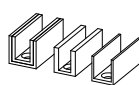

2X
BN50



2X
BF60

Included

Non compreso



BF40
BF40-2 (2,5m)
BF40-5 (5m)



BF45
BF45-2 (2,5m)
BF45-5 (5m)

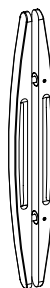

5BN0

Not included

BF07

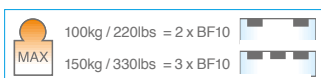
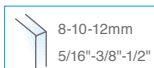

- Kit scorrevole Flo ad un anta - fissaggio a soffitto.
- Kit para puerta corredera Flo una puerta-fijación a techo.
- Sliding set Flo – one glazing fixing on ceiling.
- Set Schiebesystem Flo mit einem Flügel - Deckebefestigung.
- Kit coulissant "Flo" pour 1 vantail, fixation au plafond.

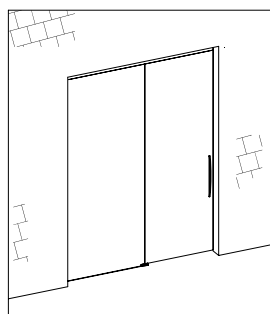

Compreso

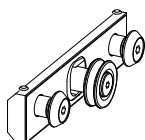

2X
BF10

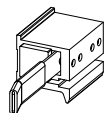

2X
BF30

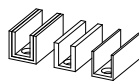

1X
BN50

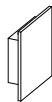

2X
BF60

Included

Non compreso

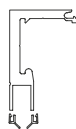

BF75
BF75-2 (2,5m)
BF75-5 (5m)
+ PCC16



BF45
BF45-2 (2,5m)
BF45-5 (5m)

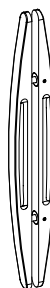

5BN0

Not included

BF08

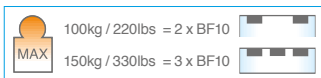
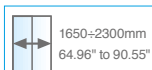
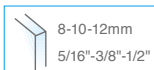

- Kit scorrevole Flo a due ante - fissaggio a soffitto.
- Kit Flo para dos puertas correderas y fijación a techo.
- Sliding set Flo – on two glazing fixing on ceiling.
- Set Schiebesystem Flo mit zwei Flügeln –Deckebefestigung.
- Kit coulissant “Flo” pour 2 vantaux - Fixation au plafond.

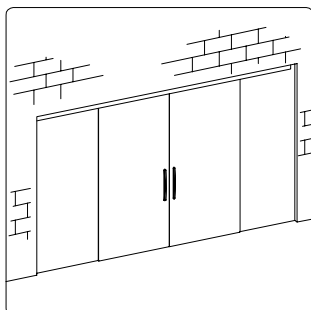

Compresso

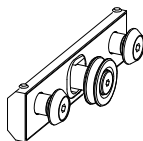

4X
BF10

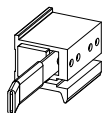

4X
BF30

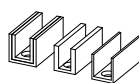

2X
BN50



2X
BF60

Included

Non compresso

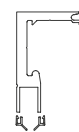

BF75
BF75-2 (2,5m)
BF75-5 (5m)
+ PCC16



BF45
BF45-2 (2,5m)
BF45-5 (5m)



5BN0

Not included

BF40

- Barra per sistema scorrevole Flo. Disponibile nelle lunghezze: 2,5m (BF40-2) e 5m (BF40-5).
- Barra para puerta corredera Flo. Disponible en 2.5 metros (BF40-2) y 5 metros (BF40-5).
- Bar for sliding system Flo – Available in following lengths : 2,5 mt (BF40-2) and 5 mt (BF40-5)
- Stange für Schiebesystem Flo. In den Längen: 2,5m (BF40-2) und 5m (BF40-5) verfügbar.
- Barre pour système coulissant Flo. Disponible en longueur : 2.5m (BF40-2) et 5m (BF40-5).

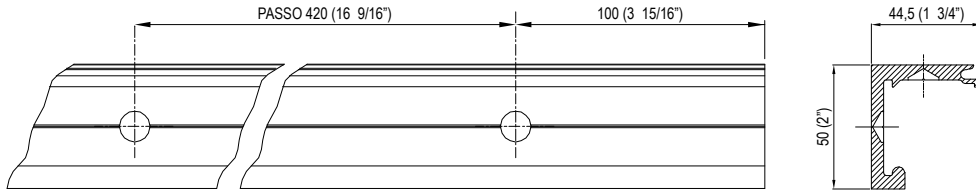

LE BARRE VENGONO FORNITE CON PREFORATURE CIECHE A PASSO 400 PER IL FISSAGGIO A MURO (PARETE O SOFFITTO) - LA BARRA VIENE MANUFACTURADA CON AGUJEROS CIEGOS DE PASO 400 PARA LA FIJACIÓN (PARED O TECHO) - THE BARS ARE SUPPLIED WITH BLIND DRILLING BY SPACING 400 FOR FIXING WALL (WALL OR CEILING) - DIE STANGEN SIND MIT SACKLÖCHER MIT ABSTAND 400 FÜR DIE WANDFIXIERUNG (WAND ODER DECKE) GELIEFERT - LES BARRES SONT PRÉ-PERCÉES AVEC DES ENTRAXES DE 400MM POUR LA FIXATION AU MUR (OU PLAFOND)

FISSAGGIO BINARIO BF40 - ESQUEMA DE FIJACIÓN DE LA BARRA BF40 BF40 BAR FIXING DIAGRAM STANGENBEFESTIGUNGSSCHEMA BF40 - FIXATION DE LA BARRE BF40

PER PORTA FINO A 60 KG
PARA PUERA HASTA 60 KG
FOR DOORS UP TO 60 KG
FÜR TÜREN BIS ZU 60 KG
POUR PORTES JUSQU'À 60 KG

PER PORTA DA 61 A 100 KG
PARA PUERA DE 61 A 100 KG
FOR DOORS FROM 61 TO 100 KG
FÜR TÜREN ZWISCHEN 61 KG UND 100 KG
POUR PORTE DE 61 A 100 KG

Nota: I dati sotto descritti sono indicativi. Il numero di fori barra da utilizzare per il fissaggio sono a discrezione dell'installatore e dipendono dalle condizioni del muro e dei tasselli ad espansione utilizzati, e dalle dimensioni della porta.

Nota: Los datos descritos a continuación son indicativos. El número de agujeros de la barra a utilizar para la fijación es una decisión discrecional del instalador que depende del estado de la pared y de los tacos de expansión utilizados y de las dimensiones de la puerta.

N.B. The data below are merely indicative. The number of holes required to secure the bar are up to the fitter and depend on the conditions of the wall and wall plugs used and the door dimensions.

Hinweis: Die unten gemachten Angaben sind richtungswisend. Die Anzahl der für die Befestigung anzuwendenden Stangenlöcher liegt im Ermessen des Installateurs und hängt vom Zustand der Wand, der verwendeten Spreizdübel und der Türegöße ab.

NB : les informations ci-après sont indicatives. Le nombre de trous requis pour sécuriser la barre dépend de l'installateur et du type de support et des dimensions de la porte.

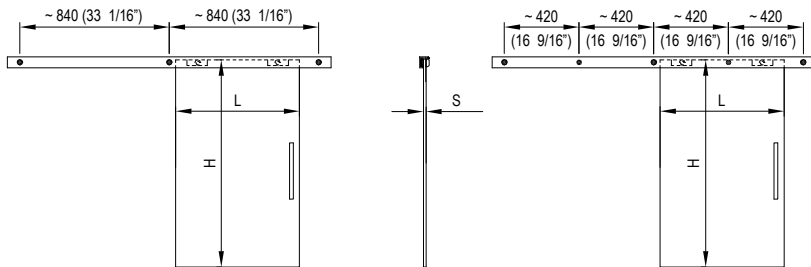

DETTAGLIO FORATURA PER FISSAGGIO A MURO

DETALLE AGUJERO PARA FIJACIÓN A PARED - DETAILS DRILLING FOR WALL FIXING
DETAIL DES BOHRENS FÜR DIE WANDFIXIERUNG - DETAILS DES PERCAGES POUR FIXATION AU MUR

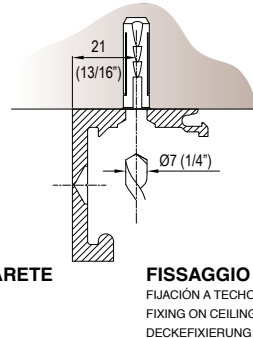
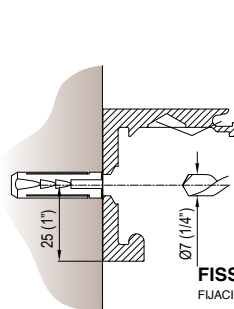
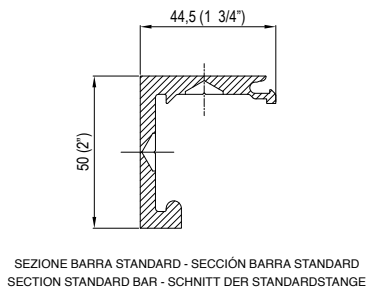

DETTAGLIO FORATURA FISSAGGIO A VETRO

DETALLE AGUJERO PARA FIJACIÓN A VIDRIO - DETAILS DRILLING FOR GLASS FIXING
DETAIL DES BOHRENS FÜR DIE GLASFIXIERUNG - PLAN DE PERCAGE POUR FIXATION SUR VERRE

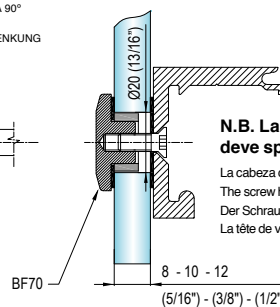
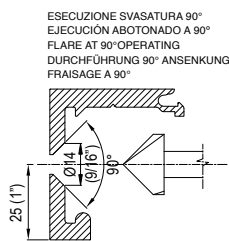
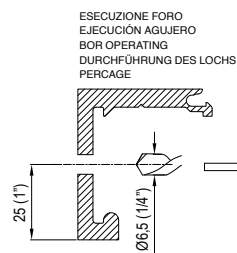
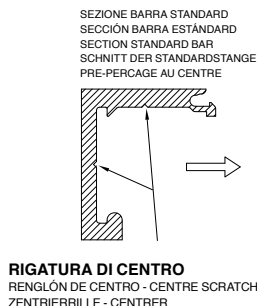

BF00

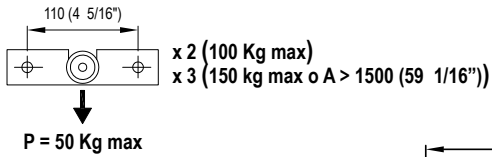
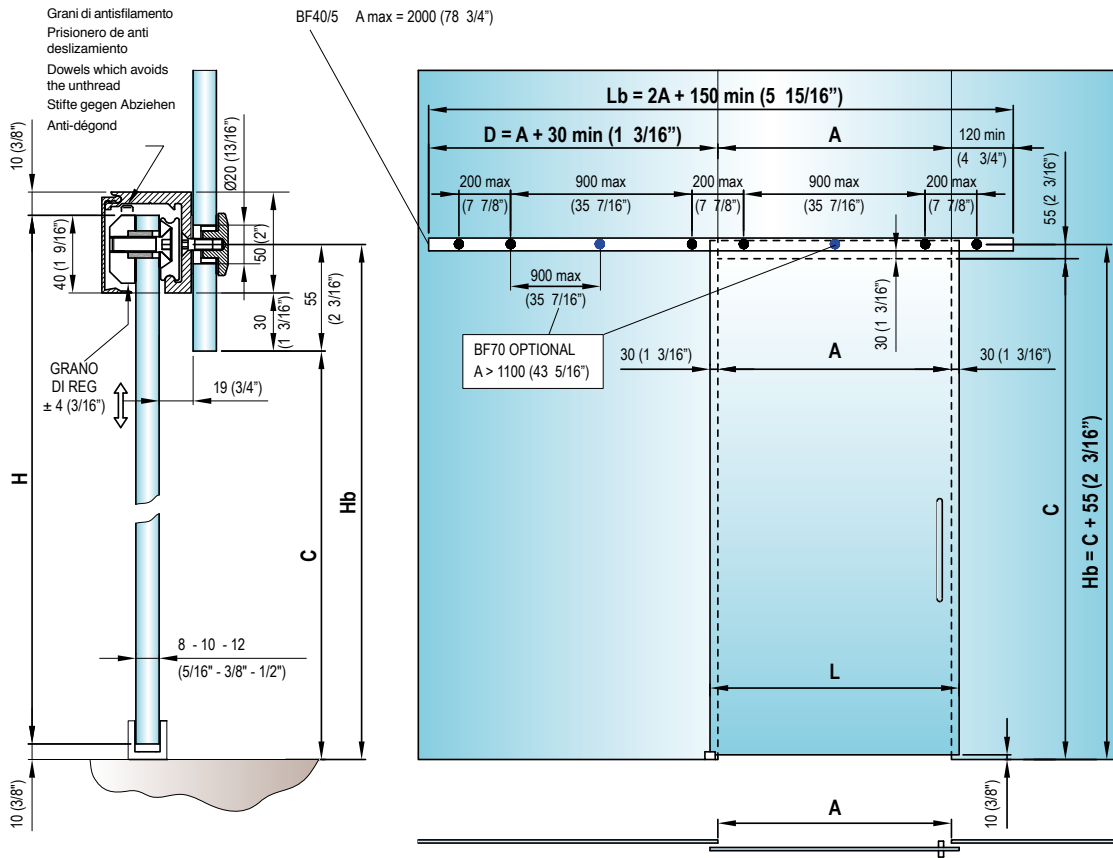

Applicazioni fuori standard su richiesta
Not standard application upon request

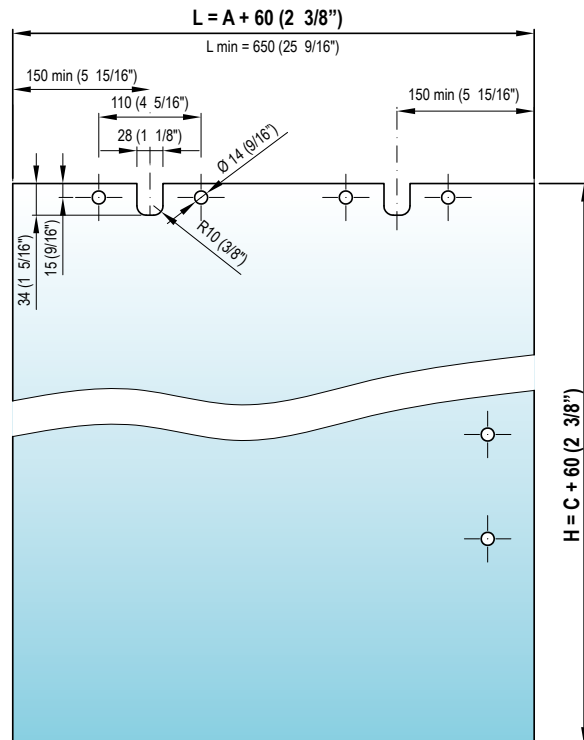

BF01

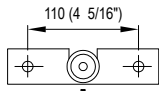
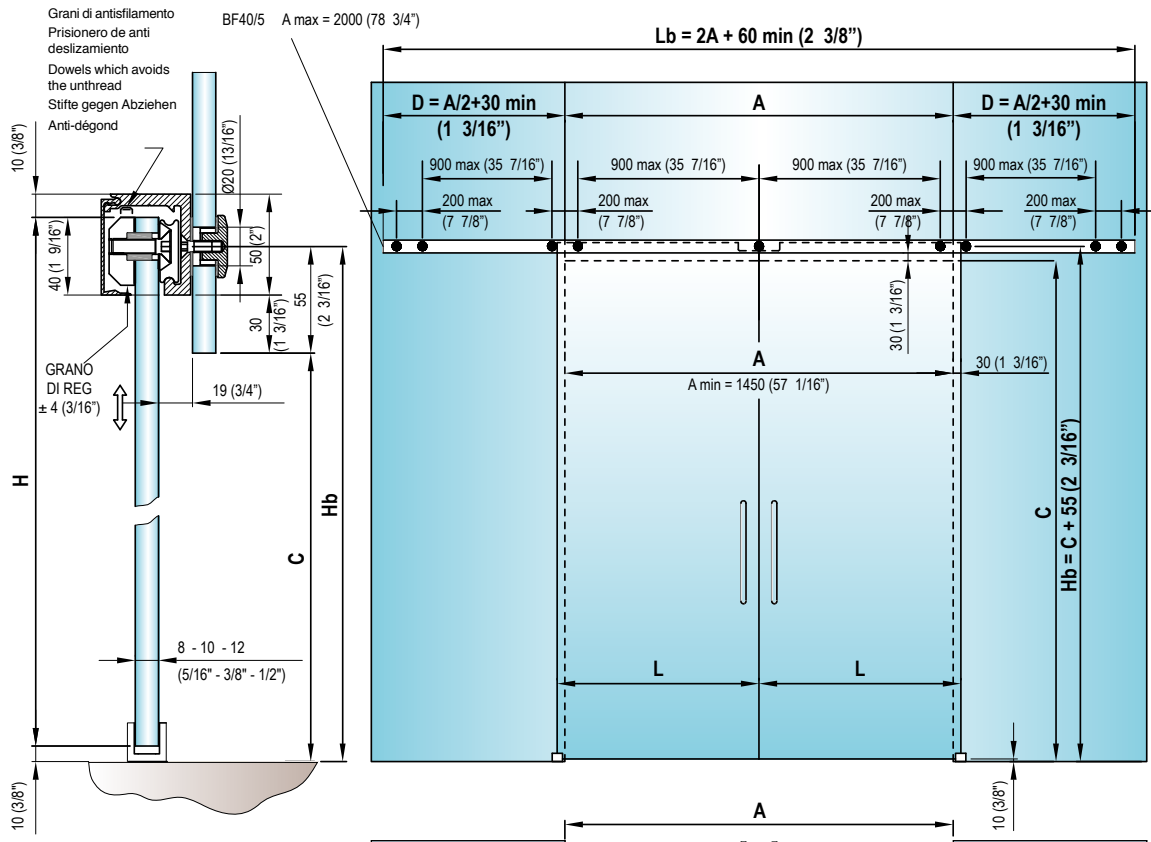

x 2 (100 Kg max)
Applicazioni P > 100 kg e A > 2000 su richiesta
Application P > 100 kg or A > (78 3/4") upon request

P = 50 Kg max

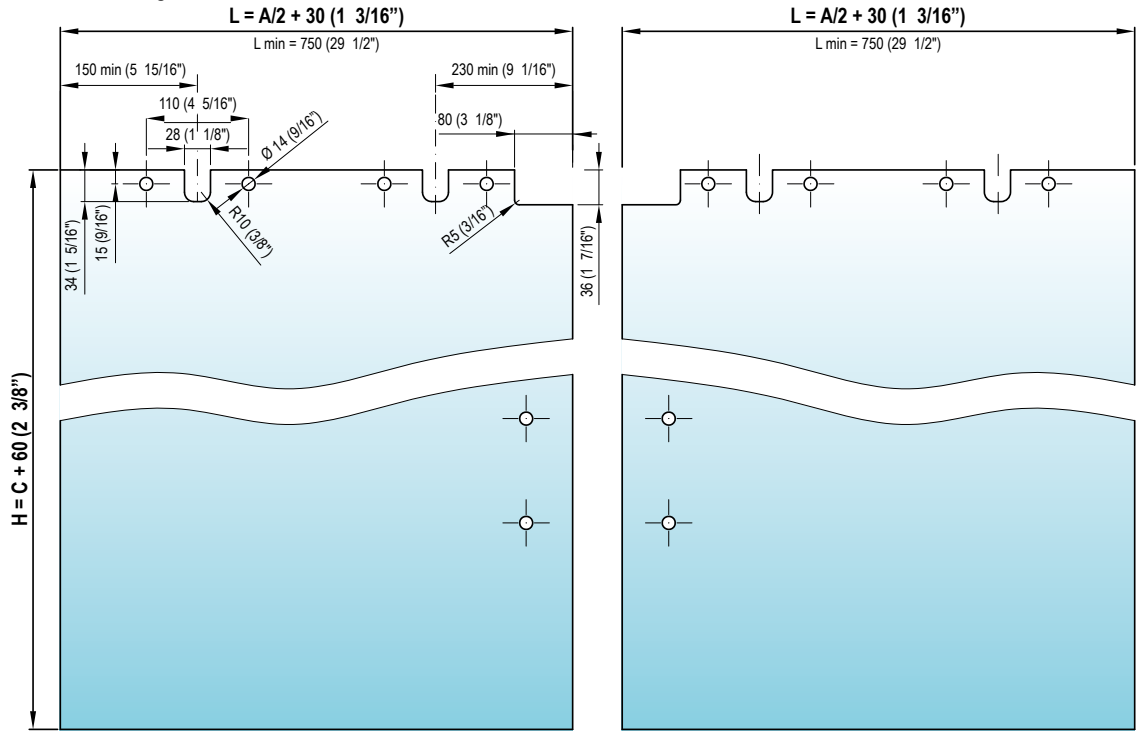

BF03

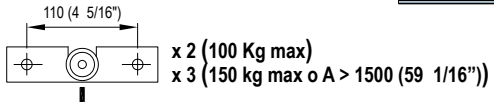
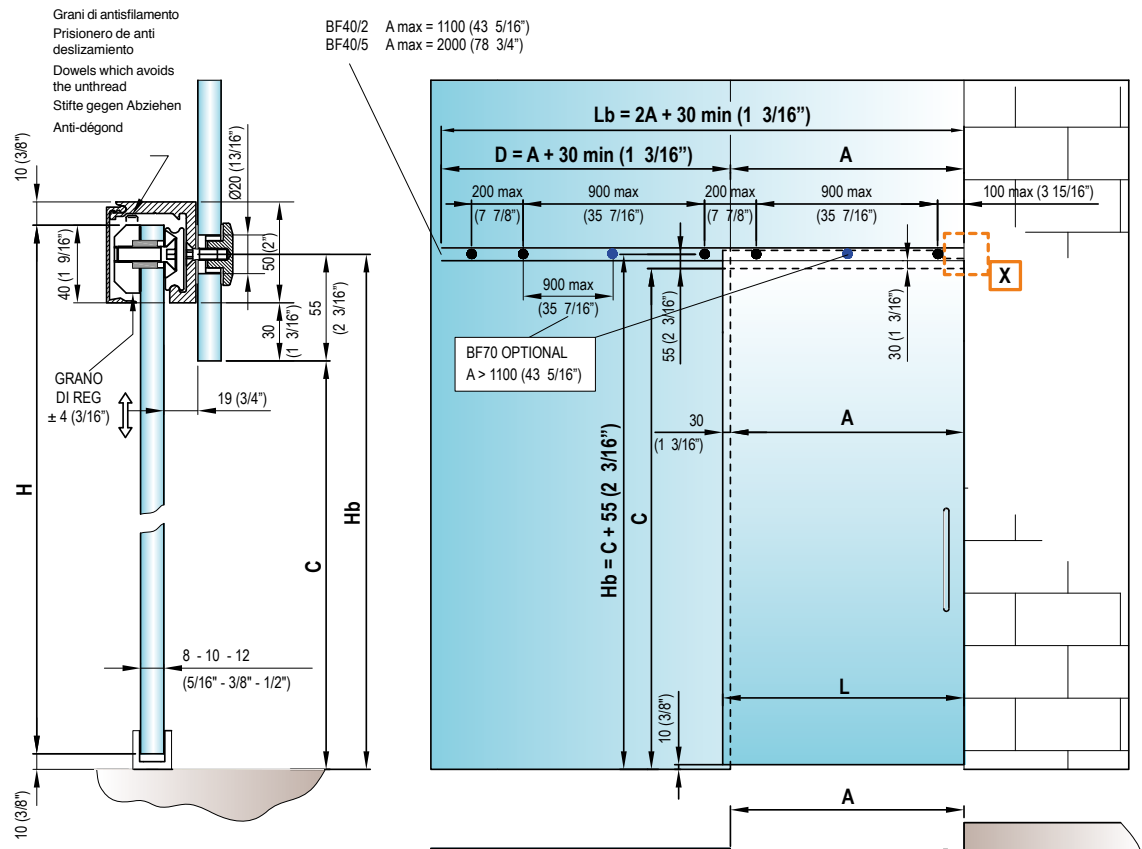

P = 50 Kg max

Applicazioni fuori standard su richiesta
Not standard application upon request

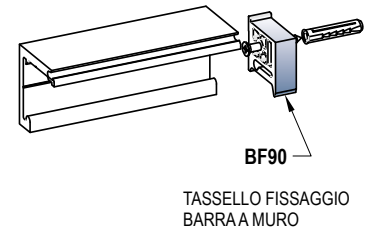
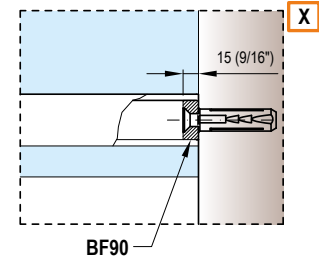
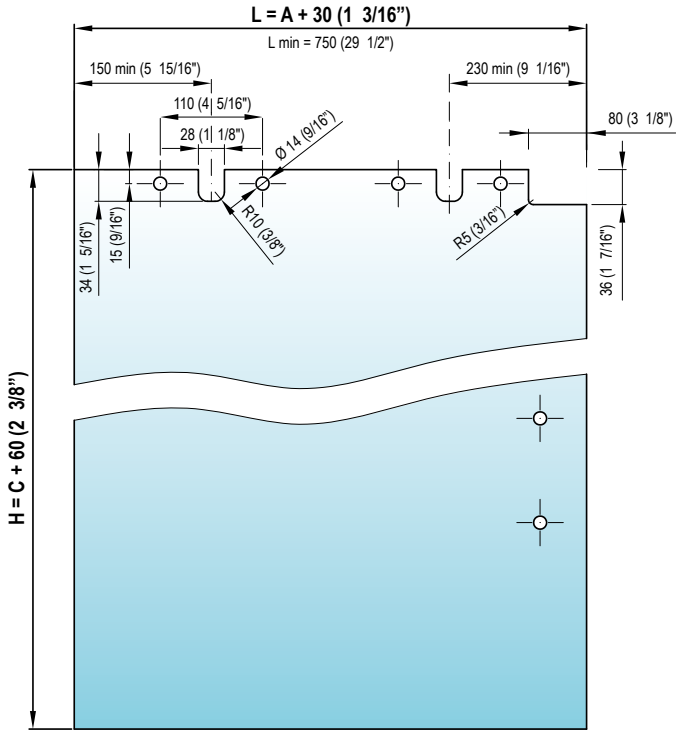

BF05

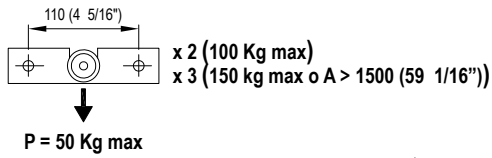
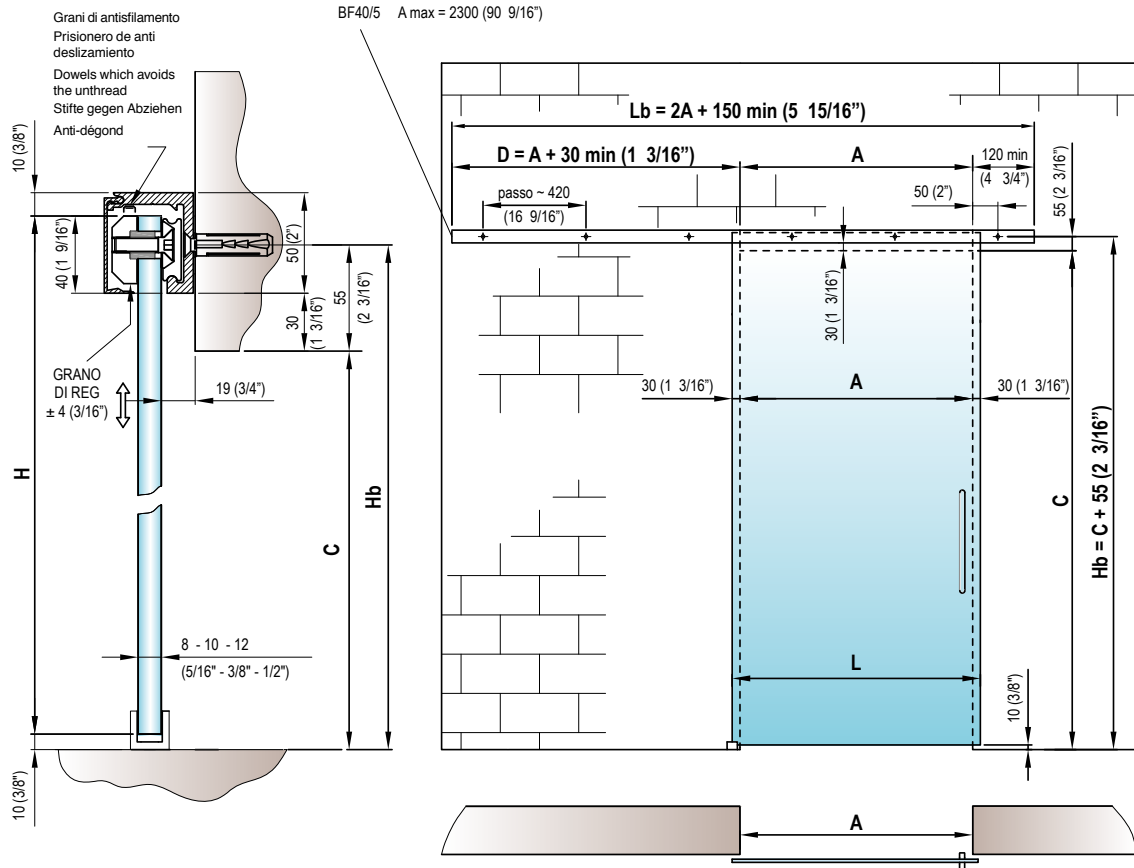

Applicazioni fuori standard su richiesta
Not standard application upon request

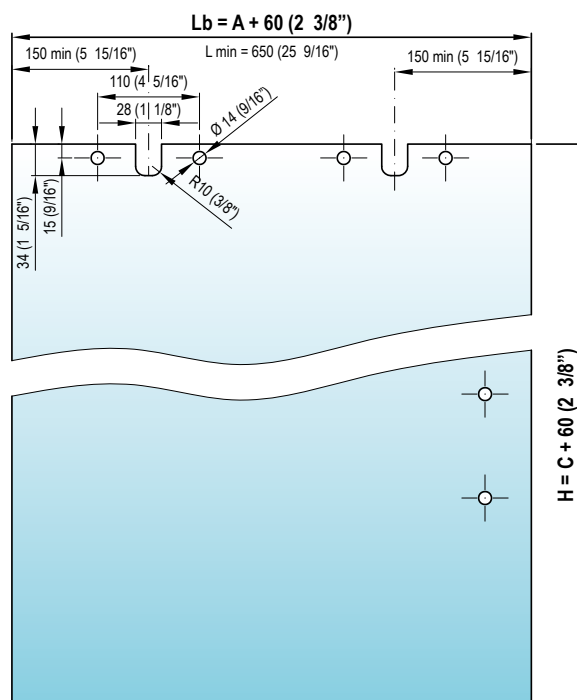

BF06

Fissaggio a soffitto.
 Fijación a techo.
 Fixing on ceiling.
 Deckebefestigung.
 Fixation au plafond.

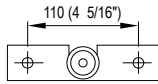
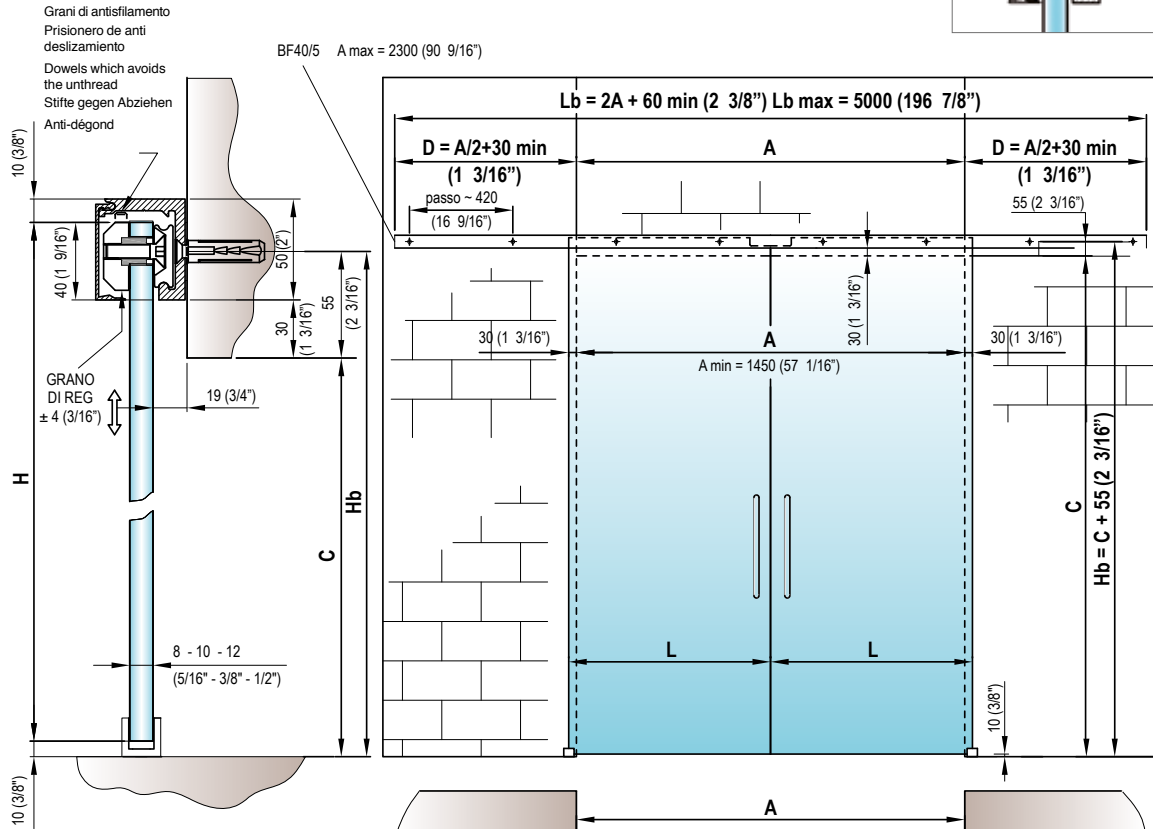
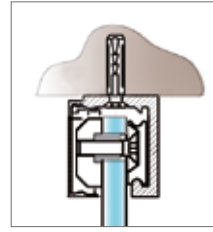

x 2 (100 Kg max)

Applicazioni P > 100 kg e A > 2000 su richiesta
 Application P > 100 kg or A > (78 3/4") upon request

P = 50 Kg max

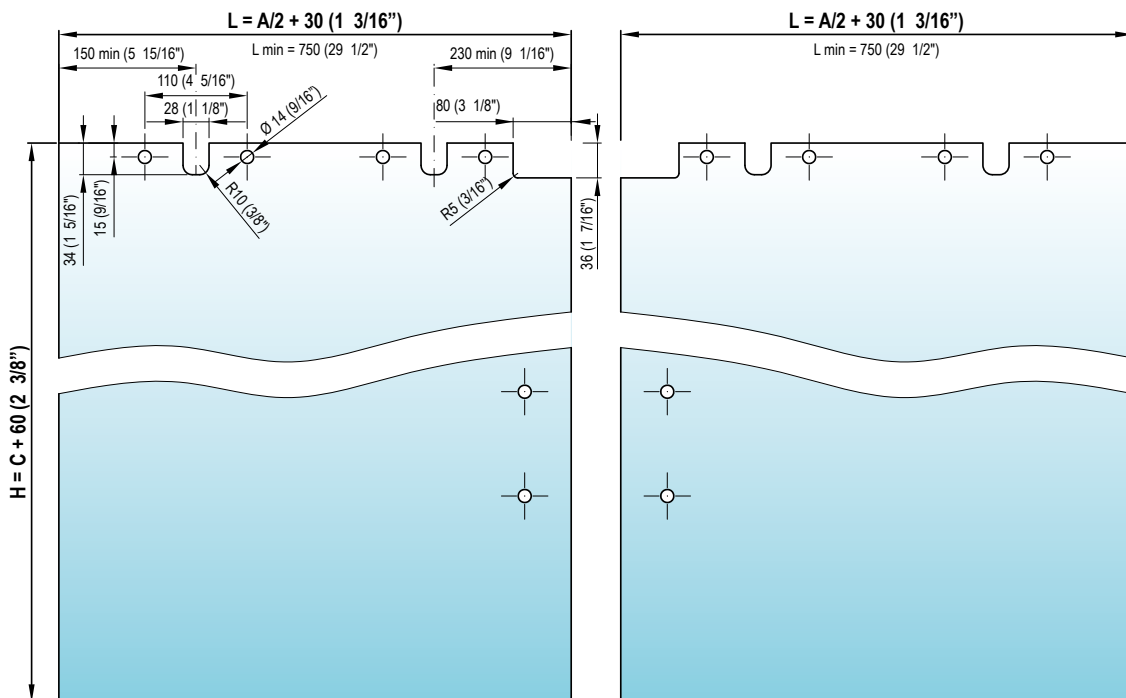

BF07

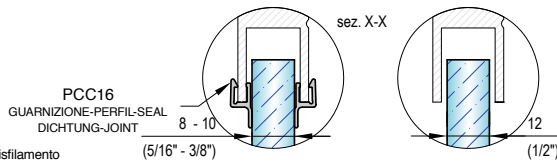

BF75/2	2500 (98 7/16")	BF40/5	A max = 1100 (43 5/16")
BF75/5	5000 (196 7/8")		A max = 2300 (90 9/16")

Grani di antisfilamento
 Prisonero de anti desluzamiento
 Dowels which avoids the unthread
 Stifte gegen Abziehen
 Anti-dégond

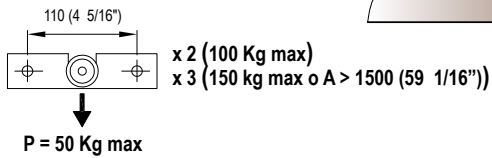
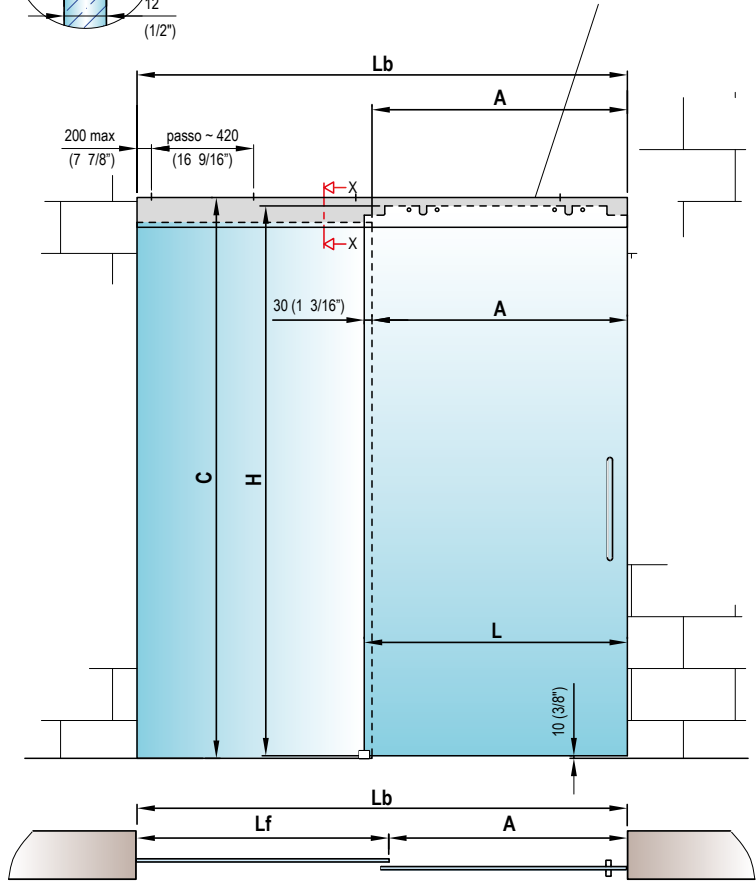
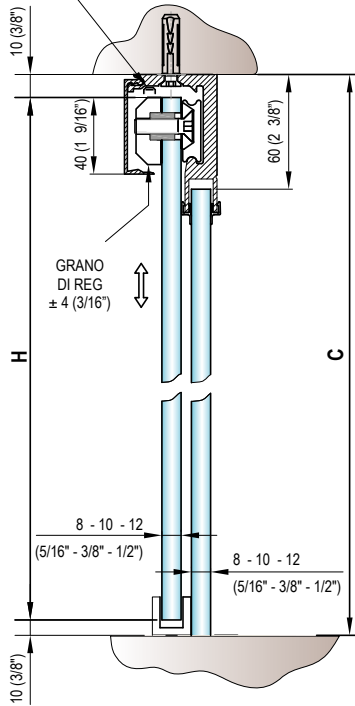

Applicazioni fuori standard su richiesta
 Not standard application upon request

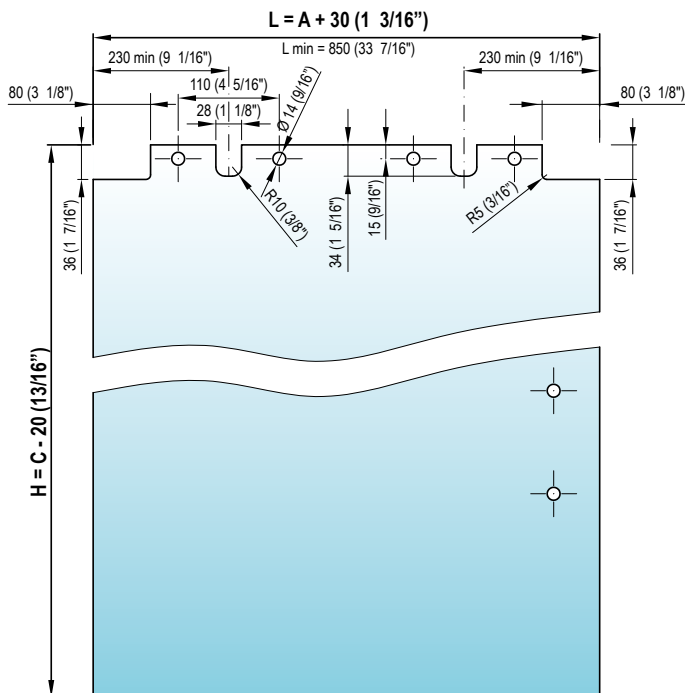

BF08

PCC16
GUARNIZIONE-PERFIL-SEAL
DICHTUNG-JOINT

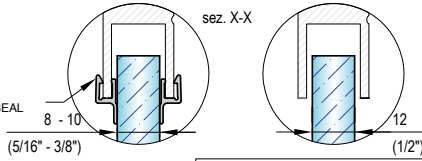

BF75/5 5000 (196 7/8")

BF40/5 A max = 2300 (90 9/16")

Grani di antifilamento
Prisionero de anti deslizamiento
Dowels which avoids the unthread
Stifte gegen Abziehen
Anti-dégond

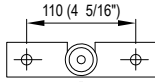
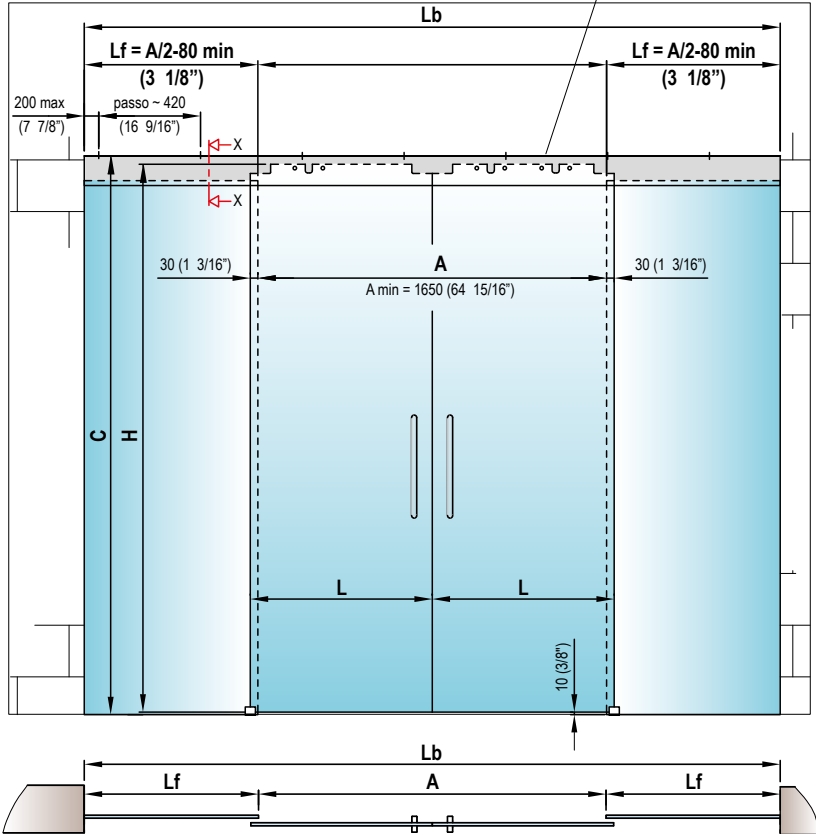
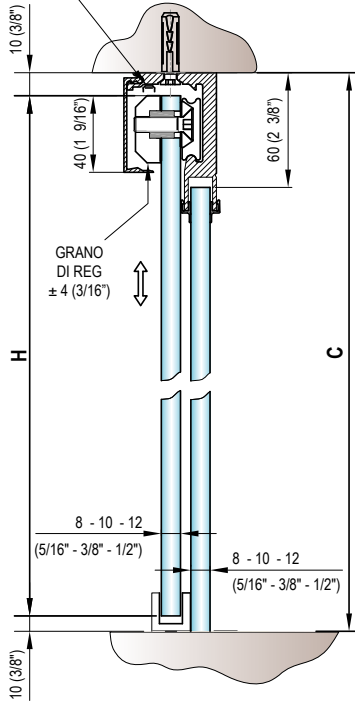

x 2 (100 Kg max)

Applicazioni P > 100 kg e A > 2000 su richiesta
Application P > 100 kg or A > (78 3/4") upon request

P = 50 Kg max

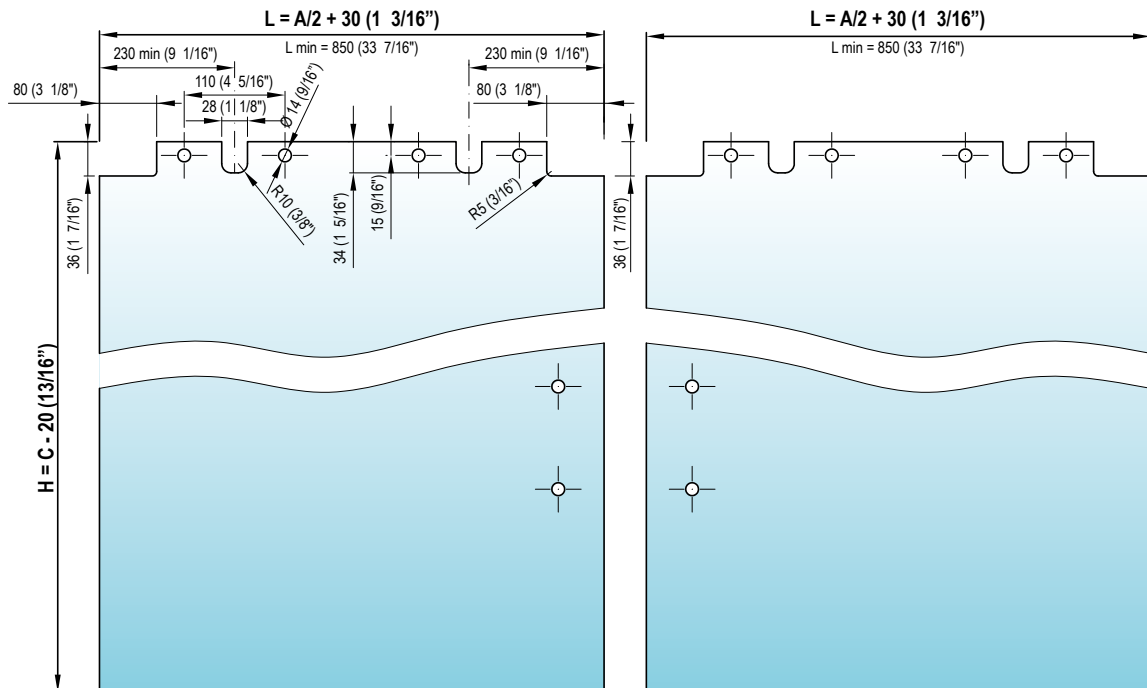

scorrevoli / sliding

system **SLAK & SLAK 2**

Alluminio / Aluminium - finiture / colors 02

SLAK

Sistema scorrevole con veletta dalle dimensioni ridotte. Sobrio ed elegante in 103mm di altezza. Il meccanismo interno è particolarmente robusto e affidabile e supporta fissaggi a parete o a soffitto nelle varianti con anta singola o doppia.

Sistema de deslizamiento con velo de espacio minor. Sobrio y elegante en 103 mm de altura. El mecanismo interno es extremadamente robusto y fiable, y apoya a la pared o el techo en las variantes con puerta simple o doble.

Sliding system with small cover panel. Simple and elegant in 103 mm high. The internal mechanism is extremely robust and reliable and supports wall or ceiling, from single to double door.

Stabiles Schiebetürsystem mit einer Gesamthöhe von 103 mm. Besonders robuster und zuverlässiger interner Mechanismus. Möglichkeit der Befestigung an Wand oder an Decke als einflügelige oder zweiflügelige Variante.

Système coulissant pincé largeur du capot d'habillage de seulement 103 mm. Mécanisme interne extrêmement robuste et fiable. Installation sur mur, plafond, un vantail ou deux vantaux. Technologie éprouvée de frottements réduits, qui assure un mouvement doux et précis.

SLAK 2

Evoluzione del sistema Slak di cui mantiene le stesse caratteristiche tecniche ed applicative, design molto differente grazie ai 50 mm di altezza con pinze fermavetro a vista.

Evolución del sistema SLAK que mantiene las mismas características técnicas y prácticas, diseño muy diferente gracias a sus 50 mm de altura con pinzas de cordón a vista.

Evolution of the Slak system which has the same technical and practical characteristics, but with a different design and 50 mm in height with glass-blocking clamps.

Weiterentwicklung des Slaksystems mit den gleichen technischen Merkmalen. Das Abdeckblech ist bewusst mit einer Gesamthöhe von 50 mm minimal gehalten. Optisch angegliche sichtbare Bänder übernehmen die stabile Tragfunktion des Türflügels.

Evolution du système Slak comportant les mêmes caractéristiques techniques avec un design très différent grâce à sa hauteur de 50 mm et ses pinces bloquant le verre.





Slak SYSTEM

- Kit scorrevole "Slak" a due ante - fissaggio su muro.
- Kit "Slak" para dos puertas - fijación en la pared.
- Two-leaves "Slak" sliding doors kit - wall mount.
- Set Schiebetüren "Slak" mit zwei Flügeln - Befestigung an der Wand.
- Kit coulissant "Slak" pour 2 vantaux - fixation sur mur + fixé dans le verre.

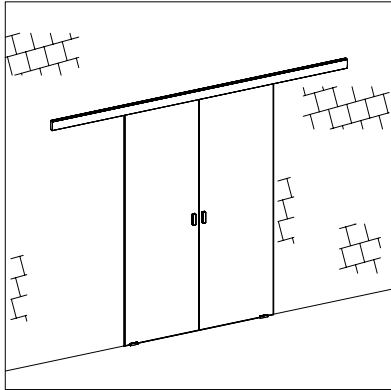

OPTIONAL

- Foro vetro Ø 10
- Hoje en el vidrio Ø 10
- Glass hole Ø 10
- Glasbohrung Ø 10
- Perçage Ø 10

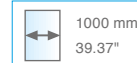
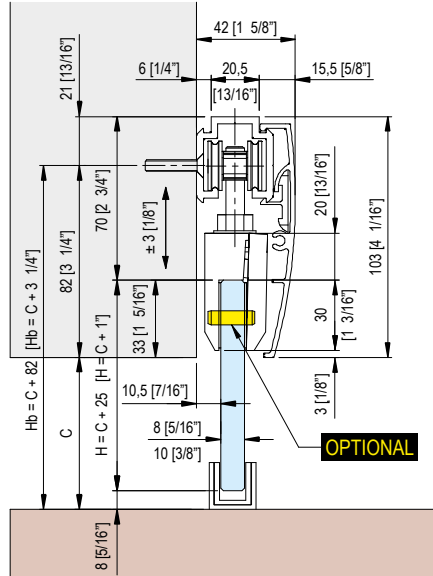

B905 + BS10 STANDARD

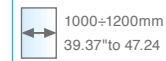
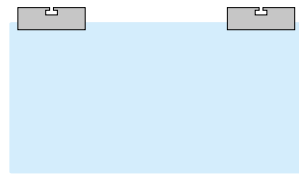
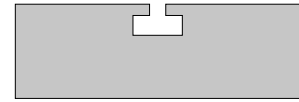

B905 + BS10 + OPTIONAL

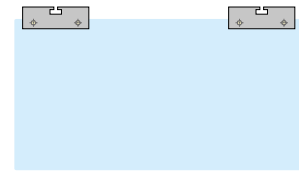
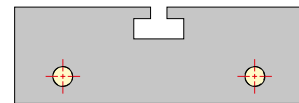

+N B905 + BS10 + OPTIONAL

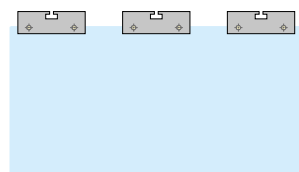
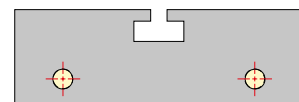

2 x BS00

B905

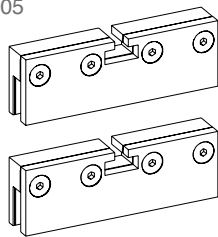

BS10

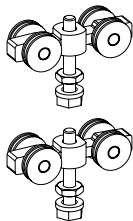

BS30

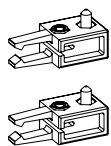

BN50

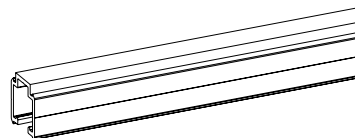
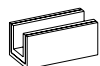

1 x BS40

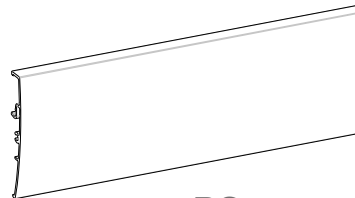

1 x BS45

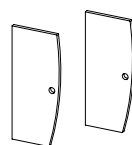

1 x BS60

Slak SYSTEM

- Kit scorrevole "Slak" ad un anta -fissaggio su muro + fisso in vetro.
- Kit "Slak" para una puerta - fijación en la pared y vidrio fijo.
- One-leaf "Slak" sliding door kit – wall mount + one fixed glass.
- Set Schiebetüren "Slak" mit einem Flügel - Befestigung an der Wand + einen Sitenteil.
- Kit coulissant "Slak" pour 1 vantail - fixation sur mur + fixation dans le verre.

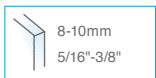
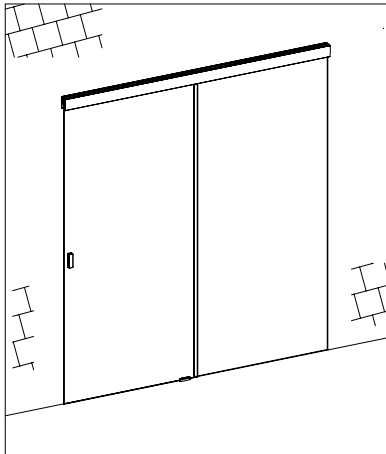

OPTIONAL
 Foro vetro Ø 10
 Hoje en el vidrio Ø 10
 Glass hole Ø 10
 Glasbohrung Ø 10
 Percage Ø 10

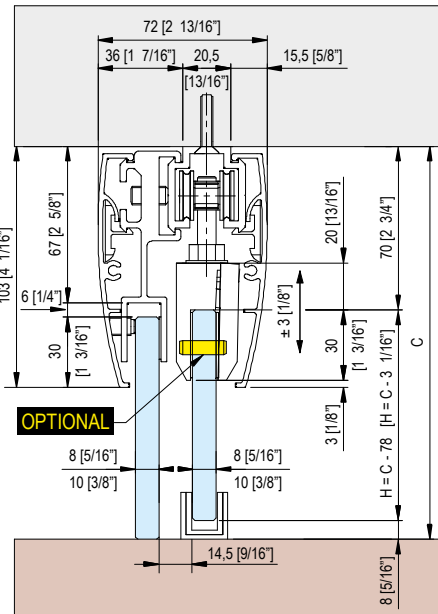

B905 + BS10 STANDARD

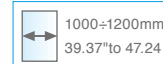
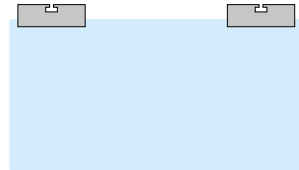
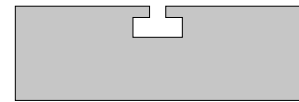

B905 + BS10 + OPTIONAL

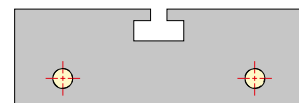

+N B905 + BS10 + OPTIONAL

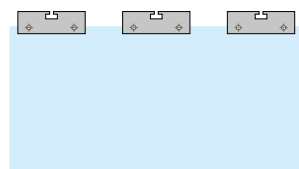
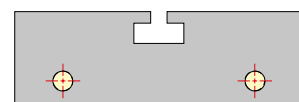

1 x BS00

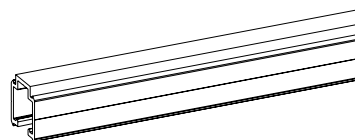
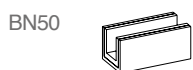
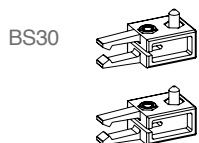
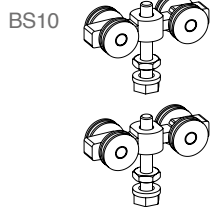
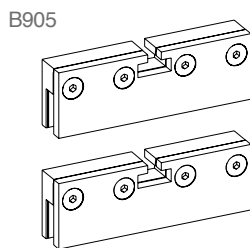

1 x BS40

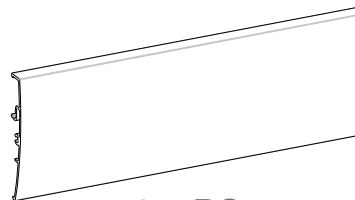

2 x BS45

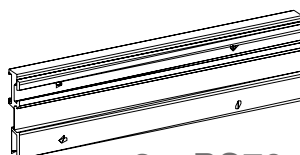

3 x BS70

Slak SYSTEM

- Kit scorrevole "Slak" a due ante - fissaggio su muro + 2 fissi in vetro.
- Kit "Slak" para una puerta - fijación en la pared y dos fijos en vidrio.
- Two-leaves "Slak" sliding door kit – wall mount + 2 fixed glasses.
- Set Schiebetüren "Slak" mit zwei Flügeln - Befestigung an der Wand + 2 Seitenteile.
- Kit coulissant "Slak" pour 2 vantaux - fixation sur mur + fixation dans le verre.

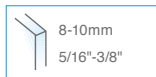
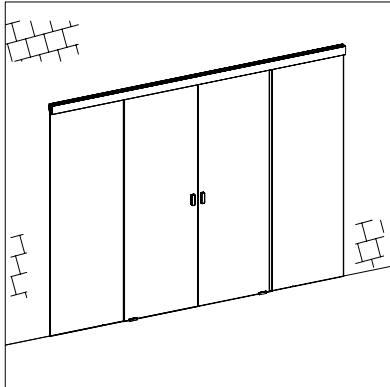

OPTIONAL
 Foro vetro Ø 10
 Hoje en el vidrio Ø 10
 Glass hole Ø 10
 Glasbohrung Ø 10
 Perçage Ø 10

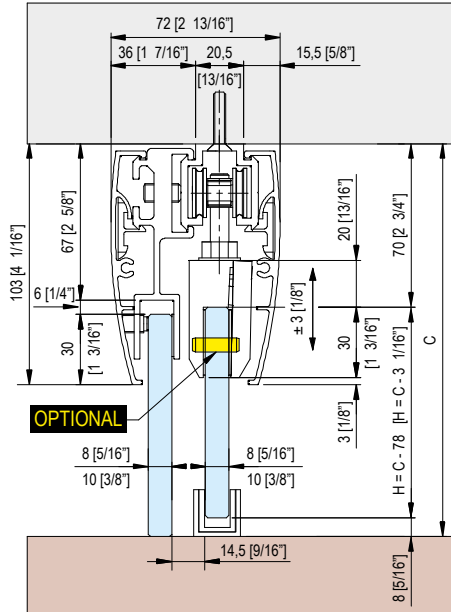

B905 + BS10 STANDARD

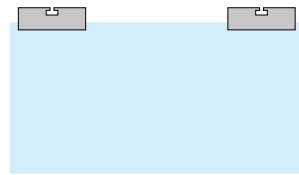
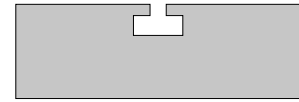

B905 + BS10 + OPTIONAL

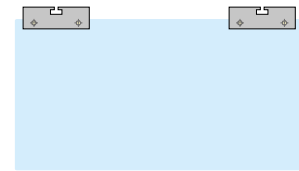
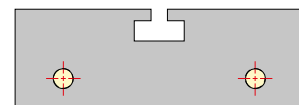

+N B905 + BS10 + OPTIONAL

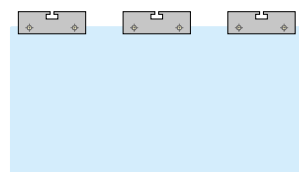
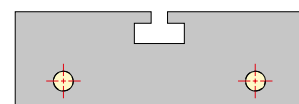

2 x BS00

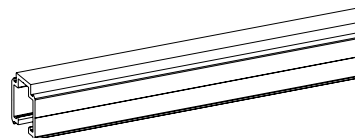
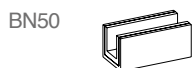
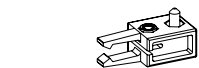
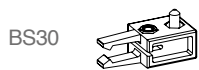
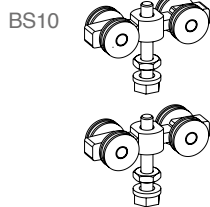
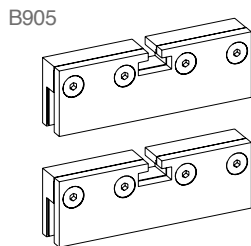

1 x BS40

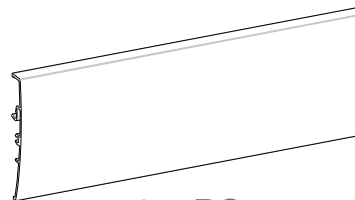

2 x BS45

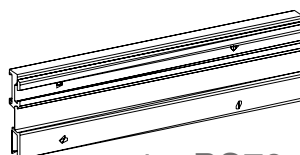

4 x BS70

BS40

- Binario Slak L = 2/3/5 mt.
- Via "Slak" L = 2/3/5 mt.
- Slak rail L = 2/3/5 mt.
- Schiene Slak L = 2/3/5 mt.
- Rail Slak L = 2/3/5 m.

Il binario ha una foratura con passo standard. In caso di taglio potrebbe essere necessario eseguire una foratura ad hoc.

La vía tiene un agujeros de "paso" estándar. Cuando corte, deba ejecutar una perforación especial.

The rail has holes with standard spacing. In case of cut, it could be necessary to realize holes ad hoc.

Die Schiene hat Bohrung mit Standardstand. Im Fall von Schnitt könnte es notwendig sein, eine Bohrung ad hoc zu realisieren.

Le rail Slak dispose de trous dont les espaces sont standards. En cas de coupe, il sera peut être nécessaire d'effectuer de nouveaux trous.

Rigatura di posizione fori
Línea de perforación
Line for holes position
Linie für Bohrungenposition
Pré-perçage

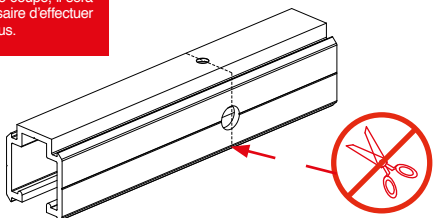
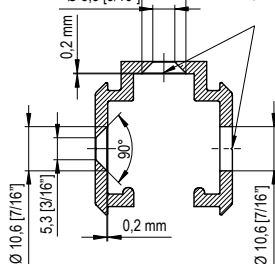

Evitare di accorciare la barra in prossimità dei fori - No acorte la barra cerca de los agujeros. - Avoid to make the bar shorter near the holes - Die Schiene in der Nähe der Bohrungen nicht abkürzen - Éviter de raccourcir la barre à proximité des trous

BS45

- Veletta Slak L = 2/3/5 mt.
- Charter "Slak" L = 2/3/5 mt.
- Slak spandrel panel L = 2/3/5 mt.
- Anlauf Slak L = 2/3/5 mt.
- Capot d'habillage Slak L = 2/3/5 m.

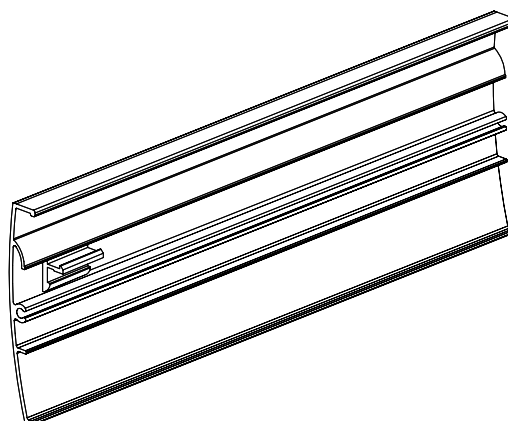
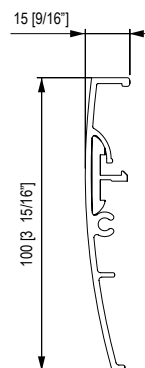

BS60

- Coppia tappi laterali Slak.
- Pareja de tapas laterales Slak.
- Slak double covers.
- Paar Deckel Slak.
- Double cache de finition Slak.

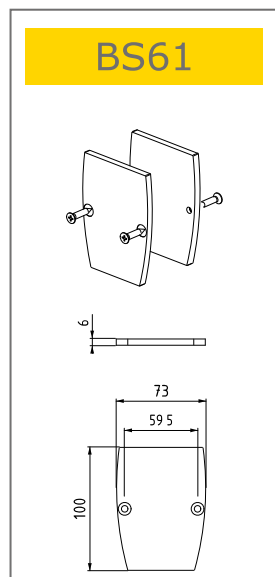
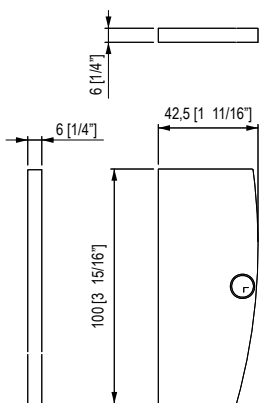

BS70

- Supporto fisso Slak L = 300 mm.
- Soporte Slak de fijo de L = 300 mm.
- Slak fixed support L = 300 mm.
- Schiene für feste Gehäuse L = 300 mm.
- Support fixe Slak L = 300 mm.

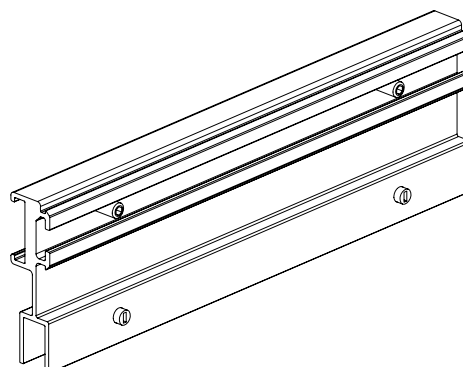
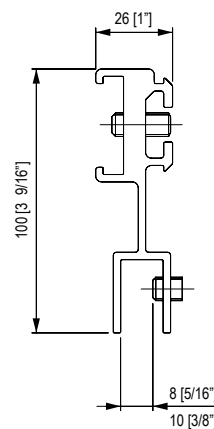

BS40

- Binario Slak L = 2/3/5 mt.
- Vía "Slak" L = 2/3/5 mt.
- Slak rail L = 2/3/5 mt.
- Schiene Slak L = 2/3/5 mt.
- Rail Slak L = 2/3/5 m.

Il binario ha una foratura con passo standard. In caso di taglio potrebbe essere necessario eseguire una foratura ad hoc.

La vía tiene un agujeros de "paso" estándar. Cuando corte, deba ejecutar una perforación especial.

The rail has holes with standard spacing. In case of cut, it could be necessary to realize holes ad hoc.

Die Schiene hat Bohrung mit Standardstand. Im Fall von Schnitt könnte es notwendig sein, eine Bohrung ad hoc zu realisieren.

Le rail Slak dispose de trous dont les espaces sont standards. En cas de coupe, il sera peut être nécessaire d'effectuer de nouveaux trous.

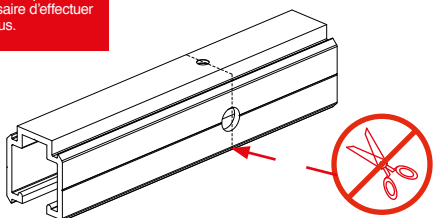
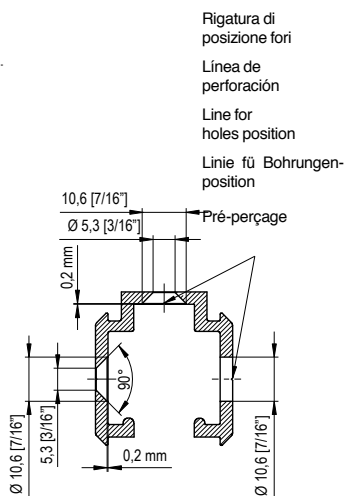

Evitare di accorciare la barra in prossimità dei fori - No acorte la barra cerca de los agujeros. - Avoid to make the bar shorter near the holes - Die Schiene in der Nähe der Bohrungen nicht abkürzen - Éviter de raccourcir la barre à proximité des trous

BS46

- Veletta Slak L = 2/3/5 mt.
- Charter "Slak" L = 2/3/5 mt.
- Slak spandrel panel L = 2/3/5 mt.
- Anlauf Slak L = 2/3/5 mt.
- Capot d'habillage Slak L = 2/3/5 m.

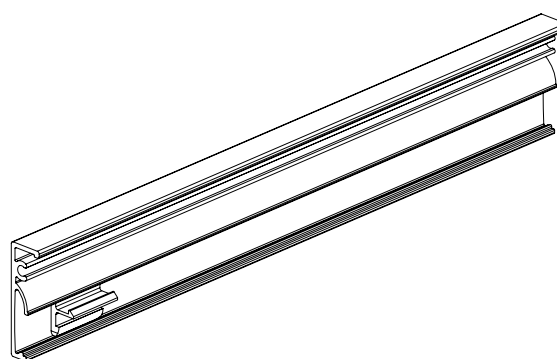
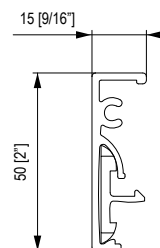

BS66

- Coppia tappi laterali Slak-2.
- Pareja de tapas laterales Slak-2.
- Slak-2 double covers.
- Paar Deckel Slak-2.
- Double cache Slak-2.

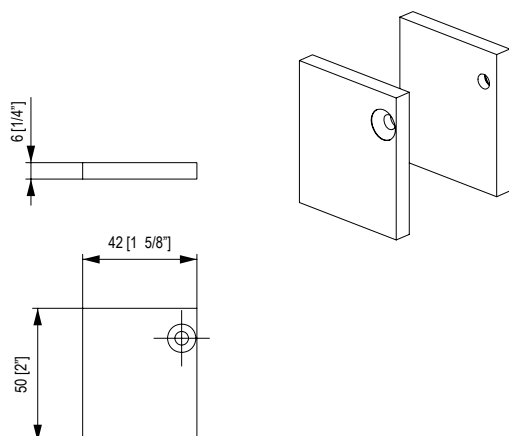

BS46 C

- Copriveletta per Slak-2 in acciaio inox L= 2,5 mt.
- Cobre charter para Slak-2 en acero. L= 2,5 mt.
- Stainless steel spandrel panel cover for Slak-2 L = 2,5 mt
- Anlaufabdeckung aus Edelstahl für Slak-2 L = 2,5 mt
- Capot d'habillage en inox pour Slak-2 L=2.5 m.

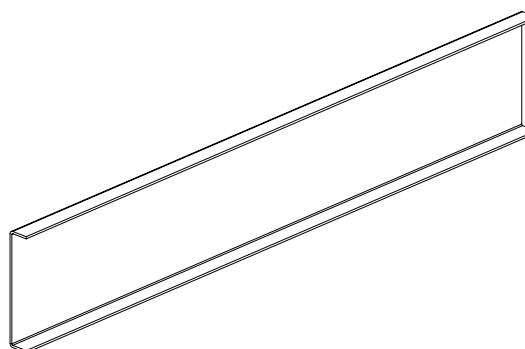
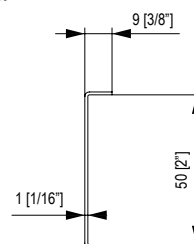

scorrevoli / sliding

system **SLAK T**

Alluminio / Aluminium - finiture / colors 02

Sistema scorrevole con binario a due vie che permette lo scorrimento parallelo a trascinamento, sia in apertura che in chiusura, di 2 ante mobili per parte. La veletta racchiude un meccanismo robusto che supporta applicazioni a muro e a soffitto in quattro varianti.

Sistema corredado con carril de dos vías que permite el deslizamiento paralelo, tanto en la apertura como el cierre de las dos puertas. La tapa esconde un mecanismo robusto que soporta fijaciones a pared y al techo en cuatro variantes.

Sliding system with 2-way rail which allows parallel sliding of 2 moving doors, both while opening and closing. The cover panel holds a robust mechanism that supports wall and ceiling applications in 4 versions.

Schiebesystem mit zweiwegiger Schiene, das das Parallelmitnahmeschieben von 2 Flügeltüren auf jeder Seite erlaubt, sowohl beim Öffnen als auch beim Schließen. Der Anlauf enthält einen robusten Mechanismus, der Wand- und Deckenanwendungen in 4 Varianten erlaubt.

Le système coulissant est composé d'un rail double, qui permet le mouvement simultané de deux portes vitrées. Le système intègre un mécanisme robuste, permettant une installation en applique ou au plafond dans 4 versions différentes.



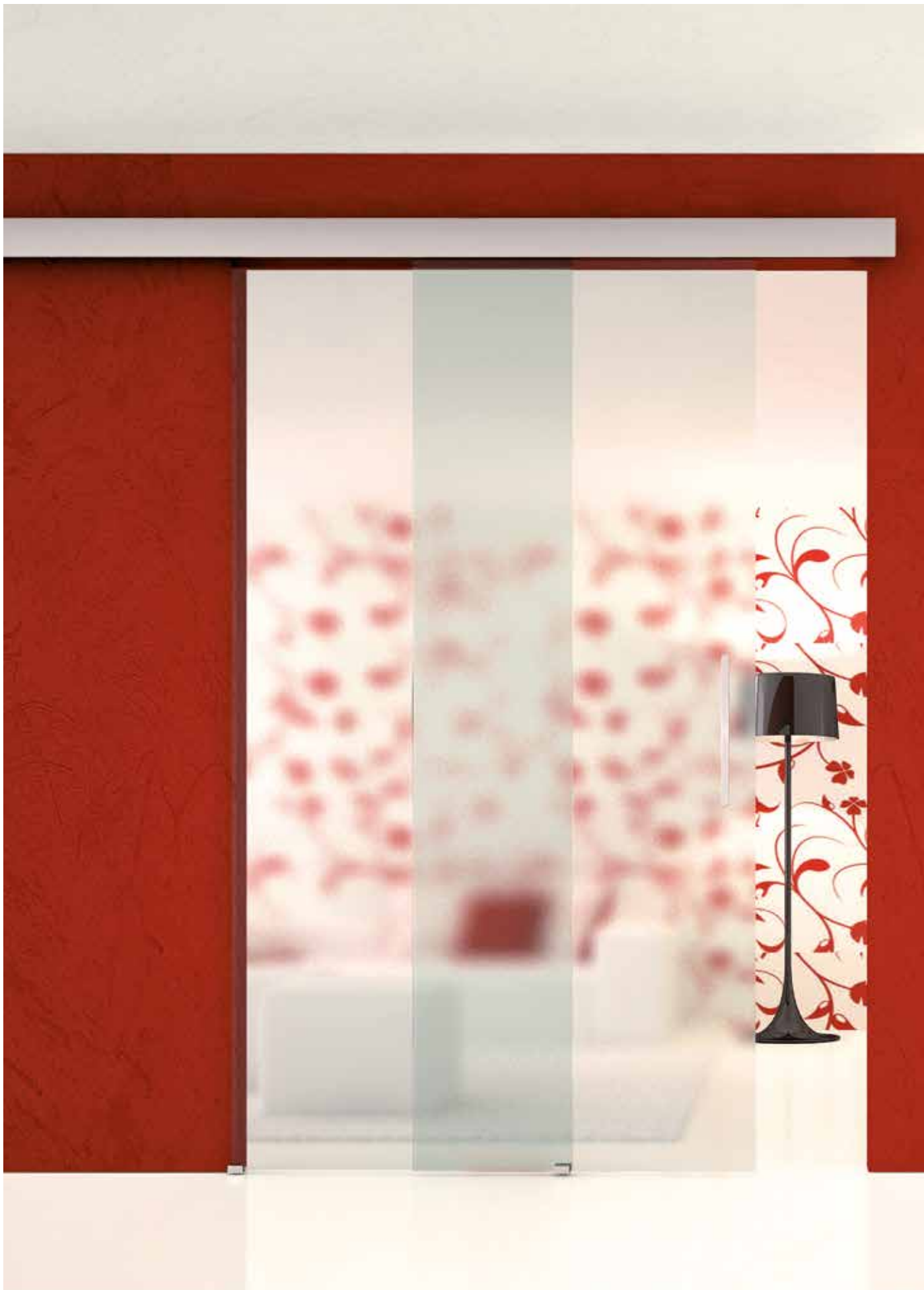

Slak-T SYSTEM

APPLICAZIONI - APLICACIÓN - APPLICATIONS - ANWENDUNGEN - APPLICATIONS

B05E52

Versione a parete/soffitto - 2 ante mobili - Versión de pared/techo. 2 puertas correderas
Wall/ceiling version. 2 moving glazings - Wand-,Deckevariante. 2 beweglichen Türflügel
Version mur/plafond - 2 verres mobiles

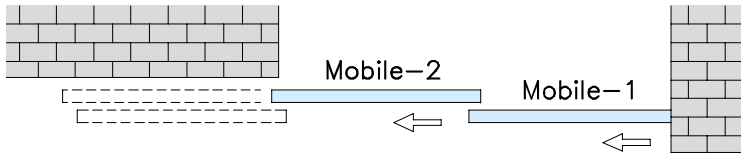

Parete - Pared - Wall - Wand - Mur



Parete/soffitto - Pared/techo - Wall/ceiling
Wand-,Decke - mur/plafond



B05E54

Versione a parete/soffitto - 4 ante mobili - Versión de pared/techo. 4 puertas correderas
Wall/ceiling version. 4 moving glazings - Wand-,Deckevariante. 4 beweglichen Türflügel
Version mur/plafond - 4 verres mobiles



Parete - Pared - Wall - Wand - Mur



Parete/soffitto - Pared/techo - Wall/ceiling
Wand-,Decke - mur/plafond



B05E73

Versione a soffitto. 3 ante : 2 mobili e 1 fissa - Versión de techo. 3 puertas: dos correderas y una fija
- Ceiling version. 3 glazings: 2 moving and 1 fixed - Deckevariante. 3 Türflügel: 2 beweglich und 1 fest -
Version plafond. 3 vantaux : 2 mobiles et 1 fixe

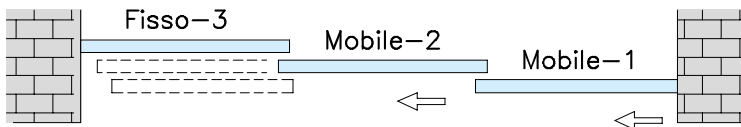

Soffitto - Techo - Ceiling - Decke - Plafond



B05E76

Versione a soffitto. 6 ante : 4 mobili e 2 fisse - Versión de techo. Seis puertas: 4 correderas y dos fijas - Ceiling version. 6 glazings: 4 moving and 2 fixed - Deckevariante. 6 Türflügel: 4 beweglich und 2 feste - Version plafond. 6 vantaux : 4 mobiles et 2 fixes



Soffitto - Techo - Ceiling - Decke - Plafond



B05E52 - B05E54

Parete/soffitto - Pared/techo Wall/ceiling
Wand-,Decke - mur/plafond

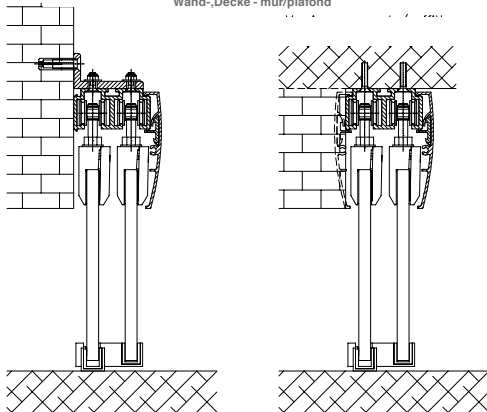

B05E73 - B05E76

Soffitto - Techo - Ceiling
Decke - Plafond

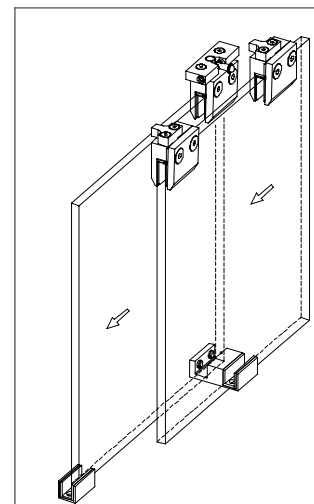
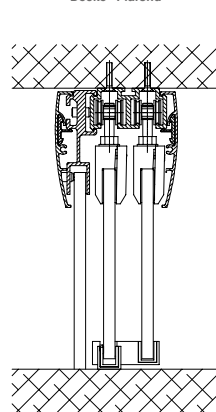

B05E52



- Set Slak-T scorrevole telescopico. Versione a soffitto/parete. 2 ante mobili.
- kit slak-t telescópico – corredero. Versión de techo/pared. Dos puertas correderas
- Slak-T set. Telescopic sliding. Ceiling/wall version. 2 moving glazings.
- Set Slak-T. Teleskopisches Schiebeseystem. Decke-,Wandvariante. 2 beweglichen Türflügel.
- Kit Slak-T coulissant télescopique. Version plafond/mur. 2 vantaux.

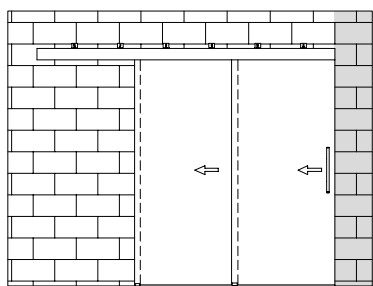

Compreso

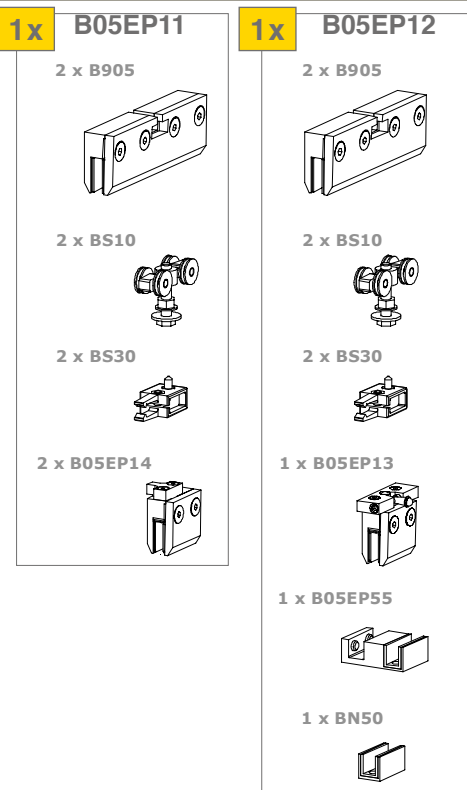

Included

Non compreso

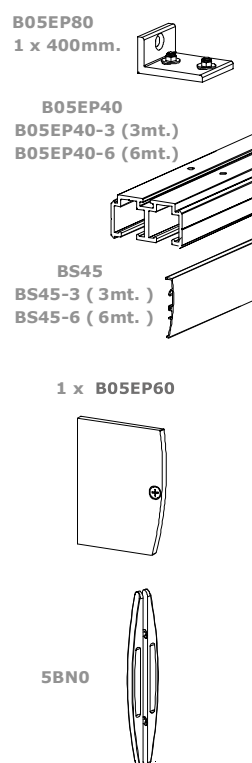

Not included

B05E54



- Set Slak-T scorrevole telescopico. Versione a soffitto/parete. 4 ante mobili.
- kit slak-t telescópico – corredero. Versión de techo/pared. Cuatro puertas correderas
- Slak-T set. Telescopic sliding. Ceiling/wall version. 4 moving glazings.
- Set Slak-T. Teleskopisches Schiebeseystem. Decke-,Wandvariante. 4 beweglichen Türflügel.
- Kit Slak-T coulissant télescopique. Version plafond/mur. 4 vantaux.

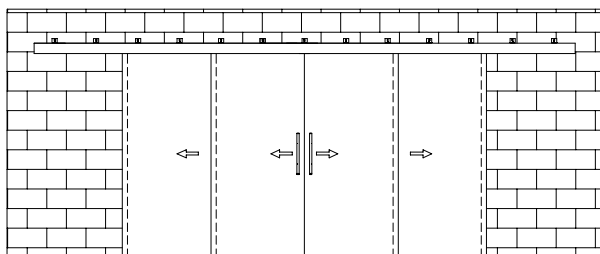

Compreso

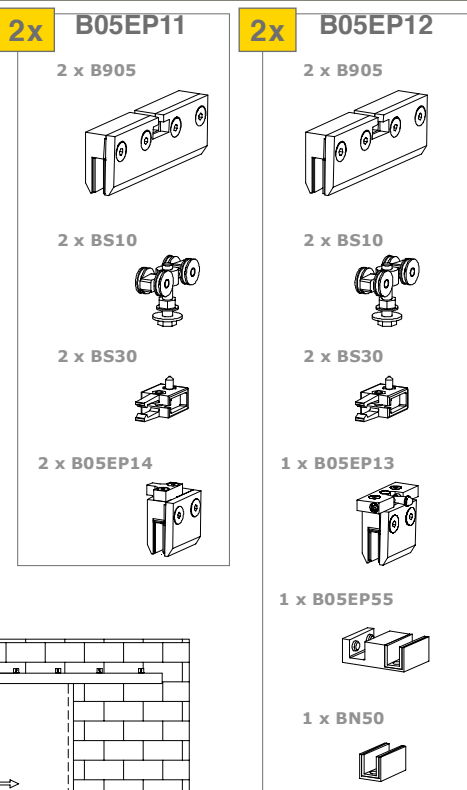

Included

Non compreso

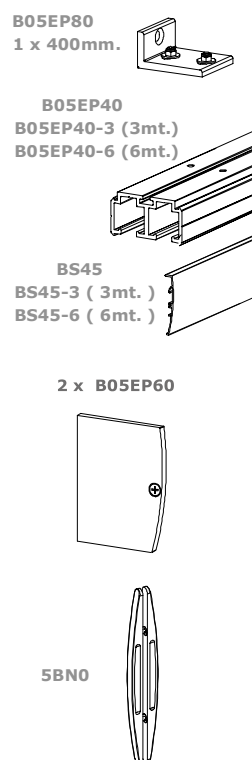

Not included

B05E73

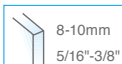

- Set Slak-T scorrevole telescopico. Versione a soffitto. 3 ante: 2 mobili e 1 fissa.
- kit slak-t telescópico – corredero. Versión de techo. Tres puertas: dos correderas y una fija
- Slak-T set. Telescopic sliding. Ceiling version. 3 glazings: 2 moving and 1 fixed.
- Set Slak-T. Teleskopisches Schiebeselement. Deckevariante. 3 Türflügel: 2 beweglich und 1 fest
- Kit Slak-T coulissant télescopique. Version plafond. 3 vantaux: 2 mobiles et un fixe.

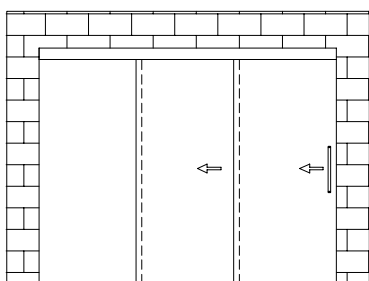

Compreso

1x

B05EP11

2 x B905

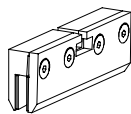

2 x BS10



2 x BS30



2 x B05EP14



1x

B05EP12

2 x B905

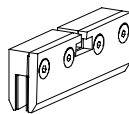

2 x BS10



2 x BS30



1 x B05EP13



1 x B05EP55



1 x BN50



Included

Non compreso

B05EP40
B05EP40-3 (3mt.)
B05EP40-6 (6mt.)

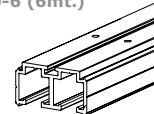

BS45
BS45-3 (3mt.)
BS45-6 (6mt.)

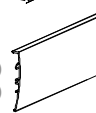

3 x BS70

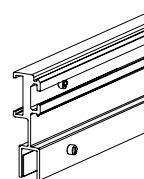

5BN0



Not included

B05E76



- Set Slak-T scorrevole telescopico. Versione a soffitto. 6 ante: 4 mobili e 2 fisse.
- kit slak-t telescópico – corredero. Versión de techo. Seis puertas: cuatro correderas y dos fijas
- Slak-T set. Telescopic sliding. Ceiling version. 6 glazings: 4 moving and 2 fixed.
- Set Slak-T. Teleskopisches Schiebeselement. Deckevariante. 6 Türflügel: 4 beweglich und 2 feste.
- Kit Slak-T coulissant télescopique. Version plafond. 6 vantaux: 4 mobiles et 2 fixes.

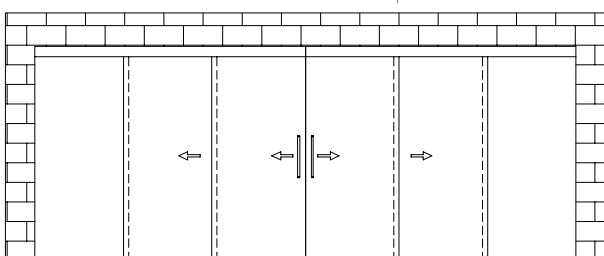

Compreso

2x

2 x B905

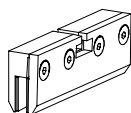

2 x BS10



2 x BS30



2 x B05EP14



2x

2 x B905

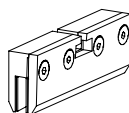

2 x BS10



2 x BS30



1 x B05EP13



1 x B05EP55



1 x BN50



Included

Non compreso

B05EP40
B05EP40-3 (3mt.)
B05EP40-6 (6mt.)

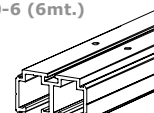

BS45
BS45-3 (3mt.)
BS45-6 (6mt.)



5 x BS70

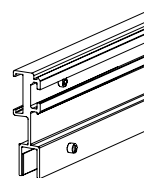

5BN0



Not included

B05EP40

- Binario a 2 vie L = 3/6 mt.
- Binario de dos vias L = 3/6 mt.
- 2-ways rail L = 3/6 mt.
- 2-wege Schiene L = 3/6 mt.
- Rail double L=3/6 m.

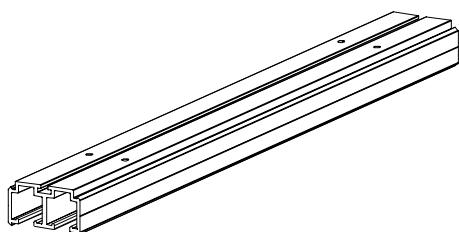
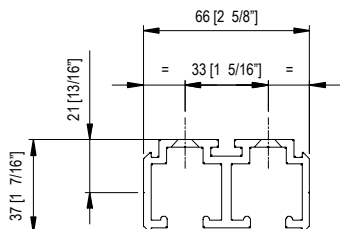

$$L \text{ barra} = L \text{ vano} + 100 + \left(\frac{L \text{ vano}}{n^\circ \text{ vetri}} \right)$$

$$L \text{ bar} = L \text{ space} + 100 + \left(\frac{L \text{ space}}{n^\circ \text{ glasses}} \right)$$

BS45

- Velella Slak L = 3/6 mt.
- Cárter "Slak" L = 3/6 mt.
- Slak spandrel panel. L = 3/6 mt.
- Anlauf Slak. L = 3/6 mt.
- Capot d'habillage Slak L=3/6 m.

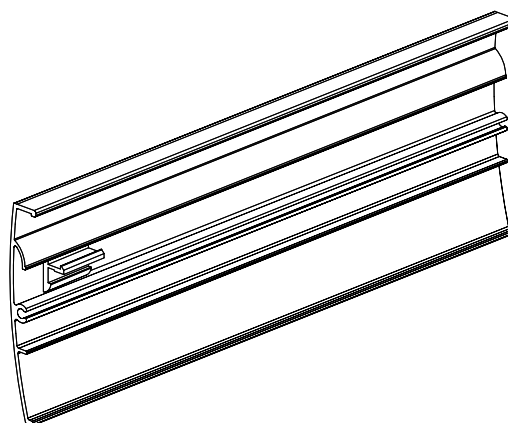
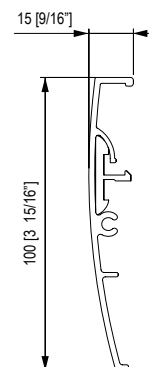

B05EP60

- Tappo binario a due vie.
- Tapa por carril de dos vias.
- Cap for 2-ways rail.
- Deckel für 2-wege Schiene.
- Capot extrémité Slak-T.

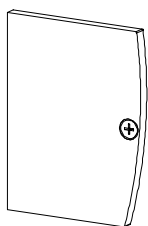
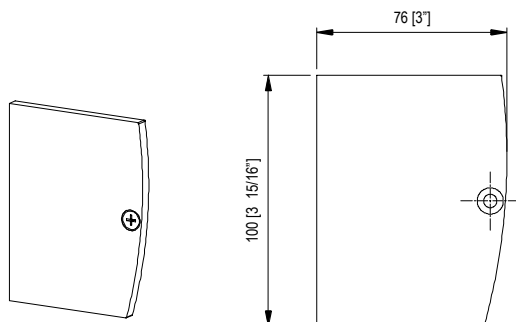
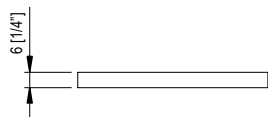

BS70

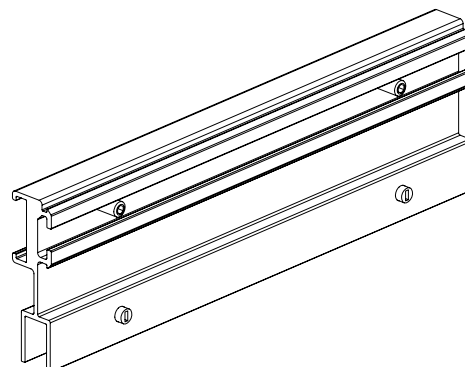
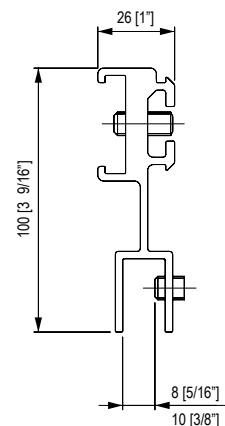

- Supporto Slak per vetro fisso L=300mm.
- Soporte Slak para vidrio fijo L=300mm.
- Slak support for fixed glass. L=300mm.
- Slak Schiene für feste Gehäuse L=300mm.
- Support Slak pour verre fixe L=300mm.





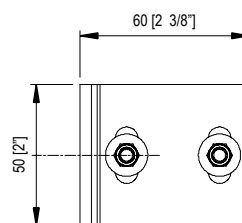
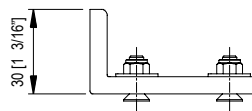
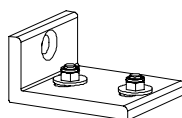

B05EP80

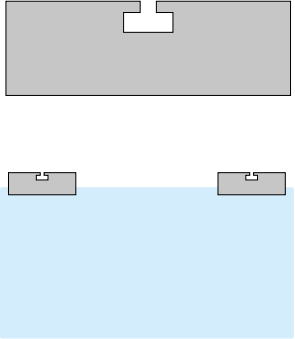
- Staffa di fissaggio a parete. Una ogni 400mm.
- Abrazadera de ajuste a pared. Una pieza, cada 400mm.
- Wall fixing plate. One each 400mm.
- Wandbefestigungsplatte. Eine jede 400mm.
- Plaque de fixation apparente. Une tous les 400 mm.

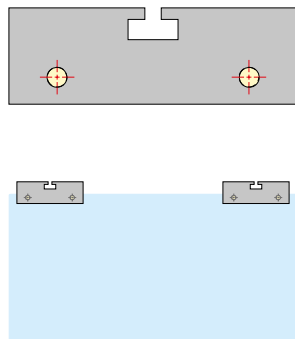

 1000 mm 39.37"	 75 Kg MAX 165 lbs
B905 STANDARD	
	

 1000-1200 mm 39.37" to 47.24"	 120 Kg MAX 264 lbs
B905 + OPTIONALS	
	

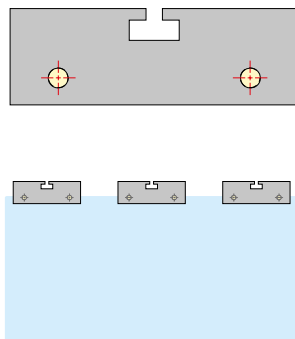
 >1200 mm >47.24"	 >120 Kg MAX >264 lbs
+N B905 + OPTIONALS	
	

B05E52

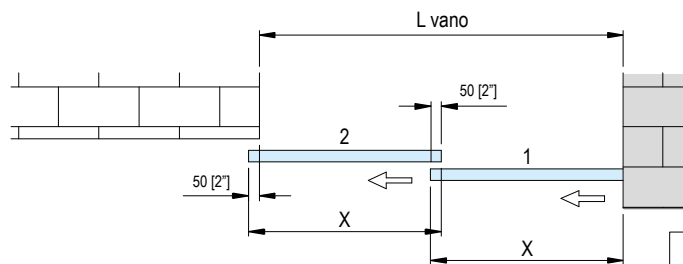
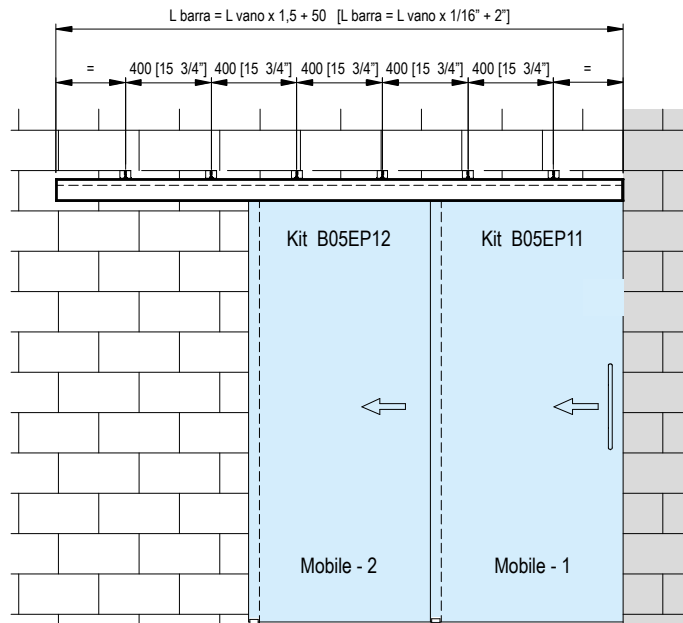

$X = (L \text{ vano} : 2) + 50$
 $[X = (L \text{ vano} : 2) + 2'']$

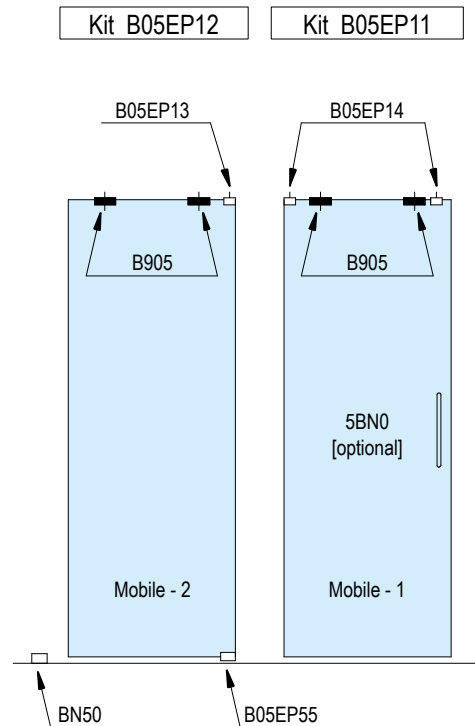
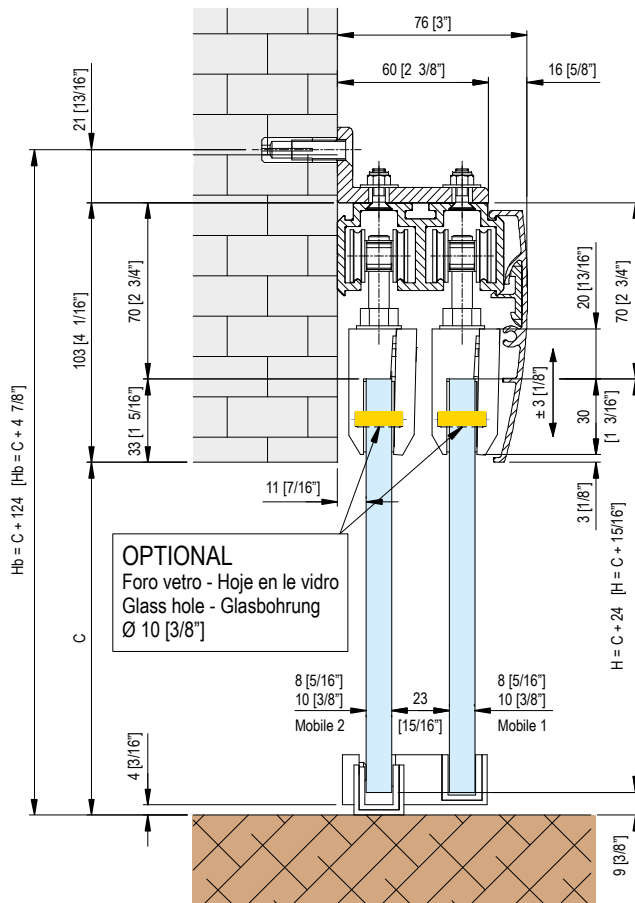

B05E54

In caso di dimensioni della barra superiore a 6mt. utilizzare due barre
 In case of bar dimensions higher than 6mt. use 2 bars

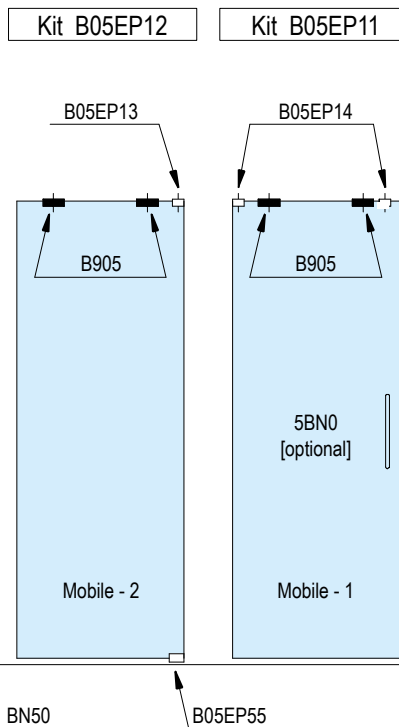
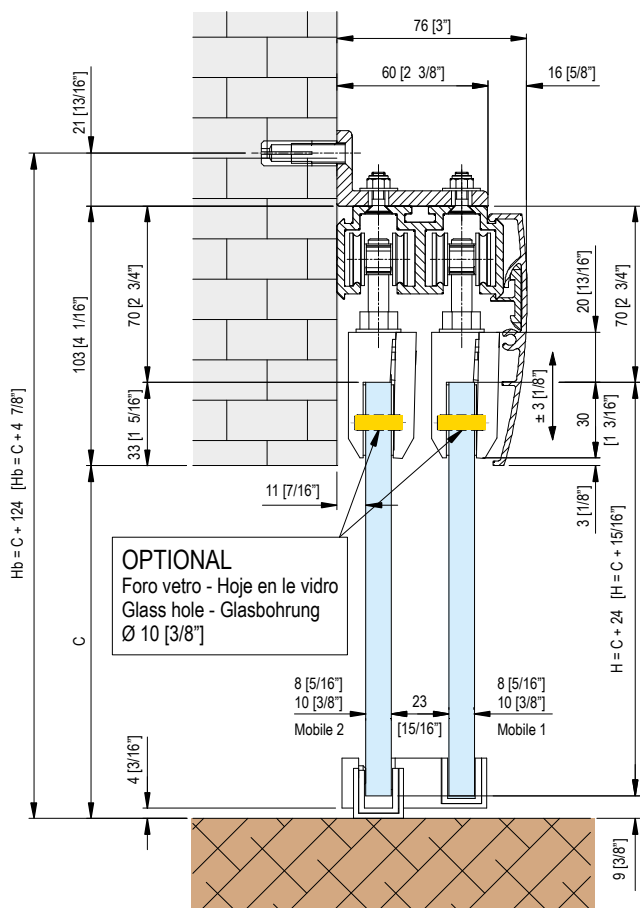
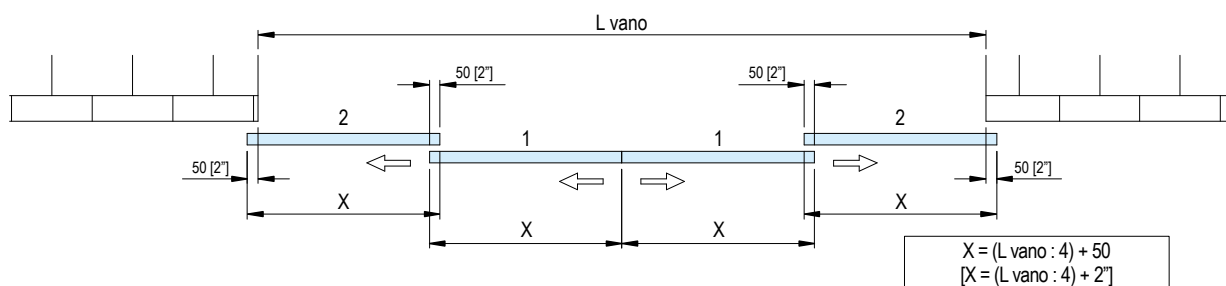
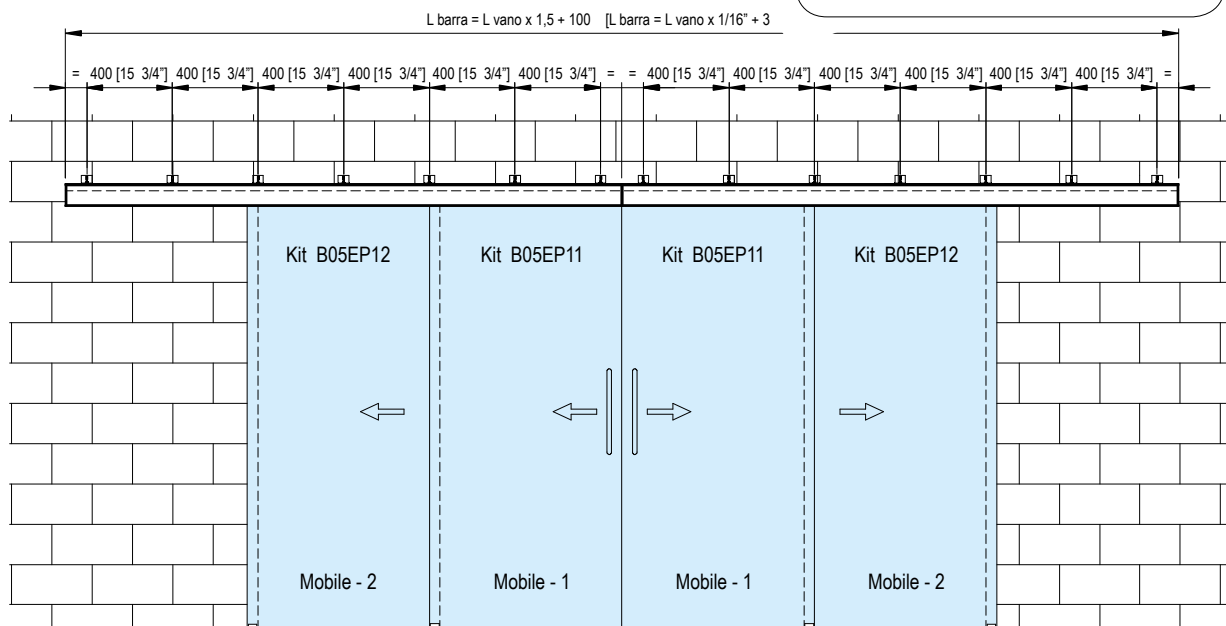

B05E73

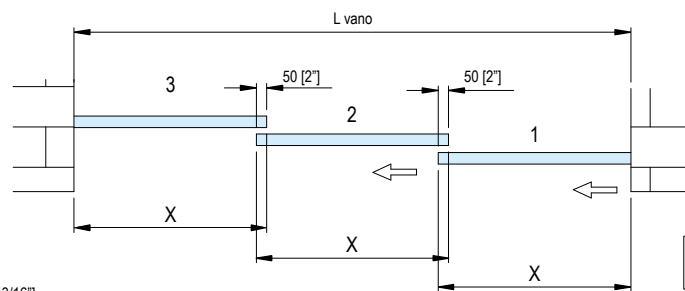
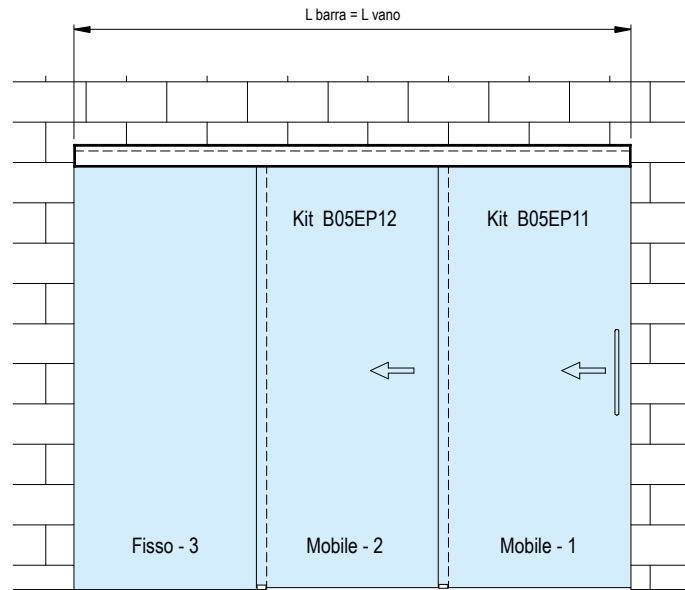

$$X = (L \text{ vano} : 3) + 33$$

$$[X = (L \text{ vano} : 3) + 1 \frac{5}{16}"]$$

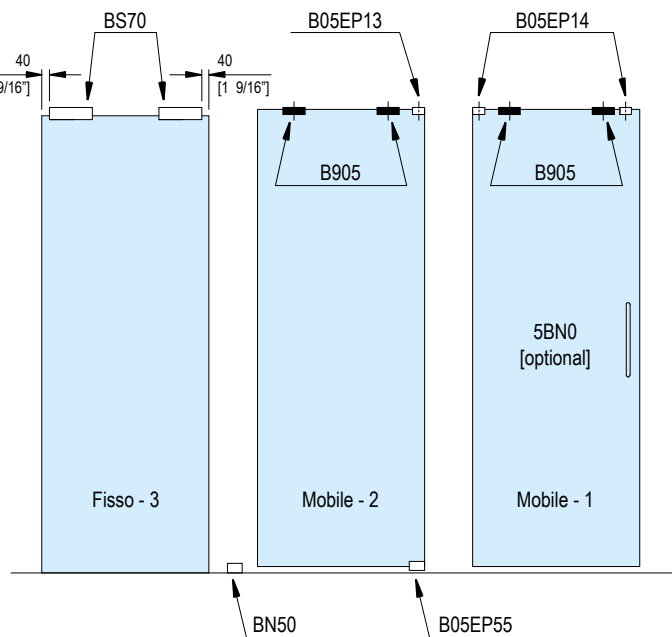
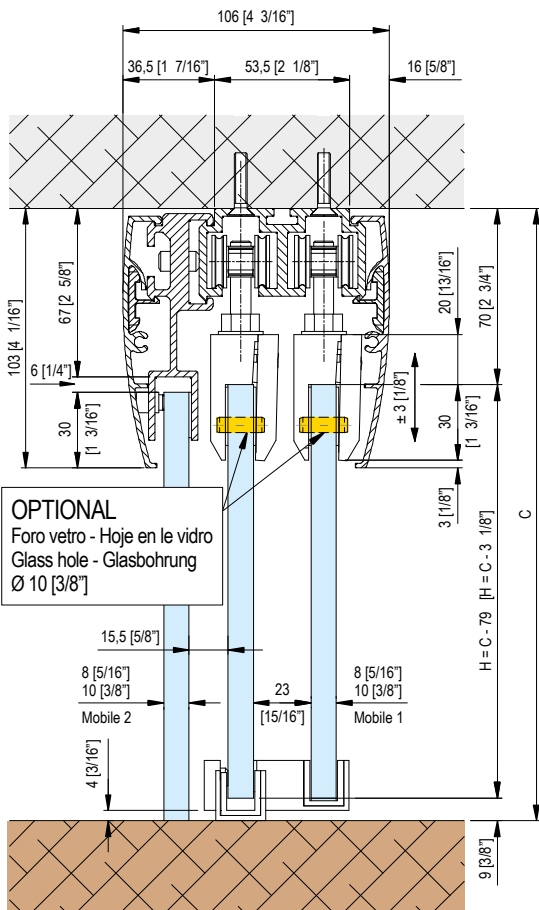

B05E76

In caso di dimensioni della barra superiore a 6mt. utilizzare due barre
 In case of bar dimensions higher than 6mt. use 2 bars

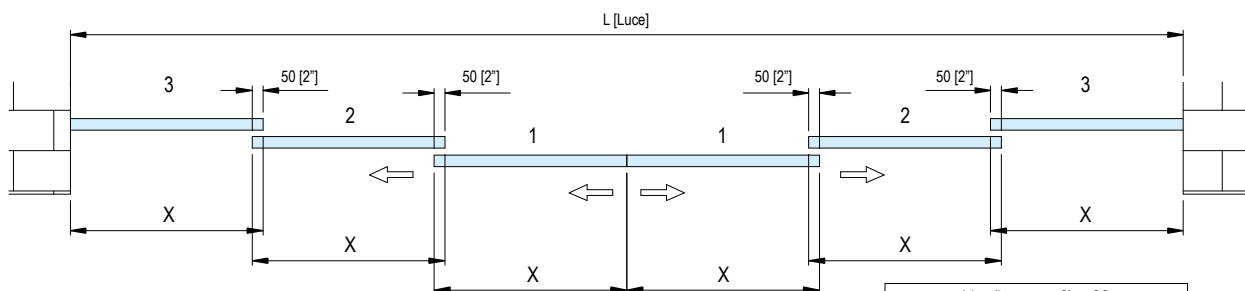
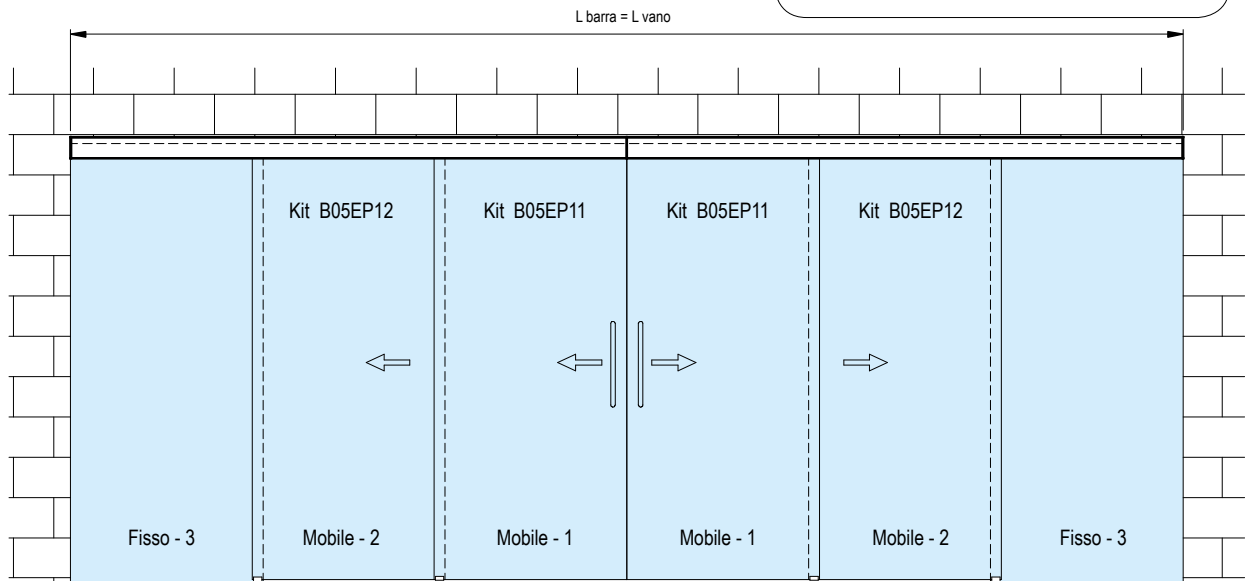

$$X = (L_{vano} : 6) + 33$$

$$[X = (L_{vano} : 6) + 1 \frac{5}{16}"]$$

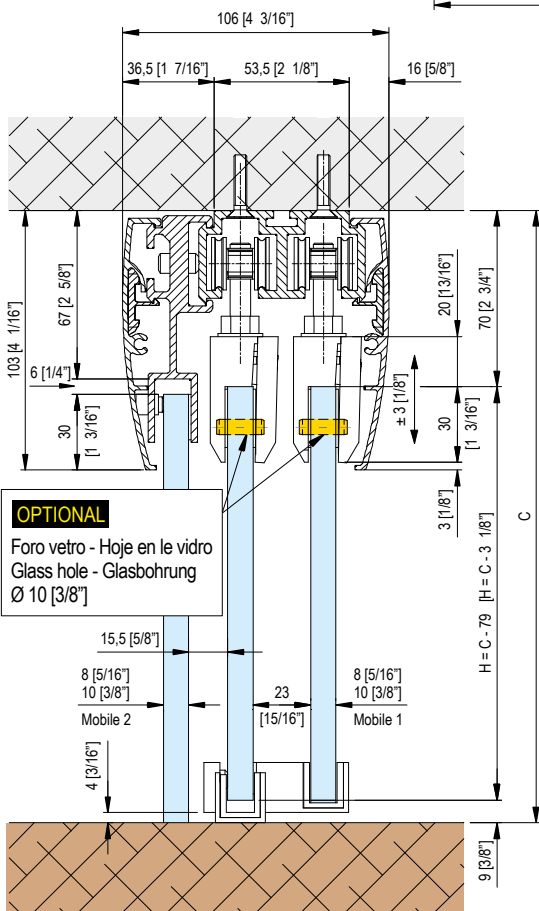

Kit B05EP12 Kit B05EP11

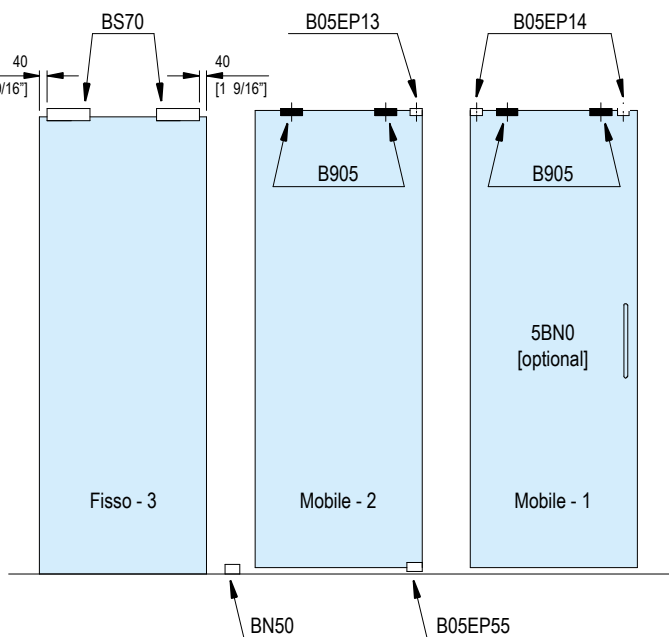

Slak-T B05E

DETTAGLI DETALLES DETAILS DETAILLE

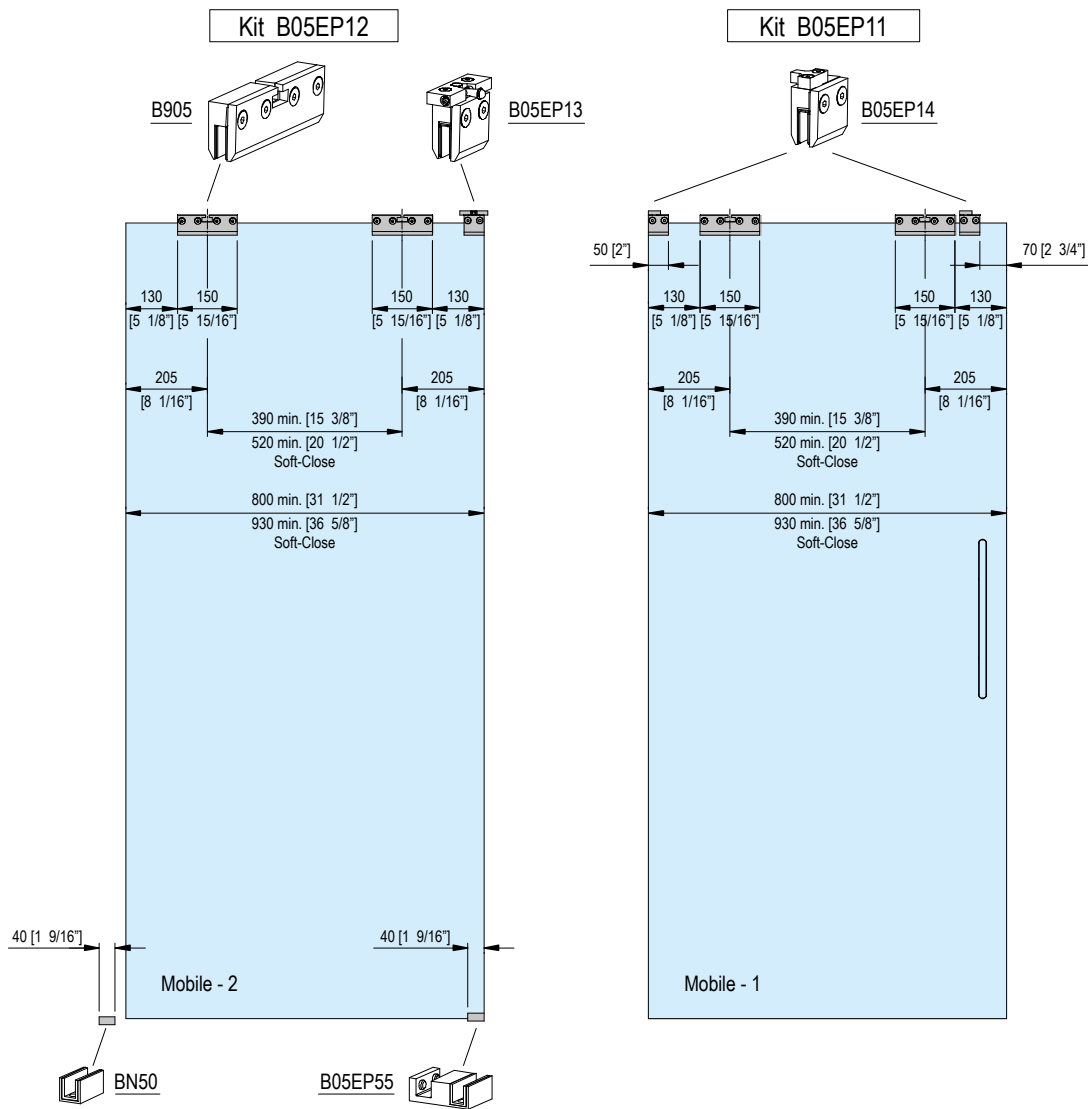

ESEMPIO - EJEMPLO EXAMPLE - BEISPIEL

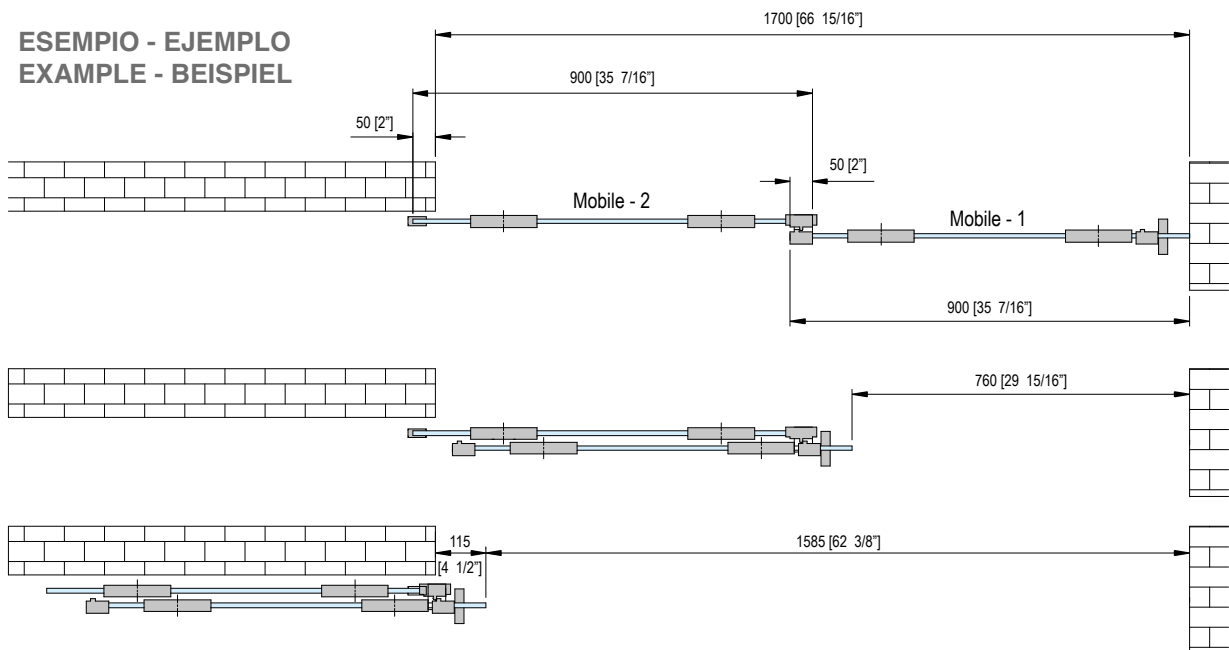

scorrevoli / sliding

system **Inox-Slide**

Acciaio Inox / Stainless Steel - finiture / colors 31

Completamente realizzato in acciaio inox in un ottimo rapporto qualità prezzo. È adatto ad una vasta gamma di contesti architettonici. Può essere fissato a muro oppure direttamente sul vetro ed è previsto ad anta singola oppure doppia anta.

Hecho totalmente en acero inoxidable en una relación calidad/precio excelente. Se pone interesante en un contexto arquitectónico moderno y en remodelación. Puede ser fijado a la pared o a vidrio; se prevehe uso con hoja simple o doble.

Completely made in stainless steel, it also has an excellent price-quality ratio. This slider is suitable for a wide range of architectural contexts, it may be fixed directly on the wall or on the glass and it was designed for single or double door.

Punktgehaltenes Schiebetürsystem aus Edelstahl mit Senkpunkt-haltern. Möglichkeit der Befestigung an Wand oder an Decke als einflügelige oder zweiflügelige Variante.

Entièrement conçu en inox, les coulissants bénéficient d'un excellent rapport qualité-prix. Les chariots de coulissant s'adaptent à tous les contextes architecturaux. Ils se fixent soit au mur soit sur paroi en verre, et sont conçus pour porte simple ou double.





BV00

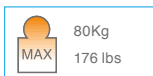
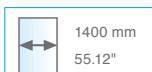
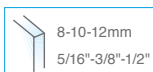

- Kit scorrevole ad un anta
- fissaggio su vetro .
- kit para una puerta corredera
y fijación en el vidrio.
- Sliding set – one glazing
fixing on glass.
- Set Schiebesystem mit einem
Flügel – Befestigung am Glas.
- Kit coulissant pour 1 vantail,
fixation sur verre.

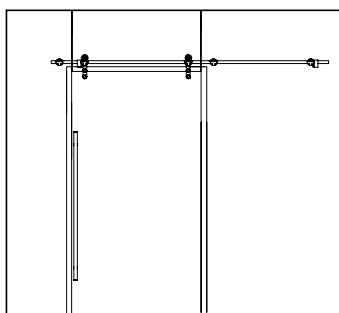

Compreso



2X BV10
PINZA PER VETRO
GRIP FOR GLASS

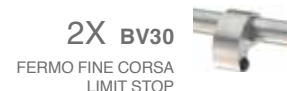

2X BV30
FERMO FINE CORSA
LIMIT STOP



1X BV40
BINARIO CON TAPPI DI CHIUSURA
TRACK WITH CLOSING PLUG
Ø 25mm L=3000mm
GRIP FOR GLASS



5X BV70
ATTACCO DEL
BINARIO A VETRO
ATTACHMENT OF THE
TRACK TO GLASS



1X BN50
GUIDA A TERRA
FLOOR GUIDE

Included

BV01

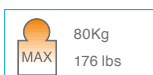
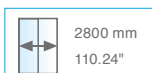
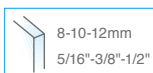

- Kit scorrevole a due ante
- fissaggio su vetro.
- Kit para dos puertas correderas
y fijación en el vidrio.
- Sliding set – on two glazing
fixing on glass.
- Set Schiebesystem mit zwei
Flügeln – Befestigung am Glas.
- Kit coulissant pour 2 vantaux,
fixation sur verre.

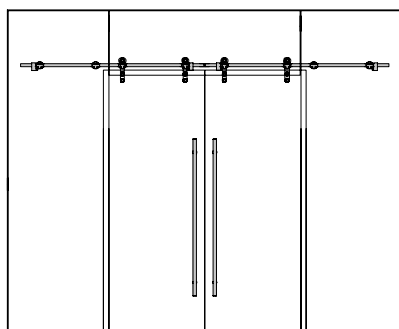

Compreso



4X BV10
PINZA PER VETRO
GRIP FOR GLASS



4X BV30
FERMO FINE CORSA
LIMIT STOP



2X BV40
BINARIO CON TAPPI DI CHIUSURA
TRACK WITH CLOSING PLUG
Ø 25mm L=3000mm
GRIP FOR GLASS

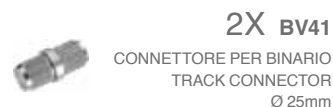

2X BV41
CONNETTORE PER BINARIO
TRACK CONNECTOR
Ø 25mm

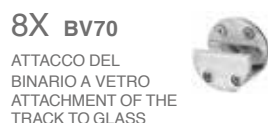

8X BV70
ATTACCO DEL
BINARIO A VETRO
ATTACHMENT OF THE
TRACK TO GLASS



2X BN50
GUIDA A TERRA
FLOOR GUIDE

Included

BV05

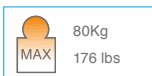
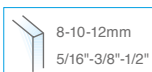

- Kit scorrevole ad un anta
- fissaggio a vetro con muro laterale.
- Kit para puerta corredera una puerta
- fijación vidrio con pared lateral.
- Sliding set – one glazing
fixing on glass with sideways wall.
- Set Schiebesystem mit einem Flügel
- Befestigung am Glas und seitliche Wand.
- Kit coulissant pour 1 vantail,
fixation sur mur.

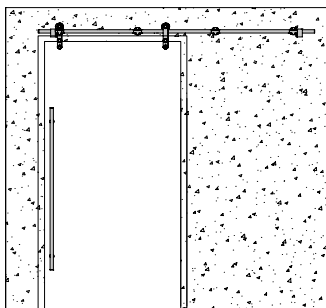

Compreso



2X BV10
PINZA PER VETRO
GRIP FOR GLASS

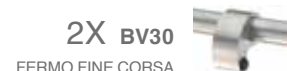

2X BV30
FERMO FINE CORSA
LIMIT STOP



1X BV40
BINARIO CON TAPPI DI CHIUSURA
TRACK WITH CLOSING PLUG
Ø 25mm L=3000mm
GRIP FOR GLASS



4X BV80
ATTACCO DEL
BINARIO A MURO
ATTACHMENT OF THE
TRACK TO WALL



1X BN50
GUIDA A TERRA
FLOOR GUIDE

Included

BV06

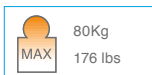
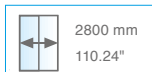
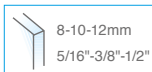

- Kit scorrevole ad un anta
- fissaggio su muro.
- Kit para una puerta corredera
y fijación en la pared.
- Sliding set
– one glazing fixing on wall.
- Set Schiebesystem mit einem
Flügel – Befestigung an der Wand.
- Kit coulissant pour 1 vantail,
fixation sur mur.

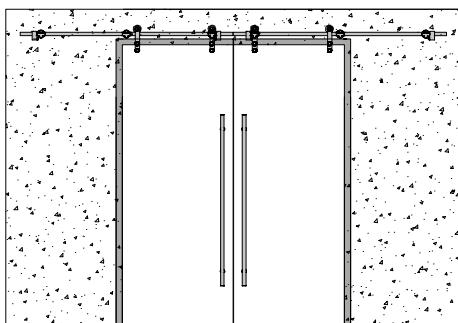

Compreso



4X BV10
PINZA PER VETRO
GRIP FOR GLASS

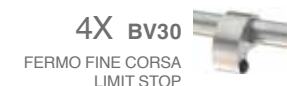

4X BV30
FERMO FINE CORSA
LIMIT STOP



2X BV40
BINARIO CON TAPPI DI CHIUSURA
TRACK WITH CLOSING PLUG
Ø 25mm L=3000mm
GRIP FOR GLASS

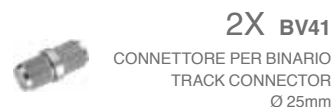

2X BV41
CONNETTORE PER BINARIO
TRACK CONNECTOR
Ø 25mm

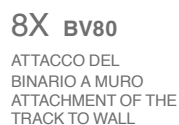

8X BV80
ATTACCO DEL
BINARIO A MURO
ATTACHMENT OF THE
TRACK TO WALL



2X BN50
GUIDA A TERRA
FLOOR GUIDE

Included

BV00

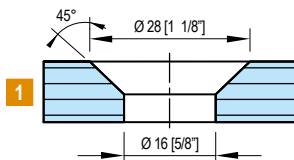
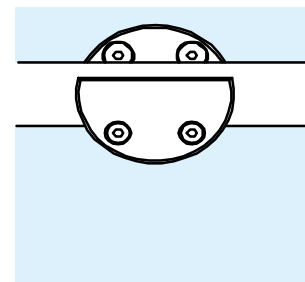
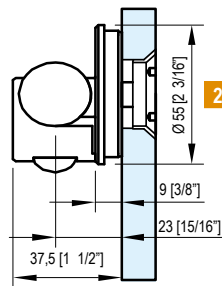
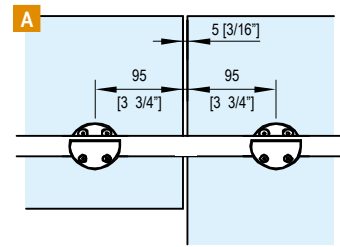
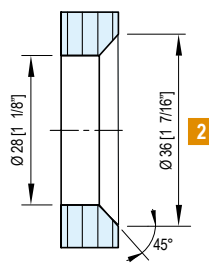
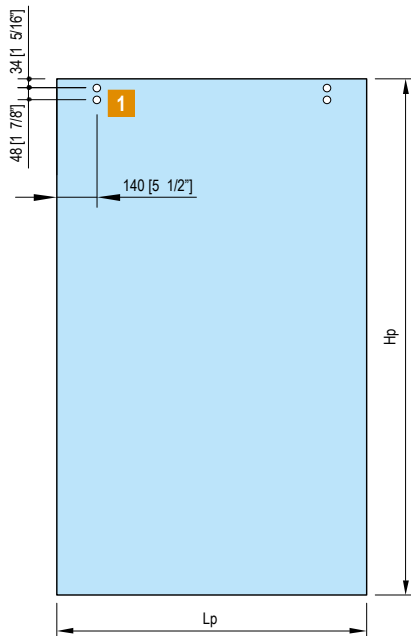
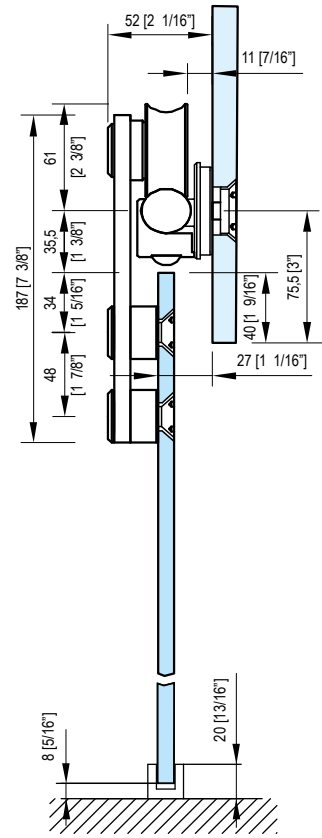
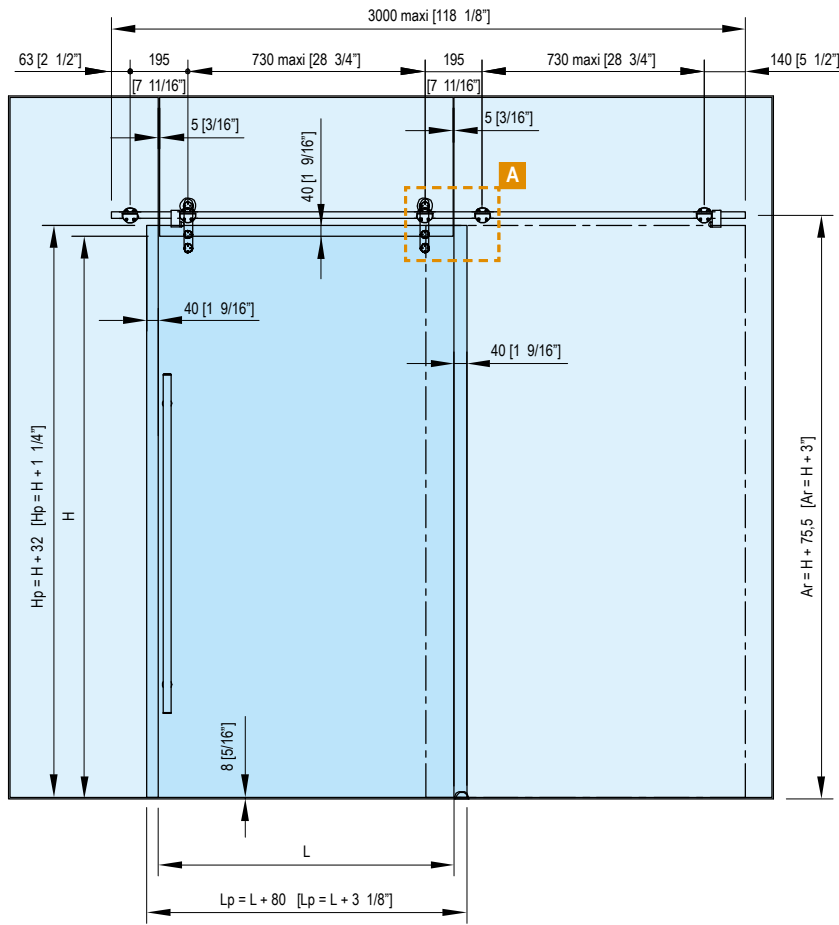

BV01

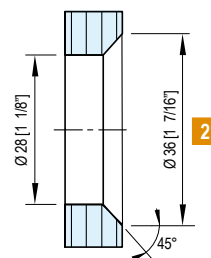
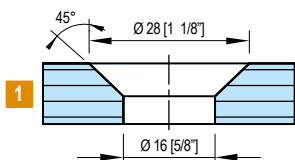
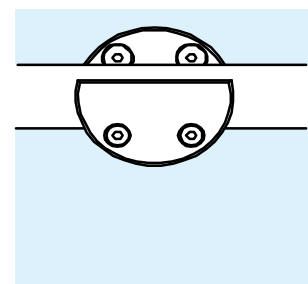
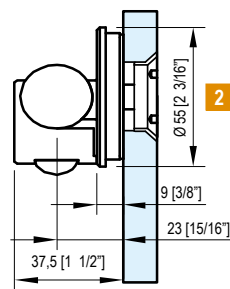
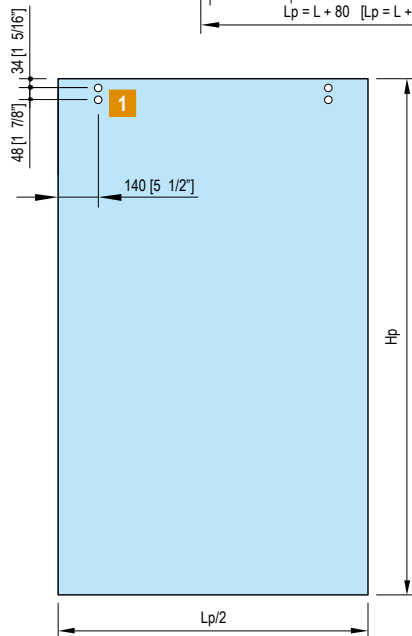
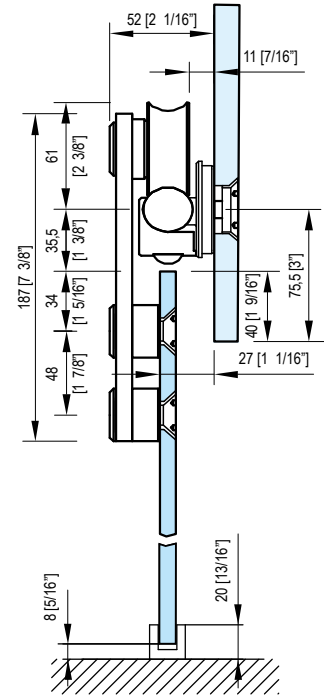
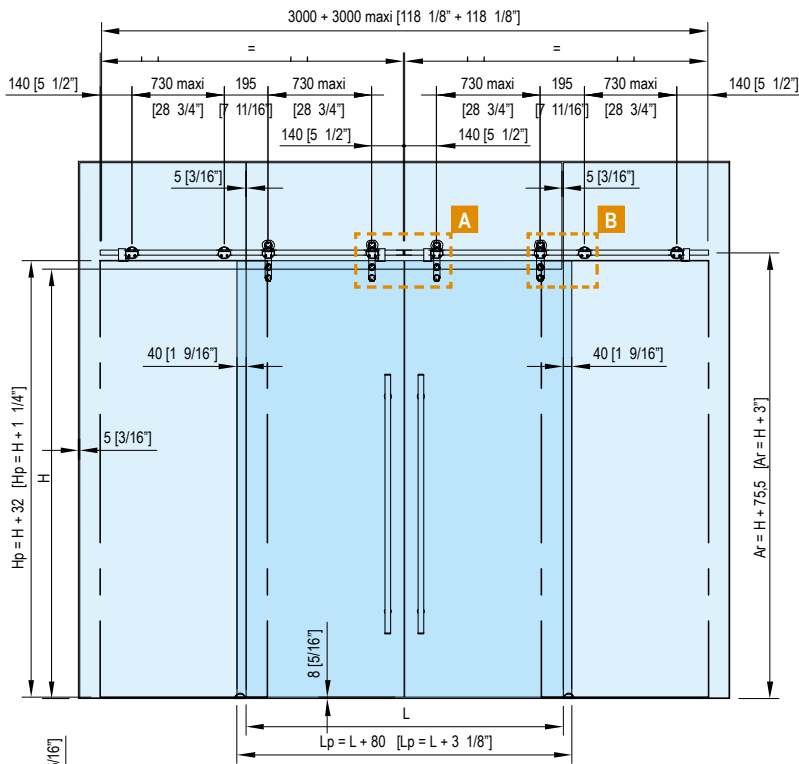
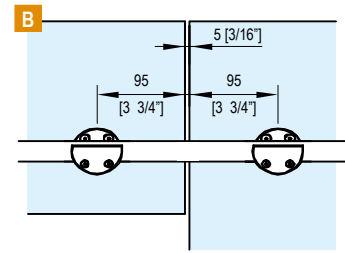
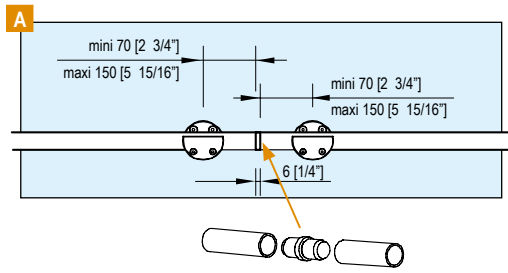

BV05

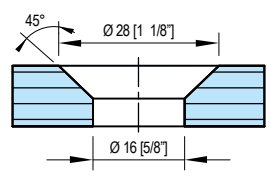
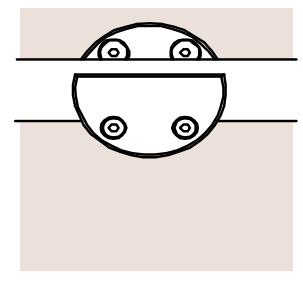
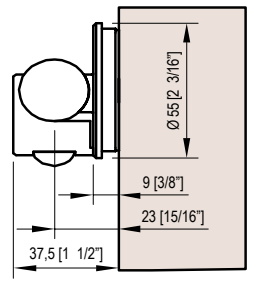
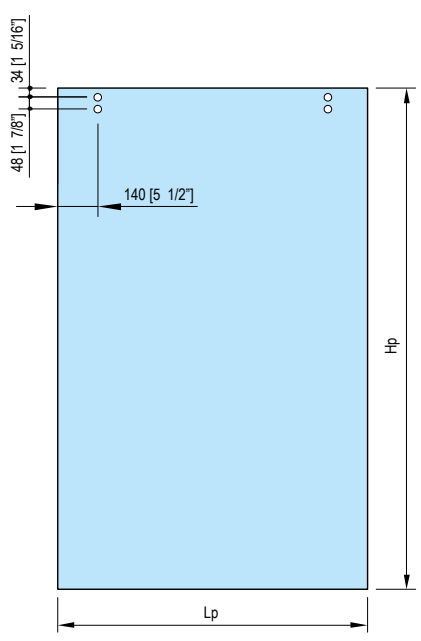
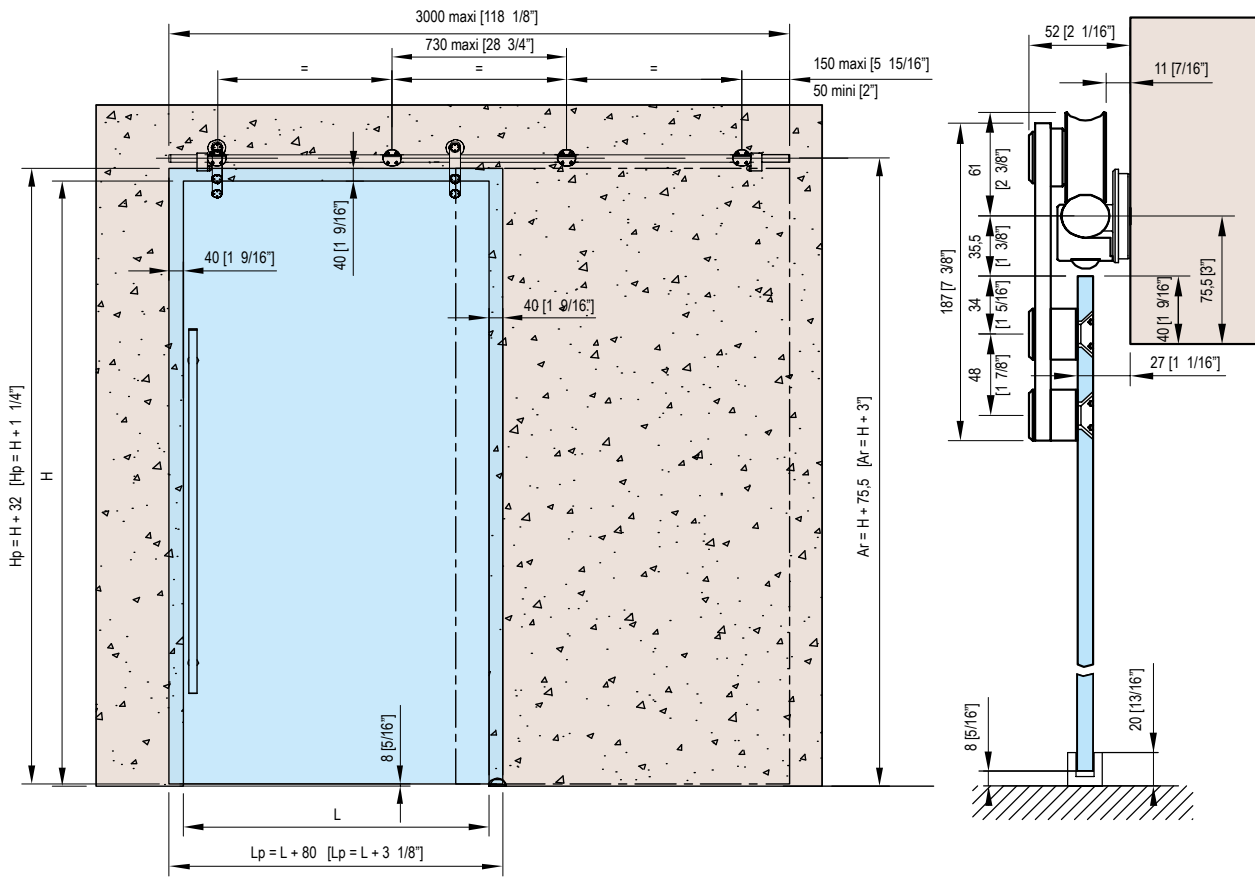

pinze e serrature / clamps and locks



B905



B925 finiture / colors 02-05
13-14-15-16-17-40



B92 finiture / colors 02-05
13-14-15-16-17-40



B94 finiture / colors 02-05
13-14-15-16-17-40



B95 finiture / colors 02-05
13-14-15-16-17-40



B96 finiture / colors 02-05
14-15-16-17-31-40



B97 finiture / colors 02-05
14-15-16-17-31-40

pomoli e maniglie / knobs and handles



5B01 finiture / colors
13-14-15-16-17



B93 finiture / colors 02-05
13-14-15-16-17-40



5B05 finiture / colors 02-05
13-14-15-16-17-40



5BN0 finiture / colors
13-14-15-40

meccanismi frenanti / braking mechanism



BS35 - soft-close

B905

- Pinza per porta scorrevole.
- Pinza de sujeción para puerta corredera.
- Clamp for sliding door.
- Band für Schiebetür.
- Pince pour porte coulissante.

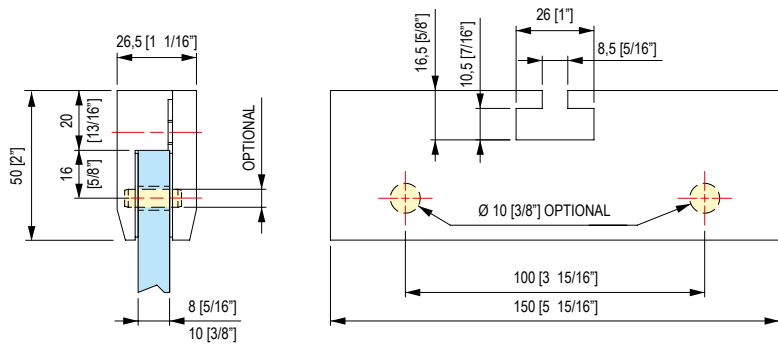

STANDARD

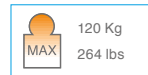
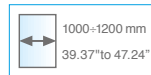
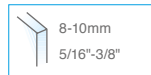
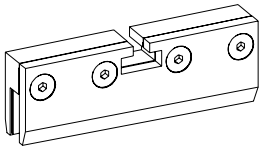

OPTIONAL

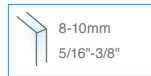

OPTIONAL +N B905

B925

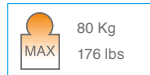
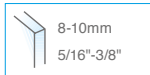

- Pinza per porta scorrevole.
- Pinza de sujeción para puerta corredera.
- Clamp for sliding door.
- Band für Schiebetüre.
- Pince pour porte coulissante.

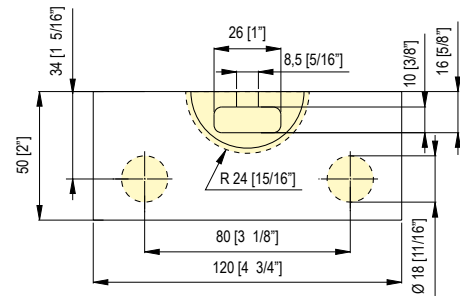
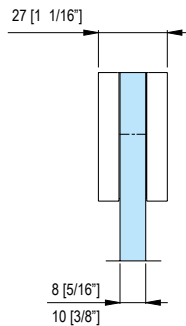
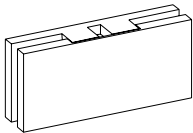

B92

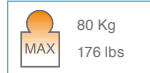

- Pinza per porta scorrevole.
Filetto 8mm (10mm a richiesta).
- Pinza de sujeción para puerta corredera.
Rosca de 8 mm (10 mm a petición).
- Clamp for sliding door.
8mm thread (10mm on request).
- Band für Schiebetür.
Gewinde 8mm (10mm auf Wunsch).
- Pince pour porte coulissante.
Taraudage M8 (M10 sur demande).

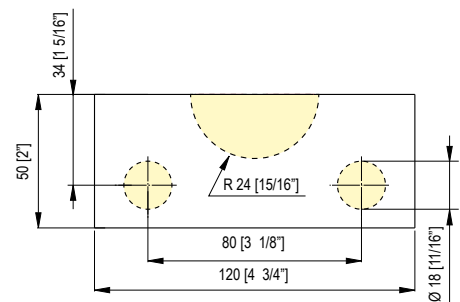
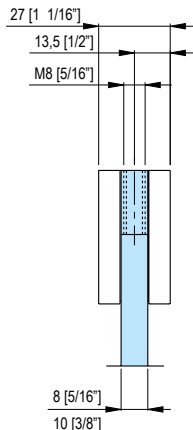
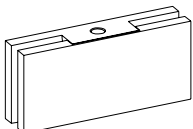

B94

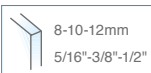

- Serratura con gancio per porta scorrevole.
- Cerradura con gancho para puerta corredera.
- Lock with hook for sliding door.
- Schloss mit Haken für Schiebetür.
- Serrure avec crochet pour porte coulissante.

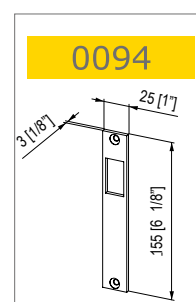
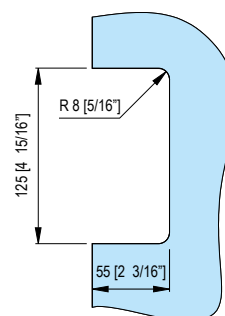
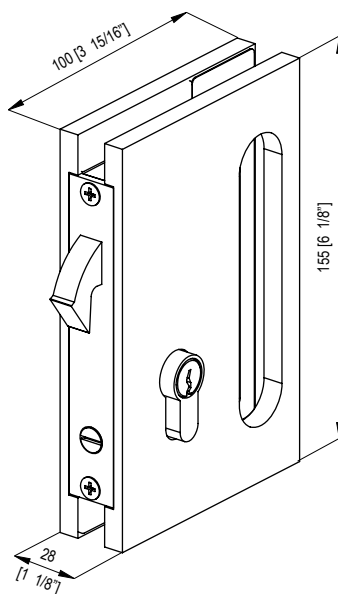
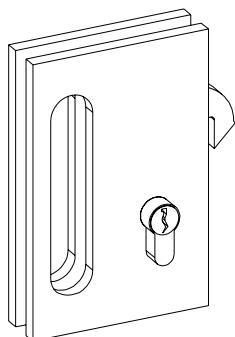

B95

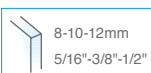

- Controserratura per porta scorrevole.
- Contra chapa para puerta corredera.
- Lock keeper for sliding door.
- Gegenschloss für Schiebetür.
- Gâche pour serrure de porte coulissante.

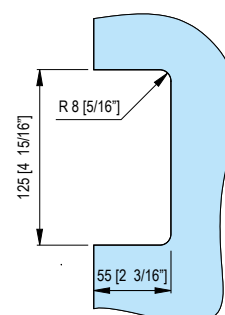
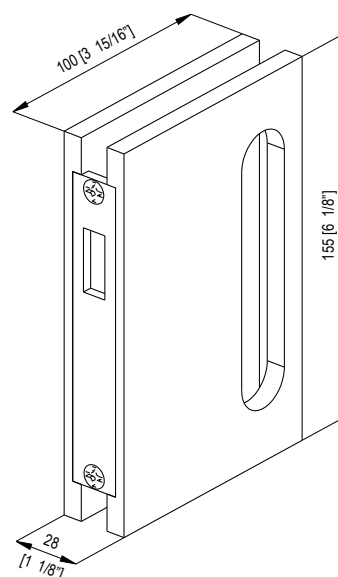
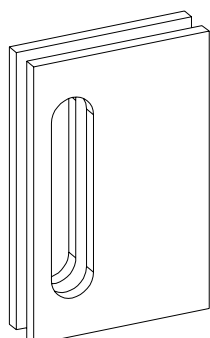

B96



- Serratura con gancho per porta scorrevole.
- Cerradura con gancho para puerta corredera.
- Lock with hook for sliding door.
- Schloss mit Haken für Schiebetür.
- Serrure avec crochet pour porte coulissante.

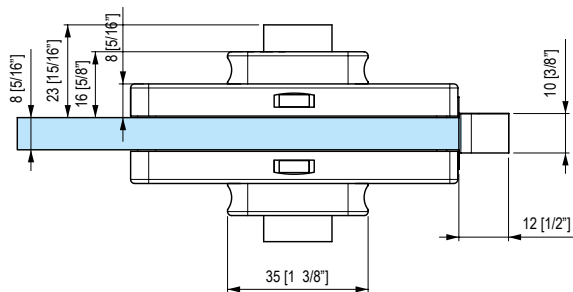
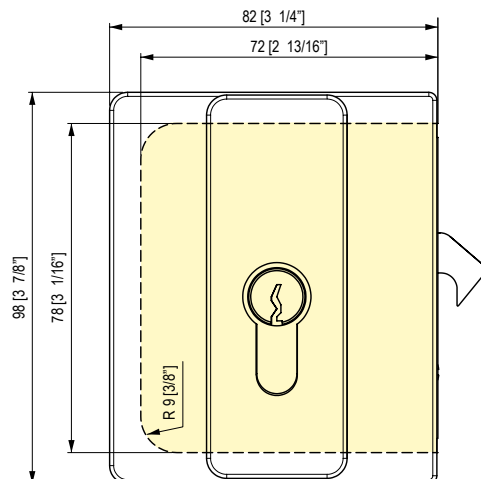
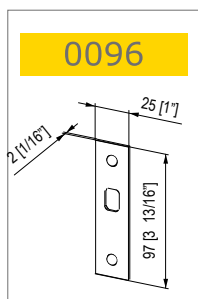
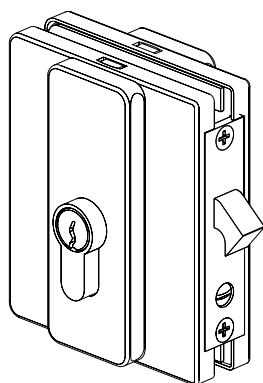

B97



- Controserratura per porta scorrevole.
- Contra chapa para puerta corredera.
- Lock keeper for sliding door.
- Gegenschloss für Schiebetür.
- Gâche pour serrure de porte coulissante.

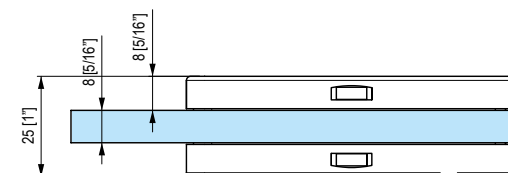
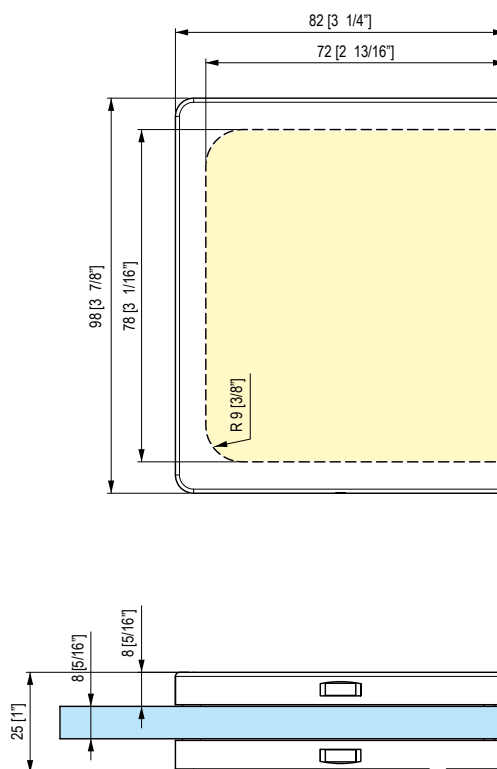
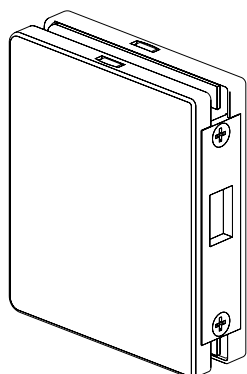

5B01



- Anello per porta scorrevole d. 40mm .
- Casquillo para puerta corredera d. 40mm .
- Sliding door ring diameter 40mm
- Ring für Schiebetür. Durchmesser 40mm.
- Poignée trou libre pour porte coulissante Ø40 mm.

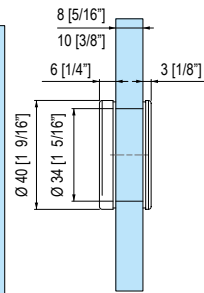
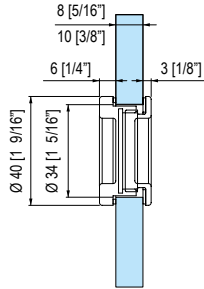
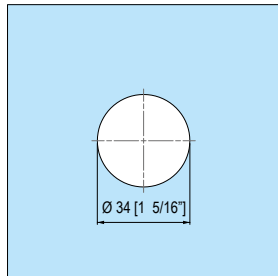
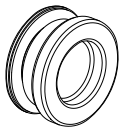

B93



- Maniglia per porta scorrevole.
- Tirador para puerta corredera.
- Small handle for sliding door.
- Kleine Handgriff für Schiebetür.
- Petite poignée pour porte coulissante.

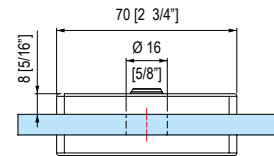
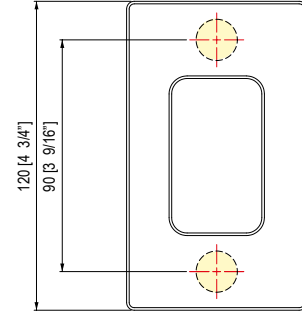
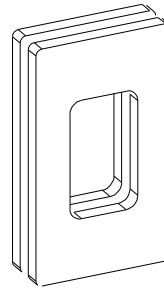

5B05

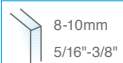

- Maniglia per porta scorrevole.
- Tirador para puerta corredera.
- Small handle for sliding door.
- Kleine Handgriff für Schiebetür.
- Petite poignée pour porte coulissante.

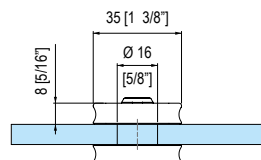
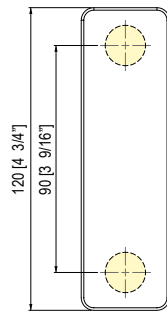
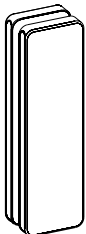

5BN0

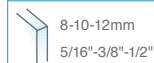

- Maniglia Neuscorre.
- Tirador "Neuscorre".
- Neuscorre handle.
- Neuscorre Türdrücker.
- Poignée Neuscorre.

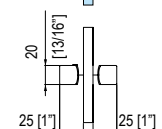
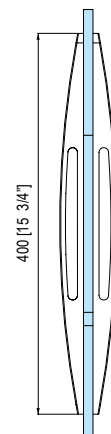
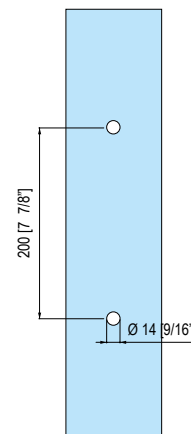
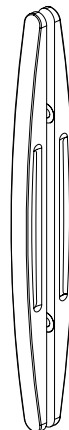

BS35

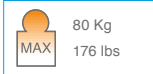

- SOFT-CLOSE meccanismo frenante per chiusure ammortizzate. Applicabile su richiesta ai sistemi serie Slak.
- SOFT-CLOSE mecanismo de freno para el bloqueo de amortización. Aplicable contra demanda a el sistema series Slak.
- SOFT-CLOSE breaking mechanism for amortized locking. Applicable on demand to Slak system series.
- SOFT-CLOSE Bremsmechanismus für gedämpfte Schließung und ist bei Bedarf an Slak systems.
- Système d'amortisseur SOFT-CLOSE pour fermeture amortie. Applicable sur demande aux systèmes Slak.

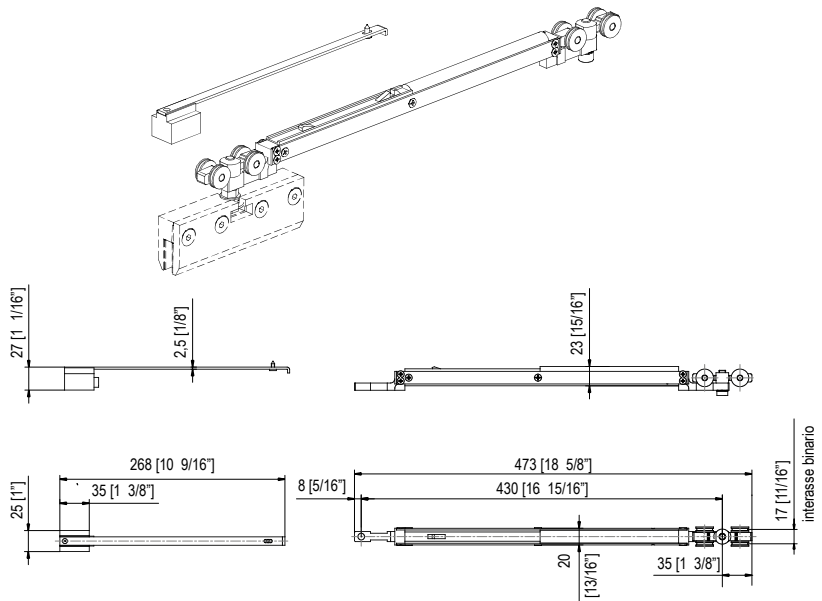

SCHEMI E INGOMBRI MINIMI DELLE APPLICAZIONI - DIBUJOS Y DIMENSIONES MÍNIMAS DE APLICACIONES - DRAWINGS AND OVERALL SIZES OF APPLICATIONS - ZEICHNUNGEN UND AUßENMASSEN DER ANWENDUNGEN - DESSINS DISPONIBLES POUR TOUTES LES TAILLES

Porta singola con soft-close in chiusura - Sola puerta con cierre suave "soft-close" en cierre - Single door with soft-close at closing - Einzeltür mit Soft-Close beim Schließen - Porte simple avec soft-close à la fermeture

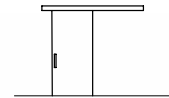
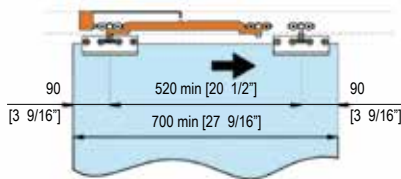

Porta singola con soft-close in chiusura e apertura - Sola puerta con cierre suave "soft-close" en cierre y apertura - Single door with softclose at closing and opening - Einzeltür mit Soft-Close beim Schließen und Öffnen - Porte simple avec soft-close à la fermeture et ouverture

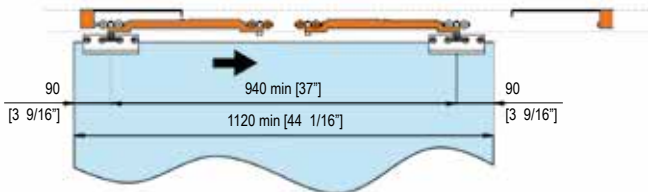

Porta doppia con soft-close in chiusura - Doble puerta con cierre suave "soft-close" en cierre - Double door with soft-close at closing - Doppeltür mit Soft-Close beim Schließen - Porte double avec soft-close à la fermeture

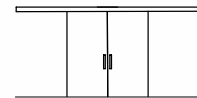
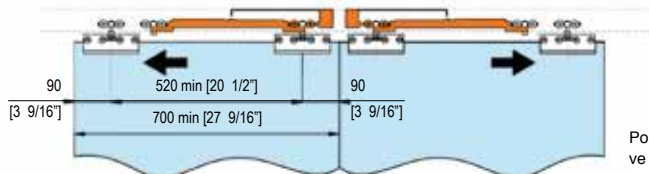

Porta doppia con soft-close in chiusura e apertura - Doble puerta con cierre suave "soft-close" en cierre y apertura - Double door with soft-close at closing and opening - Doppeltür mit Soft-Close beim Schließen und Öffnen - Porte double avec soft-close à la fermeture et l'ouverture

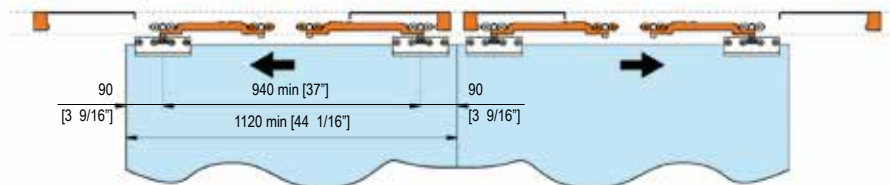





PORTE ESTERNE

Puertas Exteriores
Outer Doors
Aussentüren
Portes Extérieures

cerniere oleodinamiche / oildynamic hinges

Biloba EVO



835E10N



835E50



Alluminio / Aluminium - finiture / colors 02-05-13-14-15-16-17-22

Prodigiosa e rivoluzionaria: è la cerniera con chiudiporta integrato per porte in battuta interne ed esterne. La prima cerniera con chiusura regolabile e controllo costante di frenatura, per tutte le angolazioni di apertura della porta fino a 180°. Disponibile anche nella versione con automatismo di chiusura da 90° a 0°. Controllo costante di frenatura. Cerniera libera da 90° a 180°. Fornita di un ammortizzatore anti-scardinamento e dotata di un dispositivo di sovrappressione che evita rotture in caso di stratonamento accidentale. Si installa a muro o legno e su stipiti con profilo in battuta.

Prodigiosa y revolucionaria: la bisagra con cierra puerta "integrado" para puerta interior y exterior – con tope. La primera bisagra con cierre ajustable y control constante de frenado, para todos los ángulos de apertura de la puerta hasta 180°. Disponible también con cierre automático, desde 90° a 0°. Control constante de frenado. Bisagra "libre" desde 90° a 180°. Provista de un amortiguador anti-desquiciamiento y equipada con un dispositivo de superpresión que evita la rotura en caso de empujones accidentales. Se instala a pared, a madera o con puertas con perfil y tope. Profundidad estípote entre 30 y 50 mm.

Prodigious and revolutionary: hinge with integrated door closer for doors with stop both internal and external. The first hinge with adjustable closing and constant braking control, for all door opening angles up to 180°. Also available in the version with automatic closing from 90° to 0°. Free hinge from 90° to 180°. It prevents unhinging through a shock

absorber and has an over-pressure device that avoids breaking in accidental shoving scenarios. May be fixed to wall, wood or profiles with a stop. Jamb depth from 30 to 50 mm.

Erstaunlich und revolutionär: das Band mit integriertem Türschließer für Anschlagtüren im Innen- und Außenbereich. Das erste Hydraulikband mit einer regulierbaren Schließgeschwindigkeit und konstanter Kontrolle der Bremsung, für alle Öffnungswinkel der Tür bis 180°. Ebenfalls in der Automatik Version verfügbar von 90° bis 0°. Mit konstanter Bremskontrolle. Freilauf des Bandes vom 90° bis 180°. Das Band ist mit einer Dämpfung ausgestattet, die eine Aushebelung der Tür verhindert, sowie einen etwaigen Überdruck reguliert und somit Bruch durch eventuelle plötzliche Stöße kompensiert. Man kann es an der Wand, Holz oder auf Türen mit Rahmen installieren. Tiefe des Türpfosten von 30 bis 50 mm.

Prodigieuse et révolutionnaire : c'est la charnière avec système de fermeture intégré pour portes à butée intérieure et extérieure. La première charnière avec réglage et contrôle de la vitesse de fermeture, pour tout type d'angle jusqu'à 180°. Disponible également en version fermeture automatique de 90° à 0°, avec contrôle constant de la fermeture. Charnière libre de 90° à 180°. Munie d'un amortisseur anti-dégondage et équipée d'un dispositif de suppression qui permet d'éviter la rupture en cas de choc accidentel. Peut être installé au mur, sur bois ou profils avec stop. Profondeur de jambage de 30 à 50 mm.



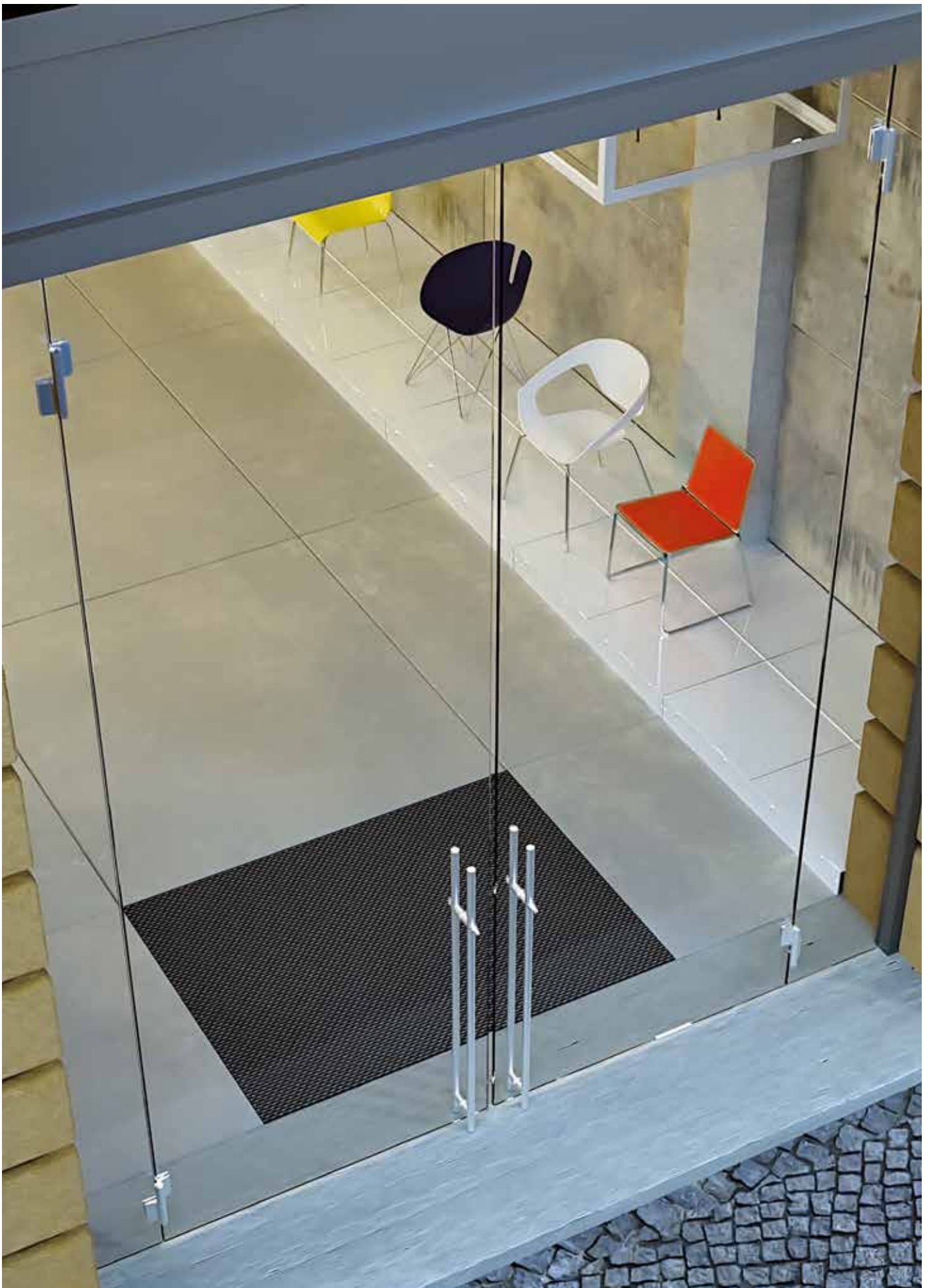

835E10N

Biloba Evo oildynamic hinge

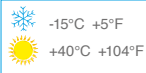
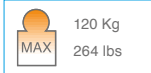
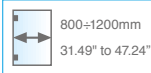
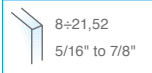

• Cerniera oleodinamica vetro-muro per porte in battuta, con velocità di chiusura regolabile e controllo costante di frenatura; permette un'apertura della porta fino a 180°. Stop a +90° +180°. **Si installa su porte con profilo in battuta. Profondità stipite da 30 a 50 mm.**

• Bisagra automática hidráulica vidrio-pared para puerta con tope; regulación de velocidad de cierre de la puerta y control constante de frenado; la puerta se puede abrir hasta 180°. Stop a +90° +180°. **Se instala en puertas con perfil con batida. Profundidad estipite entre 30 y 50 mm.**

• Hydraulic hinge glass to wall for doors with stop, with adjustable closing speed and constant braking control; the door opens up to 180°. Stop at +90° +180°. **Installed on doors with a profile on a stop. Jamb depth from 30 to 50 mm.**

• Hydraulikband Glas-Wand für Anschlagtüren, mit regulierbar Schließgeschwindigkeit und konstanter Kontrolle der Bremsung; Öffnung der Tür bis 180°. Feststellung +90° +180°. **Man kann es auf Türen mit Rahmen benutzen. Pfostentiefe von 30 bis 50 mm.**

• Charnière hydraulique verre-mur pour porte à butée avec contrôle constant de la vitesse de fermeture : permet une ouverture de la porte jusqu'à 180°. Arrêt à +90° et +180°. **S'installe sur profil de porte. Profondeur de jambage de 30 à 50 mm.**

835E10N R = destra - derecha - right - rechts - droite
835E10N L = sinistra - izquierda - left - links - gauche

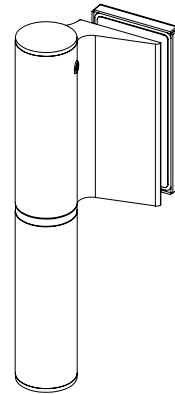

835E10NL



• È necessaria una battuta in chiusura in quanto la cerniera ha una precarica. • Necesita de un cierre con tope, puesto que la bisagra tiene una precarga. • The hinge has a loading and it is therefore necessary a closing stop. • Eine Schließfeststellung ist notwendig, weil das Scharnier eine mechanische Belastung hat. • La charnière a une charge, il est donc nécessaire d'avoir un arrêt de fermeture.

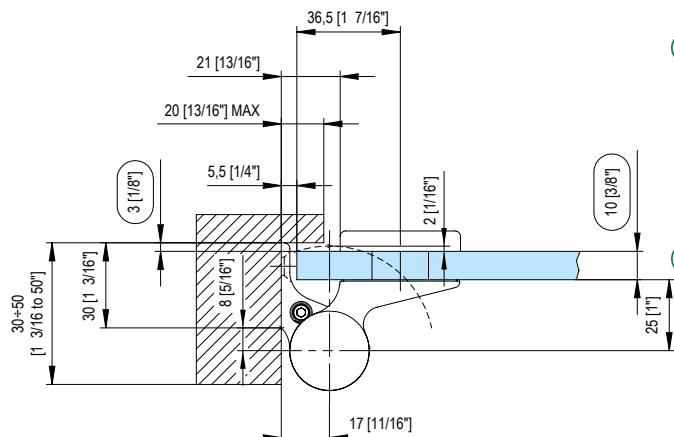
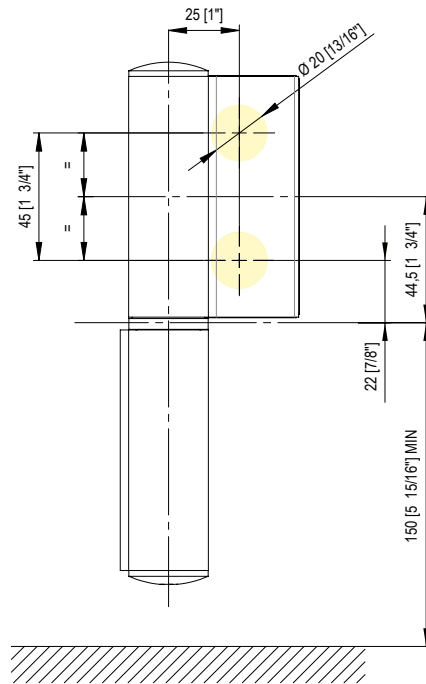
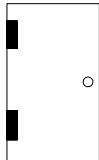

Classificazione secondo normativa - Clasificación según la ley - Classification according to int'l regulation - Klassifizierung nach den Vorschriften - Classification selon la norme

art. 835E10N	UNI EN 1154 : 2006	3	8	3/6	0	1	5
--------------	--------------------	---	---	-----	---	---	---

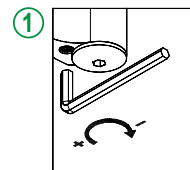
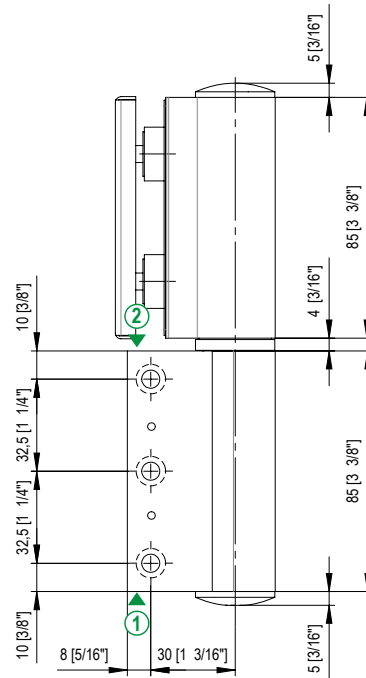

Regolazione scatto finale
Ajuste del resorte final
Final latch adjustment
Regulierung der Endschwung
Réglage de verrouillage final

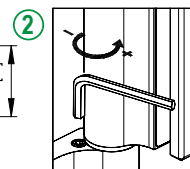

Regolazione della velocità di chiusura
Ajuste de la velocidad de cierre
Closing speed adjustment
Regulierung der Schließgeschwindigkeit
Réglage de la vitesse de fermeture

835E11N

Biloba Evo oleodynamic hinge

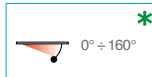

• Cerniera oleodinamica vetro-muro per porte in battuta, con velocità di chiusura regolabile e controllo costante di frenatura; permette un'apertura della porta fino a 180°. Stop a +180°. **Si installa su porte con profilo in battuta. Profondità stipite da 30 a 50 mm.**

• Bisagra automática hidráulica vidrio-pared para puerta con tope; regulación de velocidad de cierre de la puerta y control constante de frenado; la puerta se puede abrir hasta 180°. Stop a +180°. **Se instala en puertas con perfil con batida. Profundidad estipite entre 30 y 50 mm.**

• Hydraulic hinge glass to wall for doors with stop, with adjustable closing speed and constant braking control; the door opens up to 180°. Stop at +180°. **Installed on doors with a profile on a stop. Jamb depth from 30 to 50 mm.**

• Hydraulikband Glas-Wand für Anschlagtüren, mit regulierbar Schließgeschwindigkeit und konstanter Kontrolle der Bremsung; Öffnung der Tür bis 180°. Feststellung +180°. **Man kann es auf Türen mit Rahmen benutzen. Pfostentiefe von 30 bis 50 mm.**

• Charnière hydraulique verre-mur pour porte à butée, avec contrôle de la vitesse de fermeture. Elle autorise une ouverture de la porte jusqu'à 180°. Arrêt à 180°. **S'installe sur porte à butée avec profil. Profondeur de jambage de 30 à 50 mm.**

835E11N R = destra - derecha - right - rechts - droite
835E11N L = sinistra - izquierda - left - links - gauche

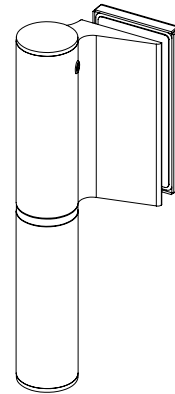

835E11NL

* È necessaria una battuta in chiusura in quanto la cerniera ha una pre-carica. • Necesita de un cierre con tope, puesto que la bisagra tiene una pre-carga. • The hinge has a loading and it is therefore necessary a closing stop. • Eine Schließfeststellung ist notwendig, weil das Scharnier eine mechanische Belastung hat. • La charnière a une charge, il est donc nécessaire d'avoir un arrêt de fermeture.

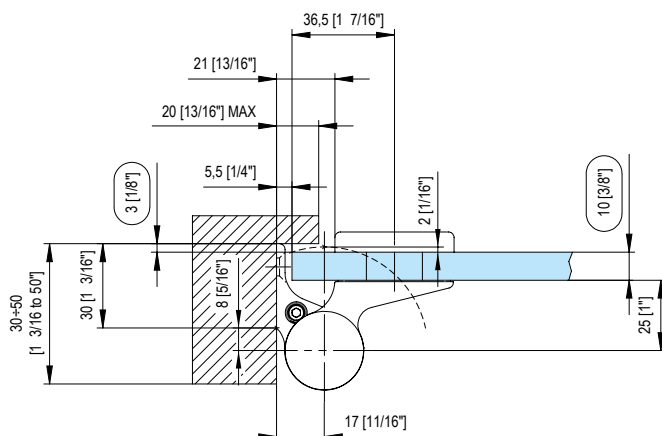
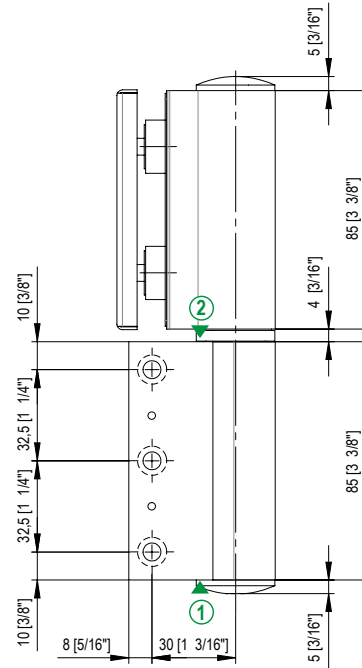
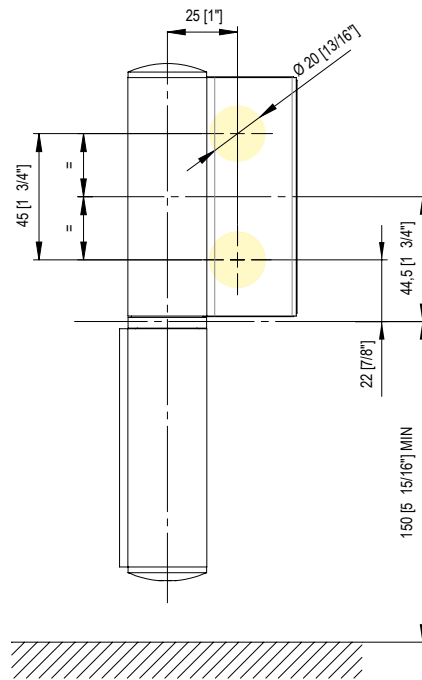
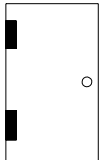

Classificazione secondo normativa - Clasificación según la ley - Classification according to int'l regulation - Klassifizierung nach den Vorschriften - Classification selon la norme

art. 835E11N	UNI EN 1154 : 2006	3	8	3/6	0	1	5
--------------	--------------------	---	---	-----	---	---	---

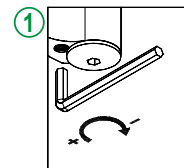

Regolazione scatto finale
Ajuste del resorte final
Final latch adjustment
Regulierung der Endschwung
Réglage de verrouillage final

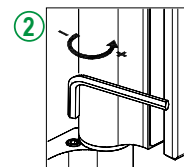

Regolazione della velocità di chiusura
Ajuste de la velocidad de cierre
Closing speed adjustment
Regulierung der Schließgeschwindigkeit
Réglage de la vitesse de fermeture

835E50

Biloba Evo oildynamic hinge

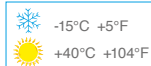
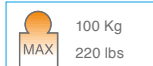
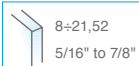

• Cerniera oleodinamica vetro-vetro per porte in battuta, con velocità di chiusura regolabile e controllo costante di frenatura; permette un'apertura della porta fino a 180°. Stop a +90° +180°. **Si installa su porte con profilo in battuta. Profondità stipite da 30 a 50 mm.**

• Bisagra automática hidráulica vidrio-vidrio para puerta con tope; regulación de velocidad de cierre de la puerta y control constante de frenado; la puerta se puede abrir hasta 180°. Stop a +90°, +180°. **Se instala en puertas con perfil con batida. Profundidad estipite entre 30 y 50 mm.**

• Hydraulic hinge glass to glass for doors with stop, with adjustable closing speed and constant braking control; the door opens up to 180°. Stop at +90° +180°. **Installed on doors with a profile on a stop. Jamb depth from 30 to 50 mm.**

• Hydraulikband Glas-Glas für Anschlagtüren, mit regulierbar Schließgeschwindigkeit und konstanter Kontrolle der Bremsung; Öffnung der Tür bis 180°. Feststellung +90° +180°. **Man kann es auf Türen mit Rahmen benutzen. Pfostentiefe von 30 bis 50 mm.**

• Charnière hydraulique verre-mur pour porte en butée, avec vitesse de fermeture réglable et contrôle constant du freinage; permet une ouverture de la porte à 180°. Arrêt à +90° et +180°. **S'installe sur profil de porte. Profondeur de jambage de 30 à 50 mm.**

835E50 R = destra - derecha - right - rechts - droite
835E50 L = sinistra - izquierda - left - links - gauche

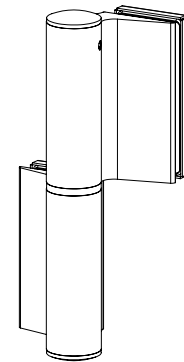

835E50L

*

• È necessaria una battuta in chiusura in quanto la cerniera ha una pre-carica. • Necesita de un cierre con tope, puesto que la bisagra tiene una precarga. • The hinge has a loading and it is therefore necessary a closing stop. • Eine Schließfeststellung ist notwendig, weil das Scharnier eine mechanische Belastung hat. • La charnière a une charge, il est donc nécessaire d'avoir un arrêt de fermeture.

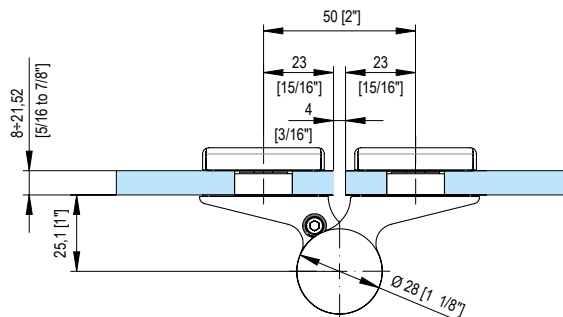
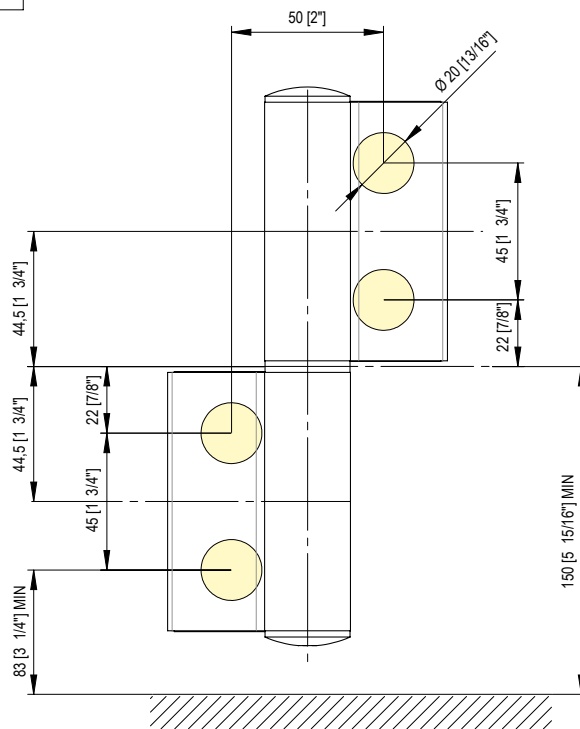
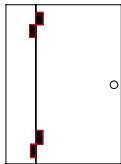

Classificazione secondo normativa - Clasificación según la ley - Classification according to int'l regulation - Klassifizierung nach den Vorschriften - Classification selon la norme



art. 835E50 UNI EN 1154 : 2006 3 8 3/6 0 1 5

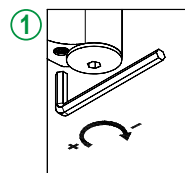
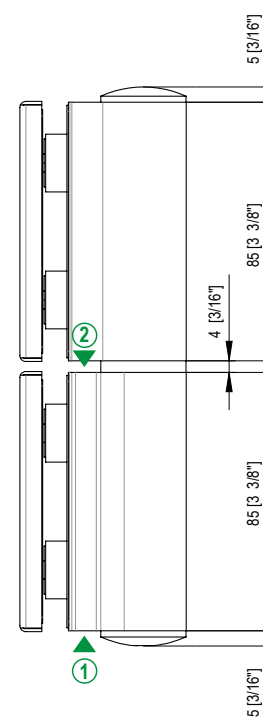

Regolazione scatto finale
 Ajuste del resorte final
 Final latch adjustment
 Regulierung der Endschwingung
 Réglage de verrouillage final

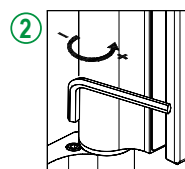

Regolazione della velocità di chiusura
 Ajuste de la velocidad de cierre
 Closing speed adjustment
 Regulierung der Schließgeschwindigkeit
 Réglage de la vitesse de fermeture

835E51

Biloba Evo oildynamic hinge

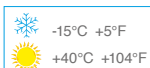
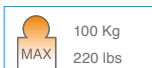
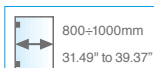
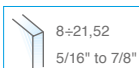

• Cerniera oleodinamica vetro-vetro per porte in battuta, con velocità di chiusura regolabile e controllo costante di frenatura; permette un'apertura della porta fino a 180°. Stop a +180°. **Si installa su porte con profilo in battuta. Profondità stipite da 30 a 50 mm.**

• Bisagra automática hidráulica vidrio-vidrio para puerta con tope; regulación de velocidad de cierre de la puerta y control constante de frenado; la puerta se puede abrir hasta 180°. Stop a +180°. **Se instala en puertas con perfil con batida. Profundidad estípite entre 30 y 50 mm.**

• Hydraulic hinge glass to glass for doors with stop, with adjustable closing speed and constant braking control; the door opens up to 180°. Stop at +180°. **Installed on doors with a profile on a stop. Jamb depth from 30 to 50 mm.**

• Hydraulikband Glas-Glas für Anschlagtüren, mit regulierbar Schließgeschwindigkeit und konstanter Kontrolle der Bremsung; Öffnung der Tür bis 180°. Feststellung +180°. **Man kann es auf Türen mit Rahmen benutzen. Pfostentiefe von 30 bis 50 mm.**

• Charnière hydraulique verre-mur pour porte en butée, avec vitesse de fermeture réglable et contrôle constant de freinage; permet une ouverture de la porte à 180°. Arrêt à +180°. **S'installe sur profil de porte. Profondeur du jambage de 30 à 50 mm.**

835E51 R = destra - derecha - right - rechts - droite
835E51 L = sinistra - izquierda - left - links - gauche

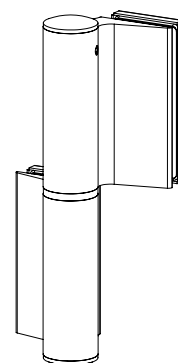

835E51L

*

• È necessaria una battuta in chiusura in quanto la cerniera ha una pre-carica. • Necesita de un cierre con tope, puesto que la bisagra tiene una precarga. • The hinge has a loading and it is therefore necessary a closing stop. • Eine Schließfeststellung ist notwendig, weil das Scharnier eine mechanische Belastung hat. • La charnière a une charge, il est donc nécessaire d'avoir un arrêt de fermeture.

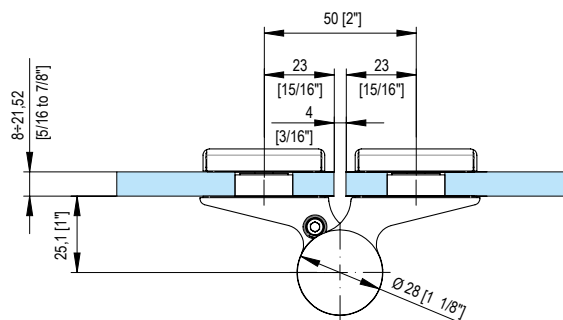
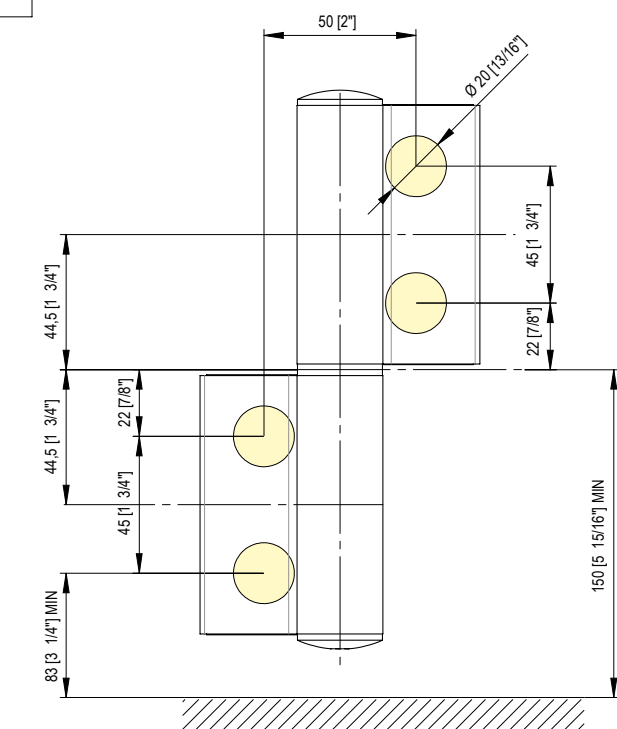
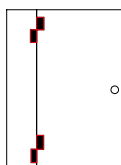

Classificazione secondo normativa - Clasificación según la ley - Classification according to int'l regulation - Klassifizierung nach den Vorschriften - Classification selon la norme



art. 835E51 UNI EN 1154 : 2006 3 8 3/6 0 1 5

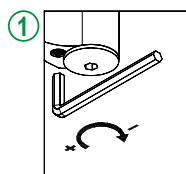
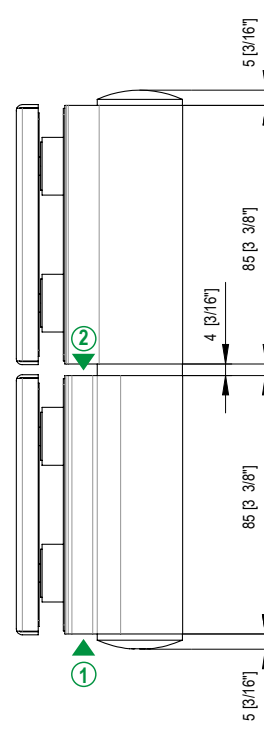

Regolazione scatto finale
Ajuste del resorte final
Final latch adjustment
Regulierung der Endschwung
Réglage de verrouillage final

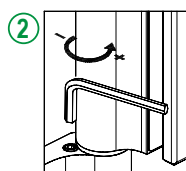

Regolazione della velocità di chiusura
Ajuste de la velocidad de cierre
Closing speed adjustment
Regulierung der Schließgeschwindigkeit
Réglage de la vitesse de fermeture

cerniere oleodinamiche / oildynamic hinges

Biloba Evo VELA



845E10



845E20



Alluminio / Aluminium - finiture / colors 02

Cerniera oleodinamica a scomparsa, per porte con profili in battuta. La prima cerniera di Colcom completamente "nascosta" nel profilo e adattabile ad ogni progetto su richiesta del cliente. Mantiene le consuete e garantite caratteristiche delle cerniere chiudiporta della serie Biloba Evo. Chiusura Oleodinamica. Invisibile perché nascosta nel profilo. Personalizzabile per soddisfare ogni progetto specifico del cliente. Regolazione della velocità di chiusura. Stop a 90°. Misure minime di ingombro 25x25 mm. La cerniera superiore si accompagna ed è abbinata a quella inferiore dedicata.

Bisagra hidráulica escondida, para puertas con marco y tope. La primera bisagra de Colcom completamente escondida dentro el perfil, y adaptable a cualquier proyecto, a petición. Mantiene las mismas características de las bisagras Biloba Evo. Cierrapuerta hidráulico. Invisible – escondida dentro del perfil. Personalizable para satisfacer cualquier proyecto específico. Velocidad de cierre regulable. Fermo a 90°. Dimensiones mínimas 25x25 mm. La aplicación de la bisagra superior se completa con la bisagra inferior dedicada.

Hidden oildynamic doorcloser hinge, for framed doors with a stop. The first Colcom hinge which is completely hidden into the profile, and adaptable to every project upon customer request. It maintains the same features as the Biloba Evo series hinges. Hydraulic Closing. Invisible – hidden into the profile. Customizable, in order to satisfy every specific

project. Adjustability of the closing speed. 90° Stop. Minimum dimensions 25x25 mm. The installation of the upper hinge is completed by the dedicated hidden lower hinge.

Integrierte Hydrauliktürband-, für Anschlagtüren mit Rahmenprofil. Das erste-s Band von Colcom, das komplett im Rahmen integriert ist. Auf Anfrage kann dieses Band Kunden- und Projektspezifisch gefertigt werden. Das Band verfügt über die Merkmale der Biloba Evo Bänder. Hydraulischer Türschließer. Unsichtbar – integriert im Rahmen. Anpassbar, um alle Projektansprüche zu erfüllen. Schließgeschwindigkeit ist einstellbar. 90° Feststellung. Mindestdimension 25x25 mm. Das obere Band und das untere Band bilden das komplette System.

Charnière hydraulique rétractable pour portes avec profil d'arrêt. La première charnière Colcom à « disparaître » complètement dans le profil, adaptable à tous les projets et aux demandes spécifiques du client. Garde les caractéristiques éprouvées et garanties des charnières ferme-porte de la série Biloba Evo. Ferme-porte hydraulique. Cachée dans le profil, la charnière est invisible. Personnalisable, elle s'adapte au projet spécifique du client. Réglage de la vitesse de fermeture. Arrêt à 90°. Dimensions minimales d'encombrement 25x25 mm. La charnière supérieure est accompagnée de la charnière inférieure adaptée.





845E10

Biloba Evo VELA oildynamic hinge

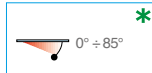
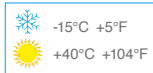
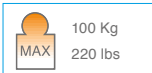

- Cerniera oleodinamica a terra a scomparsa. Per porte con frame in battuta. Velocità di chiusura regolabile e controllo costante di frenatura; permette un'apertura porta fino a 180°. Stop a +90°, anche a 180° secondo progetto parete.
- Bisagra hidráulica oculta de suelo. Para puertas batientes con marco. Velocidad de cierre ajustable y control de frenado constante; permite apertura de puerta hacia 180°. Stop a +90°, también a 180° dependiendo del proyecto de pared.
- Hidden bottom hydraulic hinge. For framed doors with a stop. Adjustable closing speed and constant braking control; the door opens up to 180°. Stop at +90°, and at +180° according to wall project.
- Einklappbares Bodenhydraulikband. Für Anschlagtüren mit Rahmen. Regulierbar Schließgeschwindigkeit und konstanter Kontrolle der Bremsung. Öffnung der Tür bis 180°. Feststellung +90° und +180° (nach Wandprojekt).
- Charnière hydraulique inférieure rétractable. Pour portes avec encadrement à butée. Avec contrôle constant de la vitesse de fermeture; elle permet une ouverture de la porte jusqu'à 180°. Arrêt à +90°, et à +180° selon le projet de paroi.

845E10 R = destra - derecha - right - rechts - droite
845E10 L = sinistra - izquierda - left - links - gauche

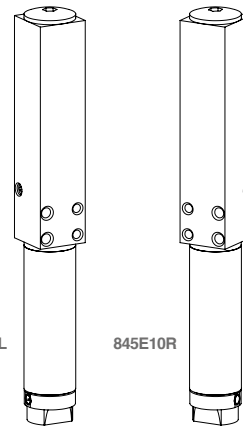

* • È necessaria una battuta in chiusura in quanto la cerniera ha una precarica. • Necesita de un cierre con tope, puesto que la bisagra tiene una precarga. • The hinge has a loading and it is therefore necessary a closing stop. • Eine Schließfeststellung ist notwendig, weil das Scharnier eine mechanische Belastung hat. • La charnière a une charge, il est donc nécessaire d'avoir un arrêt de fermeture.

Per un ottimale sviluppo del progetto applicazione personalizzato è possibile rivolgersi al nostro ufficio tecnico - Para un óptimo desarrollo del proyecto de aplicación personalizada puede contactar nuestro departamento técnico - In order to have an optimal development of the application, you can consult our technical department - Für eine optimale Entwicklung des Projekts, dürfen Sie sich mit unserem Technischem Büro umdrehen - Pour un développement optimal du projet d'application personnalisée vous pouvez contacter notre service technique.

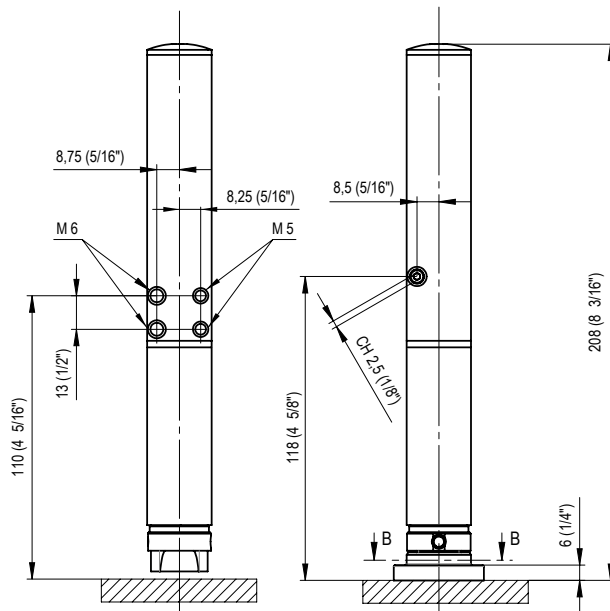

ADATTATORE PER FORO PROFILO
NON INCLUSO
ADJUSTABILITY DEVICE NOT INCLUDED

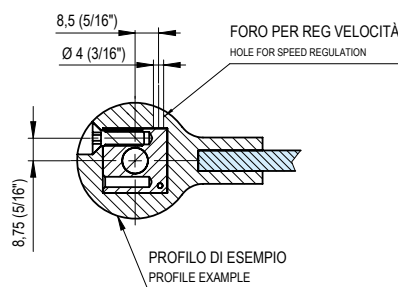
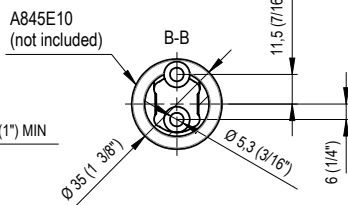
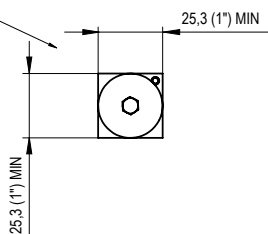

NON COMPRESO
NOT INCLUDED

A845E10



NON COMPRESO
NOT INCLUDED



VITI non comprese
not included SCREWS

PROFILO DI ESEMPIO
PROFILE EXAMPLE

FORO PER REG VELOCITÀ
HOLE FOR SPEED REGULATION

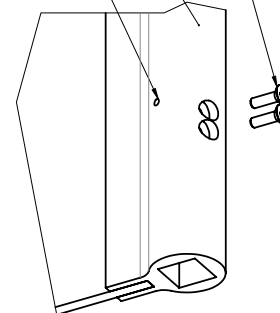

CERNIERA
HINGE

A845E10
BASE non compresa
NOT INCLUDED BASE PLATE

cerniere oleodinamiche / oildynamic hinges

Triloba



8201



8202



8204

8205

8206

8207

8208

8209

Alluminio / Aluminium - finiture / colors 02-05-13-14-15-16-17

Triloba ha la possibilità di regolare le valvole frenanti con funzione anti-vento di sicurezza. È disponibile il set completo per sopralluce e vetri fissi laterali, per spessori vetro 10-12 mm e per porte fino a 150 kg. Prodotto coperto da brevetto internazionale.

Triloba tiene la posibilidad de ajustar las válvulas de frenado con función cortaviento y de seguridad. El set completo está disponible por la luna y por vidrios laterales fijos, de espesor 10-12 mm y para puertas hasta 150 kg. Cubierta por una patente internacional.

Triloba has the possibility to adjust the braking valves with anti-wind and safety function. Availability of a complete set for transom link and

Alluminio / Aluminium - finiture / colors 02-05-14-15-16-17-31

side, fixed glazings, for glass thickness 10-12mm and for doors till 150 Kgs. Product covered by international patent.

Triloba die Bremsventile können mit Windschutz- und Sicherheitsfunktion eingestellt werden. Verfügbarkeit eines kompletten Zubehöresseset für Oberlicht-seitliches Fenster, für Glas-dicke 10-12mm und bis 150 Kgs. International patentgeschützt.

La Triloba offre la possibilità d'ajuster les valves de freinage avec une fonction anti-vent et de sécurité. Kit complet disponible pour imposte et panneaux latéraux fixes, pour épaisseur de verre 10-12 mm et pour portes jusqu'à 150 kg. Produit couvert par un brevet international.





8201

Triloba oildynamic hinge

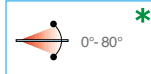

- Cerniera oleodinamica inferiore con regolazione delle velocità di chiusura dell'anta. Stop a 0° +90° -90°.
- Bisagra automática hidráulica inferior con regulación de velocidad de cierre de la puerta. Stop a 0°, + 90°, -90°.
- Bottom hydraulic hinge with adjustment of the closing speed of the door. Stop at 0° +90° -90°.
- Selbstschließendes unteres Hydraulikband mit Regelung der Schließgeschwindigkeit und Feststellung +/-90°.
- Charnière hydraulique avec réglage de la vitesse de fermeture du battant. Arrêt à 0°, +90° et -90°.

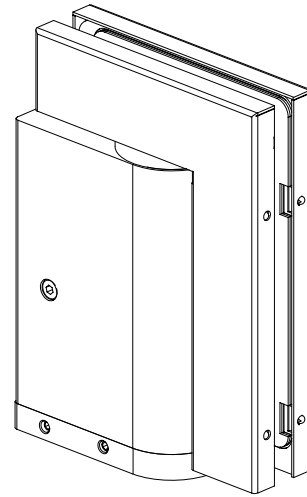

APERTURE VIOLENTE OLTRE I 95° POTREBBERO CAUSARE LO SCARDINAMENTO. È CONSIGLIABILE L'APPLICAZIONE DI UN FERMAPORTA - APERTURA VIOLENTA ADEMÁS DE 95°, PODRÍA CAUSAR DAÑO. ACONSEJAMOS UTILIZAR UN FIJA PUERTA. - VIOLENT OPENING FURTHER THAN 95° COULD UNHINGE THE DOOR. WE SUGGEST TO INSTALL A DOOR STOPPER - HEFTIGE ÖFFNUNGEN MEHR ALS 95° KÖNNTEN DIE TÜR AUSHEBEN. WIR SCHLAGEN DIE VERWENDUNG EINES TÜRHALTERS VOR - UNE BRUSQUE OUVERTURE A PLUS DE 95° POURRAIT ENTRAINER UNE SORTIE DES GONDS. NOUS CONSEILLONS L'INSTALLATION D'UNE BUTÉE

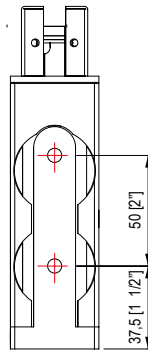
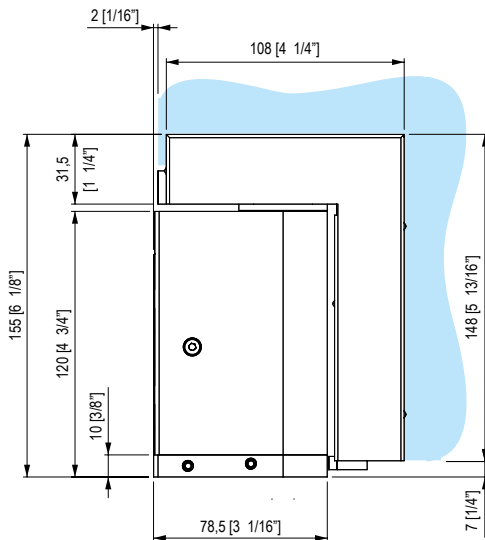
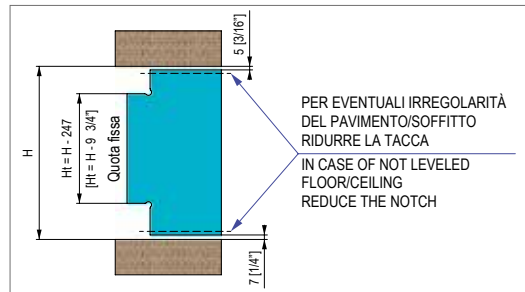
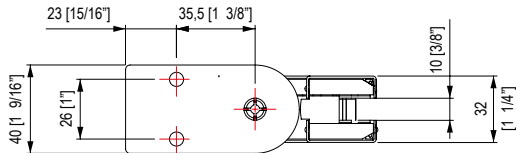

Classificazione secondo normativa - Clasificación según la ley - Classification according to int'l regulation - Klassifizierung nach den Vorschriften - Classification selon la norme

art. 8201	UNI EN 1154 : 2006	3	8	3/6	0	1	4
-----------	--------------------	---	---	-----	---	---	---

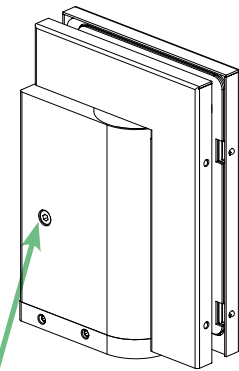
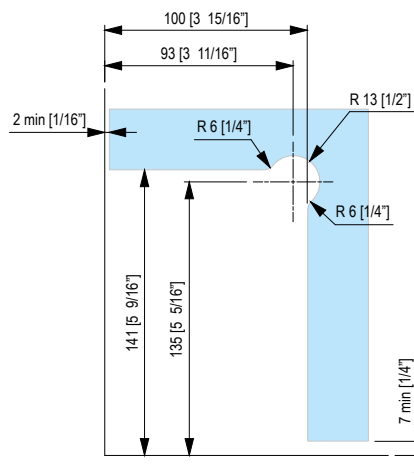

Ugello di regolazione della velocità di chiusura della porta.
Válvula de ajuste de la velocidad de cierre de la puerta.
Control valve for the closing speed of the door.
Regelventil für die Türschließgeschwindigkeit.
Valve de réglage de l'intensité de freinage.

8202

Triloba oleodynamic hinge



- Dissipatore oleodinamico superiore con regolazione dell'intensità frenante.
- Bisagra automática hidráulica superior con dispositivo de frenado.
- Top hydraulic hinge with control valve for brake.
- Oberer Hydraulikdämpfer mit Regelung der Bremsstärke.
- Charnière hydraulique supérieure avec réglage de l'intensité de freinage.

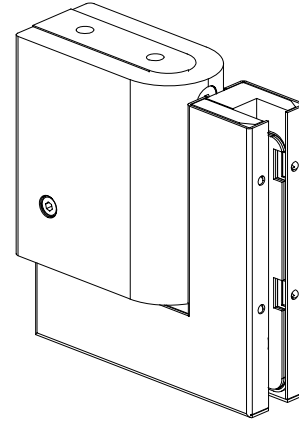

APERTURE VIOLENTE OLTRE I 95° POTREBBERO CAUSARE LO SCARDINAMENTO. È CONSIGLIABILE L'APPLICAZIONE DI UN FERMAPORTA - APERTURA VIOLENTE ADEMÁS DE 95°, PODRÍA CAUSAR DAÑO. ACONSEJAMOS UTILIZAR UN FIJA PUERTA. - VIOLENT OPENING FURTHER THAN 95° COULD UNHINGE THE DOOR. WE SUGGEST TO INSTALL A DOOR STOPPER - HEFTIGE ÖFFNUNGEN MEHR ALS 95° KÖNNTEN DIE TÜR AUSHEBEN. WIR SCHLAGEN DIE VERWENDUNG EINES TÜRHALTERS VOR - UNE BRUSQUE OUVERTURE A PLUS DE 95° POURRAIT ENTRAINER UNE SORTIE DES GONDS. NOUS CONSEILLONS L'INSTALLATION D'UNE BUTÉE

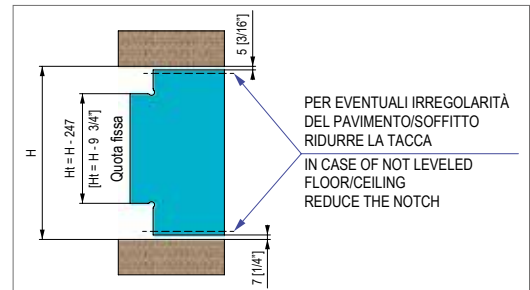
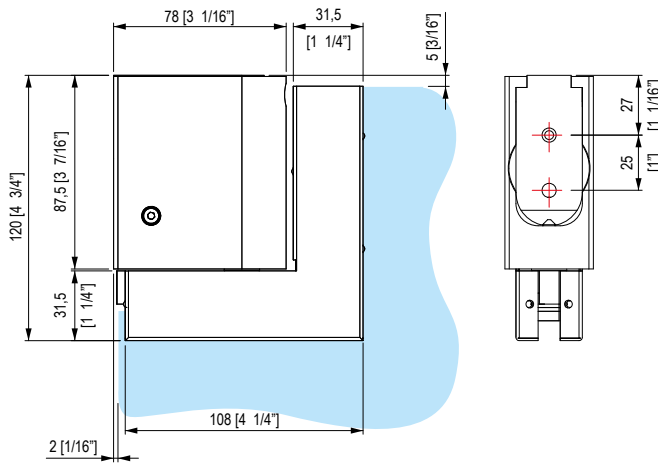

Classificazione secondo normativa - Clasificación según la ley - Classification according to int'l regulation - Klassifizierung nach den Vorschriften - Classification selon la norme

art. 8202	UNI EN 1154 : 2006	3	8	$\frac{3}{8}$	0	1	4
-----------	--------------------	---	---	---------------	---	---	---

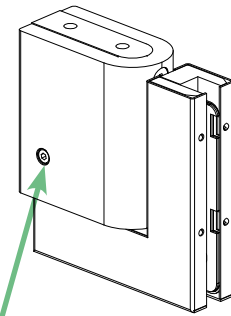
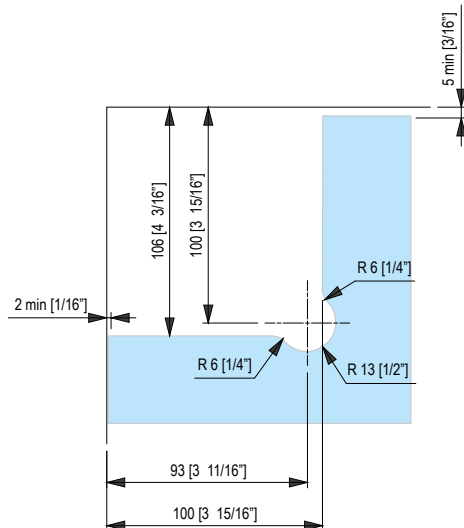
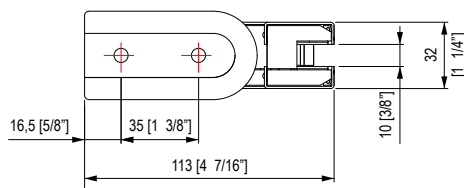

Ugello di regolazione dell'intensità frenante.
Tobera de ajuste de la velocidad de cierre de la puerta.
Control valve for braking intensity.
Regelventil der Bremsstärke.
Valve de réglage de l'intensité de freinage.

8204



- Attacco sopra luce a muro laterale senza battuta.
- Fijación a bisagra superior y montante sin tope.
- Transom attachment -side wall without stop .
- Kupplung für Oberlichtfenster. Montage an der Seitenwand. Ohne Anschlag.
- Fixation latérale mur-imposte sans butée.

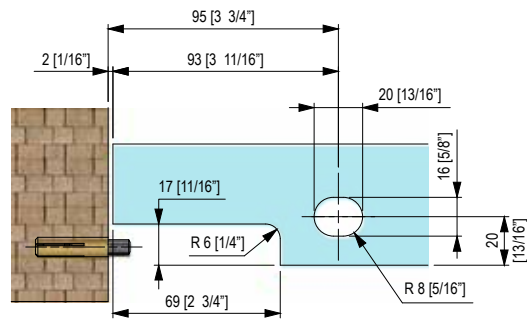
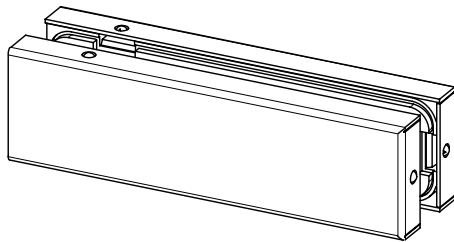
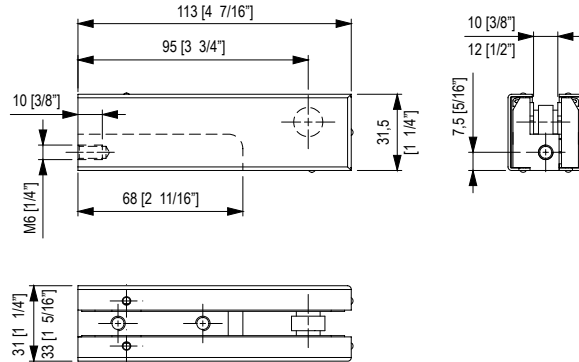
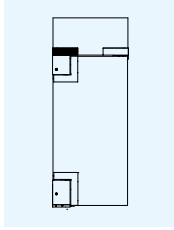

8207



- Attacco sopra luce a muro laterale con battuta.
- Fijación a bisagra superior y montante con tope.
- Transom attachment -side wall with stop.
- Kupplung für Oberlichtfenster. Montage an der Seitenwand. Mit Anschlag.
- Fixation latérale avec butée.

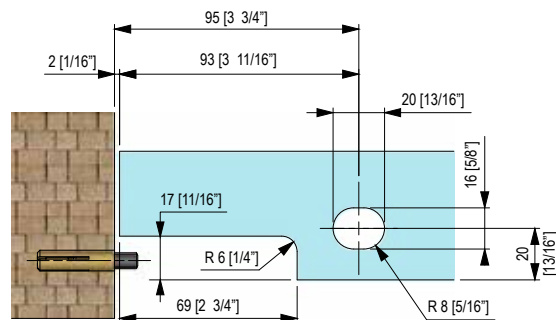
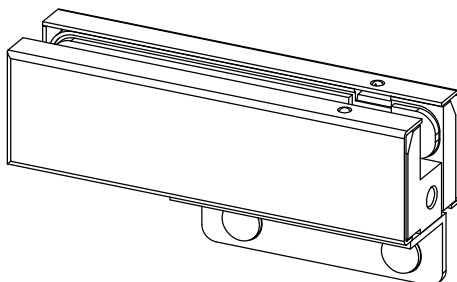
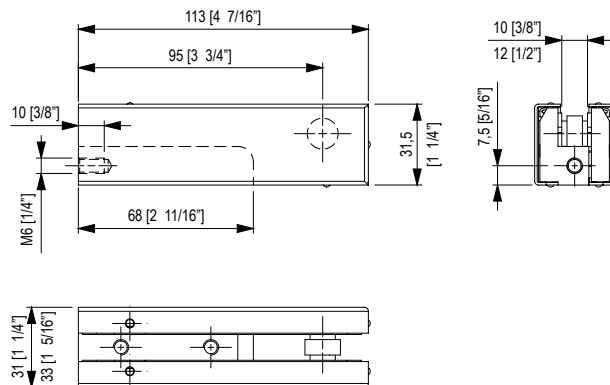
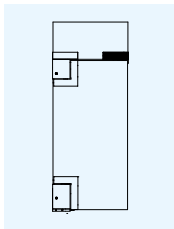

8208



- Attacco cerniera inferiore vetro laterale.
- Fijación a vidrio lateral para bisagra inferior.
- Bottom hinge attachment -side glass.
- Kupplung für unteres Scharnier und Seitenteil.
- Fixation latérale verre-verre charnière inférieure.

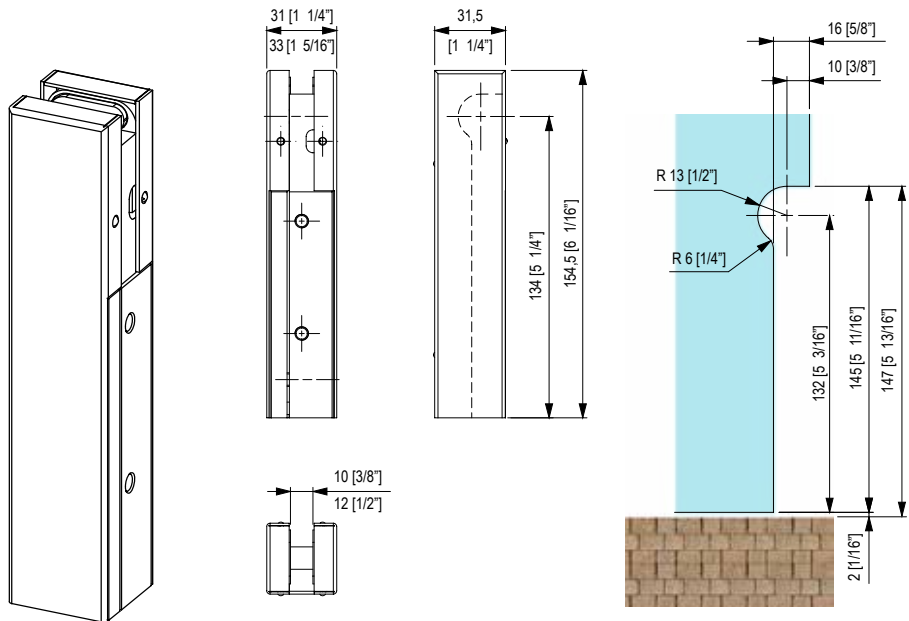
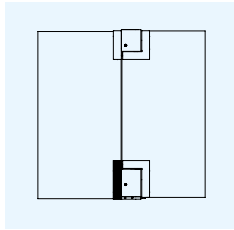

8209

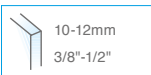

- Attacco cerniera superiore vetro laterale.
- Fijación a vidrio lateral para bisagra superior.
- Upper hinge attachment -side glass .
- Kupplung für oberes Scharnier und Seitenteil.
- Charnière supérieure verre-verre – fixation latérale.

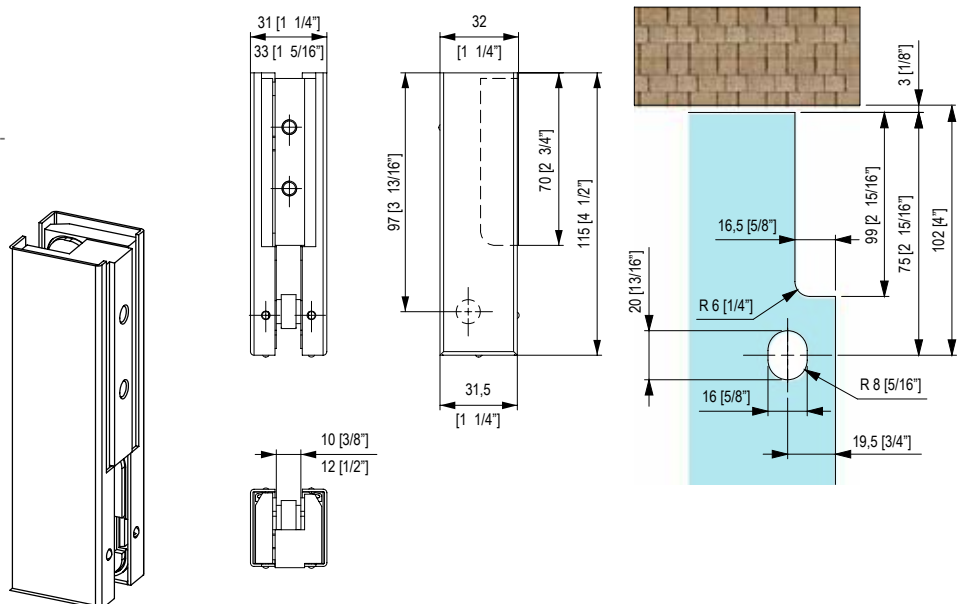
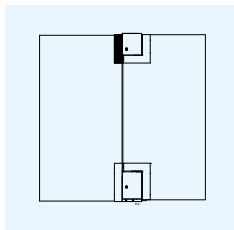

8205

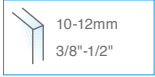

- Attacco sopra luce a vetro laterale senza battuta.
- Fijación a montante y a vidrio lateral para bisagra superior.
- Transom attachment-side glass without stop.
- Kupplung für Oberlichtfenster. Montage am Seitenteil. Ohne Anschlag.
- Fixation imposte-verre latéral sans butée.

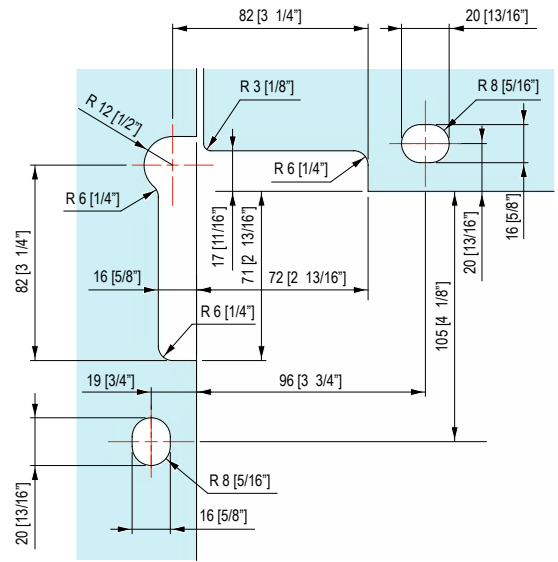
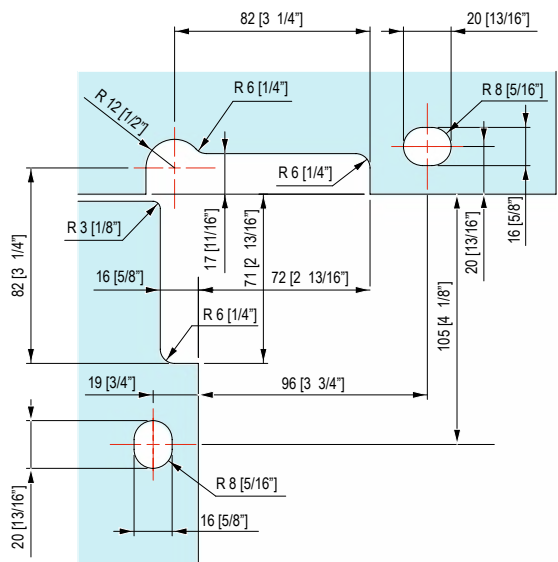
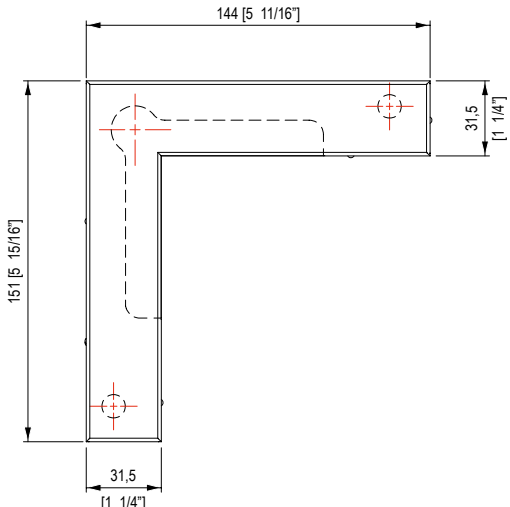
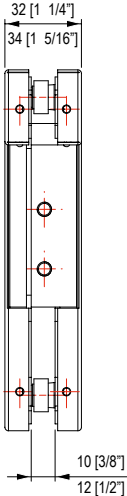
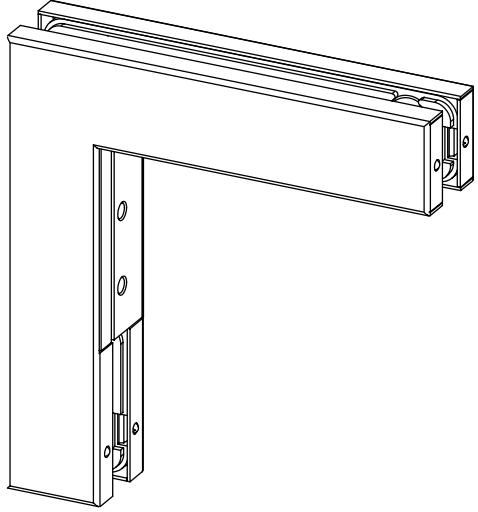
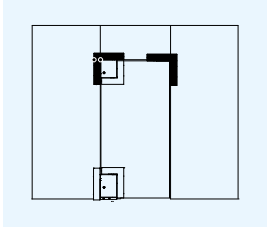

8206

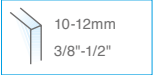

- Attacco sopra luce vetro laterale con battuta.
- Fijacion a montante y a vidrio lateral con tope.
- Transom attachment -side glass with stop.
- Kupplung für Oberlichtfenster. Montage am Seitenteil. Mit Anschlag.
- Fixation imposte-verre latéral avec butée.

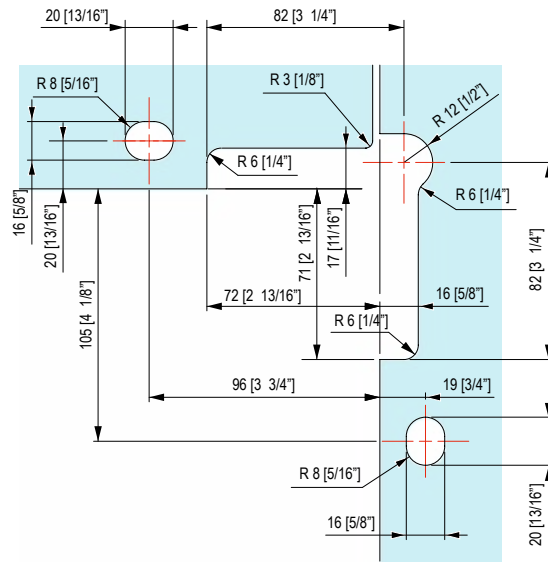
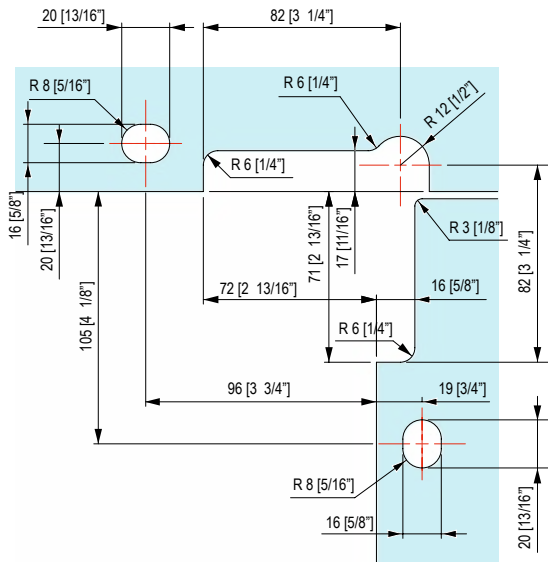
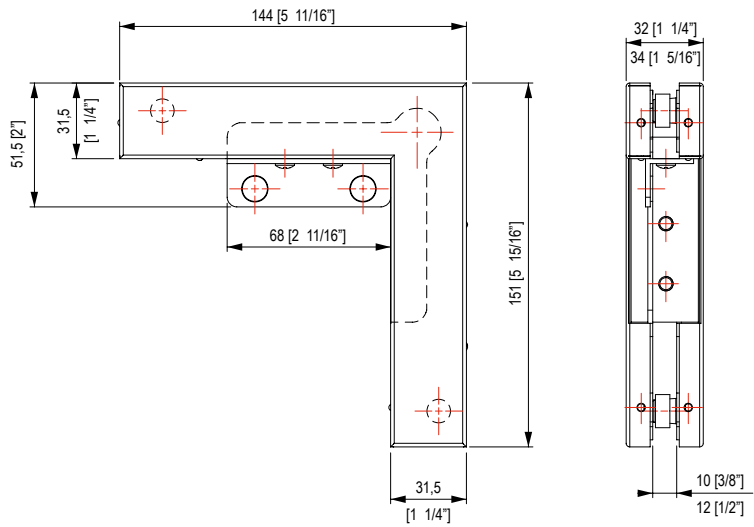
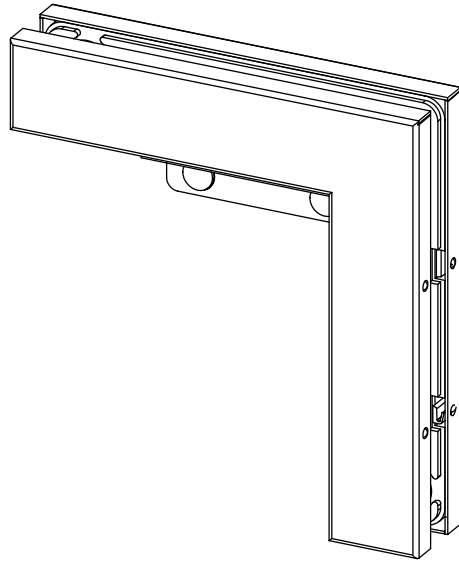
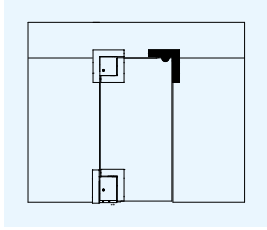

8201



8202



Fissare le staffe angolari (pavimento/muro art.8201; soffitto/muro art.8202) e successivamente infilarvi i corpi. Lasciare allentati i grani della cerniera inferiore (1, 2a, 2b e 3a e 3b). Serrare il grano 5 e poi il grano 4 del dissipatore. Pinzare il vetro mediante le apposite piastre e viti. Effettuare l'allineamento della porta sui grani 2a e 2b sino a serrarli completamente. A regolazione completata bloccare serrando i grani 3a e 3b. Aprire la porta a 90° e serrare quindi il grano 1. Richiudere la porta. Regolare le velocità di chiusura e di dissipazione mediante gli appositi ugelli (vedi pagina sul retro). Applicare i carters di copertura a pressione.

Fijar el ángulo de ensamblaje (suelo/pared artículo 8201 techo/pared artículo 8202); después montar los cuerpos.

Aflojar los tornillos prisioneros de la bisagra inferior (1,2a,2b,3a,3b). Cerrar el tornillo prisionero 5 y después el 4 de la bisagra superior. Pinzar el vidrio mediante las tapas y los tornillos. Alinear la puerta con los tornillos prisioneros 2a y 2b hasta cerrarlos completamente. Con la regulación completa, bloquear los prisioneros 3a y 3b. Abrir la puerta a 90° y cerrar el tornillo prisionero 1. Cierrar la puerta. Regular la velocidad de cierre y de frenado mediante los tornillos de regulación (ver página siguiente). Fijar a presión las tapas embellecedoras.

Fix the angular brackets (floor/wall item 8201; ceiling/wall item 8202) and then thread the bodies. Maintain the dowels of bottom hinge (1, 2a, 2b and 3a and 3b) loosen up. Fasten the dowel nr. 5 and then dowel nr. 4 of dissipator. Clamp the glass using the appropriate plates and screws. Align the door through the dowels 2a and 2b since they are completely fastened.

When the adjustment is completed, block fastening dowels 3a and 3b. Open the door at 90° and fasten dowel 1. Close again the door. Adjust the speed of closing and of dissipation using the appropriate valves (see back page). Apply pressure covering timing case.

Die Winkel (Fußboden/Wand Art. 8201; Decke/Wand Art. 8202) fixieren und danach die Körper einsetzen. Die Stifte des unteren Scharniers (1, 2a, 2b, 3a und 3b) locker lassen. Den Stift 5 und danach den Stift 4 des Anpralldämpfers festziehen. Die Glasscheiben mit den entsprechenden Montageplatten und Schrauben fixieren. Die Türausrichtung über die Stifte 2a und 2b vornehmen, bis diese komplett festgezogen sind. Nach der erfolgten Regelung die Stifte 3a und 3b festziehen. Die Tür auf 90° öffnen und den Stift 1 festziehen. Die Tür wieder schließen. Die Schließgeschwindigkeit und die Bremskraft über die entsprechenden Düsen regeln (siehe Rückseite). Die Abdeckungen aufstecken.

Fixer les équerres (étage/mur art.8201; plafond/mur art.8202) et successivement enfiler les corps. Insérer les vis de la charnière inférieure (1, 2a, 2b e 3a e 3b). Serrer la vis 5 puis la 4. Fixer le verre à l'aide des plaques et vis spéciales. Effectuer l'alignement de la porte sur les vis 2a et 2b jusqu'à ce qu'elles soient complètement fixées. Le réglage est fini une fois que la porte est complètement bloquée en serrant les vis 3a et 3b. Ouvrir la porte à 90° et serrer la vis 1. Refermer la porte. Régler la vitesse de fermeture et de dissipation à l'aide des buses appropriées (voir page suivante). Appliquer une pression couvrant le carter de distribution.

REGOLAZIONE DEGLI UGELLI

• CERNIERA INFERIORE (ART.8201) *ACCELERAZIONE = SVITARE, DECELERAZIONE = AVVITARE*

APRIRE LA PORTA IN POSIZIONE DI APERTURA 60°-70°. POI LASCIARLA LIBERA E VALUTARE LA VELOCITÀ CON CUI SI CHIUDE: SVITANDO L'UGELLO DI REGOLAZIONE E RIPETENDO L'OPERAZIONE SOPRA, IMPOSTARE LA VELOCITÀ DI CHIUSURA DESIDERATA.

ATTENZIONE: APERTURE VIOLENTE OLTRE I 95° POTREBBERO CAUSARE LO SCARDINAMENTO. È CONSIGLIABILE L'APPLICAZIONE DI UN FERMAPORTA.

• DISSIPATORE SUPERIORE (ART.8202) *MINORE FORZA FRENANTE = SVITARE, MAGGIORE FORZA FRENANTE = AVVITARE*

PER REGOLARE IL FRENO IN CHIUSURA APRIRE LA PORTA IN POSIZIONE APERTA 60°-70° ACCOMPAGNANDO LA PORTA IN CHIUSURA QUESTA DEVE RISULTARE LIBERA, MENTRE CHIUDENDO IN MANIERA BRUSCA QUELLO CHE SI DOVRÀ PERCEPIRE SARÀ UNA LEGGERA RESISTENZA.

ATTENZIONE: NON REGOLARE IL FRENO FRENANDO ECCESSIVAMENTE LA PORTA. LA SUA FUNZIONE È QUELLA DI RALLENTARE LA CHIUSURA QUALORA LA PORTA FOSSE SPINTA DAL VENTO.

N.B. ATTENZIONE! NON SVITARE MAI DEL TUTTO GLI UGELLI (FUORI USCITA OLIO IN PRESSIONE!). NON RISPONDIAMO DI EVENTUALI RESI CON UGELLO SVITATO.

REGULACIÓN DE LAS VÁLVULAS

• BISAGRA INFERIOR (ART.8201) *MAYOR ACELERACIÓN = DESATORNILLAR, MENOR ACELERACIÓN = ATORNILLAR*

CADA BISAGRA DISPONE DE UN TORNILLO ALLEN SITUADO A LA VISTA EN UNO DE LOS LATERALES. PARA FACILITAR LA REGULACIÓN DE CIERRE DEL SISTEMA, COLCOM ENTREGA LA BISAGRA INFERIOR(8201), CON SU TORNILLO DE REGULACIÓN COMPLETAMENTE ATORNILLADO. APERTURA VIOLENTA ADEMÁS DE 95°, PODRÍA CAUSAR DAÑO. ACONSEJAMOS UTILIZAR UN FIJA PUERTA.

• BISAGRA SUPERIOR (ART.8202) *MINOR FUERZA DE FRENADO = DESATORNILLAR, MAYOR FUERZA DE FRENADO = ATORNILLAR*

POR EL CONTRARIO LA BISAGRA SUPERIOR (8202), SE ENTREGA CON EL TORNILLO DE REGULACIÓN ABIERTO. UNA VEZ INSTALADO EL SISTEMA TRILOBA, PROCEDAMOS A SU REGULACIÓN. ABRIMOS LA PUERTA 60°-70°, DESATORNILLAMOS 1/8 DE VUELTA, (APROX) DE LA BISAGRA INFERIOR(8201), DEJAMOS CERRAR LA PUERTA Y OBSERVAMOS SU VELOCIDAD DE CERRADO. LA PUERTA DEBE TRASPASAR EL PUNTO 0°, 25-30 CM. (APROX). HEMOS DADO A LA PUERTA UNA VELOCIDAD DE CERRADO EXCESIVA. AHORA CORREGIMOS LA VELOCIDAD DE CERRADO, ATORNILLANDO LA BISAGRA SUPERIOR (8202), HASTA QUE CONSIGAMOS QUE NUESTRA PUERTA QUEDE PARADA EN EL PUNTO 0°. QUEREMOS DEJAR CLARO QUE EL SISTEMA TRILOBA SE BASA EN UN EQUILIBRIO ENTRE LA VELOCIDAD QUE IMPRIME LA BISAGRA INFERIOR (8201) PARA EL CIERRE DE LA PUERTA Y LA ACCIÓN CONTRARIA DE FRENADO QUE APORTA LA BISAGRA SUPERIOR(8202). LOS TORNILLOS DE REGULACIÓN DEL SISTEMA DE CIERRE TRILOBA, NO SE DEBEN DESATORNILLAR TOTALMENTE, EL ACEITE PUEDE SALIR POR PRESIÓN.

N.B. COLCOM NO REPONE LAS BISAGRAS CON LA TOBERA DE AJUSTE DESATORNILLADA. APERTURA VIOLENTA ADEMÁS DE 95°, PODRÍA CAUSAR DAÑO. ACONSEJAMOS UTILIZAR UN FIJA PUERTA.

ADJUSTMENT OF THE NOZZLES

• BOTTOM HINGE (ITEM CODE 8201) *ACCELERATION = LOOSEN, DECELERATION = TIGHTEN*

OPEN THE DOOR AT THE 60°-70° POSITION, TURN LOOSE AND DETERMINE THE SPEED WHICH IS CLOSING: IN ORDER TO REACH THE DESIRED CLOSING SPEED, LOOSE THE ADJUSTMENT NOZZLE AND REPEAT THE ABOVE MENTIONED OPERATION.

NOTE: ATTENTION! FURTHER THAN 95° COULD UNHINGE THE DOOR. WE SUGGEST TO INSTALL A DOOR STOP.

• UPPER DISSIPATOR (ITEM CODE 8202) *LOWER BRAKE-FORCE = TO LOOSEN, LARGER BRAKE-FORCE = TO TIGHTEN*

IN ORDER TO ADJUST THE BRAKE WHILE CLOSING, OPEN THE DOOR AT THE 60°-70° POSITION; SUPPORT THE DOOR WHILE CLOSING, THE DOOR WILL BE FREE, WHILE PULLING IN OFFHAND WAY, YOU WILL FEEL A LIGHTLY RESISTANCE.

ATTENTION: DO NOT ADJUST THE BRAKE EXCESSIVELY. IT FUNCTION IS TO DECREASE THE CLOSING IF THE DOOR IS PUSHED BY THE WIND.

NOTE: ATTENTION! NEVER LOOSEN THROUGH AND THROUGH THE NOZZELS (RUN OUT OF OIL UNDER PRESSURE) AS WE ARE NOT LIABLE FOR ANY RETURN BY LOSING NOZZLE.

REGELUNG DER DÜSEN

• UNTERES SCHARNIER (ART. 8201) *BESCHLEUNIGUNG = AUSSCHRAUBEN, VERZÖGERUNG = EINSCHRAUBEN*

DIE TÜR SOLL ZU 60°-70° GEÖFFNET SEIN, DANN DIE TÜR FREI LASSEN UND DIE GESCHWINDIGKEIT DER SCHLISSUNG. UM DIE GEWÜNSCHTE GESCHWINDIGKEIT DER SCHLISSUNG ZU ERREICHEN, DIE REGELDÜSE AUSSCHRAUBEN UND DIE OBEN GENANNTEN AKTION WIEDERHOLEN. ACHTUNG: HEFTIGE ÖFFNUNGEN MEHR ALS 95° KÖNNTEN DIE TÜR AUSHEBEN. WIR SCHLAGEN DIE INSTALLIERUNG EINES TÜRHALTERS VOR.

• OBERER ANPRALLSDÄMPFER (ART. 8202) *GERINGERE BREMSKRAFT = AUSSCHRAUBEN, HÖHERE BREMSKRAFT = EINSCHRAUBEN*

UM DIE SCHLISSBREMSE ZU REGELN, DIE TÜR ZU 60°-70° ÖFFNEN BEIM BEGLEITEN DER TÜR WÄHREND DES SCHLISSVORGANGS, SIE WIRD FREI SEIN, WÄHREND BEI RUCKARTIGEN SCHLISSEN EINE GEGENWIRKUNG SPÜRBAR SEIN WIRD. DIESE GEGENWIRKUNG WIRD HÖHER SEIN, WENN DIE REGELDÜSE KOMPLETT EINGESCHRAUBT WIRD UND UMGEKEHRT WENN MAN DIE REGELDÜSE AUSSCHRAUBT.

ACHTUNG: DIE BREMSE NICHT ÜBERMÄSSIG EINSTELLEN. SIE DIENT DAZU, DAS SCHLISSEN ZU VERLANGSAMEN, WENN DIE TÜR VOM WIND GEDRÜCKT WIRD.

N.B.: ACHTUNG! DIE DÜSEL NIE KOMPLETT AUSSCHRAUBEN, SONST WIRD DAS ÖL UNTER DRUCK RAUS KOMMEN!! IN DIESEM FALL WERDEN WIR FÜR RETURNLIEFERUNGEN MIT AUSGESCHRAUBTER DÜSE NICHT HAFTEN.

REGLAGE DES FREINS

• CHARNIERE INFÉRIEURE (ART.8201) *ACCELERATION = DEVISSER, DECELERATION = SERRER*

OUVRIR LA PORTE A 60°-70°, LA LAISSER SE REFERMER ET EVALUER LA VITESSE DE FERMETURE: DEVISSER LA BUSE DE REGLAGE ET REPETER L'OPERATION, INSTALLER LA VITESSE DE REGLAGE DESIREE.

ATTENTION:UNE OUVERTURE VIOLANTE A PLUS DE 95° POURRAIT CAUSER UNE SORTIE DES GONDS. IL EST RECOMMANDER D'APPLIQUER UNE BUTEE.

• DISSIPATEUR SUPERIEUR (ART.8202) *FORCE DE FREINAGE MINEURE = DEVISSER, FORCE DE FREINAGE MAJEURE = VISSER*

POUR REGLER LE FREIN DE FERMETURE PLACER LA PORTE EN POSITION D'OUVERTURE 60°-70° EN ACCOMPAGNANT LA PORTE EN FERMETURE ELLE DEVRAIT ETRE LIBRE, ALORS QU'EN LA FERMANT DE MANIERE BRUSQUE VOUS DEVRIEZ ENTENDRE UN BRUIT DE RESISTANCE.

ATTENTION: NE PAS REGLER LE FREIN EN FERMANT EXCESSIVEMENT LA PORTE. SON FONCTIONNEMENT PERMET DE TALENTIR LA FERMETURE LORSQUE LA PORTE EST REFERMEE PAR LE VENT.

N.B. ATTENTION ! NE PAS DEVISSER LES BUSES (DESCENTE DE LA PRESSION D'HUILE). NOUS NE REPONDONS PAS D'EVENTUELS RETOURS AVEC BUSES DEVISSES.

cerniere oleodinamiche / oildynamic hinges

Biloba Unica



101E10



Alluminio / Aluminium - finiture / colors 02-05-14-15-16-17-31-32-40

Nasce per le porte esterne, ma il suo formato e design minimale ne consentono l'applicazione in qualsiasi ambiente. Si distingue per la semplicità e rapidità di installazione a terra e può soddisfare anche applicazioni a bilico. Biloba UNICA è abbinabile a tutti i patch fittings esistenti sul mercato ed alla cerniera superiore serie Maxima. Biloba Unica prevede cerniere superiori con le stesse dimensioni e design, sia con attacco a muro che per sopraluca (art.100E20 e art.100E 25).

Ha sido creada para puertas exteriores, pero su formato y su diseño minimalista permiten aplicarla en cualquier ambiente. Se distingue por ser sencilla y rápida de instalar en el suelo; también puede utilizarse en aplicaciones basculantes. La bisagra "Biloba Unica" puede ser compatible con todos los "patch fittings" que existen en el mercado y también con la bisagra superior de la serie Maxima. La bisagra "Biloba Unica" se prevehe en dos modelos diferentes pero con el mismo tamaño y diseño, tanto para la sujeción a la pared cuanto para la sujeción a la luna. (art.100E 20 e art.100E 25)

Conceived for installation on exterior doors, this hinge features pure, essential design and is ideal for installation in any type of setting. It is extremely quick and easy to install in floor and pivot doors as well. Biloba UNICA matches to every type of patch fitting existing on the market and to the top hinge of Maxima series. For those who are most demanding, Biloba UNICA may have top hinges



100E20



A100E40 + 100E25

Alluminio / Aluminium - finiture / colors 02-05-14-15-16-17-31-32-40

with same dimensions and design, both with wall and transom mounting (item 100E 20 and item 100E 25)

Es wurde für die Außentüren konzipiert, doch seine Größe und sein Minimal Design ermöglichen eine Anwendung in jeglichen anderen Bereichen. Es zeichnet sich durch eine mühelose und schnelle Installation am Boden aus und ist auch für Anwendungen mit Schwingtüren geeignet. Biloba UNICA ist zu allen Arten von Patch Fitting auf der Markt und zum oberen Beschlag Serie Maxima kombinierbar. Für die anspruchsvollsten sieht Biloba Unica zwei oberen Beschläge mit selben Maßen und Design vor; sowohl mit Wandmontage als auch Montage am Oberlichtfenster (Art.100E 20 und Art.100E 25).

Conçue pour une installation sur porte extérieure, cette charnière au design épuré et moderne convient à tout type d'application. Le montage est simple et rapide, au sol ou sur porte pivotante. Biloba UNICA ne nécessite qu'un seul perçage au sol. Elle dispose des avantages d'un frein de sol et d'une fermeture automatique. Cette charnière peut être associée à toute peinture et charnière du marché et aux charnières supérieures de la gamme Maxima. Nous recommandons deux peintures hautes qui s'associent parfaitement à ce système de par un design et des dimensions similaires, pouvant être installées au plafond ou sur imposte : 100E20 et 100E25.





101E10

Biloba Unica

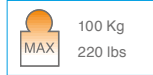
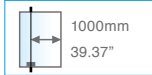
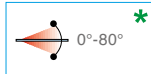

- Cerniera oleodinamica, integrata di freno e regolazioni della velocità di chiusura e dello scatto finale dell'anta. Abbinabile anche con tutti i patch fittings della serie Maxima. Utilizzabile anche per applicazioni pivotanti. Stop a 0° +90° -90°.
- Bisagra automática hidráulica, integrada de freno y ajuste de velocidad de cierre y de disparo final de la puerta. Combinable con todos los herrajes producidos de serie Maxima. Utilizable también en aplicaciones con "punto de giro". Stop a 0° +90° -90°.
- Hydraulic hinge including brake, closing speed & final latch adjustments. Can be combined with all patch fittings of the Maxima series. Useful also for pivoting applications. Stop at 0° +90° -90°.
- Hydraulikscharnier mit Bremse, Feststellung der Türschließgeschwindigkeit und Feststellung der Endauslösung der Tür. Passend zu allen Produkten der Maxima Serie. Auch für schwenkenden Installationen geeignet. Feststellung bei 0°+90°-90°.
- Charnière hydraulique, avec frein et réglage de la vitesse de fermeture et de verrouillage. Combinable avec toutes les fixations de raccord de la série Maxima. Utilisable pour application pivotante. Arrêt à 0°, +90° et -90°.

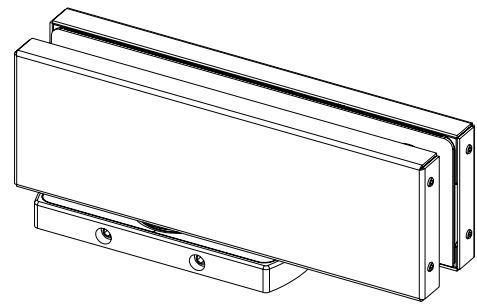

*

L'automatismo di chiusura inizia a operare entro un range compreso tra 70° e 80°. La chiusura è soft per i primi 20°, e regolabile con controllo dai 60° fino a chiusura completa - El automatismo de cierre, comienza a funcionar dentro de un rango entre 70° y 80°. El cierre es suave para los primeros 20° y ajustable con control, de 60° hasta el cierre completo - The closing automatism kicks in within 70°-80° range. The closing is soft for the first 20° and becomes speed-adjustable from 60° up to complete closing. - Die automatische Schließvorrichtung aktiviert sich zwischen 70° und 80°. Die Schließung ist weich für die ersten 20° und justierbar mit Kontrolle ab 60° und bis Komplettschließung - L'automatisme de fermeture commence à fonctionner dans une gamme incluse entre 70° e 80°. La fermeture est lente pour les premiers 20°, et réglable avec contrôle dès 60° jusqu'à la fermeture complète

DISPONIBILE ANCHE NELLA VERSIONE "L" LIGHT CON MOLLA DEPOTENZIATA PER PORTE DI LARGHEZZA INFERIORE A 600 MM. Versione da specificare in fase d'ordine e soggetta a possibili minimi d'ordine. Per ulteriori informazioni contattare l'ufficio commerciale - TAMBÉN DISPONIBLE "L" LIGHT - MUELLE CON MENOS FUERZA PARA PUERTAS INFERIORES A 600MM DE ANCHO. Se tendrá que especificar en los pedidos y ser objeto de pedido mínimo. Nuestra oficina comercial está a su disposición para ampliar esta o cualquier otra información. - ALSO AVAILABLE IN "L" LIGHT VERSION WITH POWER-DOWNGRADED SPRING FOR DOORS WITH LESS THAN 600 MM. Both must be specified when ordered and may be subject to a minimum quantity order. For further info, please contact our export dept. - ES IST AUCH IN VERSIONE VERFÜGBAR "L" LIGHT MIT SCHWÄCHERER FEDER FÜR TÜREN UNTER 600 MM BREITE. Beide sind bei der Bestellung anzugeben und können eine mindestbestellmenge verlangen. Für weitere Informationen setzen sie sich mit unserer exportabteilung im kontakt. - DISPONIBLE EGALMENT EN VERSION "L" LIGHT AVEC UNE FERMETURE RÉDUITE POUR LES PORTES DE LARGEUR INFÉRIEURE A 600 MM. Versions à préciser lors de la commande, éventuellement soumises à des quantités minimum. Pour plus d'informations, veuillez contacter le service commercial

Classificazione secondo normativa - Clasificación según la ley - Classification according to int'l regulation - Klassifizierung nach den Vorschriften - Classification selon la norme							
art. 101E 10	EN 1154 : 2006	4	8	3/5	0	1	4

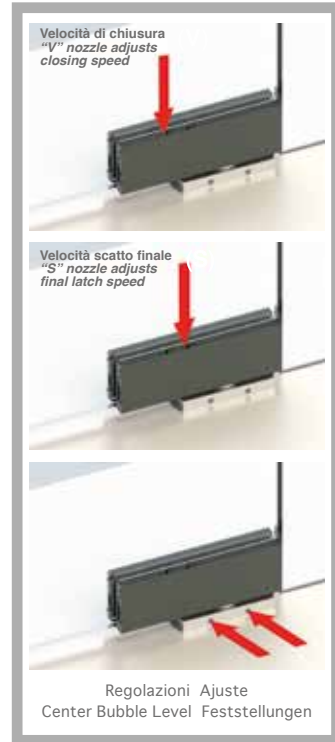
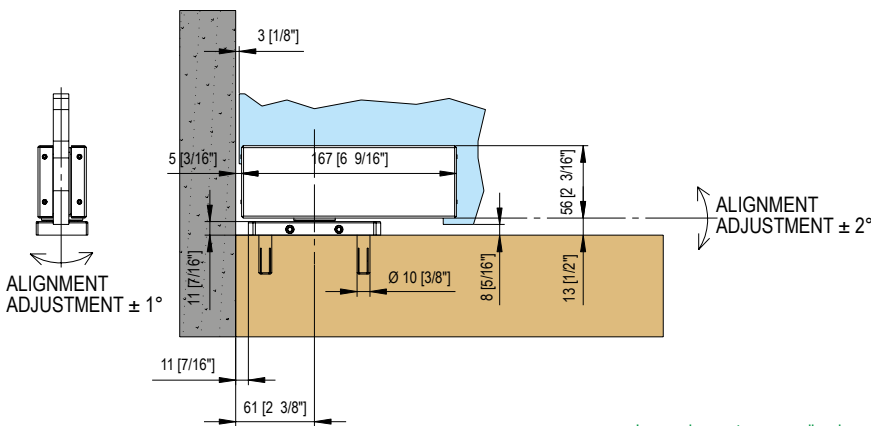
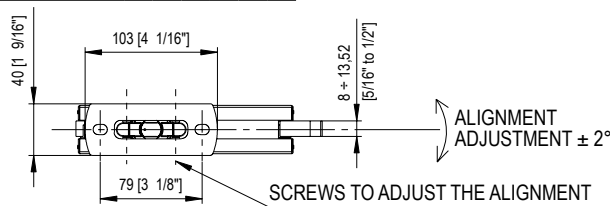

Lavorazione vetro per applicazione pivotante - Labrado del vidrio en aplicación con "punto de giro" - Glass processing for pivoting applications - Glasbearbeitung für schwenkende Installation - Transformation du verre pour application pivotante

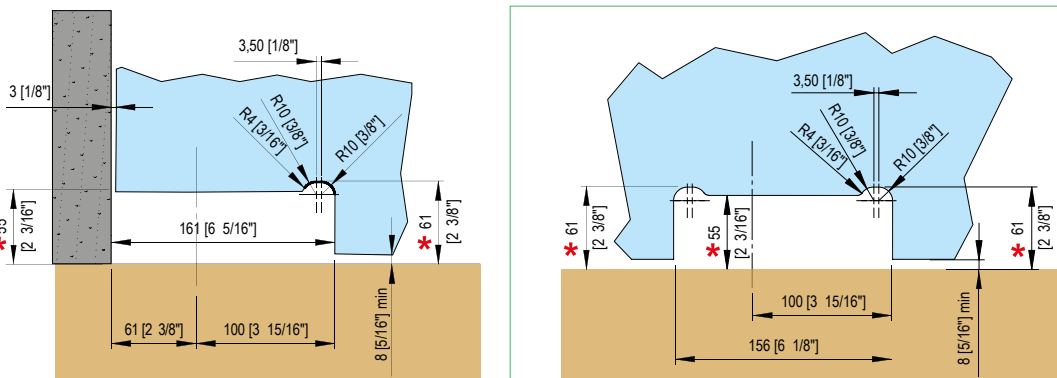

* DISTANZA DA TERRA - DISTANCIA DESDE EL SUELO - DISTANCE FROM THE FLOOR - ABSTAND VOM BODEN- DISTANCE AU SOL

100E20

Biloba Unica

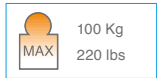
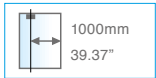

- Cerniera superiore.
- Bisagra superior.
- Top hinge.
- Oberes Band.
- Charnière supérieure.

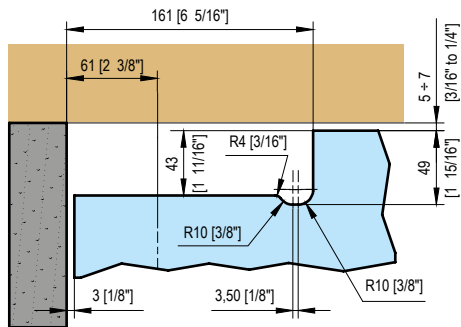
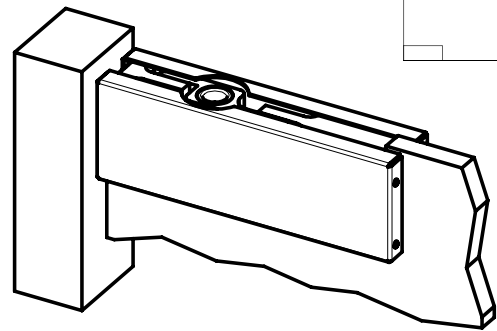
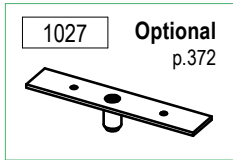
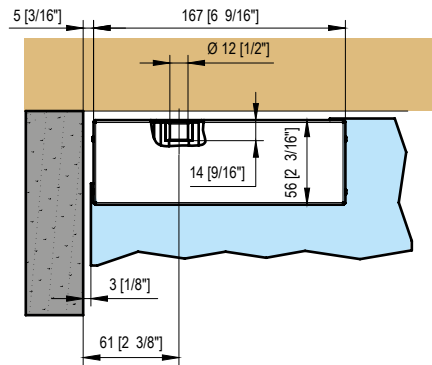
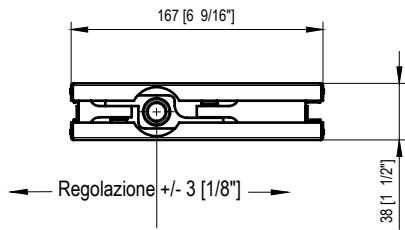
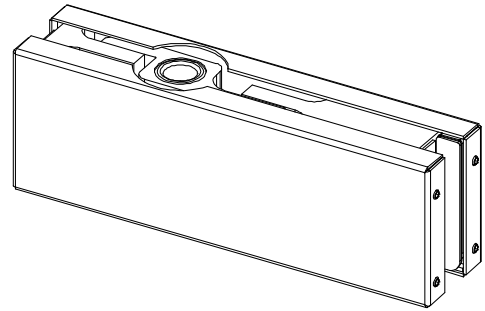

Lavorazione vetro per applicazione pivotante - Labrado del vidrio en aplicación con "punto de giro" - Glass processing for pivoting applications - Glasbearbeitung für schwenkende Installation Transformation du verre pour application pivotante

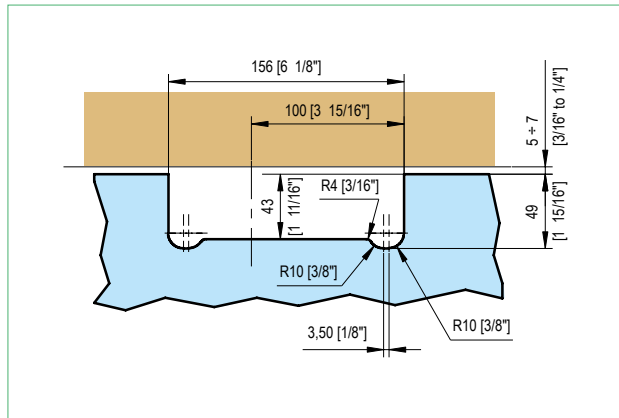

100E25

Biloba Unica

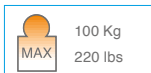
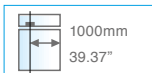

- Attacco sopraluce per art.100E20.
- Enganche de giro montante para art.100E20.
- Transom link fitting for item 100E20.
- Kupplung für Oberlichtfenster für art.100E20.
- Imposte art.100E 20.

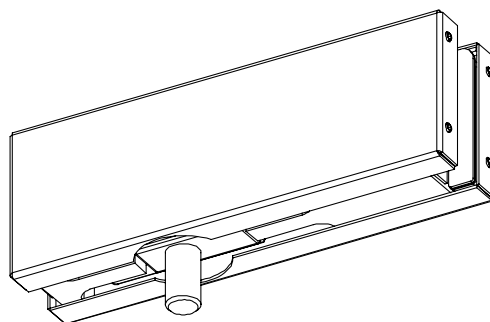

A100E40

Biloba Unica

- Piastrina per attacco a muro per art.100E25.
- Accesorio para la fijación a pared para art.100E25.
- Wall fixing accessory for item 100E25.
- Zubehör für Wandfixierung für Art.100E25.
- Plaque pour montage mural art.100E25.

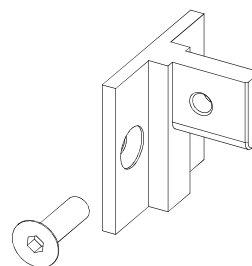

APPLICAZIONE - APLICACIÓN - APPLICATION - ANWENDUNG - APPLICATION

100E25

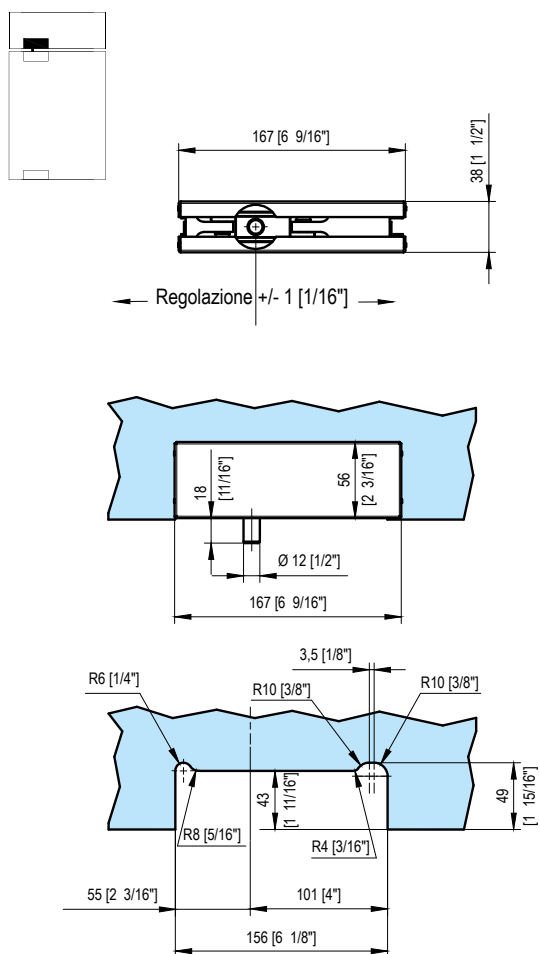

APPLICAZIONE - APLICACIÓN - APPLICATION - ANWENDUNG - APPLICATION

100E25 + A100E40

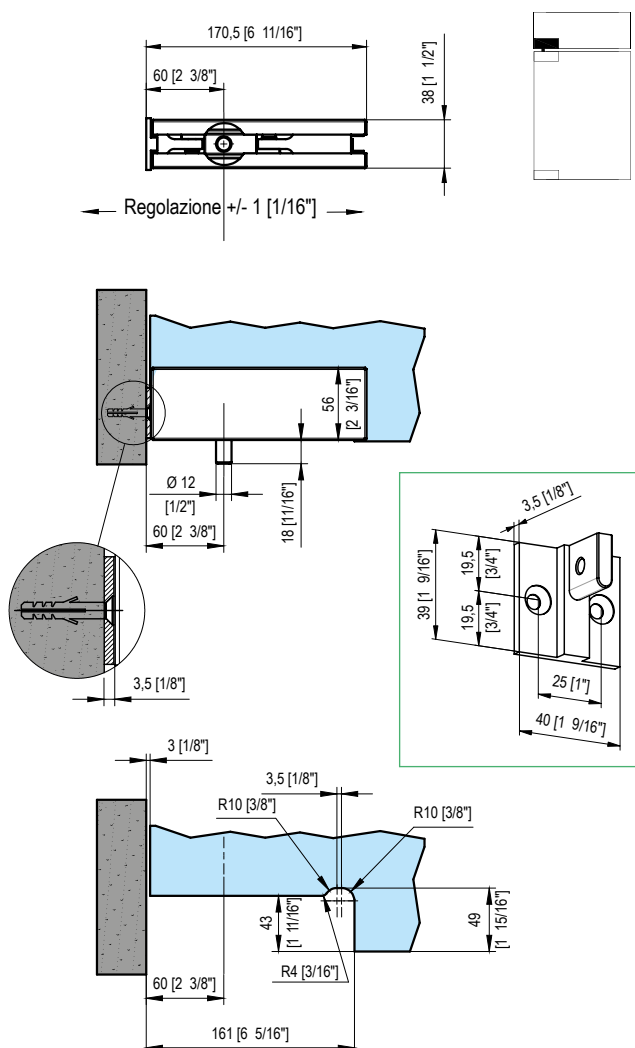

cerniere e attacchi sopra luce / hinges and patch fittings

serie Maxima

finiture / colors 02-05-14-15-16-31-32-40

Alluminio / Aluminium



1010

Alluminio / Aluminium



1011

Alluminio / Aluminium



1012

Alluminio / Aluminium



1020

Alluminio / Aluminium



1022

Acciaio Inox / Stainless Steel



1027

Ottone / Brass



1730 - 1732 - 1735

Alluminio / Aluminium



1030

Alluminio / Aluminium



1040

Alluminio / Aluminium



1050

Alluminio / Aluminium



1060

Alluminio / Aluminium



1065

Alluminio / Aluminium



1070

Alluminio / Aluminium



1075

Alluminio / Aluminium



1510

Alluminio / Aluminium



1520

Alluminio / Aluminium



1522 finiture non disponibili
colors not available 02-05

Ottone / Brass

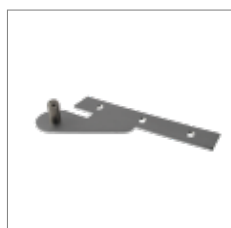

1527 finiture non disponibili
colors not available 02-05

Alluminio / Aluminium



1518

Alluminio / Aluminium



1528

Alluminio / Aluminium



1810

Alluminio / Aluminium



1820

Alluminio / Aluminium



1825

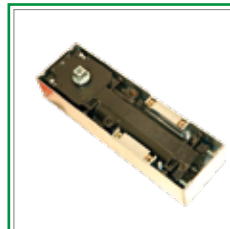

CHD1
Chiudiporta / Floor spring

1010

- Cerniera inferiore con quadro italiano a 57-67mm.
- Pernio inferior con cuadro italiano de 57-67mm.
- Bottom pivot patch with Italian pivot housing at 57-67mm.
- Unteres Band mit 57-67mm italienischer Gehäuse.
- Charnière inférieure avec cadre italien a 57-67mm.

1011

- Cerniera inferiore con tassello rettangolare tedesco.
- Pernio inferior con taco rectangular aleman de 57-67mm.
- Bottom pivot patch with German pivot at 57-67mm.
- Unteres Band mit 57-67mm deutscher Gehäuse.
- Charnière inférieure avec pièces rectangulaires allemandes.

1012

- Cerniera inferiore con tassello rettangolare spagnolo.
- Pernio inferior con taco rectangular español de 57-67mm.
- Bottom pivot patch with Spanish pivot at 57-67mm.
- Unteres Band mit 57-67mm spanischer Gehäuse.
- Charnière inférieure avec pièces rectangulaires espagnoles.

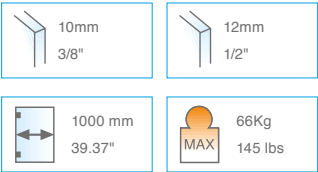

Da specificare all'ordine
Please specify in detail
when ordering

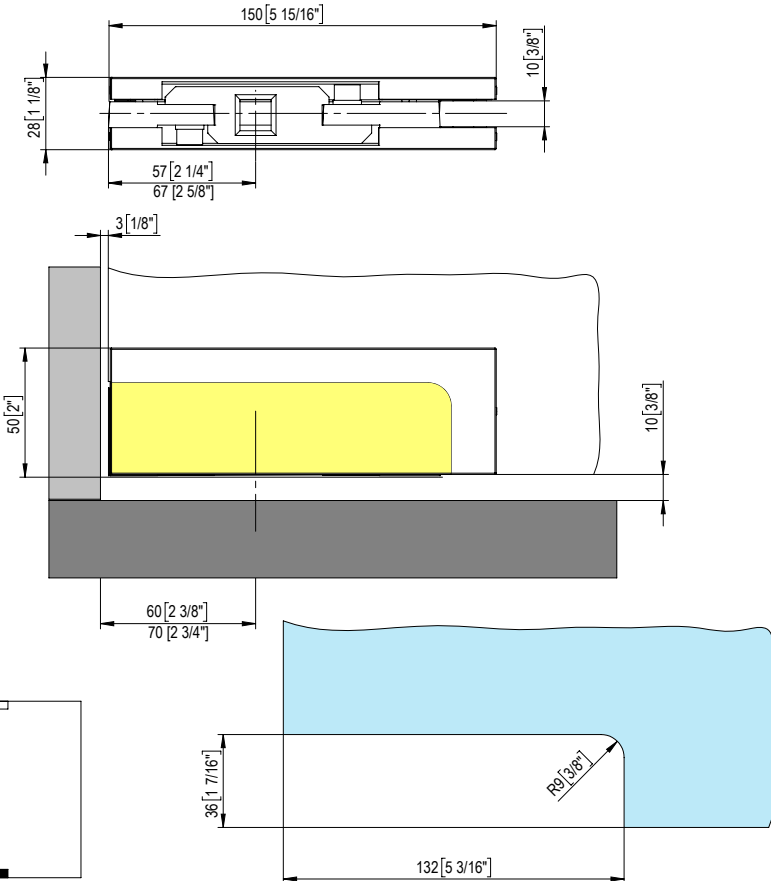
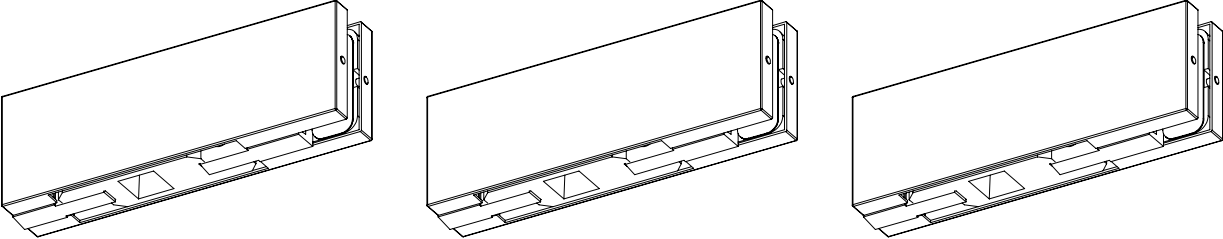

1020

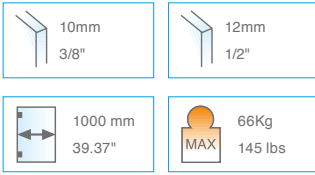

Da specificare all'ordine
Please specify in detail
when ordering

- Cerniera superiore cuscinetto a 57-67mm registrabile.
- Pernio superior de 57-67mm
- Top pivot patch with adjustable bearing bush at 57-67mm.
- Oberes Band mit 56-67mm vertellbarem Lager.
- Charnière supérieure 57-67mm réglable.

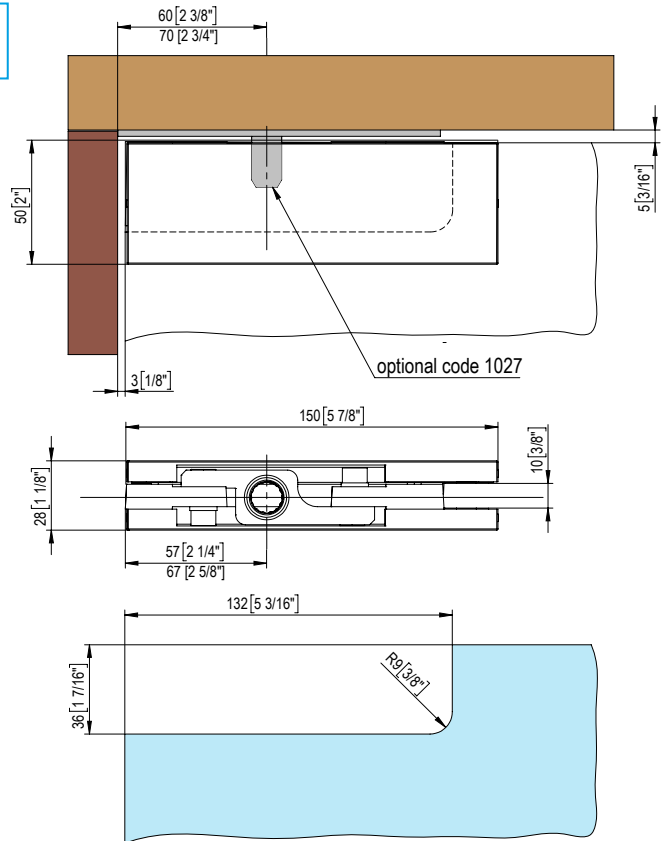
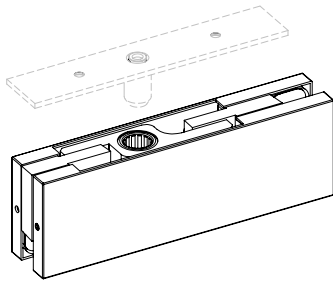

1022

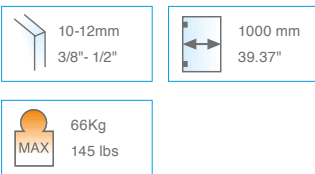

- Cerniera laterale per porte senza attacchi al soffitto, con perno a 57 mm. Abbinabile all'art.1010.
- Bisagra lateral por puerta sin enganche al techo. Con pernio a 57 mm. Se puede acoplar con art.1010.
- Side hinge for doors without ceiling fixings, with pivot pin at 57 mm. Combined to item.1010.
- Seitliches Band für Türen ohne Decke- festigungen, mit Zapfen 57 mm. Mit Art.1010 kombinierbar.
- Charnière latérale pour porte sans attaches au plafond, avec goupille de 57 mm. Combinable avec l'art.1010.

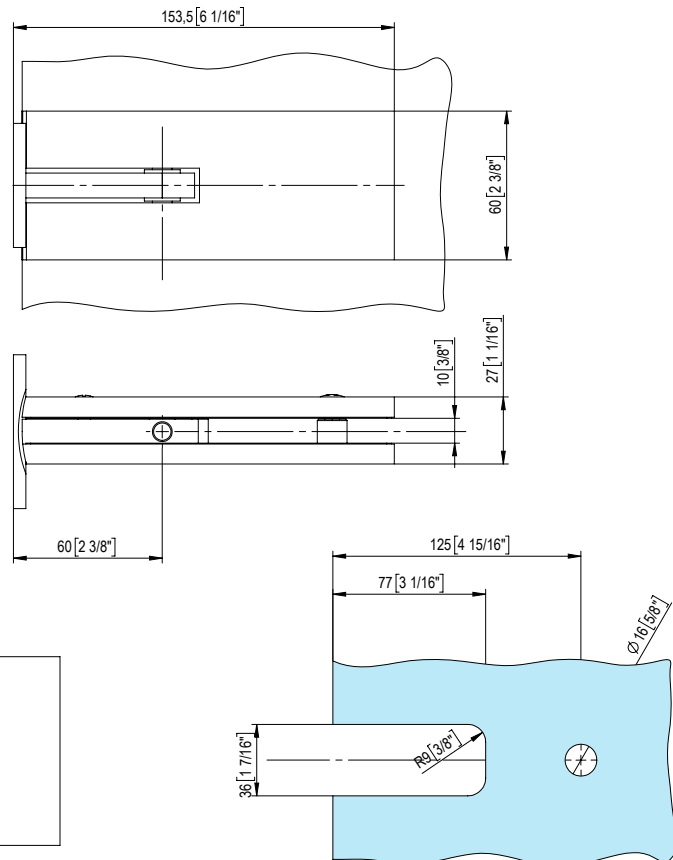
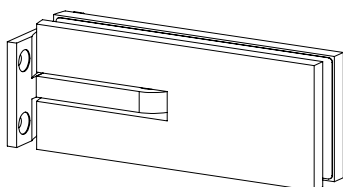

1730

- Piletta per cerniera. Quadro italiano.
- Punto de giro inferior con cuadro italiano.
- Bottom pin for hinges with Italian pivot housing.
- Unterer Zapfen für Band. Italienscher Gehäuse.
- Axe de pivot Italien.

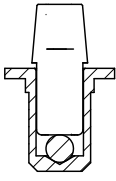
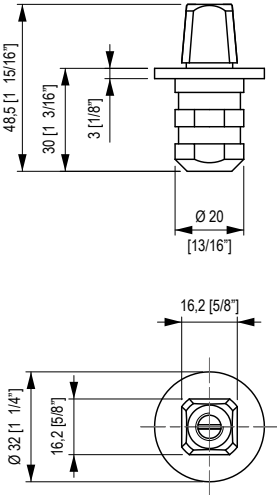
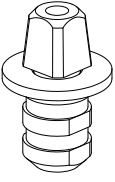

1732

- Piletta per cerniera. Quadro spagnolo.
- Punto de giro inferior cuadro Español.
- Bottom pin for hinges with Spanish pivot housing.
- Unterer Zapfen für Band. Spanischer Gehäuse.
- Axe de pivot espagnol.

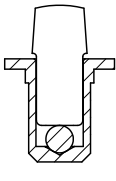
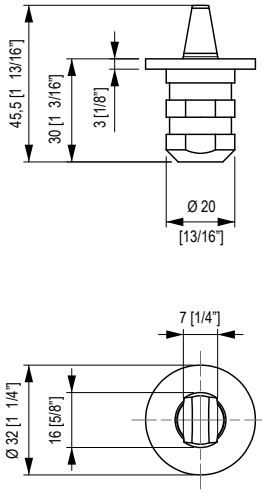
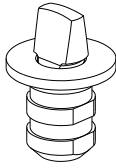

1735

- Piletta per cerniera. Quadro tedesco.
- Punto de giro inferior para bisagra con cuadro Aleman.
- Bottom pin for hinges with German pivot housing.
- Unterer Zapfen für Band. Deutscher Gehäuse.
- Axe de pivot allemand.

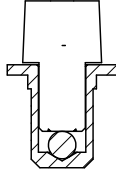
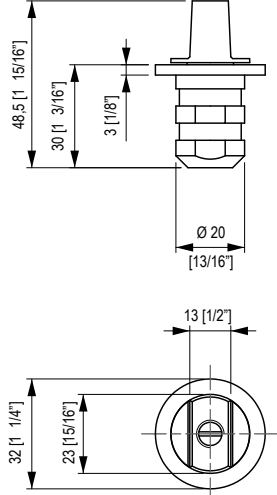
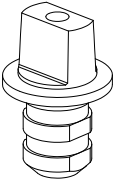

1027

- Piletta a soffitto per 1020-1820.
- Punto de giro superior para art.1020-1820.
- Top pin for 1020-1820.
- Deckezapfen für 1020-1820.
- Broche supérieure pour 1020-1820.

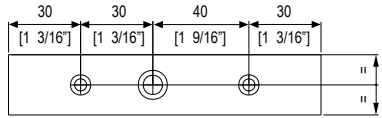
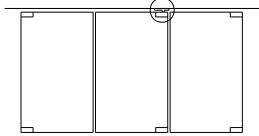
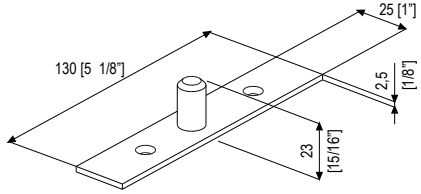

1030

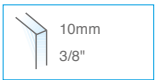

Da specificare all'ordine
Please specify in detail
when ordering

- Serratura stesse dimensioni della 1010 - 1020.
- Cerradura inferior: misma dimensión de 1010-1020.
- Corner lock. Same size and cut as 1010-1020.
- Schloss mit den selben Maßen von 1010-1020.
- Serrure. Mêmes dimensions et coupes que 1010 - 1020.

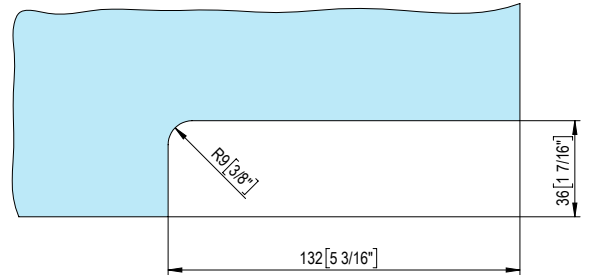
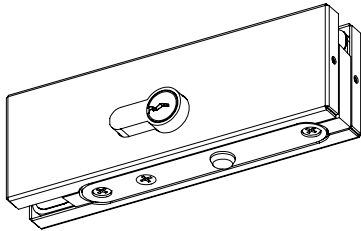
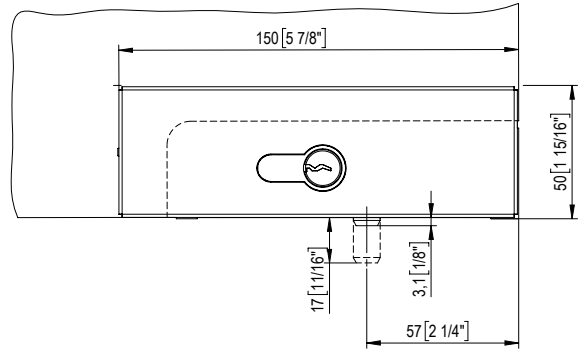
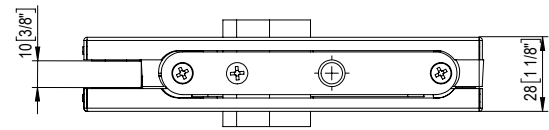
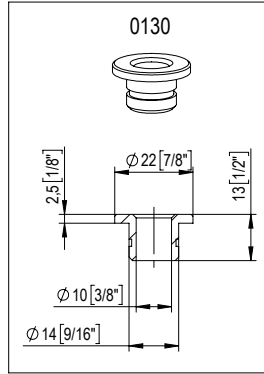

1040

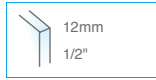
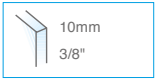

Da specificare all'ordine
Please specify in detail
when ordering

- Attacco sopra luce - muro per 1020.
- Enganche de giro montante -pared para art.1020.
- Transom to wall link fitting for 1020.
- Kupplung Oberlichtfenster-Wand für 1020.
- Fixation sous imposte- mur pour 1020.

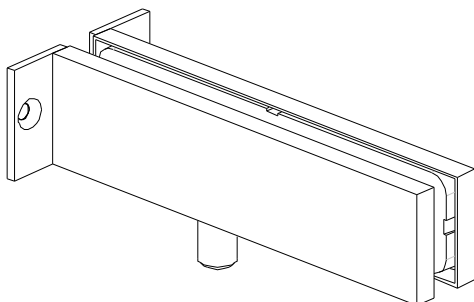
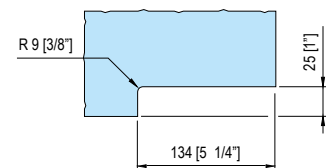
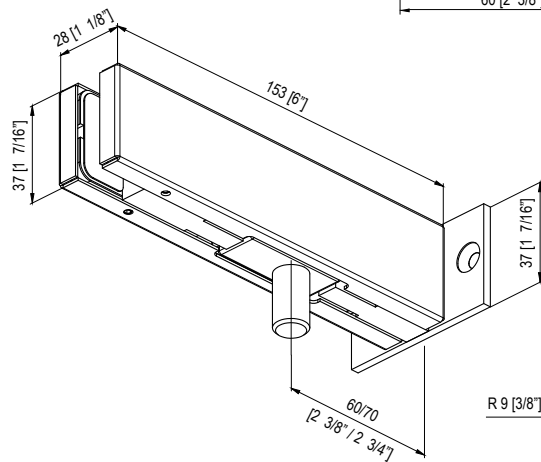
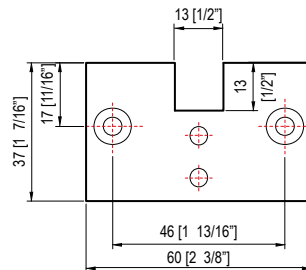

1050

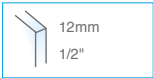
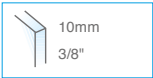

Da specificare all'ordine
Please specify in detail
when ordering

- Attacco sopra-luce-vello laterale per art.1020.
- Punto de giro montante lateral - vidrio fijo, para art. 1020.
- Transom to fixed side panel link fitting for 1020.
- Kupplung Oberlichtfenster-Seiten-teil für 1020.
- Fixation sous imposte - verre latéral pour art.1020.

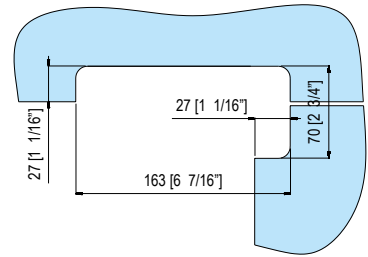
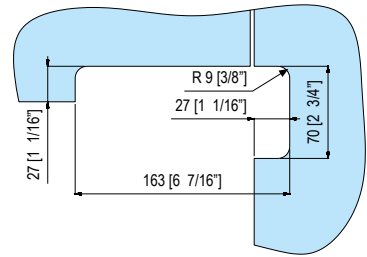
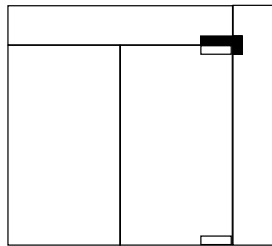
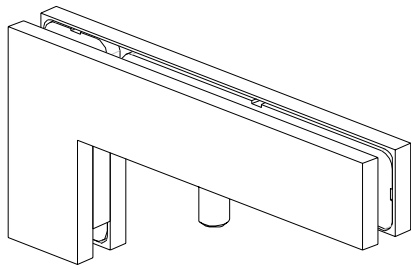

1060



Da specificare all'ordine
Please specify in detail
when ordering

- Attacco piccolo sopra-luce-vello fisso laterale con battuta.
- Unión tres lunas con tope.
- Small link fitting for transom to side panel with stop.
- Kleine Kupplung Oberlichtfenster-Seitenteil. Mit Anschlag.
- Petite fixation sous imposte - verre fixe latéral avec butée.

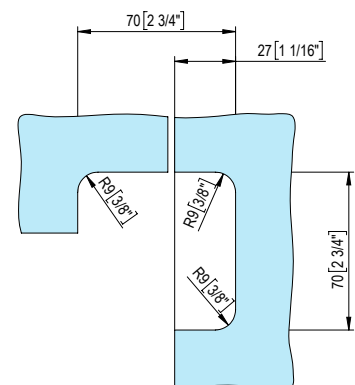
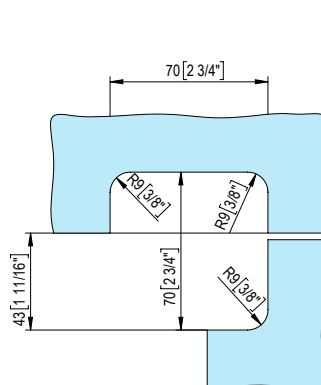
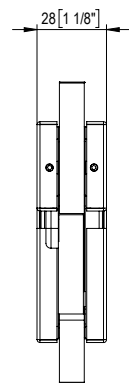
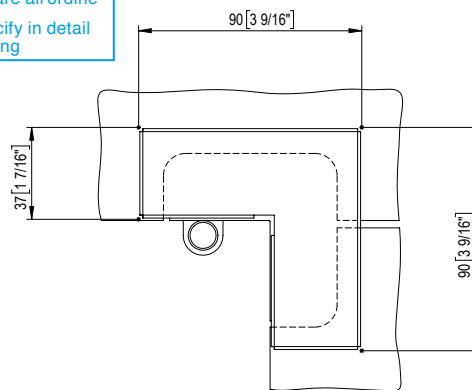
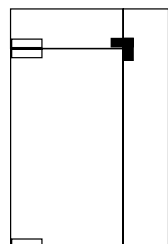
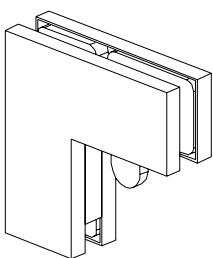

1065

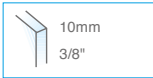

Da specificare all'ordine
Please specify in detail
when ordering

- Attacco piccolo sopra-luce-vello fisso laterale senza battuta.
- Unión tres lunas sin tope.
- Small link fitting for transom to side panel without stop.
- Kleine Kupplung Oberlichtfenster-Seitenteil. Ohne Anschlag.
- Petite fixation sous imposte - verre fixe latéral sans butée.

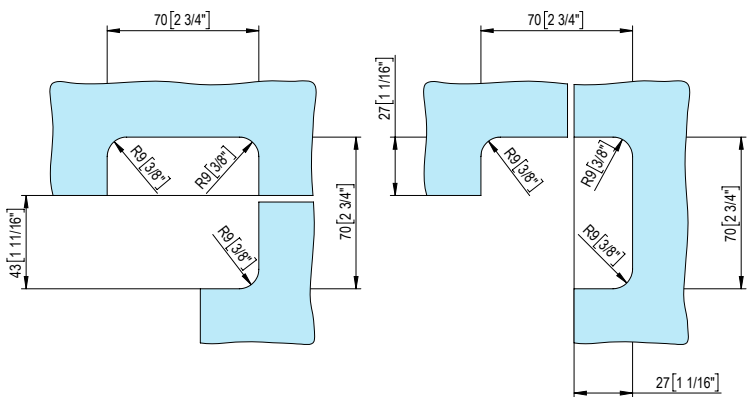
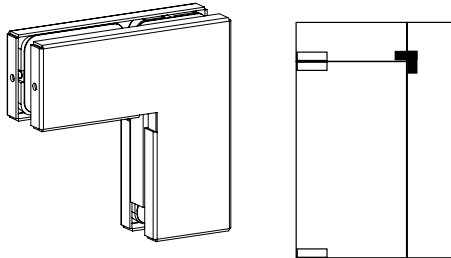
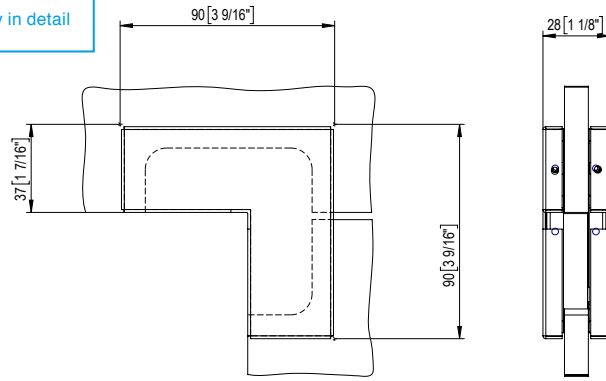

1070



Da specificare all'ordine
Please specify in detail
when ordering

- Attacco piccolo sopra-luce-muro con battuta.
- Unión una luna con tope.
- Small link fitting for transom to side panel with stop.
- Kleine Kupplung Oberlichtfenster-Wand. Mit Anschlag.
- Petite fixation sous imposte - verre fixe latéral sans butée.

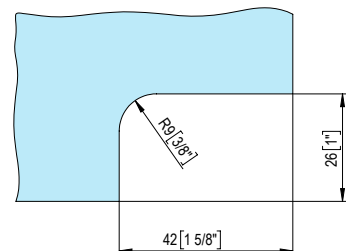
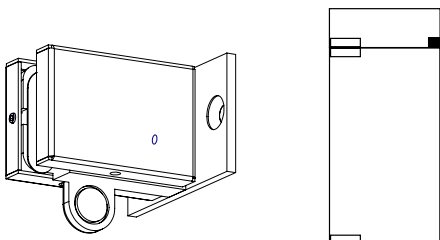
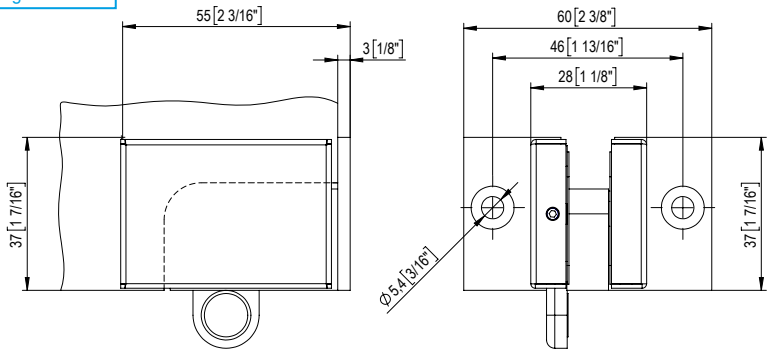

1075

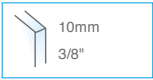

Da specificare all'ordine
Please specify in detail
when ordering

- Attacco piccolo sopra luce-muro senza battuta.
- Unión una luna sin tope.
- Small link fitting for transom to wall without stop.
- Kleine Kupplung Oberlichtfenster-Wand. Ohne Anschlag.
- Petite fixation sous imposte- mur sans butée.

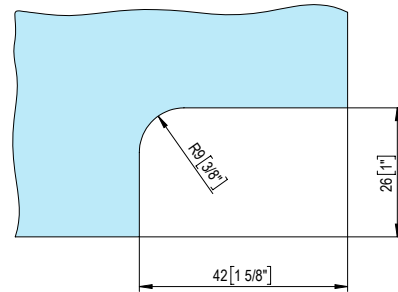
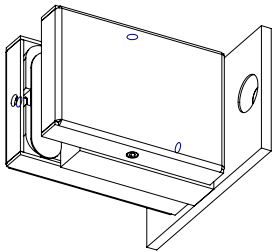
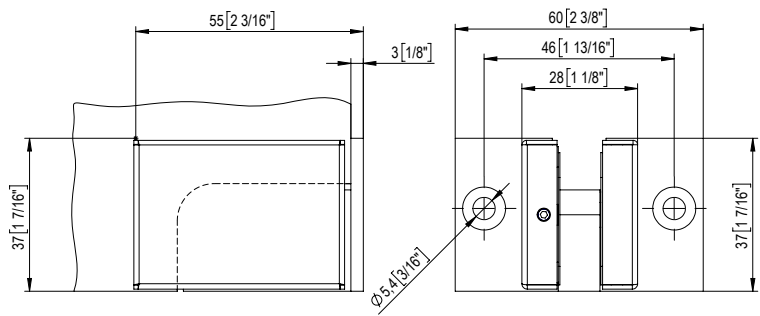

1510

1510R = destra - derecha - right - rechts - droite
1510L = sinistra - izquierda - left - links - gauche



Da specificare all'ordine
Please specify in detail
when ordering

- Cerniera inferiore con perno spostato(DX-SX).
- Pernio inferior con eje desplazado (DCH. - IZQ.).
- Bottom offset pivot patch. (right - left).
- Unteres Band mit seitlich angeschlagenem Zapfen. (rechts - links).
- Penture basse à axe déporté(DR-G)

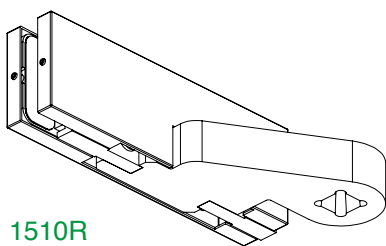
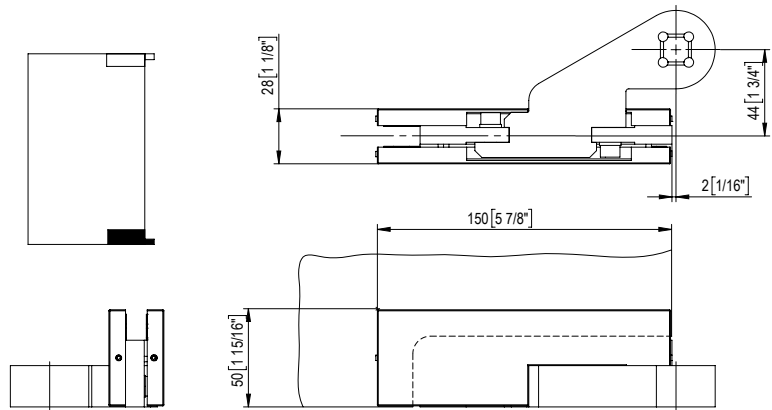



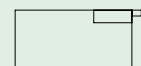
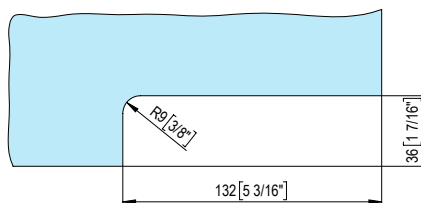

1510R



1520

1520R = destra - derecha - right - rechts - droite
 1520L = sinistra - izquierda - left - links - gauche

 10mm 3/8"	 12mm 1/2"
 900 mm 35 7/16"	 55Kg 121 lbs

Da specificare all'ordine
 Please specify in detail
 when ordering

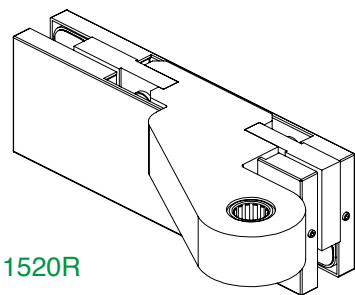

- Cerniera superiore con perno spostato(DX-SX).
- Pernio superior con eje desplazado (DCH. - IZQ.).
- Top offset pivot patch. (right - left).
- Oberes Band mit seitlich angeschlagenem Zapfen. (rechts - links).
- Penture haute à axe déporté (DR-G).

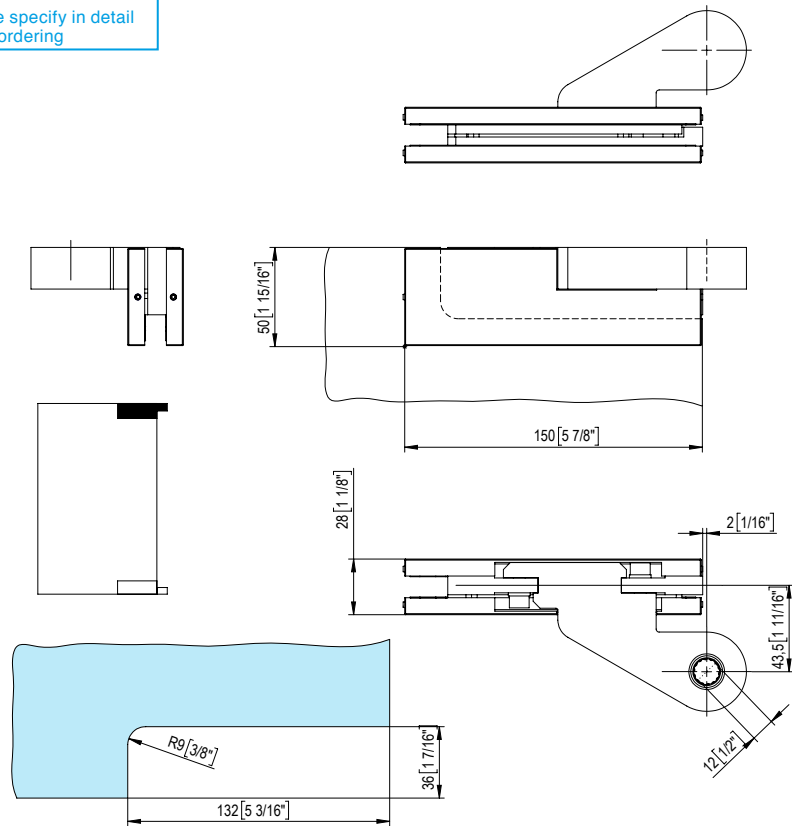

1520R



1522

 10-12mm 3/8" - 1/2"	 900 mm 35 7/16"
 55Kg 121 lbs	

- Cerniera superiore con perno spostato.
- Pernio superior con eje desplazado.
- Top offset pivot patch.
- Oberes Band mit seitlich angeschlagenem Zapfen.
- Charnière supérieure à axe déporté (DR-G)

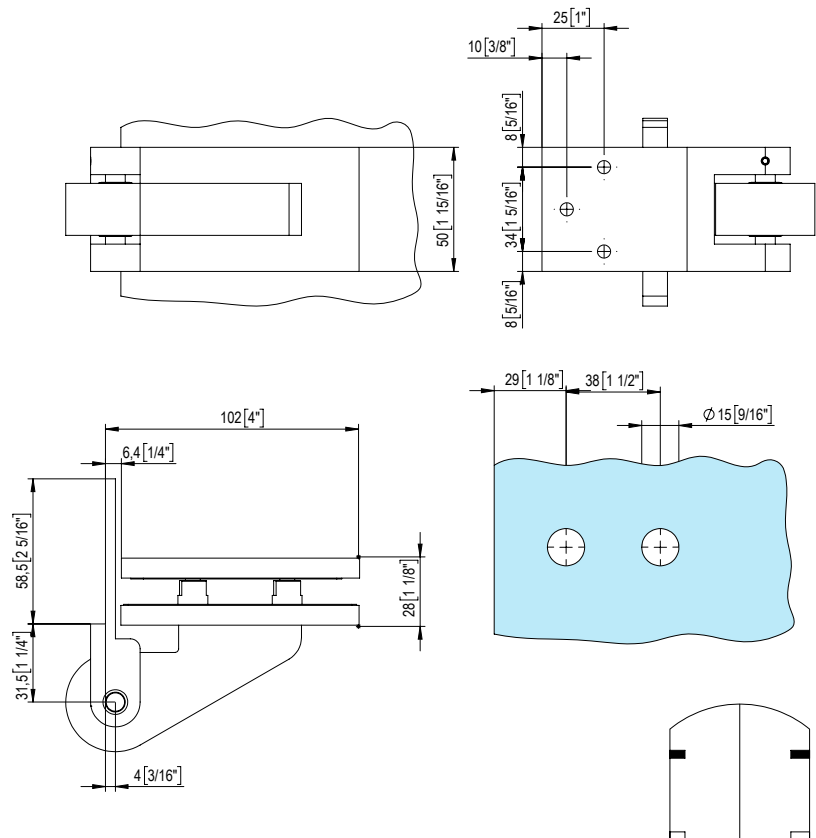
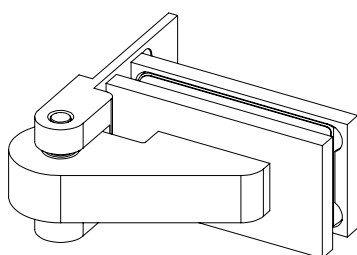

1527

1527R = destra - derecha - right - rechts - droite
 1527L = sinistra - izquierda - left - links - gauche

- Piletta superiore con perno spostato. Per art. 1520(DX-SX).
- Punto de giro superior con eje desplazado para 1520 (DCH. - IZQ.).
- Top offset pin for 1520. (right - left).
- Oberer Zapfen mit seitlich angeschlagenem Stift für 1520. (rechts - links).
- Broche supérieure à axe déporté pour l'art. 1520(DR-G).

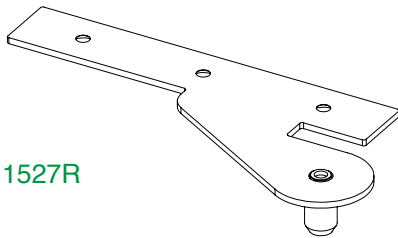

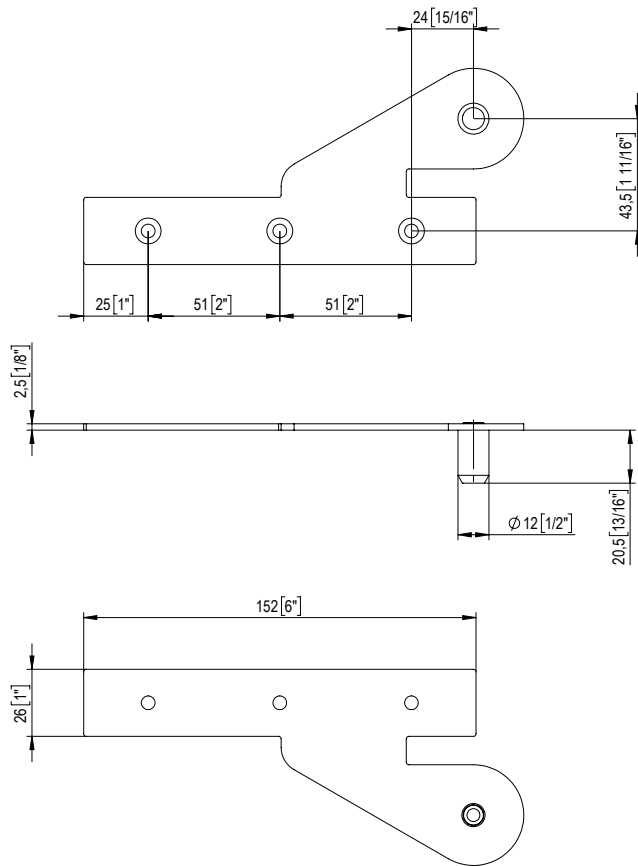

1527R



1518

1518R = destra - derecha - right - rechts - droite
 1518L = sinistra - izquierda - left - links - gauche

 10-12mm 3/8" - 1/2"	 900 mm 35 7/16"
 MAX 55Kg 121 lbs	

- Cerniera inferiore con perno spostato. (DX-SX) in battuta.
- Pernio inferior con eje desplazado (DCH. - IZQ.). Con tope.
- Bottom offset pivot patch. (right - left). With stop.
- Unteres Band mit seitlich angeschlagenem Stift (rechts - links). Mit Anschlag.
- Penture basse à axe déporté (DR-G). A butée.

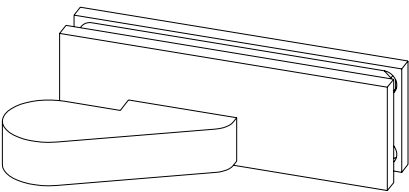

1518L

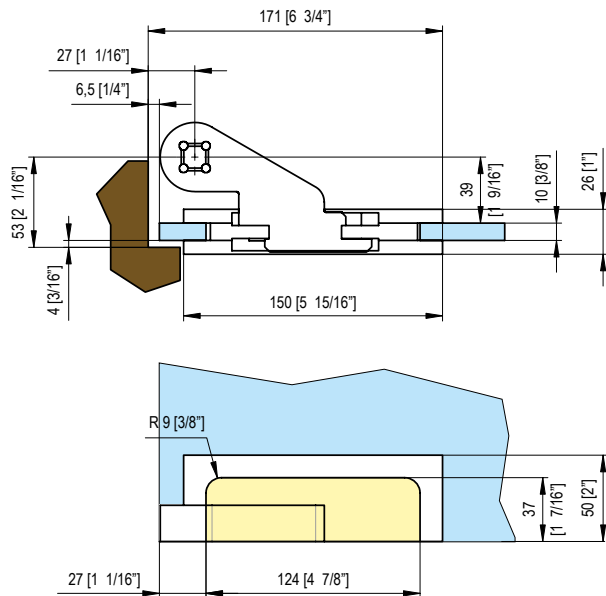

1528

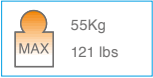

- Cerniera superiore con perno spostato. In battuta.
- Pernio superior con eje desplazado. Con tope.
- Top offset pivot patch. With stop.
- Oberes Band mit seitlich angeschlagenem Stift. Mit Anschlag.
- Charnière supérieure à axe déporté. A butée.

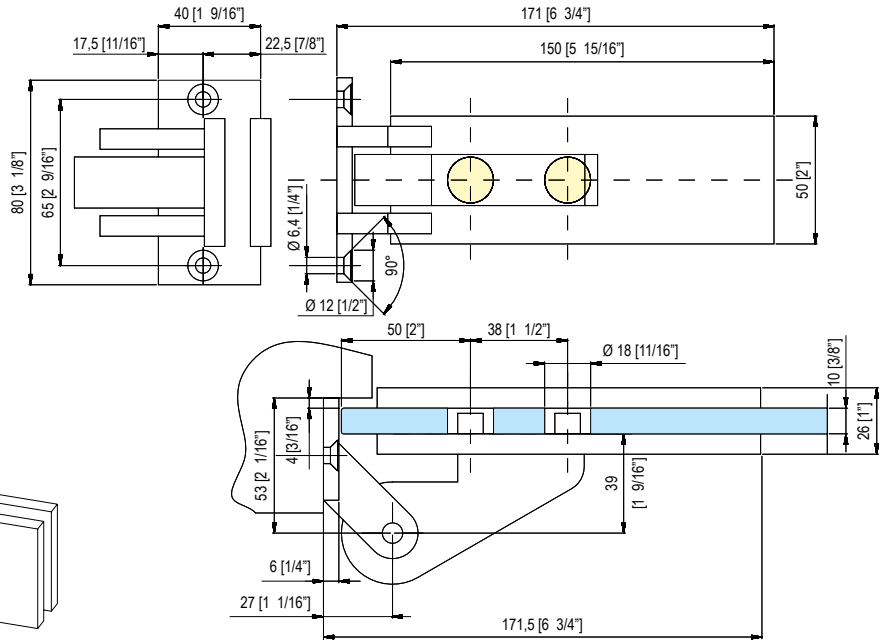
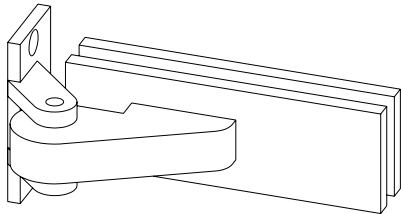

1810

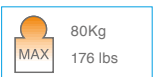

- Cerniera inferiore a perno centrale.
- Pernio inferior central. Cuadro italiano.
- Bottom hinge with central pivot.
- Unteres Scharnier mit Zentralstift.
- Penture basse à axe central. Carré italien.

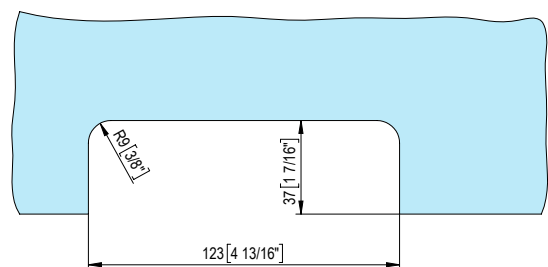
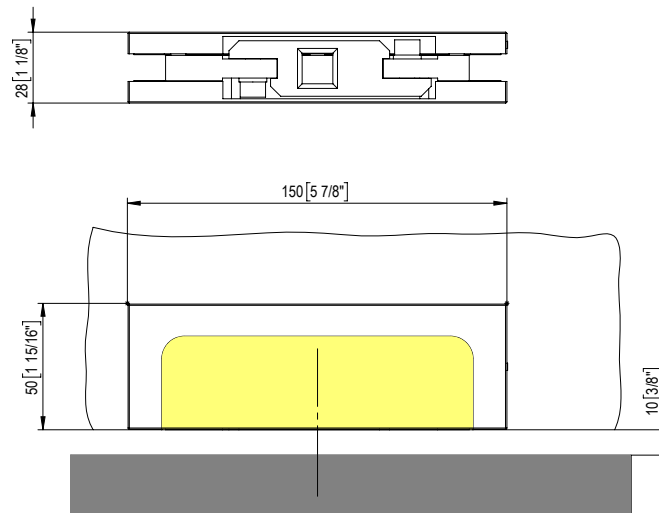
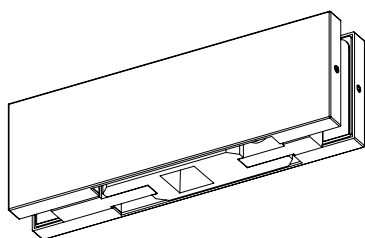

1820

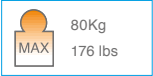
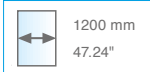

- Cerniera superiore a perno centrale con cuscinetto registrabile.
- Pernio superior central. Cuadro italiano.
- Top hinge with central pivot with adjustable bearing.
- Oberes Scharnier mit Zentralstift mit verstellbarem Lager.
- Penture haute à axe central avec roulement réglable. Plaque italienne.

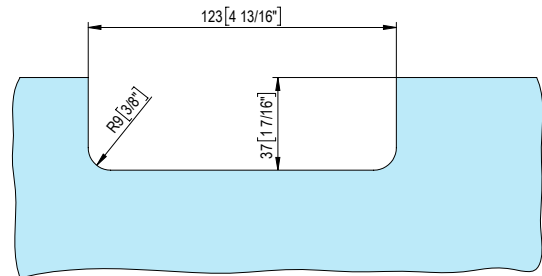
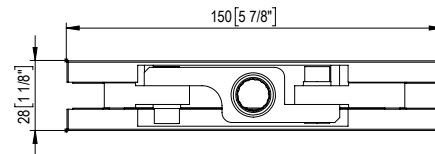
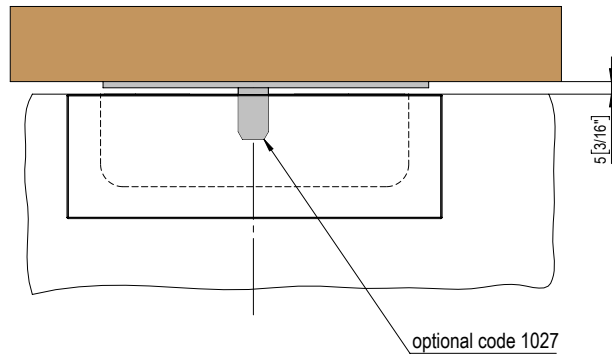
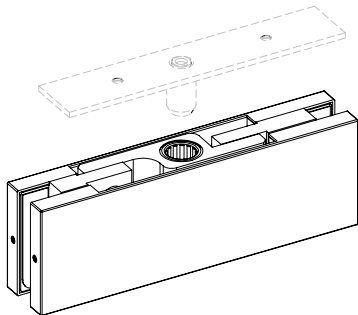

1825



- Attacco al sopraluce per art. 1820.
- Enganche de giro montante para art.1820.
- Transom link fitting for 1820.
- Kupplung für Oberlichtfenster für 1820.
- Fixation sous imposte pour l'art. 1820.

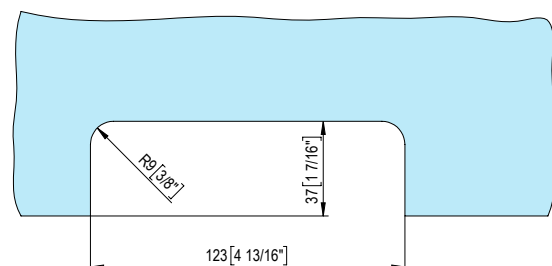
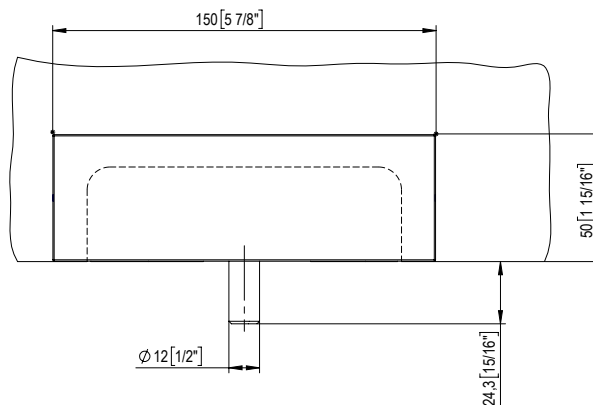
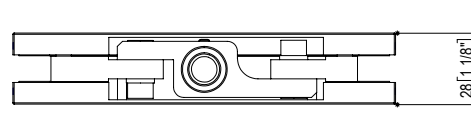
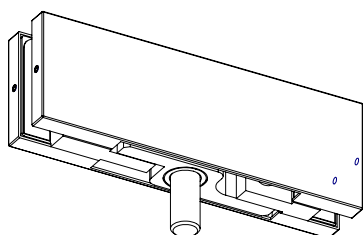

A20



- Fermaporta centrale al sopraluce con lunette. Permette apertura a 180°.
- Fija puerta central a la luna, con lunetas. Permite abertura a 180°.
- Centre doorstop to the upper segment with steady It allows 180° opening.
- Zentraler Türhalter fest am Oberlichtfenster mit Setzstock . Es erlaubt Öffnung zu 180°.
- Double butée modulable sur imposte. Ouverture jusqu'à 180°.

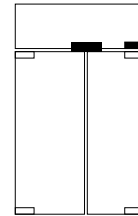
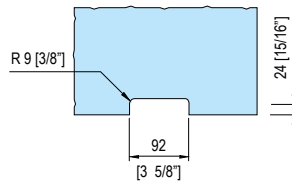
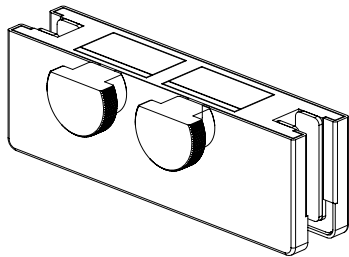
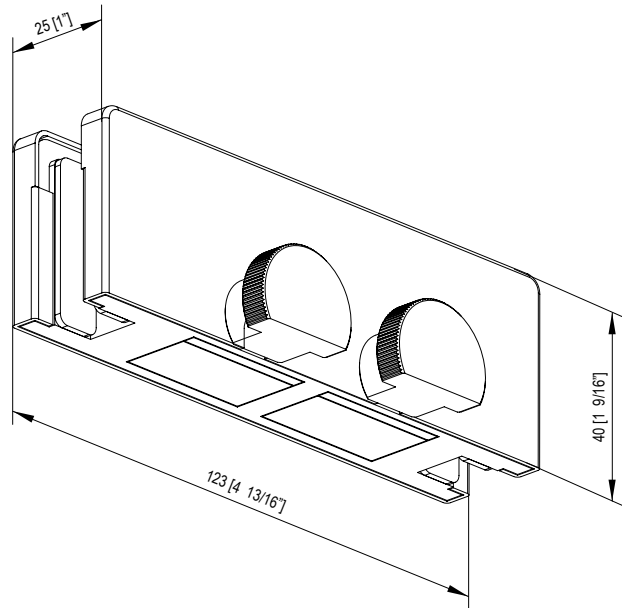

<p>1X10/13 (13,52mm) 1X10/17 (17,52mm)</p>	<p>1X20/13 (13,52mm) 1X20/17 (17,52mm)</p>	<p>1000 mm 39.37" *</p> <p>100Kg 220 lbs MAX</p>	
<p>1X40/13 (13,52mm) 1X40/17 (17,52mm)</p>	<p>1X40/13 (13,52mm) 1X40/17 (17,52mm)</p>	<p>1000 mm 39.37" *</p> <p>100Kg 220 lbs MAX</p>	
<p>1X30/13 (13,52mm) 1X30/17 (17,52mm)</p>	<p>1X30/13 (13,52mm) 1X30/17 (17,52mm)</p>	<p>1000 mm 39.37" *</p> <p>100Kg 220 lbs MAX</p>	
<p>1X81/13 (13,52mm) 1X81/17 (17,52mm)</p>	<p>1X82/13 (13,52mm) 1X82/17 (17,52mm)</p>	<p>1000 mm 39.37" *</p> <p>120Kg 264 lbs MAX</p>	
<p>6X30/13 (13,52mm) 6X30/17 (17,52mm)</p>	<p>6X30/13 (13,52mm) 6X30/17 (17,52mm)</p>	<p>1000 mm 39.37" *</p> <p>120Kg 264 lbs MAX</p>	<p>1X27</p> <p>1X28</p> <p>1X73</p>

* Per dimensioni e pesi superiori contattare il nostro ufficio tecnico - Para mayores dimensiones y pesos, póngase en contacto con nuestra oficina técnica - For bigger dimensions and higher weights please get through to our technical department - Für größere Maßen und stärkeres Gewicht setzen sie sich bitte mit unserem technischen Büro in Kontakt - Pour les dimensions et poids plus élevés, veuillez contacter notre service technique

CHD1

- Chiudiporta Dorma cod. BTS75V.
- Cierra puerta Dorma cod. BTS75V.
- Dorma floor spring code BTS75V.
- Türschließer Dorma BTS75V.
- Frein de sol réf. BTS75V. Finitions 31-32.

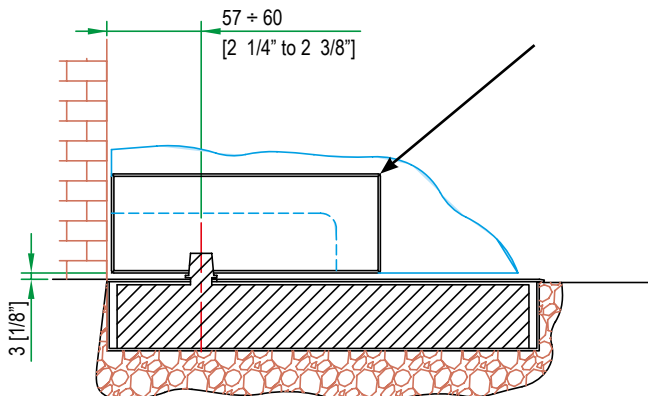
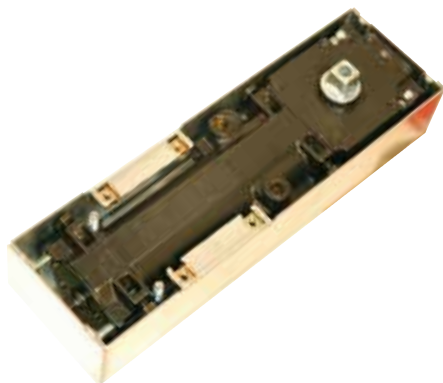

LEGENDA CODICE - CODE LEGEND

Codice-code	Apertura-opening	Forza-force	Quadro-Pivot Housing	Finitura-finishing
C H D 1	9 0 90°	F R Regolabile Adjustable	Q I Italiano Italian	3 1 Inox satinato Satin stainless steel
	0 5 105°		Q T Tedesco German	3 2 Inox lucido Bright stainless steel
	0 0 libero free		Q E Spagnolo Spanish	

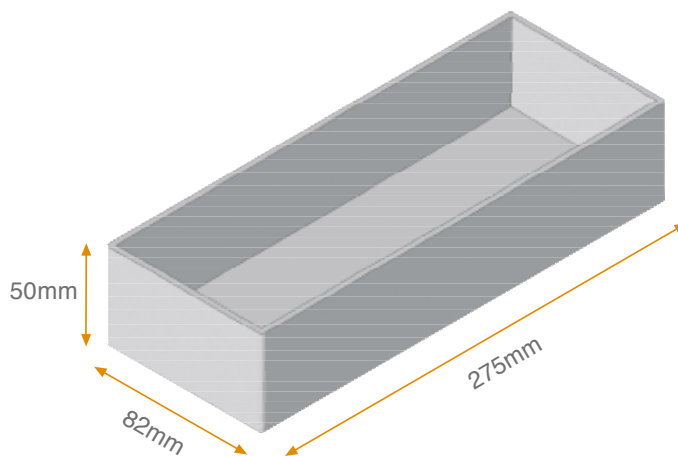
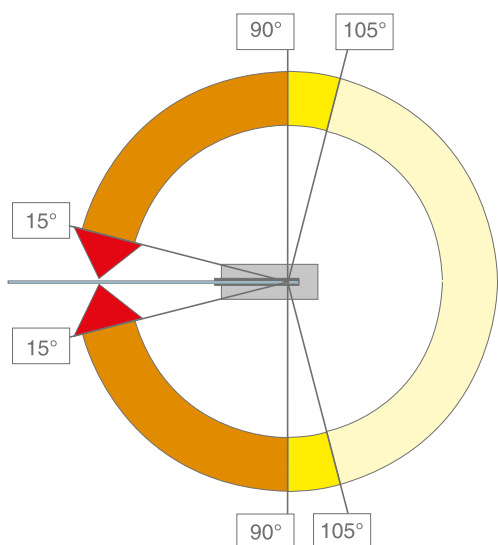

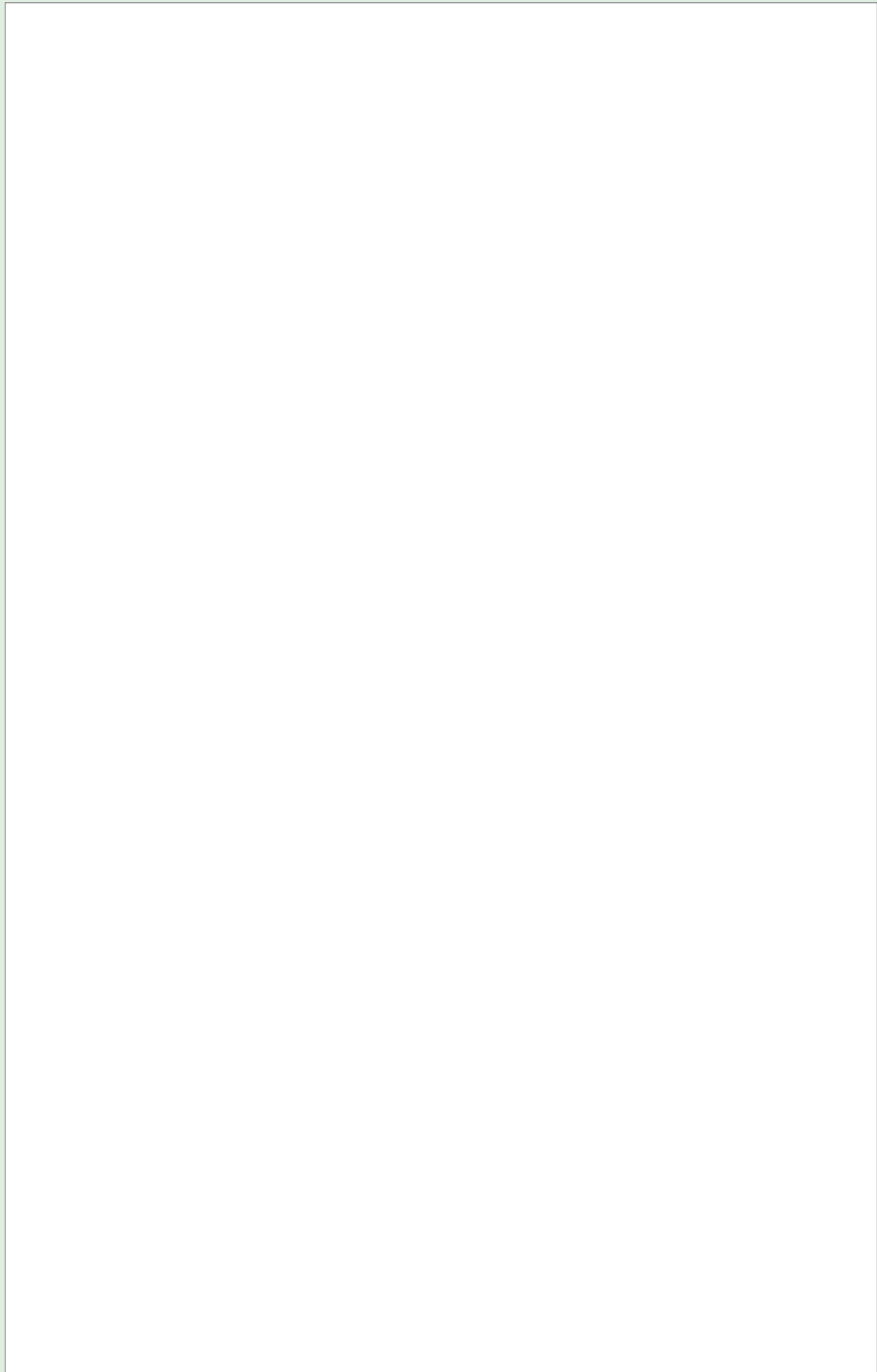



SERRATURE e MANIGLIONI

Cerraduras y Tiradores
Locks and Handles
Schlüssel und Türstoßgriffe
Serrures et Poignées

serrature / locks

Flexa



chiave / key



pomolo / knob



libero-occupato / free/occupied

Alluminio / Aluminium - finiture / colors 02-05-13-14-15-16-17-60-62

Concetto di serratura progettato partendo dalle più esigenti richieste di mercato. Volevamo realizzare una serratura di dimensioni ridotte, dal minimalismo estetico e soprattutto funzionale. La vera innovazione sta nel meccanismo interno "brevettato" che permette a Flexa di essere ambidestra, silenziosa e robusta.

Tre le versioni disponibili: chiave-chiave, chiave-pomolo, pomolo-libero/occupato. Colcom propone inoltre cerniera (art.8810) e controserratura in coordinato.

Concepto de cerradura proyectado por petición del mercado. Hemos pensado sobre el problema de las dimensiones reducidas, de minimalismo estético y lineal. La novedad se encuentra en el mecanismo interior, con despacho, que permite a Flexa de ser ambidextra, silenciosa y recia.

Tres variantes: llave-llave, llave-pomo, pomo-ocupado/libre. Colcom presenta también bisagra (art.8810) y cerradero coordinadas.

Concept of lock designed starting from the most demanding requests of the market. We wished to realize a lock of reduced dimensions, with an aesthetic and above all functional minimalism. The true innovation lies on the inner, "patented" mechanism, which allows Flexa to be ambidextrous, silent and strong. Three are the versions: key-key, key-

knob and knob-free/engaged. Colcom also proposes coordinate hinge (item.8810) and lock keeper.

Gedanke von Schloß vor, der nach den anspruchvollsten Verlangen des Marktes geplant worden ist. Wir wollten ein Schloß von verringerten Maßen, mit ästhetischem und vor allem zweckmäßigem Minimalismus realisieren. Die echte Innovation besteht aus dem inneren, „patentierten“ Mechanismus, das Flexa erlaubt, beidhändig, geräuschlos und stark zu sein.

Drei sind die verfügbaren Versionen: Schlüssel-Schlüssel, Schlüssel-Knopf und Knopf-frei/besetzt. Colcom legt auch koordiniertes Scharnier (Art 8810) und zweites Schloß vor.

Concept de serrure conçu en réponse aux demandes les plus exigeantes marché. Nous voulions faire une serrure de dimensions réduites, minimaliste, esthétique et surtout fonctionnelle. La véritable innovation réside dans le mécanisme interne "breveté" qui permet au système Flexa de fonctionner en tirant droit et tirant gauche. Trois versions disponibles: clé-clé, clé-bouton, indicateur libre/occupé. Colcom propose également une charnière (art.8810) et une gâche assorties.





6410 6411 6411A
6412 6412A

FLEXA

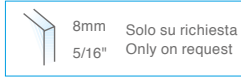

- Serratura "FLEXA" orizzontale in battuta.
- Cerradura "FLEXA" horizontal con tope.
- Horizontal lock "FLEXA" for door with stop.
- Waagerechtes Schloß "FLEXA" für Anschlagtüren.
- Serrure "FLEXA" horizontale en butée.

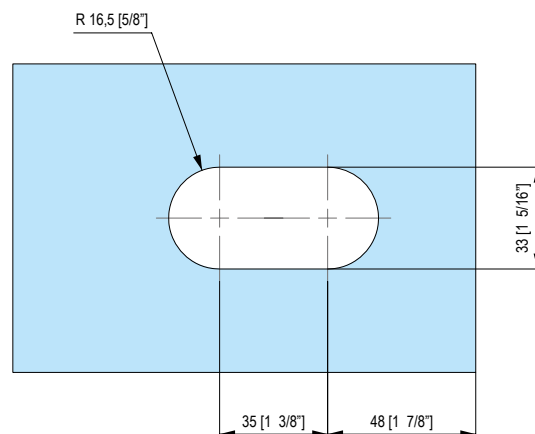
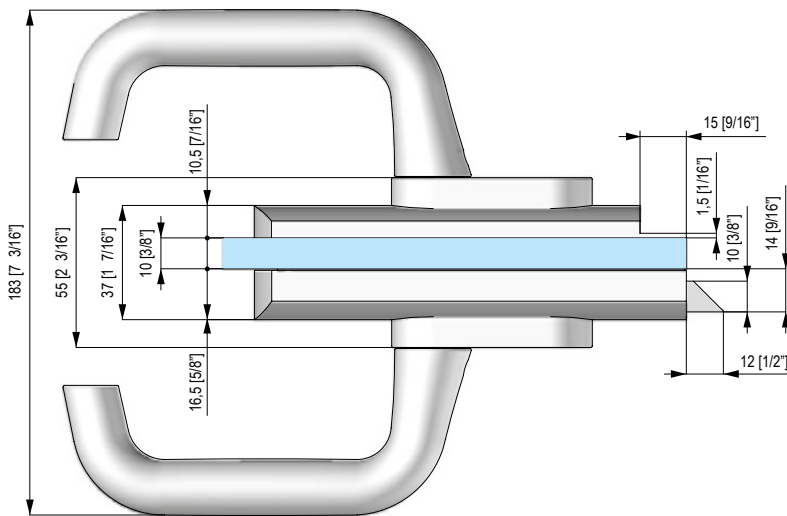
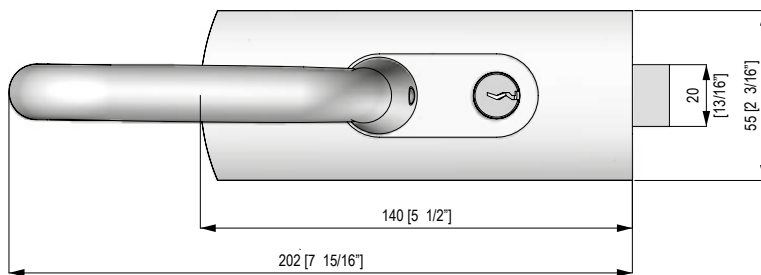

6410

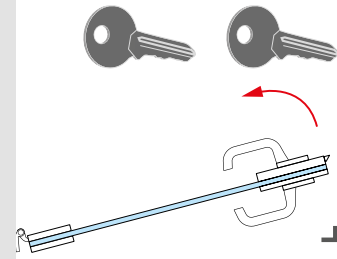

6411

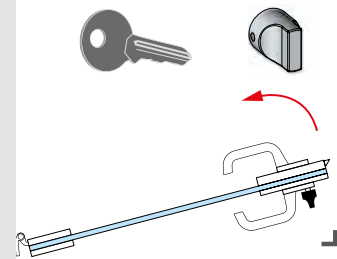

6411A

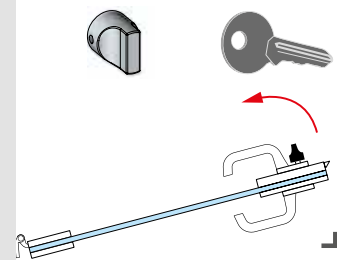

6412

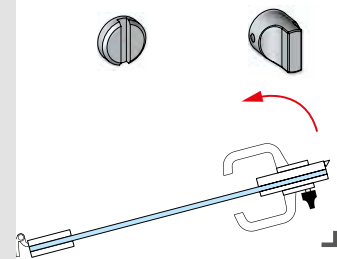

6412A

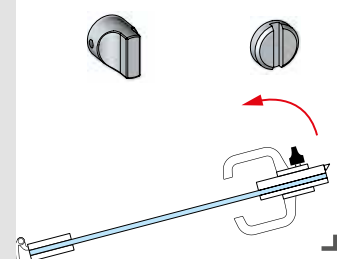

6415

FLEXA

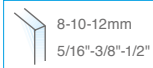

- Controserratura orizzontale "FLEXA".
- Cerradero Horizontal "FLEXA".
- Horizontal strike box "FLEXA".
- Waagrechtes Gegenschloss "FLEXA".
- Gäche horizontale "FLEXA".

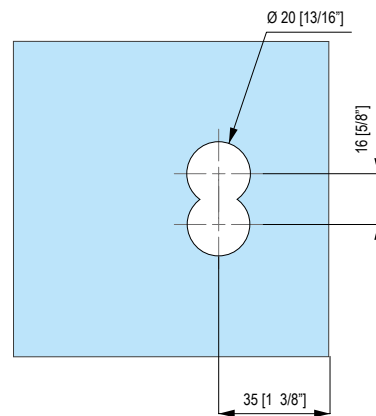
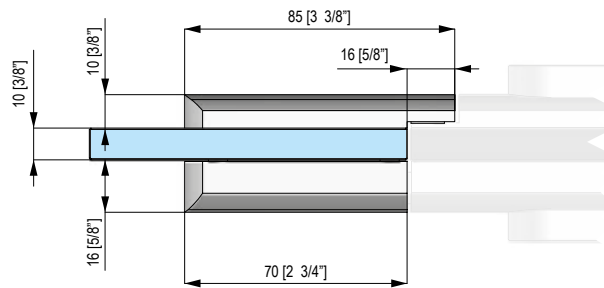
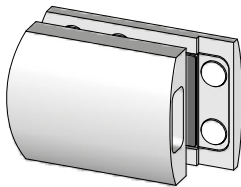
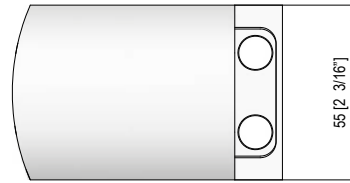

0641

- Contro piastrina.
- Contra chapa.
- Latch keep with stop.
- Gegenplatte.
- Gäche plate.

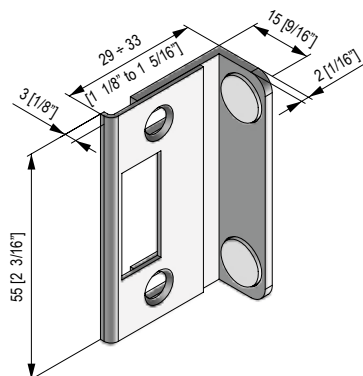

8810 (pag. 194)

FLEXA

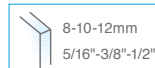

- Cerniera laterale FLEXA.
- Bisagra lateral FLEXA.
- Side hinge FLEXA.
- Seitliches Scharnier FLEXA.
- Charnière latérale FLEXA.

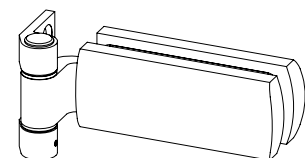

serrature / locks

Verticale



620E10



620E50



0620E10



0620E15

Alluminio / Aluminium - finiture / colors 02-05-13-14-15-16-17-60-62

Serratura con scrocco autoregolante che ha la funzione di impedire fastidiosi scuotimenti a porta chiusa. La chiave blocca lo scrocco ma lasciando libera la maniglia evitando così danni da forzature involontarie. Possibilità di montare cilindri europei quindi piena compatibilità degli standard UE.

Cerradura con sistema de cierre con la función de prevenir el molesto temblor con la puerta cerrada. La llave, bloquea el cierre pero deja libre la manilla evitando daños de forzamientos involuntarios. Posibilidad de montaje de cilindros europeos compatibles con estándar UE.

Self-positioning latch which offers a firm closure without shaking. A feature of this latch is that when locked, the handle remains free thus avoiding shaking due to accidental forcing. Accepts European cylinders to meet EU standards.

Schloss mit Selbstverriegelung um störende Vibrationen bei geschlossener Tür zu vermeiden. Der Schlüssel blockiert die Falle, (aber) der Drücker bleibt beweglich. Somit werden Beschädigungen durch eventuelle ungewünschte Krafteinwirkungen vermieden. Der Einbau von europäischen Zylindern ist möglich, es besteht absolute Kompatibilität mit dem EU-Standard.

Serrure avec loquet qui se met en place automatiquement, offrant une fermeture sans vibrations lorsque la porte se referme. La clé bloque le loquet mais laisse la poignée libre empêchant donc les dommages causés par une ouverture involontaire. Possibilité de monter des cylindres européens selon les standards UE.



PER INTERNI
INDOOR



PER ESTERNI
OUTDOOR*

*per esterno è da intendersi non a contatto diretto di acqua e con il corredo di copertine/maniglie in acciaio inox/fin 22
outdoor use is to be intended not in direct contact with water and with cover kits / handles in stainless steel / finish 22

620E10

620E10 R = destra - derecha - right - rechts - droite
 620E10 L = sinistra - izquierda - left - links - gauche

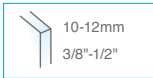

- Serratura con scrocco (autoregolante) che funge da catenaccio lasciando libera la maniglia.
- Cerradura a golpe (con autorregulación) que sirve como cerradillo, dejando libre la manija.
- Self-positioning latch with block function that leaves the handle free.
- Schloss mit Selbstverriegelung mit Blockfunktion, die der Drücker beweglich lässt.
- Serrure avec loquet (auto-régulation) qui agit comme une boucle en laissant la poignée libre.

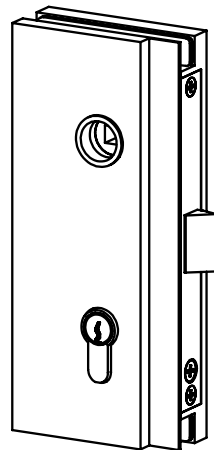
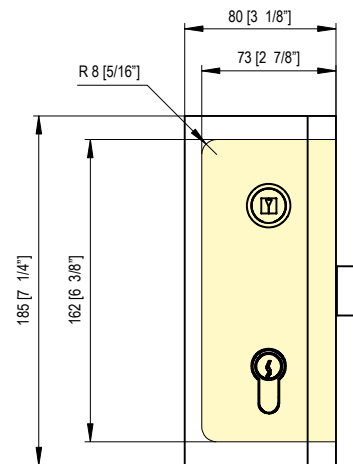
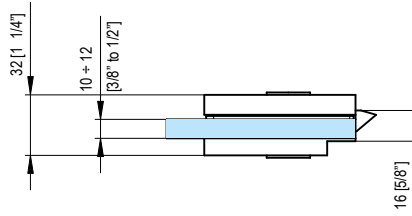

620E10R

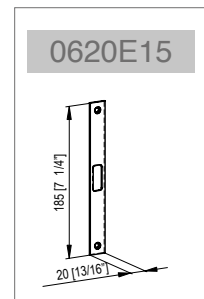
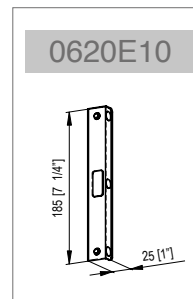

620E50

620E50 R = destra - derecha - right - rechts - droite
 620E50 L = sinistra - izquierda - left - links - gauche



- Controserratura verticale.
- Cerradero vidrio vertical.
- Vertical strike box with stop.
- Vertikales Gegenschloss.
- Gâche verticale.

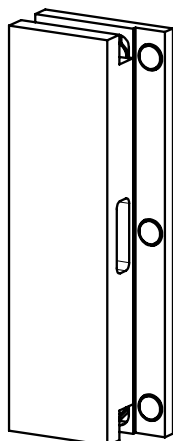
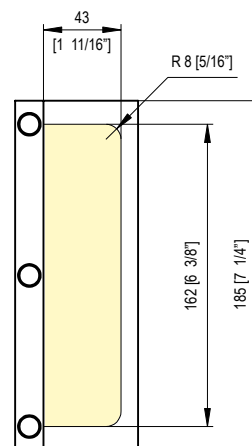

620E50R

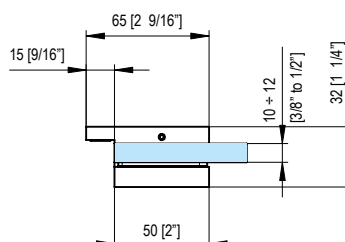

serrature / locks

Magnetica



622E10



623E10



622E50



623E50



0622E10



0622E11



0622E12

Alluminio / Aluminium - finiture / colors 02-05-13-14-15-16-17-60-62

Serratura verticale con scrocco magnetico, disponibile per porte in battuta e porte vai e vieni. Lo scrocco è totalmente a scomparsa garantendo massima sicurezza. Estremamente silenziosa e versatile può essere installata in uffici o abitazioni. Realizzata in alluminio nelle consuete finiture Colcom

Cerradura vertical con estafa magnética, adapta tanto para puertas con batita como para puertas a acción doble. La estafa es completamente escamoteable y garantiza máxima seguridad Muy silenciosa y versatil, puede ser instalada tanto en oficinas como en casas privadas. Hecha de aluminio y disponible en los acabados Colcom usuales.

Vertical lock with magnetic latch, suitable both for jamb doors or double swing doors. The latch is completely storable, still maintaining the maximum security. Being extremely silent and versatile, it can be installed

either in offices or in private houses. The material is aluminum and it is available in Colcom's standard finishes

Vertikales Schloss mit magnetischem Riegel, verwendbar sowohl für Türen mit Rahmen als auch zweiflügeligen Türen. Der Riegel ist komplett lagerfähig, bietet aber dennoch die volle Sicherheit. Das Schloss ist leise und vielseitig und kann daher im Privat- und Objektbereich verwendet werden. Das Basismaterial ist Aluminium und ist in den Standardoberflächen von Colcom verfügbar.

Serrure verticale à loquet magnétique pour portes à battement et pour portes va-et-vient. Le loquet est complètement escamotable, ce qui assure un maximum de sécurité. Extrêmement silencieuse et versatile, elle s'intègre parfaitement dans les bureaux ou dans les bâtiments résidentiels. Réalisée en aluminium dans les finitions Colcom habituelles.



PER INTERNI
INDOOR



PER ESTERNI
OUTDOOR*

*per esterno è da intendersi non a contatto diretto di acqua e con il corredo di copertine/maniglie in acciaio inox/fin 22
outdoor use is to be intended not in direct contact with water and with cover kits / handles in stainless steel / finish 22



622E10

622E10 R = destra - derecha - right - rechts - droite
 622E10 L = sinistra - izquierda - left - links - gauche

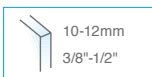

• Serratura verticale con scrocco magnetico chiave-chiave in battuta.

• Cerradura vertical llave-llave con estafa magnética para puertas con batida.

• Vertical lock key-key with magnetic latch for jamb doors.

• Vertikal Schloss Schlüssel- Schlüssel mit magnetischem Riegel für Türen mit Rahme.

• Serrure verticale à clé avec verrouillage magnétique pour portes à butée.

**Abbinabile con
Matchable with**

622E50
 0622E10
 0622E11
 0622E12

622E10R

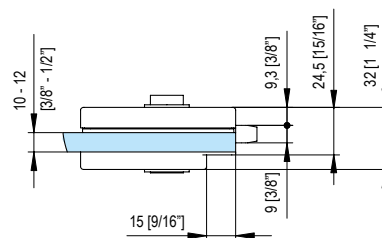
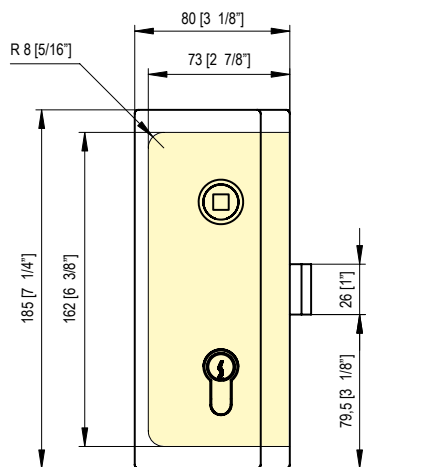
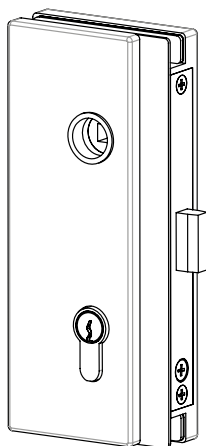

623E10



• Serratura verticale con scrocco magnetico chiave-chiave. Doppio senso di apertura.

• Cerradura vertical llave-llave con estafa magnética para puertas a acción doble.

• Vertical lock key-key with magnetic latch for double swing doors.

• Vertikal Schloss Schlüssel- Schlüssel mit magnetischem Riegel für zweifügelige Türen.

• Serure verticale clé-clé avec verrouillage magnétique pour portes doubles.

**Abbinabile con
Matchable with**

623E50
 0622E11
 0622E12

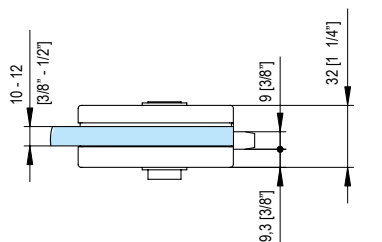
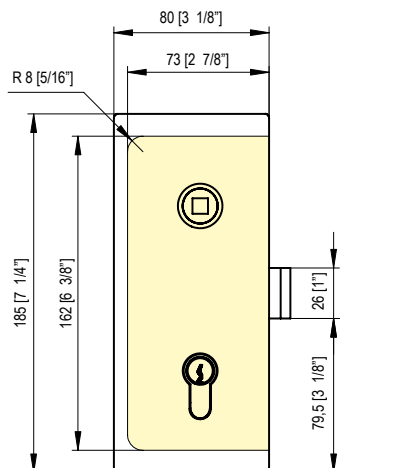
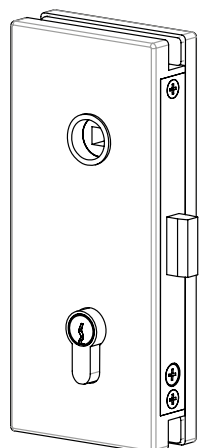

622E50

622E50 R = destra - derecha - right - rechts - droite

622E50 L = sinistra - izquierda - left - links - gauche



- Controserratura magnetica verticale in battuta.
- Cerradero magnético vertical para puertas con batida.
- Magneti c vertical lock keeper for jamb doors.
- Magnetisches Vertikalgegenschloss für Türen mit Rahmen.
- Gâche sur verre magnétique avec butée.

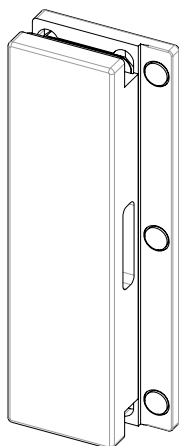

622E50R

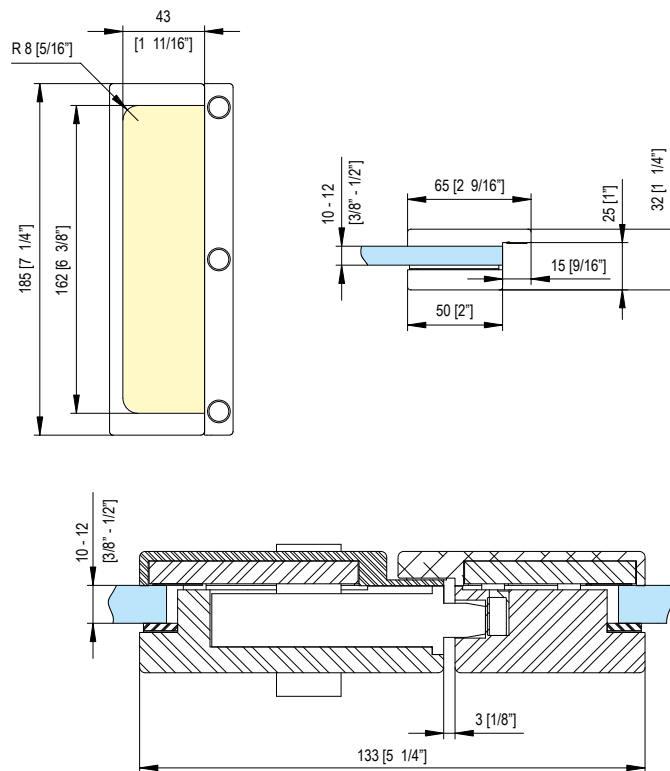

623E50



- Controserratura magnetica verticale doppio senso di apertura.
- Cerradero magnético vertical para puertas a acción doble.
- Magneti c vertical lock keeper for double swing doors.
- Magnetisches Vertikalgegenschloss für zweifügelige Türen.
- Gâche sur verre 2 sens d'ouverture.

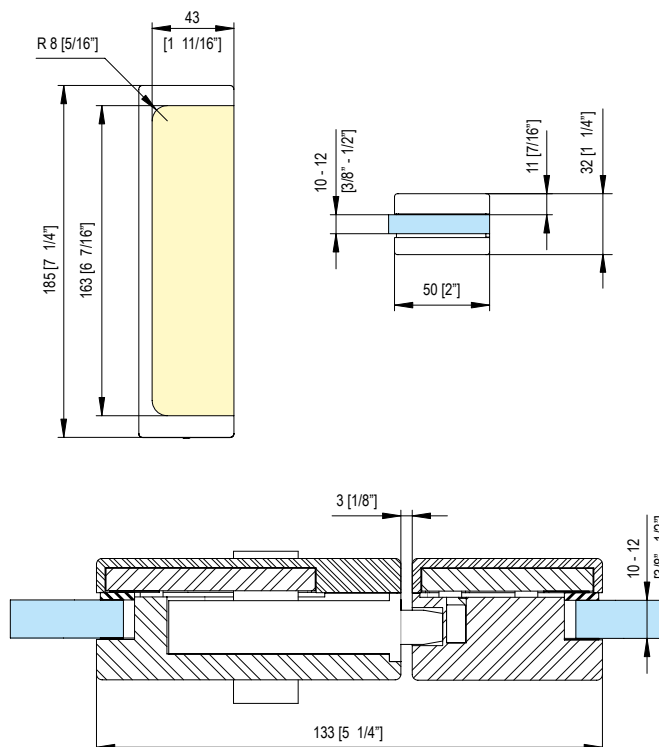
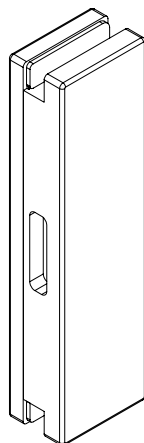

0622E10

- Riscontro magnetico in battuta per art. 622E10.
- Contra chapa magnética con batida para art. 622E10.
- Magnetic latch keeper with jamb for art. 622E10.
- Magnetische Gegenplatte mit Rahmen für art. 622E10.
- Gâche magnétique sur mur pour art 622E10.

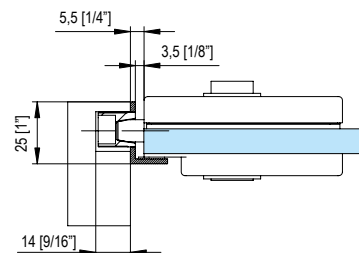
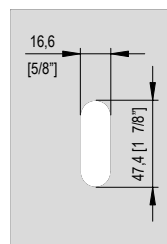
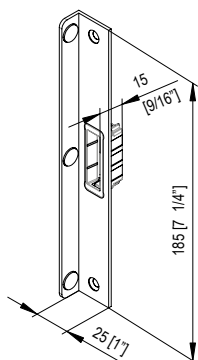

0622E11

- Riscontro magnetico a muro per art.622E10 e 623E10.
- Contra chapa magnética a muro para art. 622E10 y 623E10.
- Wall magnetic latch keeper for art 622E10 and 623E10.
- Wand magnetische Gegenplatte für art. 622E10 und 623E10.
- Gâche magnétique sur mur pour art 622E10.

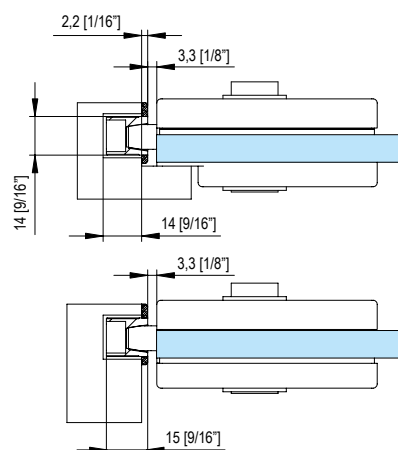
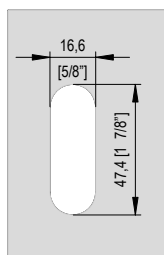
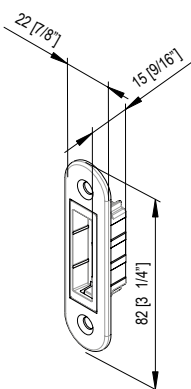

0622E12

- Riscontro magnetico stipiti in alluminio per art.622E10 e 623E10.
- Contra chapa magnética para jambas de aluminio para art. 622E10 y 623E10.
- Magnetic latch keeper for aluminum frames for art. 622E10 and 623E10.
- Magnetische Gegenplatte für Aluminiumpfosten für art. 622E10 und 623E10.
- Gâche magnétique en aluminium pour art 622E10.

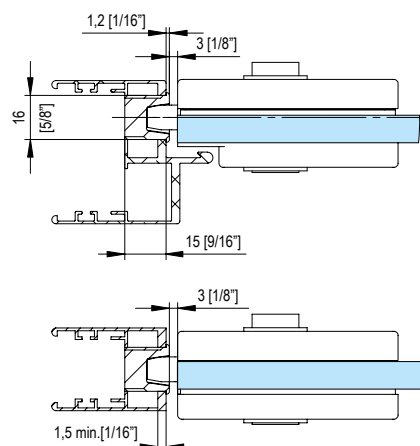
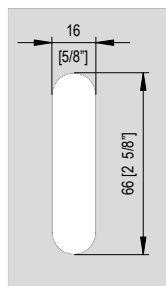
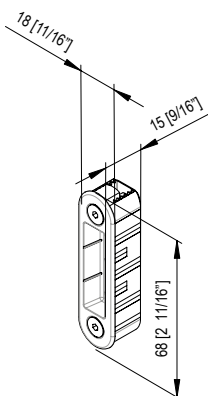

serrature / locks

<p>Alluminio / Aluminium</p>  <p>6641 finiture / colors 02-05 13-14-15-16-17-60-62</p>	<p>Alluminio / Aluminium</p>  <p>6840 finiture / colors 02-05 14-15-16-17-31-60-62</p>	<p>Alluminio / Aluminium</p>  <p>6845 finiture / colors 02-05 14-15-16-17-31-60-62</p>	<p>Alluminio / Aluminium</p>  <p>6623 finiture / colors 15</p>	<p>Alluminio / Aluminium</p>  <p>6628 finiture / colors 15</p>
<p>Alluminio / Aluminium</p>  <p>6730 finiture / colors 02-05-13-14-15</p>	<p>Alluminio / Aluminium</p>  <p>6734 finiture / colors 02-05-13-14-15</p>	<p>Alluminio / Aluminium</p>  <p>6731 finiture / colors 02-05-13-14-15</p>	<p>Alluminio / Aluminium</p>  <p>6735 finiture / colors 02-05-13-14-15</p>	<p>Alluminio / Aluminium</p>  <p>6736 finiture / colors 02-05</p>
<p>Alluminio / Aluminium</p>  <p>6640 finiture / colors 02-05-14-15-16-17</p>	<p>Alluminio / Aluminium</p>  <p>6650 finiture / colors 02-05-14-15-16-17</p>	<p>Ottone / Brass</p>  <p>6630 finiture / colors 02-05 14-15-16-17-31-60-62</p>	<p>Ottone / Brass</p>  <p>6830 finiture / colors 02-05 14-15-16-17-31-60-62</p>	<p>Alluminio / Aluminium</p>  <p>6835 finiture / colors 02-05 14-15-16-17-31-60-62</p>
<p>Alluminio / Aluminium</p>  <p>6640 finiture / colors 02-05 14-15-16-17-31-60-62</p>	<p>Alluminio / Aluminium</p>  <p>6645 finiture / colors 02-05 14-15-16-17-31-60-62</p>	<p>Alluminio / Aluminium</p>  <p>6870 finiture / colors 02-05-13-14-15-16-17</p>	<p>Alluminio / Aluminium</p>  <p>6875 finiture / colors 02-05-14-15-16-17-31</p>	<p>Alluminio / Aluminium</p>  <p>6650N finiture / colors 02-05 13-14-15-16-17-60-62</p>
<p>Alluminio / Aluminium</p>  <p>6855N finiture / colors 02-05 13-14-15-16-17-60-62</p>	<p>Alluminio / Aluminium</p>  <p>6652N finiture / colors 02-05 13-14-15-16-17-60-62</p>	<p>Alluminio / Aluminium</p>  <p>6852N finiture / colors 02-05 13-14-15-16-17-60-62</p>	<p>Alluminio / Aluminium</p>  <p>1030 finiture / colors 02-05 14-15-16-17-31-60-62</p>	<p>Alluminio / Aluminium</p>  <p>100E30 fin / col. 02-05-14 15-16-17-31-32-60-62</p>



6641

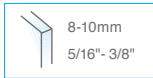

- Serratura con scrocco con foro per maniglia.
- Cerradura de pestillo con cuadro para manilla.
- Lock with latch bolt and hole for handle seating.
- Schloss mit Riegel und Loch für Türdrücker.
- Serrure avec loquet de verrou et trou pour la poignée.

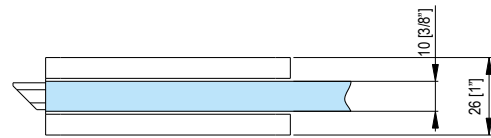
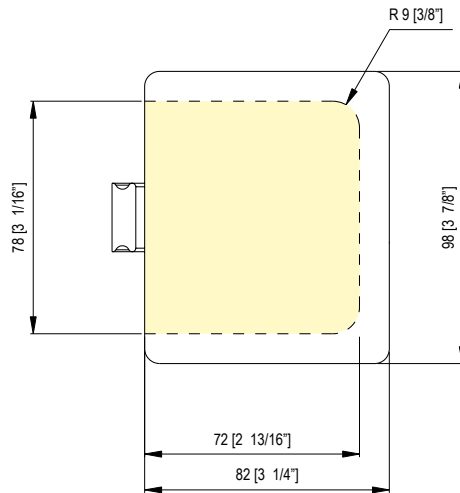
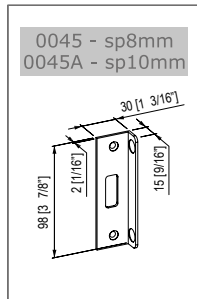
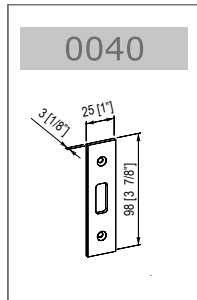
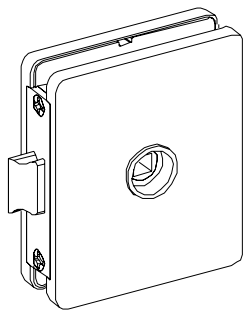

6840

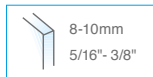

- Controserratura per art.6640-6641-6645.
- Cerradero vidrio sin tope para art. 6640-6641-6645.
- Strike box for 6640-6641-6645.
- Gegenschloss für 6640-6641-6645.
- Gâche pour art.6640-6641-6645.

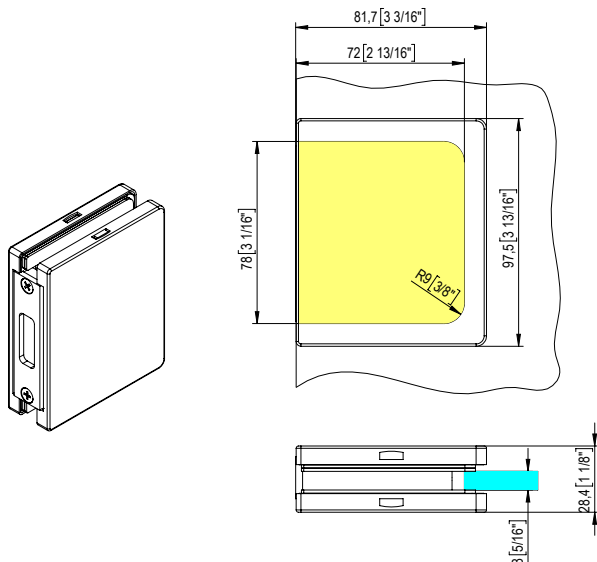

6845

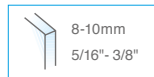

- Controserratura con battuta per art. 6640-6641-6645.
- Cerradero vidrio con tope para art. 6640-6641-6645.
- Strike box with stop for 6640-6641-6645.
- Gegenschloss mit Anschlag für 6640-6641-6645.
- Gâche en butée pour art. 6640-6641-6645.

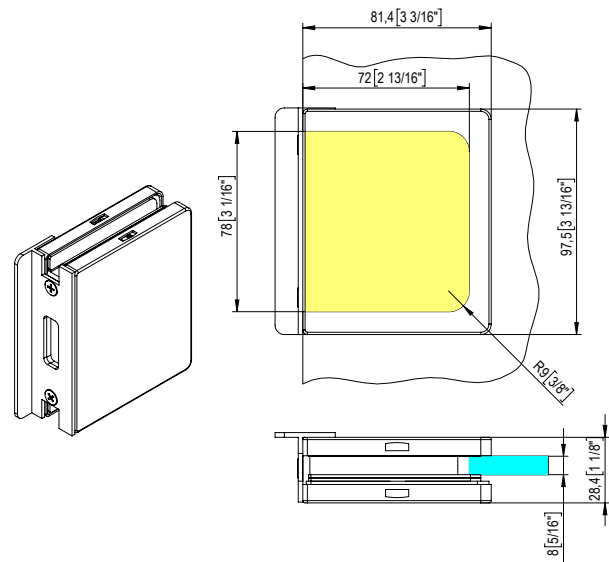

6623

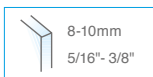

- Serratura "Meroni FORMA".
- Cerradura "Meroni Forma".
- Lock "Meroni Forma".
- Schloss "Meroni Forma".
- Serrure "Meroni FORMA".

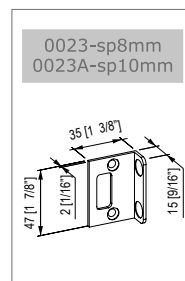
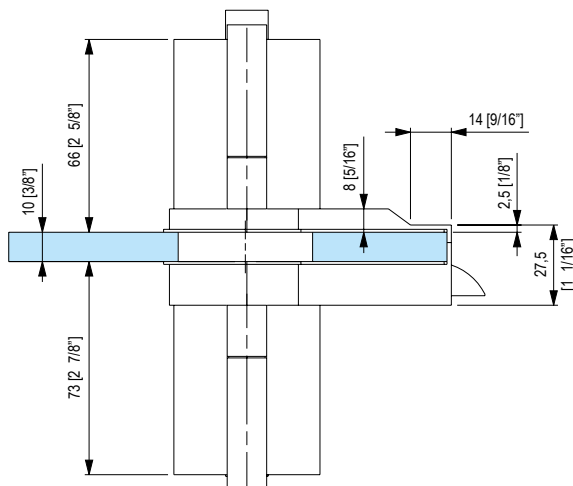
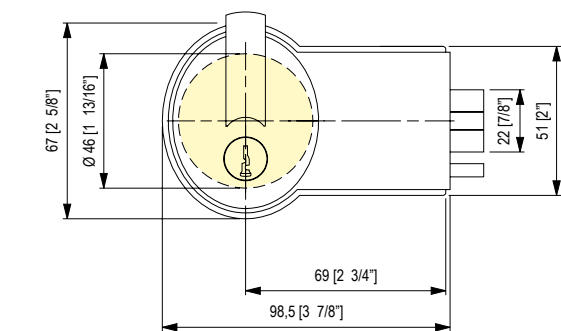
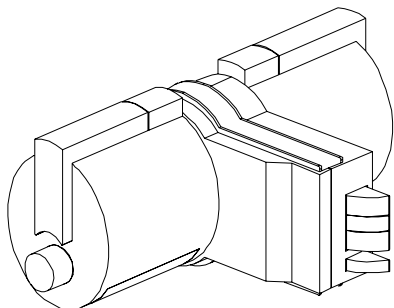

6628

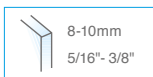

- Controserratura per "Meroni Forma".
- Cerradero "Meroni Forma".
- Strike box "Meroni Forma".
- Gegenschloss "Meroni Forma".
- Gâche pour "Meroni Forma".

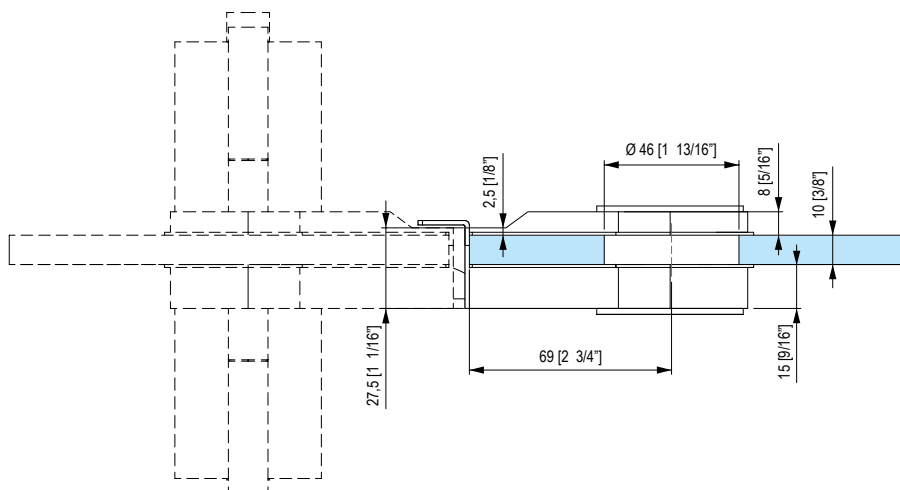
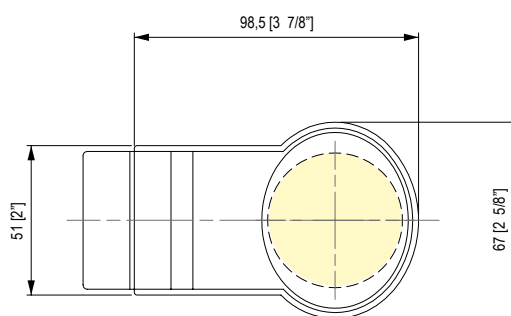
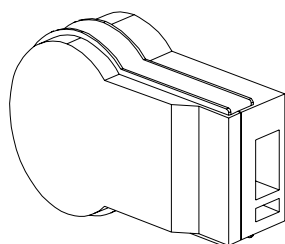

Hoppe HCS

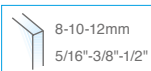

- Sistema Hoppe HCS.
- Sistema Hoppe HCS.
- Hoppe HCS system.
- System Hoppe HCS.
- Système Hoppe HCS.

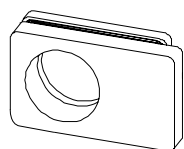
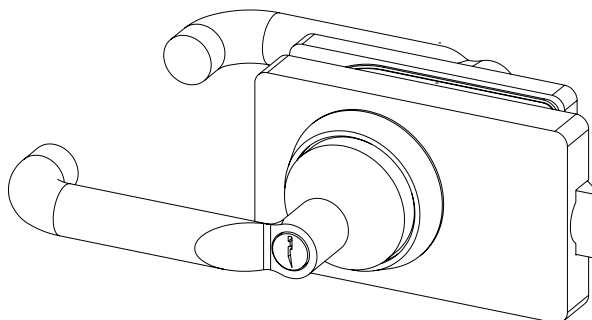

6730

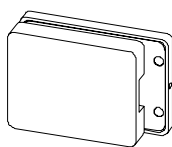

6734

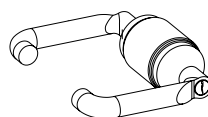

6736/6736A



6H01/02



6H03/04



6H05/06



6H07

Hoppe HCS

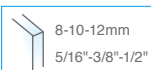

- Sistema Hoppe HCS.
- Sistema Hoppe HCS.
- Hoppe HCS system.
- System Hoppe HCS.
- Système Hoppe HCS.

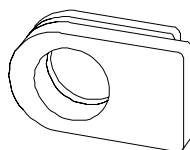
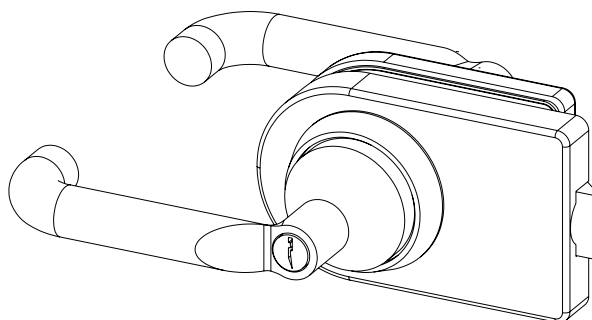

6731

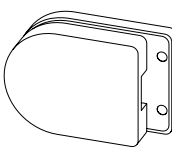

6735

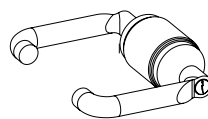

6736/6736A



6H01/02



6H03/04



6H05/06



6H07

6730

- Adattatore orizzontale per maniglie Hoppe Hcs.
- Adaptador horizontal para manilla Hoppe Hcs.
- Horizontal adapter for Hoppe Hcs handles.
- Waagerechter Adapter für Drücker Hoppe Hcs.
- Adaptateur horizontal pour poignée Hoppe Hcs.

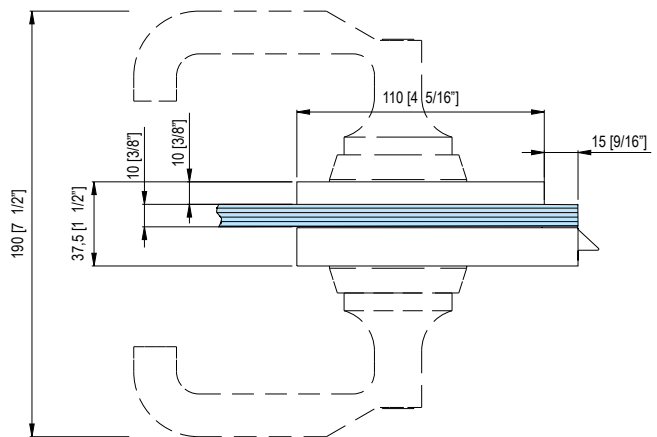
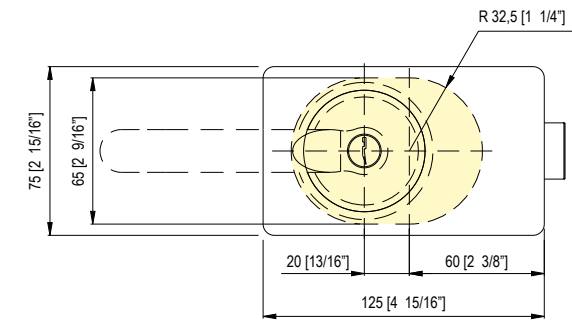
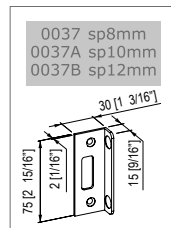
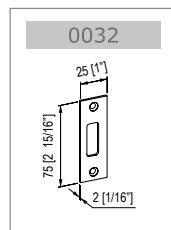
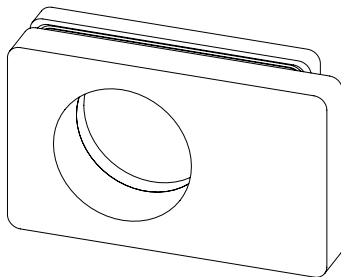

6734

- Controserratura orizzontale per adattatore maniglia Hoppe Hcs.
- Cerradero horizontal con adaptador manilla Hoppe Hcs.
- Horizontal strike box for Hoppe HCS handle adapter.
- Waagerechtes Gegenschloss für Drückeradapter Hoppe HCS.
- Gâche horizontale pour adaptateur de poignée Hoppe Hcs.

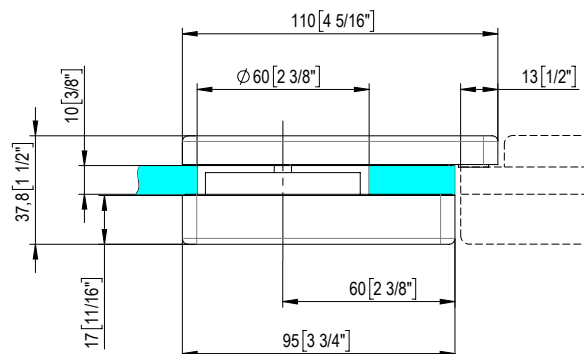
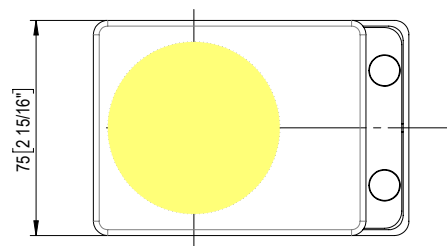
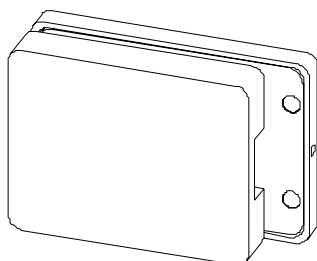

6731

- Adattatore orizzontale tondo per maniglia Hoppe Hcs.
- Adaptador horizontal redondo para manilla Hoppe Hcs.
- Horizontal rounded adapter for Hoppe Hcs handle.
- Abgerundeter, waagerechter, Adapter für Drücker Hoppe Hcs.
- Adaptateur horizontal rond pour poignée Hoppe Hcs.

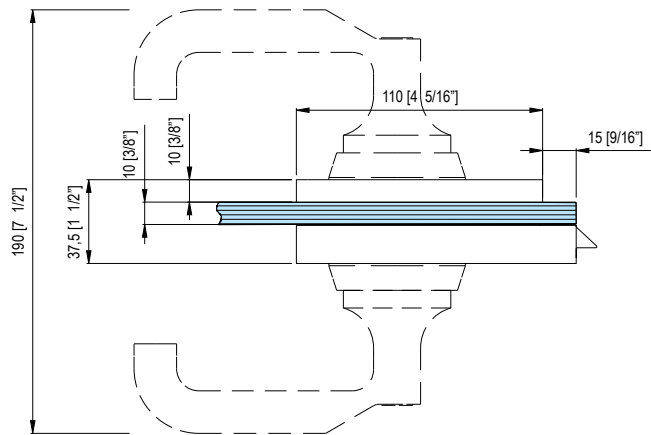
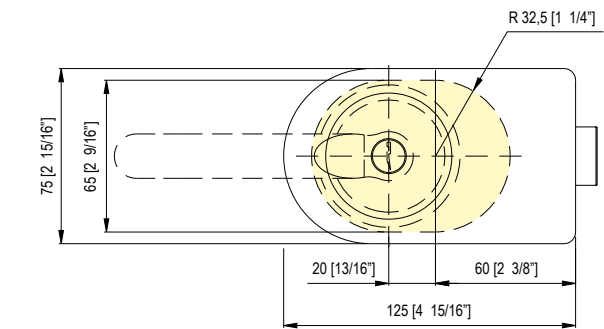
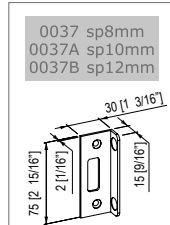
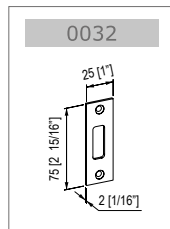
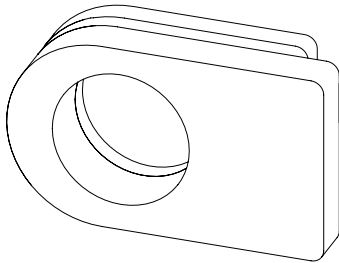

6735

- Controserratura orizzontale tonda per adattatore maniglia Hoppe Hcs.
- Cerradero horizontal redondo por adaptador manilla Hoppe Hcs.
- Horizontal round strike box for Hoppe HCS handle adapter.
- Abgerundeter, waagerechtes, Gegenschloss für Drückeradapter Hoppe Hcs.
- Gâche horizontale ronde pour adaptateur de poignée Hoppe Hcs.

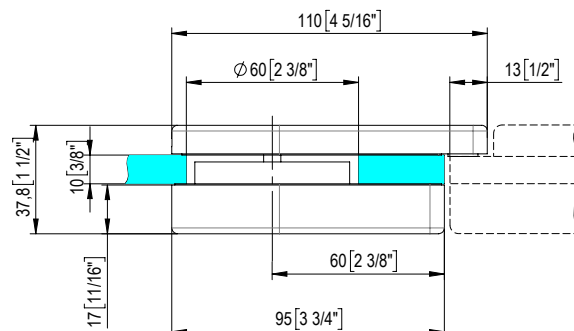
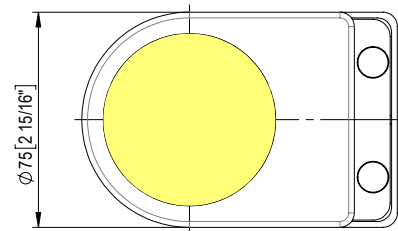
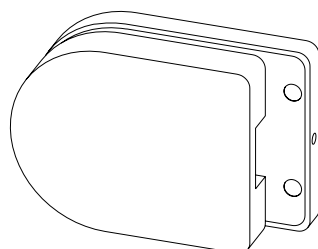

6736A

- Maniglie Hoppe Hcs completa di due cilindri.
- Juego de manillas Hoppe HCS con dos cilindros.
- Hoppe HCS lever handle with 2 cylinders.
- Drücker Hoppe HCS mit 2 Zylindern.
- Poignée Hoppe Hcs complétée de deux cylindres.

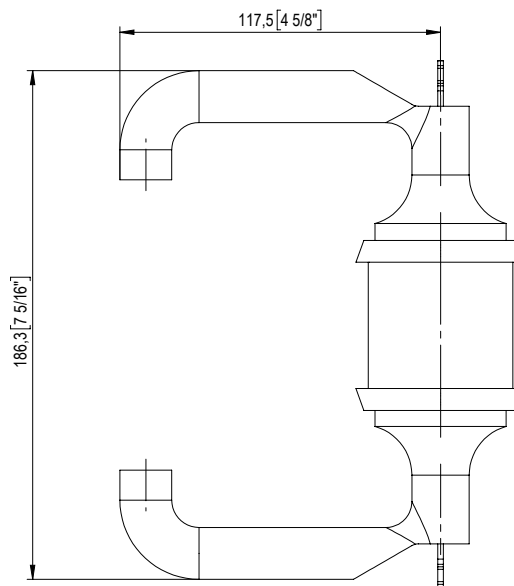
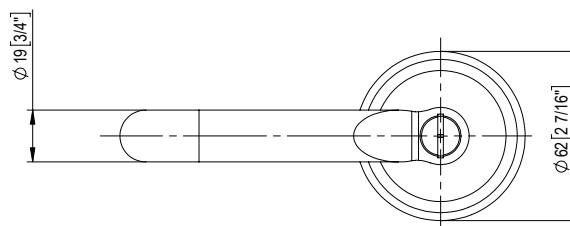
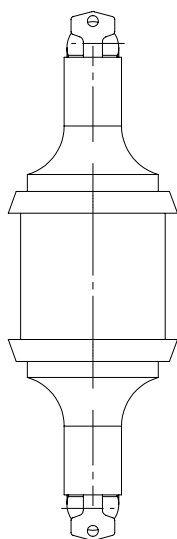
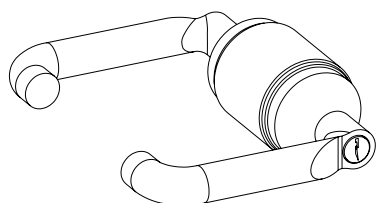

6736

- Maniglie Hoppe Hcs completa di cilindro e pomello.
- Juego de manillas Hoppe HCS con cilindro y pomo.
- Hoppe HCS lever handle with cylinder and knob.
- Drücker Hoppe HCS mit Knopf und Zylinder.
- Poignée Hoppe Hcs complétée de deux cylindres et bouton.

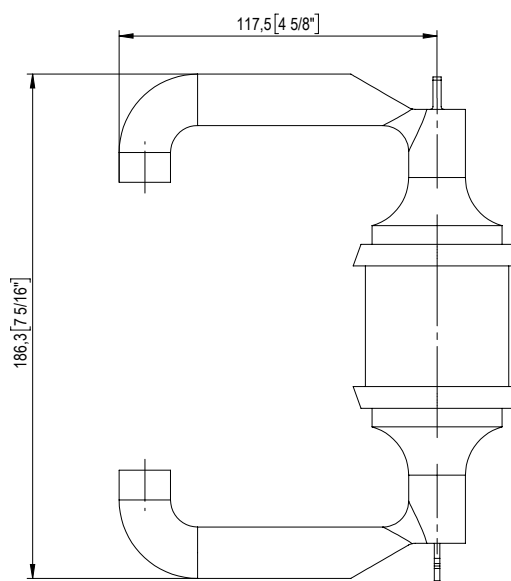
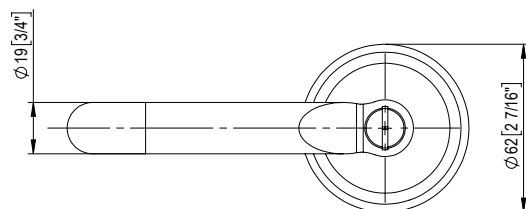
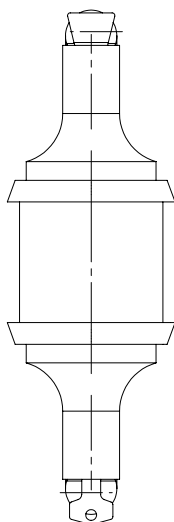
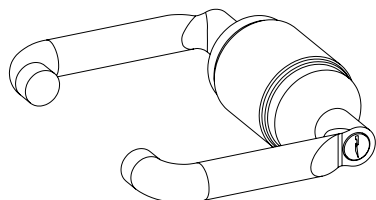

6H01

- Pomello nero.
- Pomo negro.
- Black knob.
- Schwarzer Knopf.
- Bouton noir.

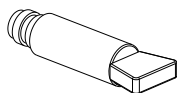

6H02

- Pomello ottone lucido.
- Pomo en latón brillante.
- Polished brass knob.
- Knopf aus glanzpoliertem Messing.
- Bouton noir en laiton poli.

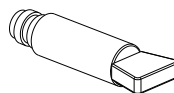

6H03

- Bottone scanalato nero.
- Perno acanalado, negro.
- Grooved black button.
- Schwarzer Knopf mit Rille.
- Bouton cannelé noir.

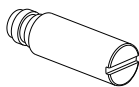

6H04

- Bottone scanalato ottone lucido.
- Perno acanalado en latón brillante.
- Grooved polished brass button.
- Knopf mit Rille aus glanzpoliertem Messing.
- Bouton cannelé en laiton poli.

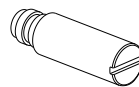

6H05

- Indicatore libero/occupato nero.
- Indicador libre/ocupado, negro.
- Black "free/engaged" indicator.
- Schwarzer Anzeiger "frei/besetzt".
- Indicateur libre/occupé noir.

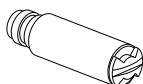

6H07

- Cilindro con chiave.
- Cilindro con llave.
- Cylinder with key.
- Zylinder mit Schlüssel.
- Cylindre avec clé.

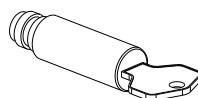

6040



6040-1

6040-2



Da specificare all'ordine
Please specify in detail
when ordering

- Serratura con chiavistello tondo doppia mandata senza tacca nel vetro.
- Cerradura sin muesca en el vidrio.
- Lock with rounded double turn dead bolt. Without cut in the glass.
- 2-fach schliessbares Schloss. Ohne Einschnitt im Glas.
- Serrure avec boulon rond à double tour sans encoche dans le verre.

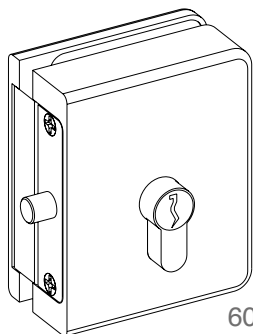
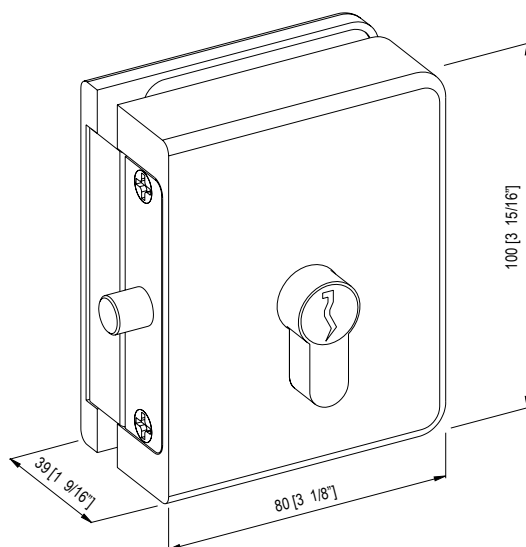

6040-1

0030

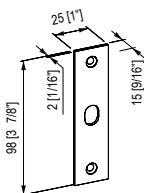

0035

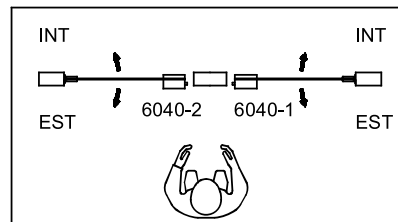
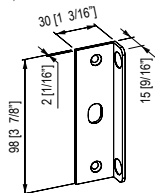

6050



Da specificare all'ordine
Please specify in detail
when ordering

- Controserratura per art. 6040.
- Cerradero sin muesca en el vidrio para art. 6040.
- Strike box for 6040.
- Gegenschloss für 6040.
- Gâche pour art. 6040.

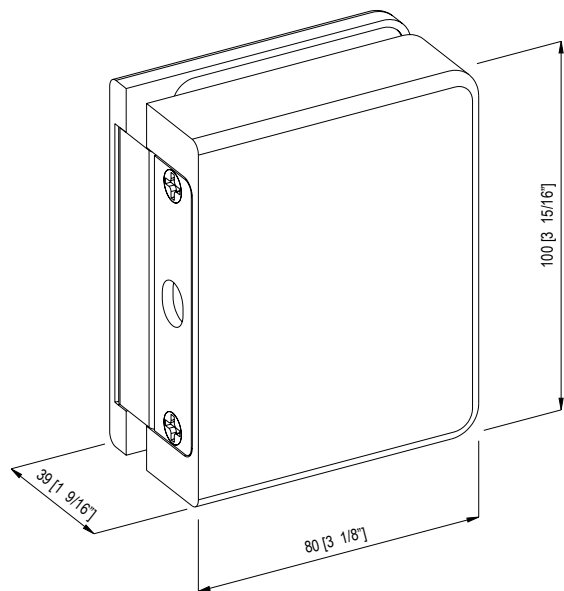
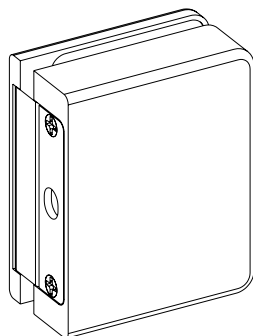

6630



- Serratura con chiavistello tondo doppia mandata.
- Cerradura sólo llave.
- Lock with rounded double turn dead bolt.
- 2-fach schliessbares Schloss.
- Serrure avec boulon à double jet.

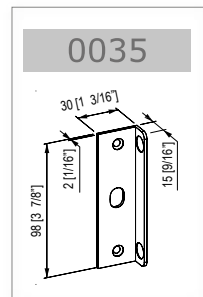
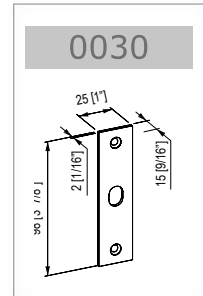
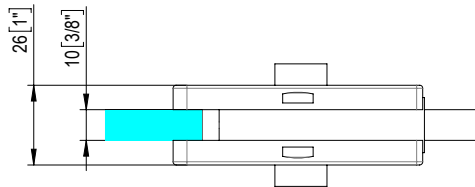
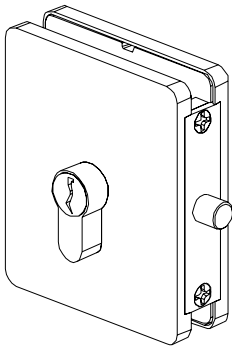
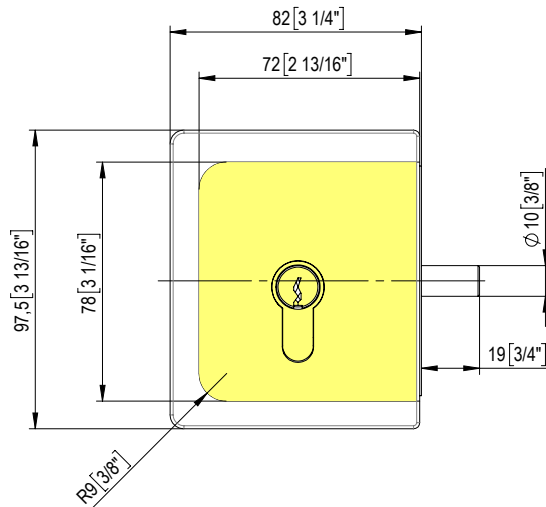

6830



- Controserratura per art. 6630.
- Cerradero sin tope para art. 6630.
- Strike box for 6630.
- Gegenschloss für 6630.
- Gâche pour art. 6630.

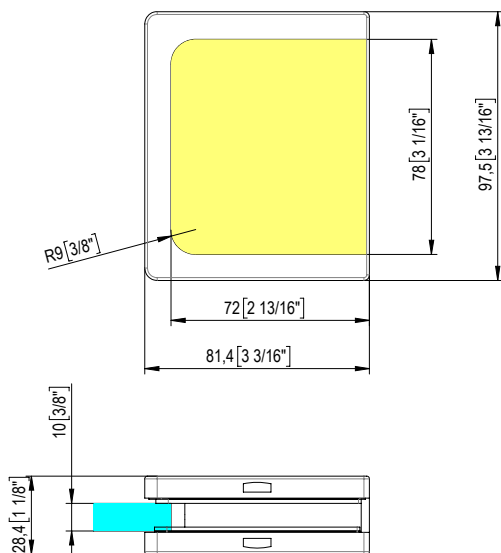
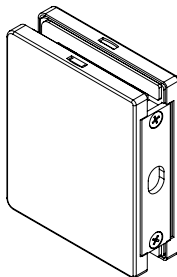

6835



- Controserratura con battuta per art.6630.
- Cerradero con tope, para art. 6630.
- Strike box with stop for 6630.
- Gegenschloss mit Anschlag für 6630.
- Gâche en butée pour art.6630.

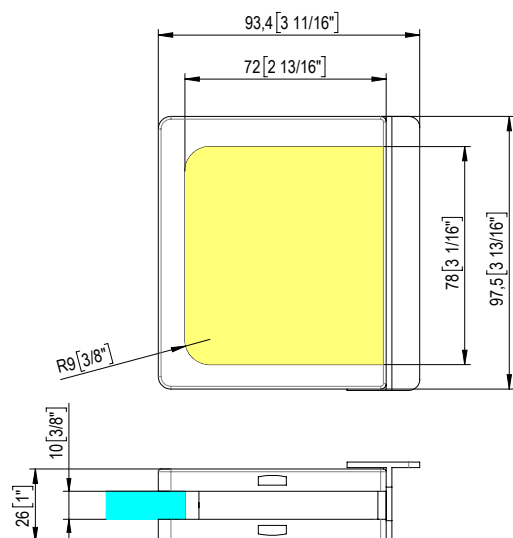
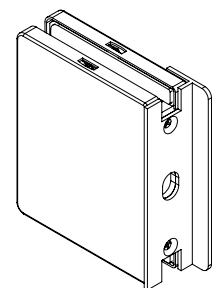

6640



- Serratura con scrocco più mandata.
- Cerradura solo llave.
- Leverless latch.
- Schloss mit Riegel und einmal Umdrehung.
- Serrure avec pêne et un tour.

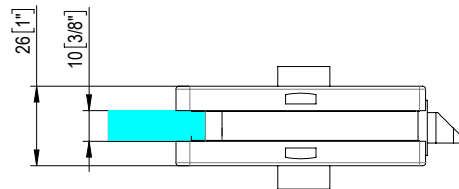
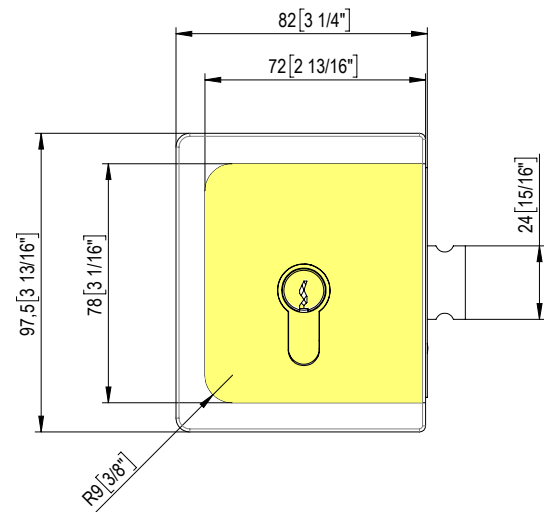
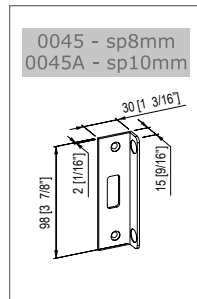
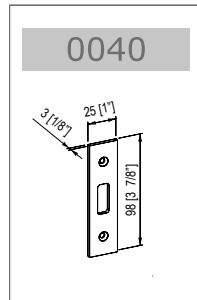
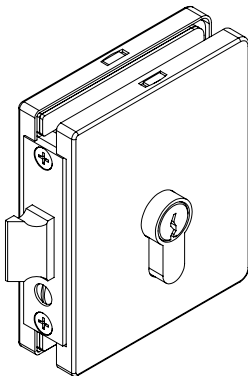

6645



- Serratura con doppio smusso (Olivetta) scrocco più mandata.
- Cerradura con doble cara (Olivetta).
- Leverless dual action latch (Olivetta).
- Doppelschräkantiges Schloss (Olivetta) mit Riegel und einmal Umdrehung.
- Serrure à double chanfrein. (Olivetta)

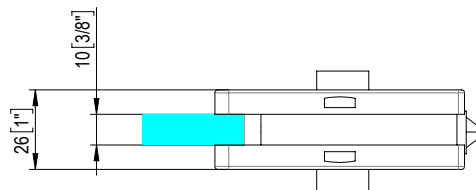
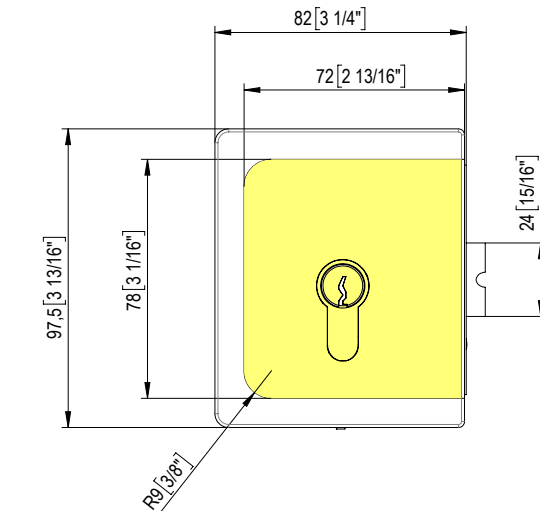
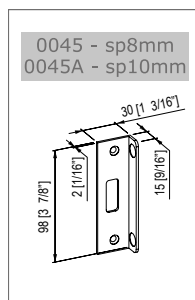
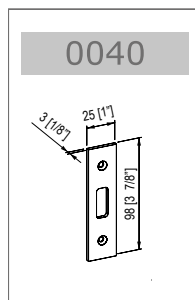
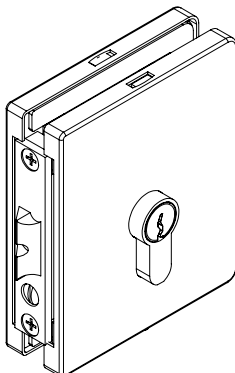

6840

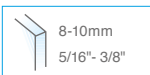

- Controserratura per art.6640-6641-6645.
- Cerradero vidrio sin tope para art. 6640-6641-6645.
- Strike box for 6640-6641-6645.
- Gegenschloss für 6640-6641-6645.
- Gâche pour art.art.6640-6641-6645.

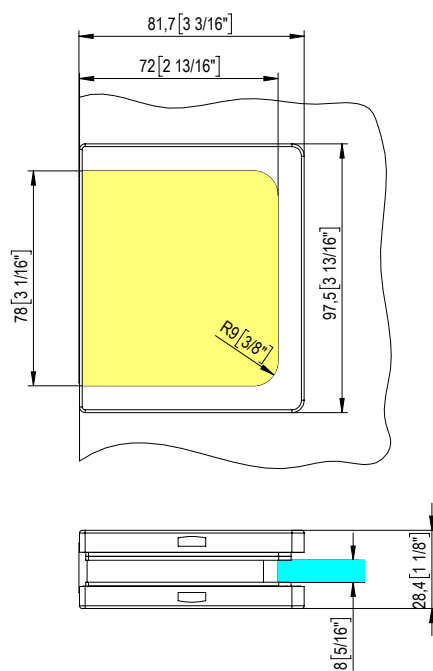
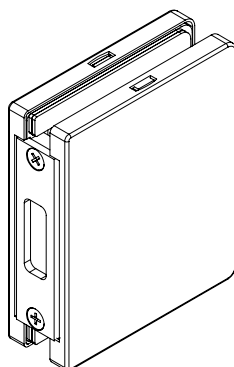

6845



- Controserratura con battuta per art. 6640-6641-6645.
- Cerradero vidrio con tope para art. 6640-6641-6645.
- Strike box with stop for 6640-6641-6645.
- Gegenschloss mit Anschlag für 6640-6641-6645.
- Gâche en butée pour art. 6640-6641-6645.

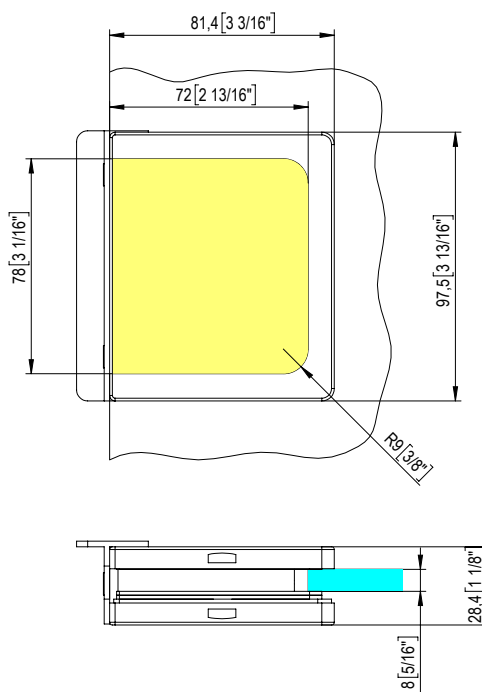
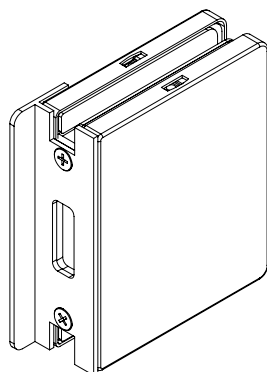

6870



- Incontro elettrico per art. 6640.
- Cerradura eléctrica para art. 6640.
- Electric strike plate for 6640.
- Elektrisches Gegenschloss für 6640.
- Gâche électrique pour art. 6640.

DC 12volt

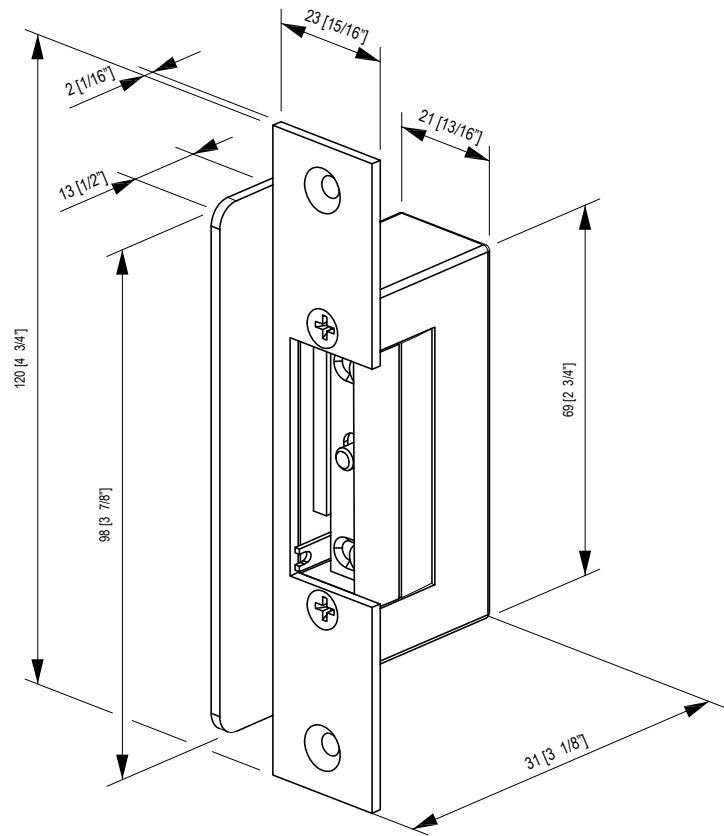
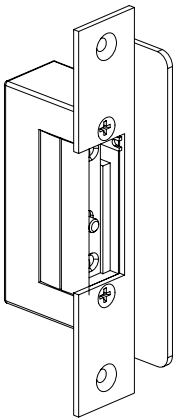

6875



- Controserratura elettrica per art.6640.
- Cerradero vidrio eléctrico para art. 6640.
- Electric strike box for 6640.
- Elektrisches Gegenschloss für 6640.
- Gâche électrique pour art.6640.

DC 12volt

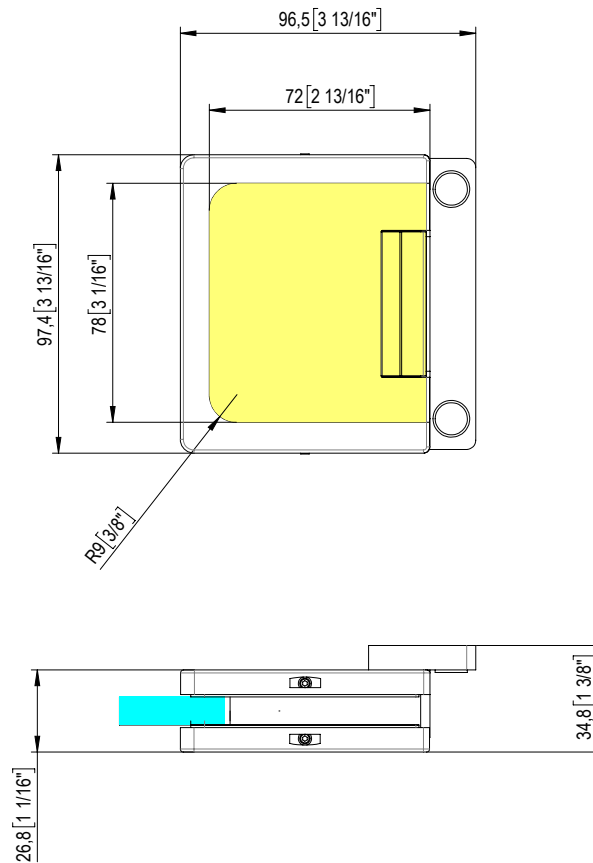
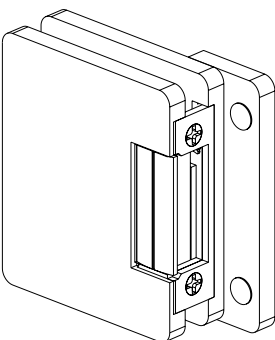

6650N

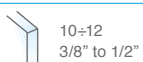

- Serratura orizzontale in battuta con foro per maniglia.
- Cerradura horizontal con tope y maneta.
- Horizontal lock with hole for handle. For doors with stop.
- Waagerechtes Schloss mit Loch für Türdrücker. Für Anschlagtüren.
- Serrure horizontale en butée avec trou pour la poignée.

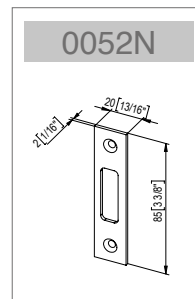
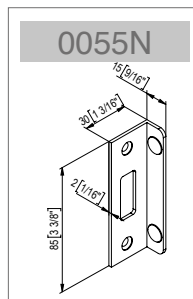
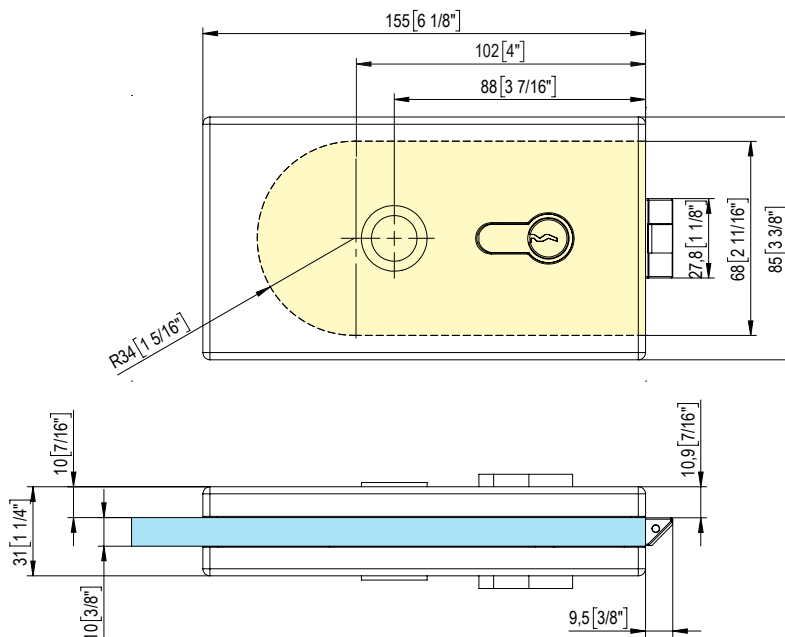
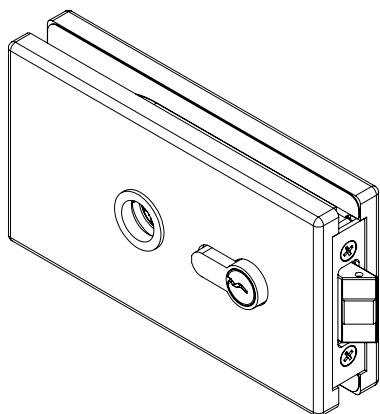

6855N

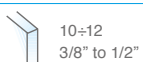

- Controserratura orizzontale.
- Cerradero horizontal.
- Horizontal strike box with stop.
- Waagerechtes Gegenschloss.
- Gâche horizontale.

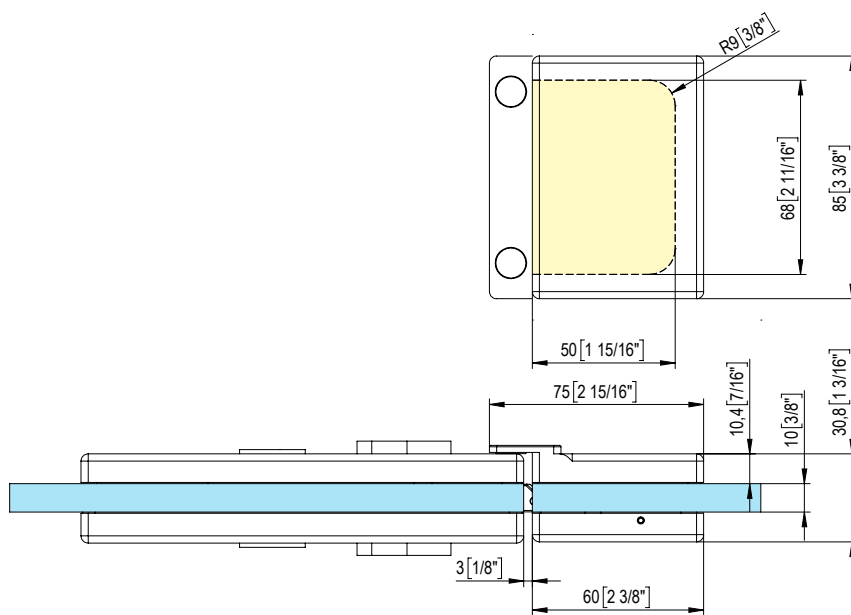
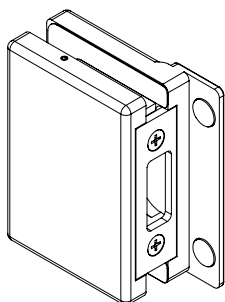

6652N



- Serratura orizzontale in battuta con foro per maniglia.
- Cerradura horizontal con tope y maneta.
- Horizontal lock with hole for handle. For doors with stop.
- Waagerechtes Schloss mit Loch für Türdrücker. Für Anschlagtüren.
- Serrure horizontale en butée avec trou pour la poignée.

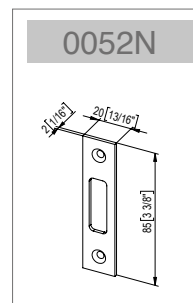
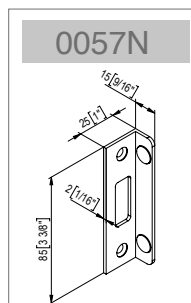
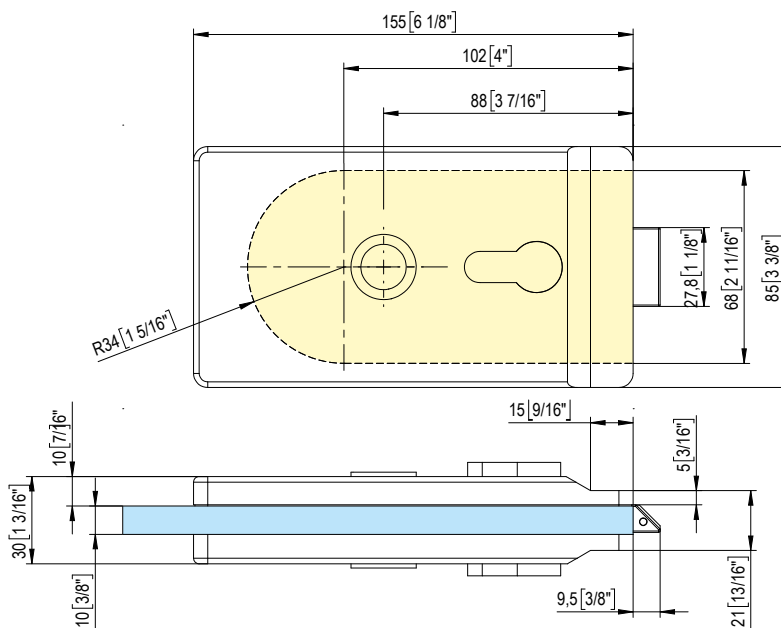
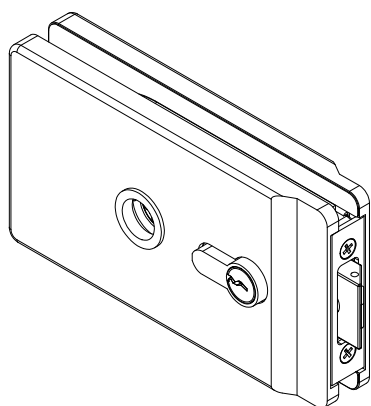

6852N



- Controserratura orizzontale.
- Cerradero horizontal.
- Horizontal strike box with stop.
- Waagerechtes Gegenschloss.
- Gâche horizontale.

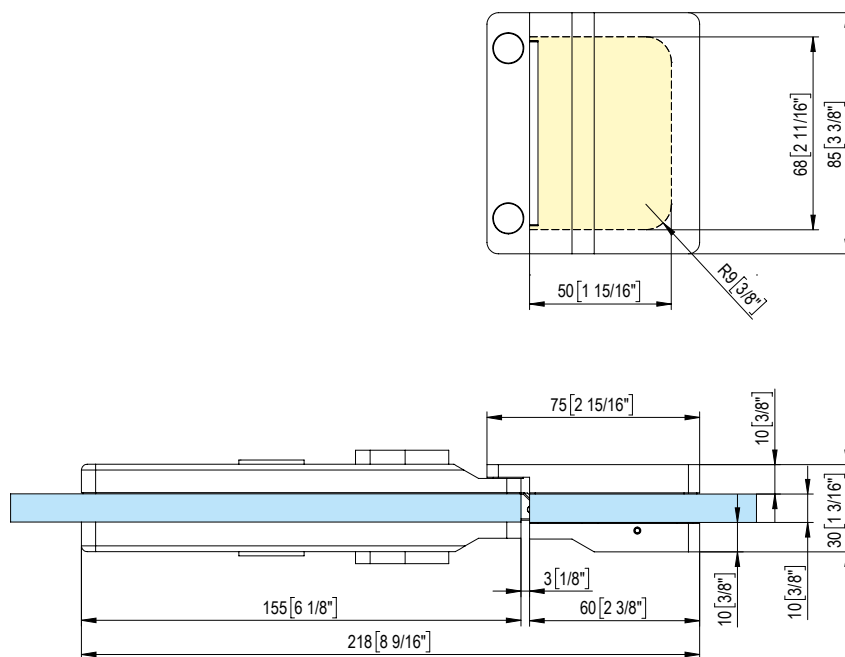
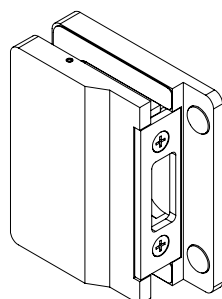

1030

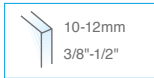

Da specificare all'ordine
Please specify in detail
when ordering

- Serratura stessa dimensione dell'art. 1010-1020.
- Cerradura inferior. De la misma dimension del art. 1010 - 1020.
- Corner lock. Same size of art. 1010 - 1020.
- Schloss mit den selben Maßen von 1010 - 1020.
- Serrure avec même dimension que l'art. 1010-1020.

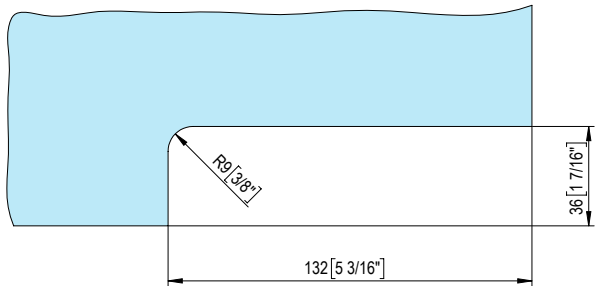
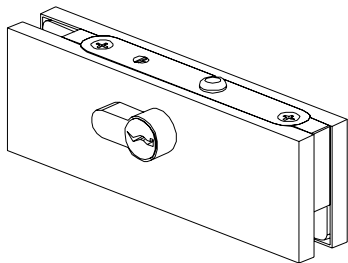
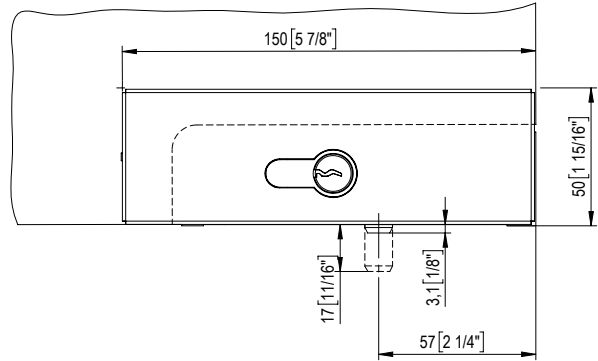
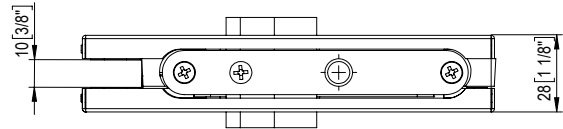
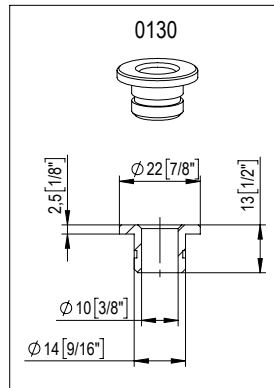

100E30

BILOBA
UNICA



- Serratura stessa dimensione dell'art. 101E10 - 100E20.
- Cerradura inferior. De la misma dimension del art. 101E10 - 100E20.
- Corner lock. Same size of art. 101E10 - 100E20.
- Schloss mit den selben Maßen von 101E10 - 100E20.
- Serrure avec même dimension que l'art. 101E10 - 100E20.

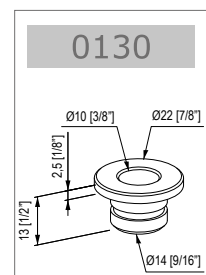
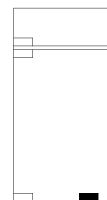
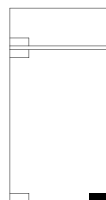
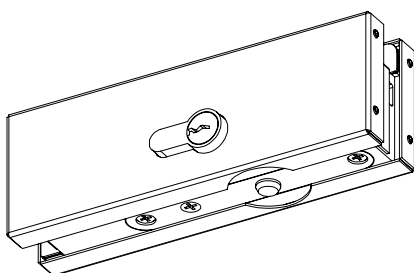
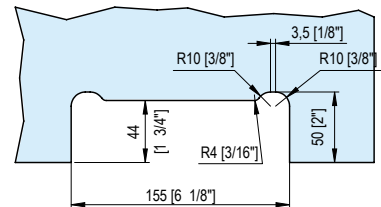
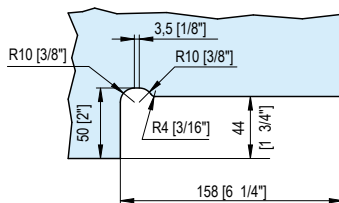
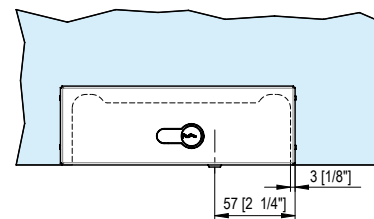
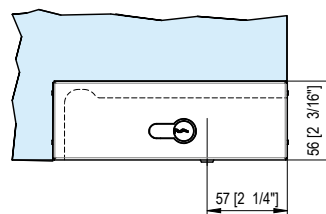
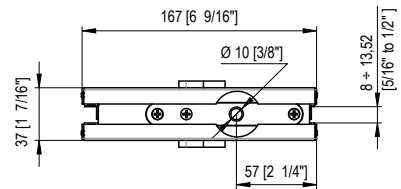

serrature / locks

LOQ

Alluminio / Aluminium - finiture / colors 02-05-14-15-16-17-31-32-60-62



681WSC



681W01



681W02



681W50



682WSC



682W01



682W02



682W50



683WSC



683W01



683W02



683W50



684WSC



684W01



684W02



684W50



685W30

MAGNETIC LOQ

Alluminio / Aluminium - finiture / colors 02-05-14-15-16-17-31-32-60-62



683WSCM



683W01M



683W02M



683W50M



684WSCM



684W01M



684W02M



684W50M



685W30M



686W30M

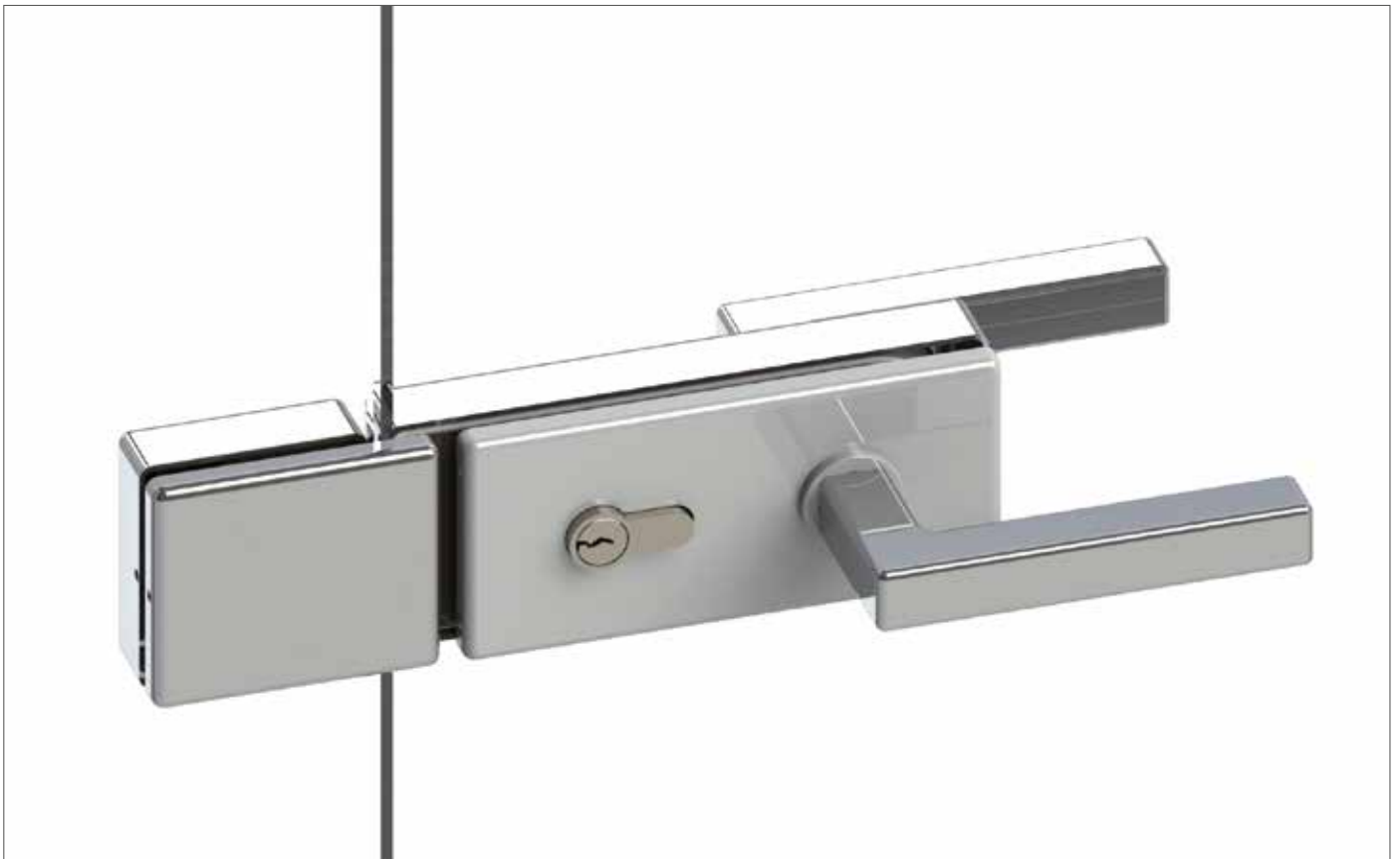

681WSC

LOQ



- Serratura orizzontale in battuta con foro maniglia e foro cilindro.
- Cerradura horizontal con cuadro manilla y cilindro.
- Horizontal lock with hole for handle and hole for cylinder.
- Horizontales Eckform-Schloss mit Drückerführung und für PZ-Schloss vorge richtet. Für Anschlagtüren.
- Serrure horizontale en butée avec trou pour la poignée et trou pour le cylindre.

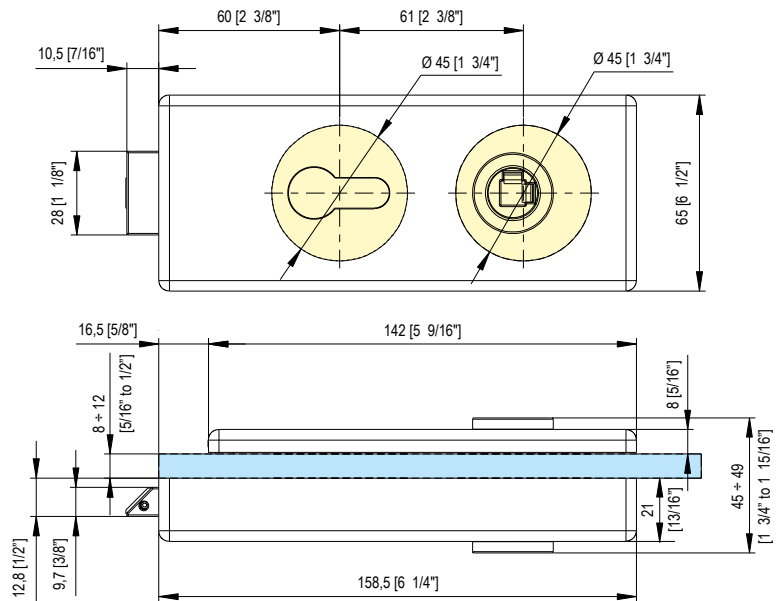
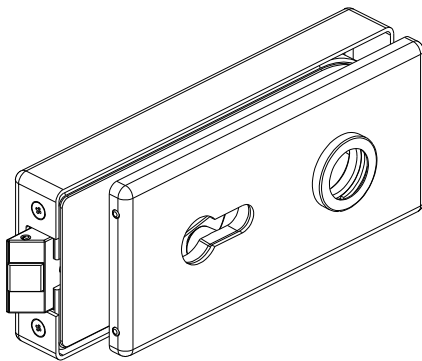

681W01

LOQ



- Serratura orizzontale in battuta solo foro maniglia.
- Cerradura horizontal con tope y cuadro manilla.
- Horizontal lock with hole for handle. For doors with stop.
- Horizontales Eckform-Schloss mit Drückerführung hinten. Für Anschlagtüren.
- Serrure horizontale en butée avec trou pour la poignée.

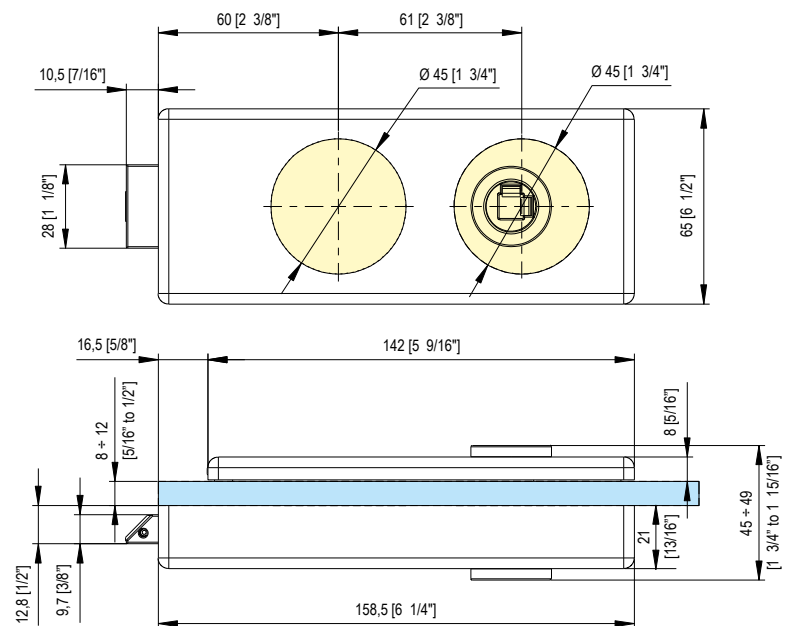
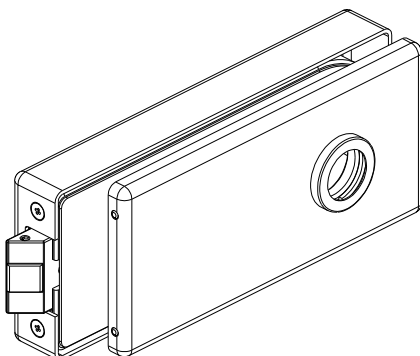

681W02

LOQ



- Serratura orizzontale in battuta solo foro maniglia.
- Cerradura horizontal con tope y cuadro manilla.
- Horizontal lock with hole for handle. For doors with stop.
- Horizontales Eckform-Schloss mit Drückerführung vorne. Für Anschlagtüren.
- Serrure horizontale en butée avec trou pour la poignée.

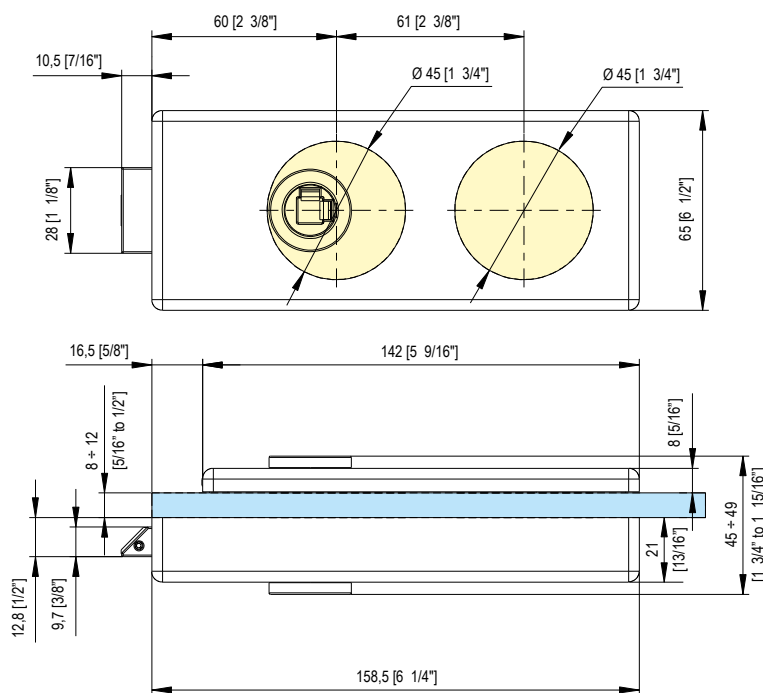
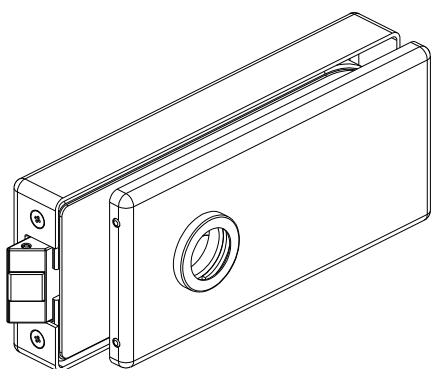

681W50

LOQ



- Controserratura orizzontale.
- Cerradero vidrio horizontal.
- Horizontal strike box with stop.
- Gegenkasten zum Eckform-Horizontalschloss.
- Gâche horizontale.

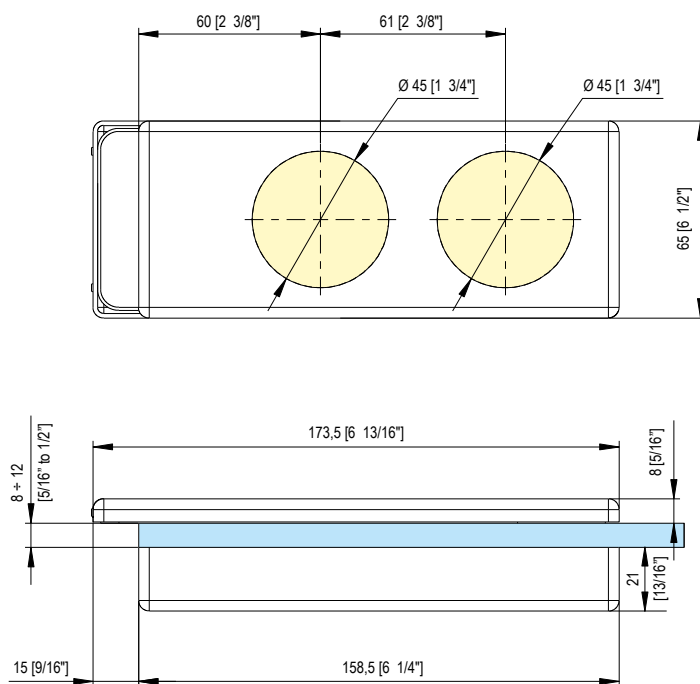
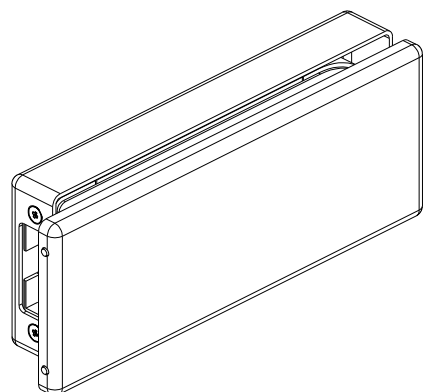

682WSC

LOQ



• Serratura orizzontale tonda in battuta con foro maniglia e foro cilindro.

• Cerradura horizontal redonda con tope y con cuadro para manilla y cilindro.

• Horizontal rounded lock with hole for handle and for cylinder. For doors with stop.

• Horizontales Rundform-Schloss mit Drückerführung für PZ-Schloss vorge richtet. Für Anschlagtüren.

• Serrure horizontale ronde en butée avec trou pour la poignée et trou pour le cylindre.

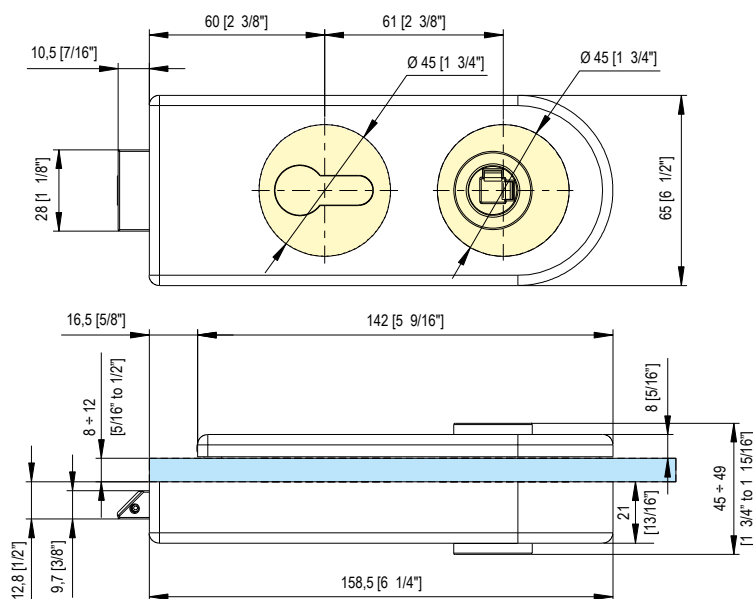
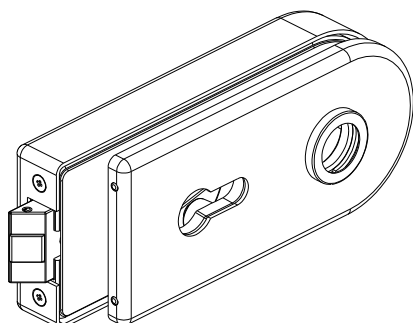

682W01

LOQ



• Serratura orizzontale tonda in battuta solo foro maniglia.

• Cerradura horizontal redonda con tope y con cuadro manilla.

• Horizontal rounded lock with hole for handle. For doors with stop.

• Horizontales Rundform-Schloss mit Drückerführung hinten. Für Anschlagtüren.

• Serrure horizontale ronde en butée avec trou pour la poignée.

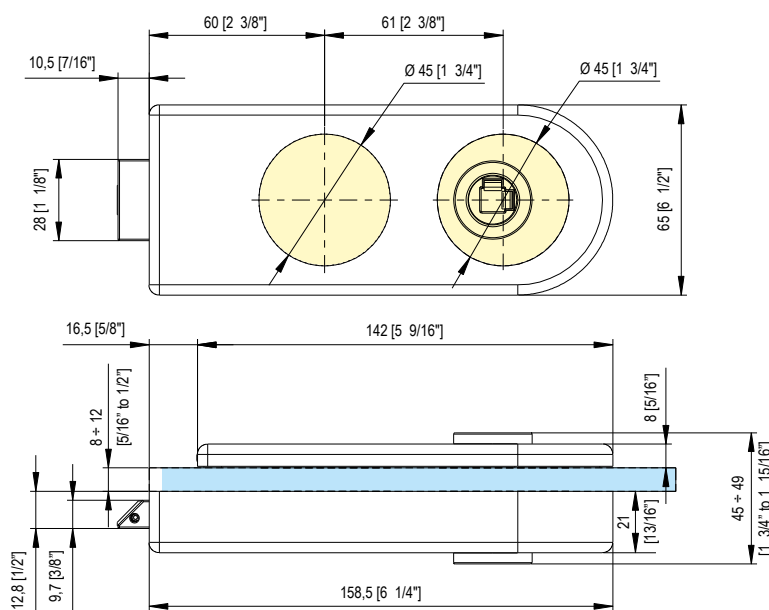
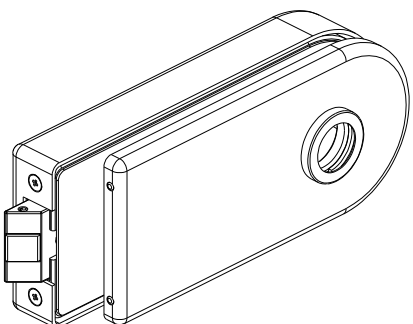

682W02

LOQ



- Serratura orizzontale tonda in battuta solo foro maniglia.
- Cerradura horizontal redonda con tope y con cuadro manilla.
- Horizontal rounded lock with hole for handle. For doors with stop.
- Horizontales Rundform-Schloss mit Drückerführung vorne. Für Anschlagtüren.
- Serrure horizontale ronde en butée avec trou pour la poignée.

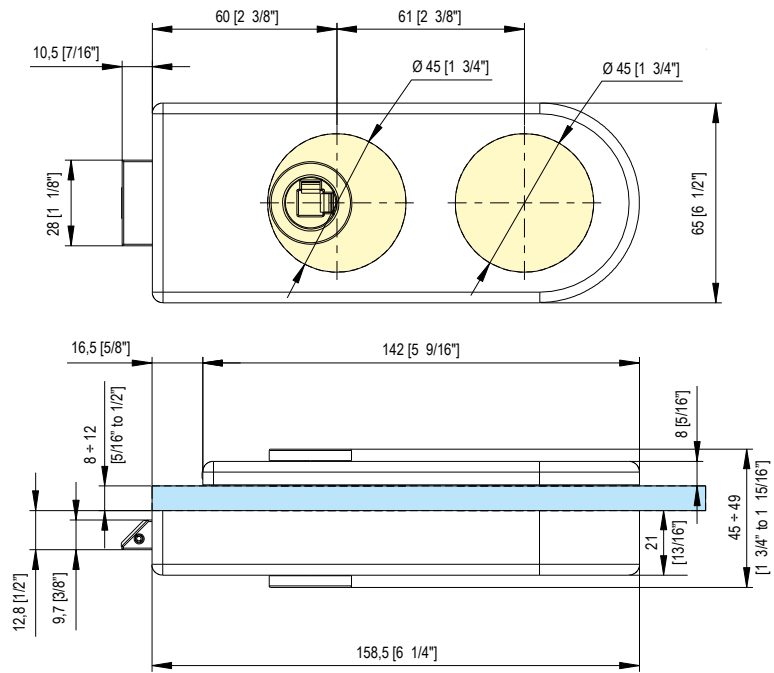
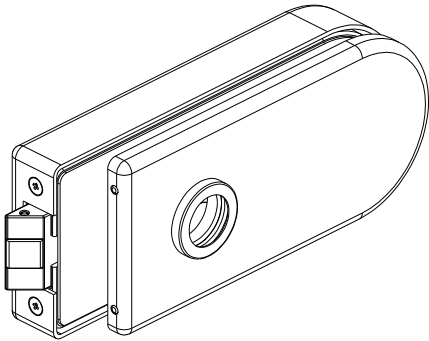

682W50

LOQ



- Controserratura orizzontale tonda.
- Cerradero horizontal redondo.
- Horizontal rounded strike box with stop.
- Gegenkasten zum Rundform-Horizontalschloss.
- Gâche horizontale ronde.

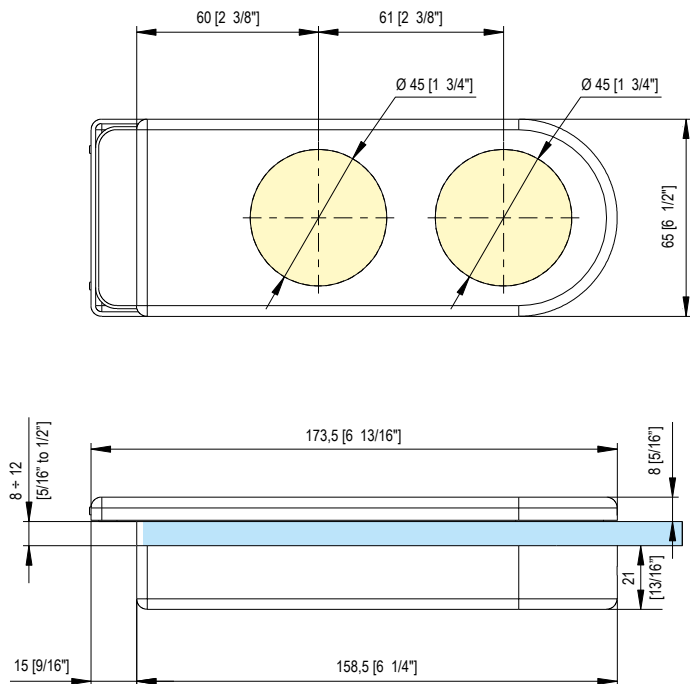
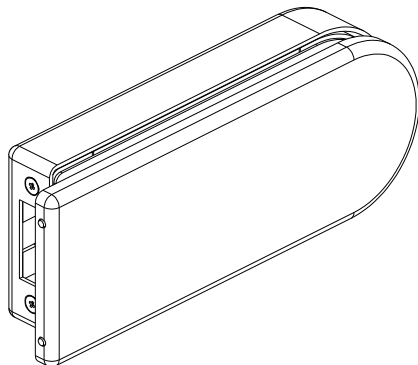

683WSC

LOQ



- Serratura orizzontale in battuta con foro maniglia e foro cilindro.
- Cerradura horizontal con tope y con cuadro manilla y cilindro.
- Horizontal lock with hole for handle and hole for cylinder. For doors with stop.
- Horizontales Eckform-Schloss mit Drückerführung und für PZ-Schloss vorbereitet. Für Anschlagtüren.
- Serrure horizontale en butée avec trou pour la poignée et trou pour le cylindre.

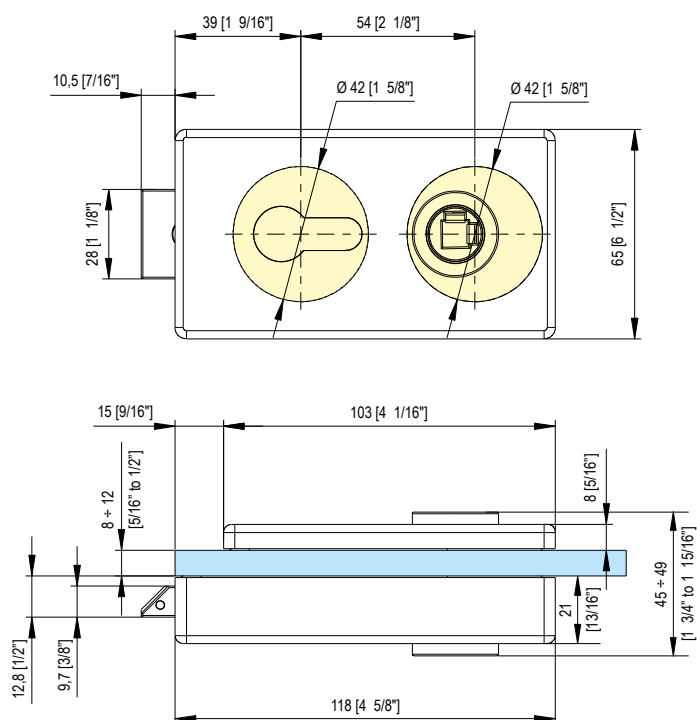
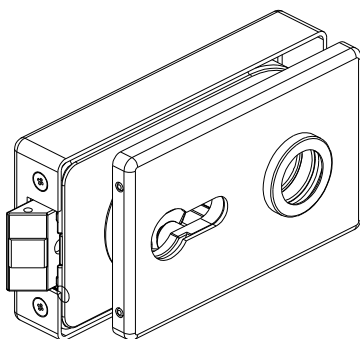

683W01

LOQ



- Serratura orizzontale in battuta solo foro maniglia.
- Cerradura horizontal con tope y con cuadro para manilla.
- Horizontal lock with hole for handle. For doors with stop.
- Horizontales Eckform-Schloss mit Drückerführung hinten. Für Anschlagtüren.
- Serrure horizontale en butée avec trou pour la poignée.

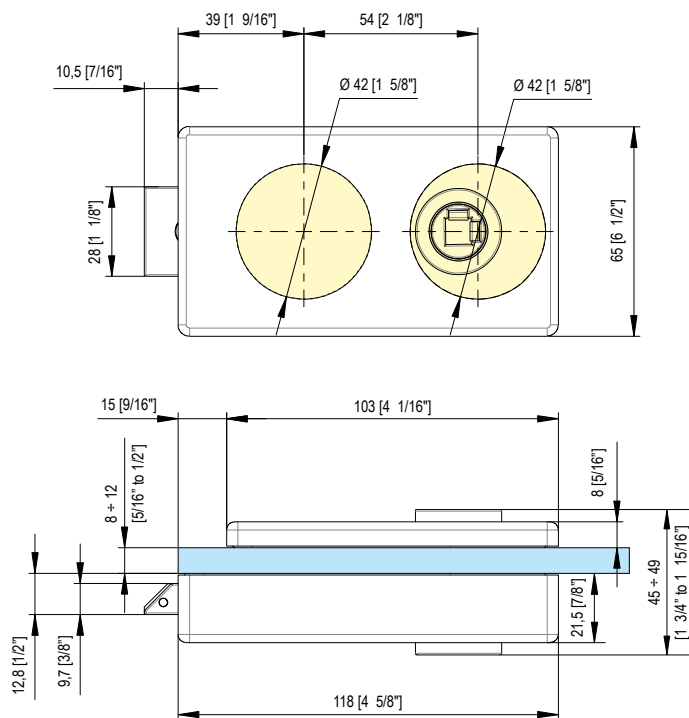
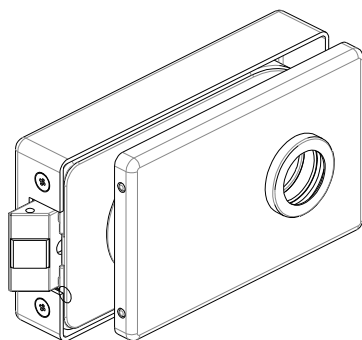

683W02

LOQ



- Serratura orizzontale in battuta solo foro maniglia.
- Cerradura horizontal con tope y con cuadro para manilla.
- Horizontal lock with hole for handle. For doors with stop.
- Horizontales Eckform-Schloss mit Drückerführung vorne. Für Anschlagtüren.
- Serrure horizontale en butée avec trou pour la poignée.

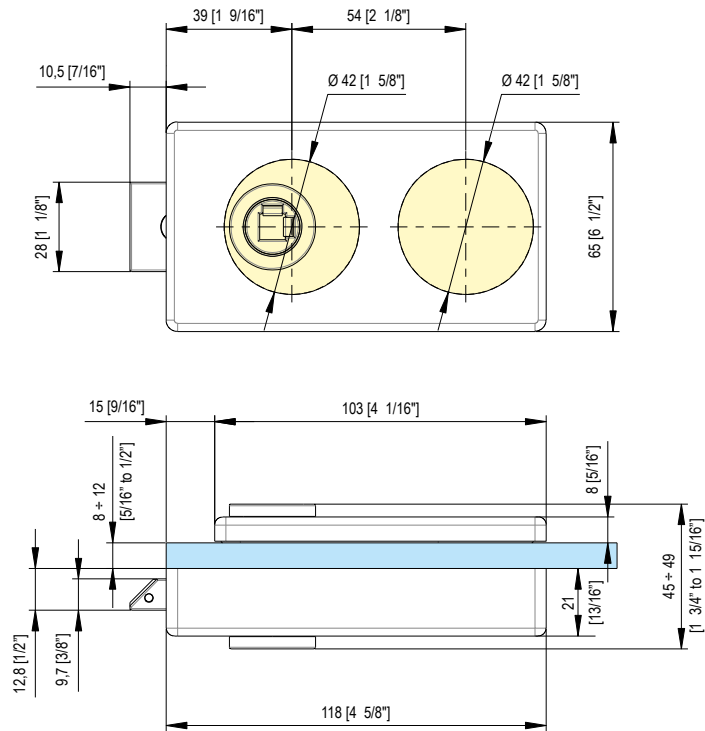
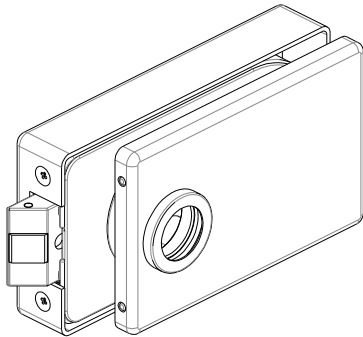

683W50

LOQ



- Controserratura orizzontale.
- Cerradero vidrio horizontal.
- Horizontal strike box with stop.
- Gegenkasten zum Eckform-Horizontalschloss.
- Gâche horizontale.

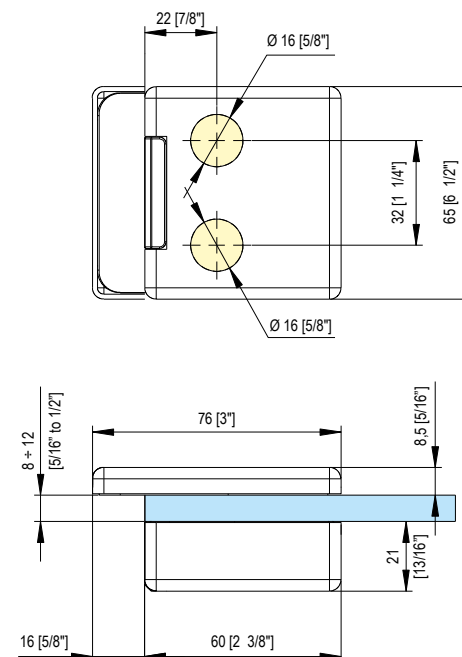
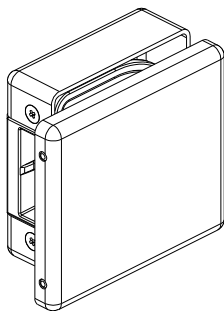

684WSC

LOQ



• Serratura orizzontale tonda in battuta con foro maniglia e foro cilindro.

• Cerradura horizontal redonda con tope y con cuadro para manilla y cilindro.

• Horizontal rounded lock with hole for handle and for cylinder. For doors with stop.

• Horizontales Rundform-Schloss mit Drückerführung für PZ-Schloss vorge richtet. Für Anschlagtüren.

• Serrure horizontale ronde en butée avec trou pour la poignée et trou pour le cylindre.

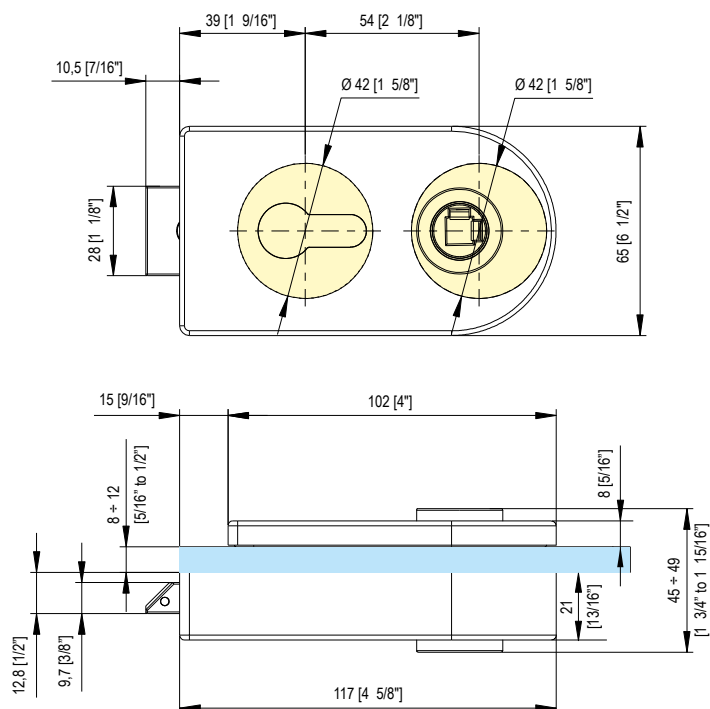
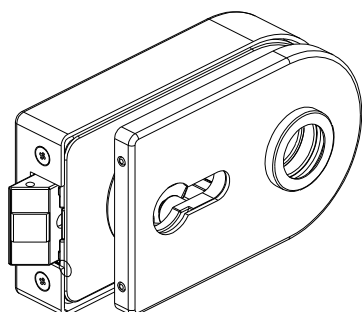

684W01

LOQ



• Serratura orizzontale tonda in battuta solo foro maniglia.

• Cerradura horizontal redonda con tope y con cuadro para manilla.

• Horizontal rounded lock with hole for handle. For doors with stop.

• Horizontales Rundform-Schloss mit Drückerführung hinten. Für Anschlagtüren.

• Serrure horizontale ronde en butée avec trou pour la poignée.

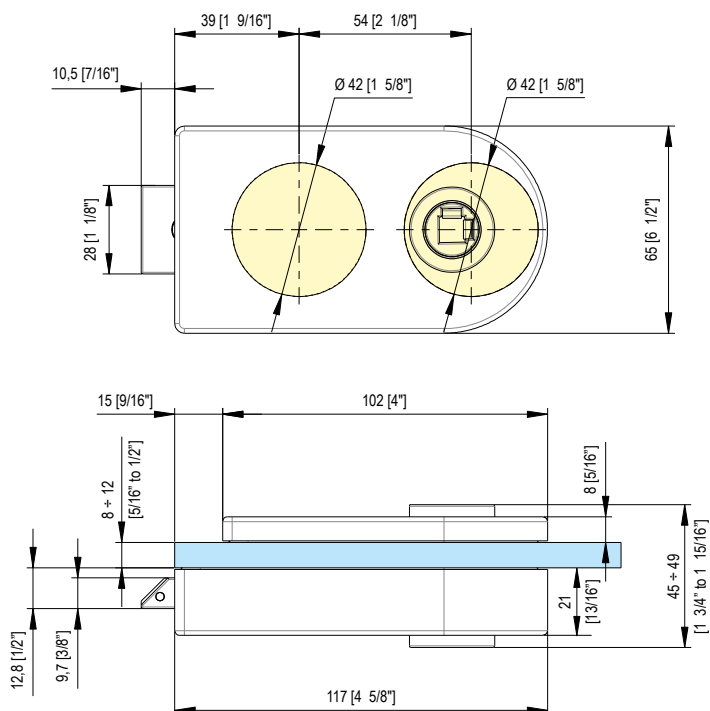
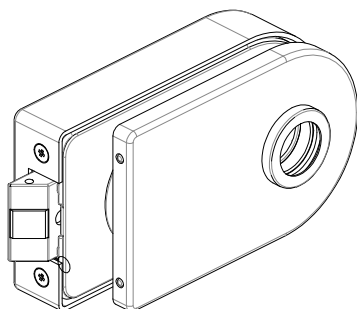

684W02

LOQ



- Serratura orizzontale tonda in battuta solo foro maniglia.
- Cerradura horizontal redonda con tope y con cuadro para manilla.
- Horizontal rounded lock with hole for handle. For doors with stop.
- Horizontales Rundform-Schloss mit Drückerführung vorne. Für Anschlagtüren.
- Serrure horizontale ronde en butée avec trou pour la poignée.

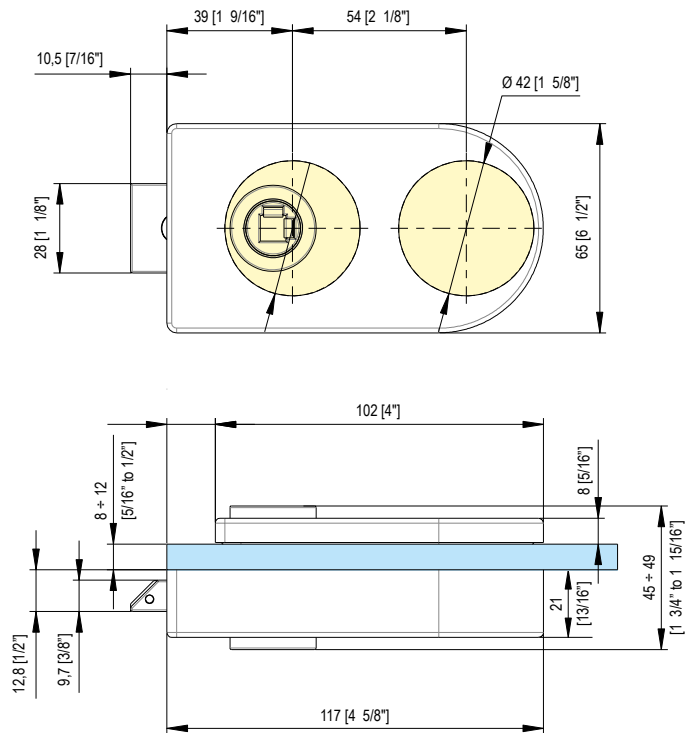
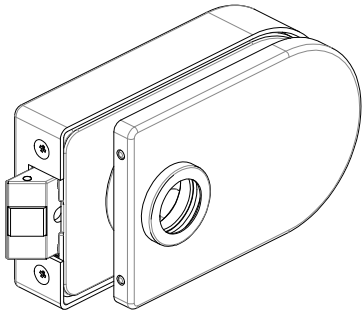

684W50

LOQ



- Controserratura orizzontale tonda.
- Cerradero horizontal redondo.
- Horizontal rounded strike box with stop.
- Gegenkasten zum Rundform-Horizontal-schloss.
- Gâche horizontale ronde.

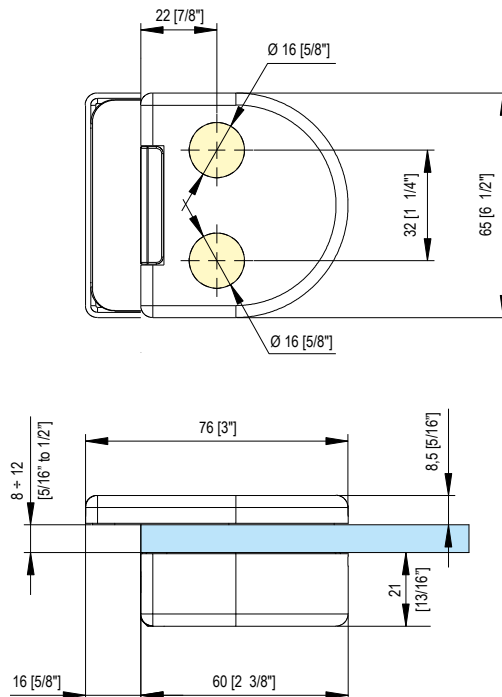
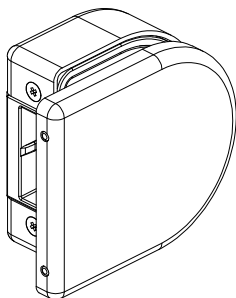

685W30



- Serratura per bagno con pomolo/coin con libero/occupato. Facile e veloce inversione pomolo-coin.
- Cerradura de baño con pomo libre/ocupado. Inversión de pomo y coin sencilla y rápida.
- Lock for bathrooms with free/occupied pull. Quick and easy knob/coin inversion.
- Eckform-Horizontal-WC-Schloss mit Drückerführung mit Knebel und Anzeige. Einfaches Umkehr vom Knopf und Coin.
- Serrure pour salle de bain avec indicateur libre/occupé. Facile inversion de bouton et fente. indicateur libre/occupé.

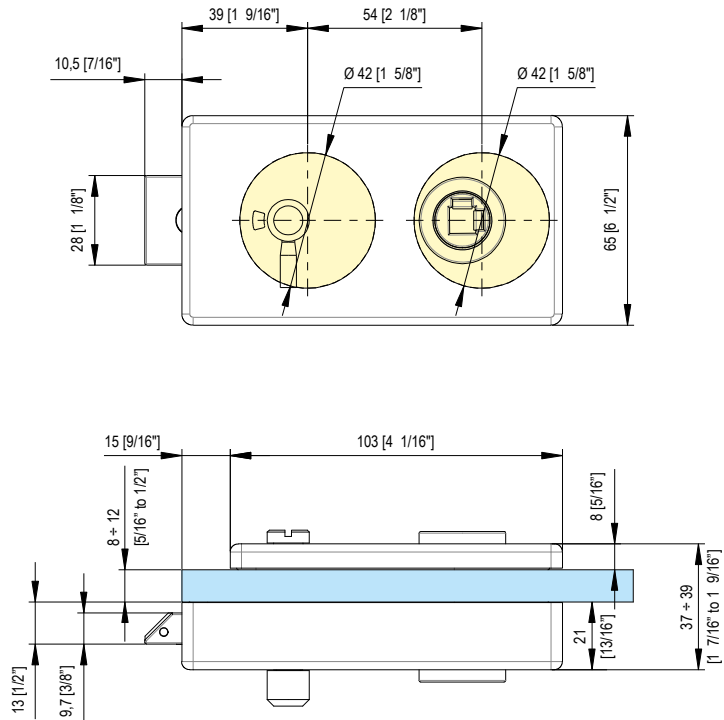
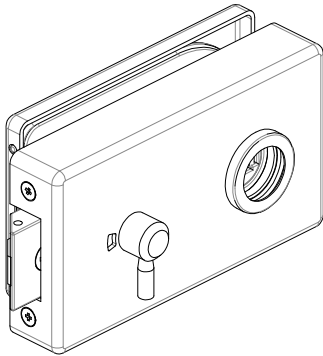

DIN L Shown

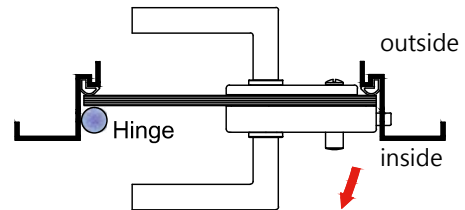
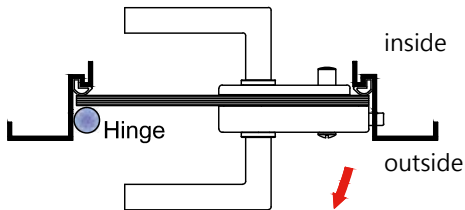

DIN R Shown

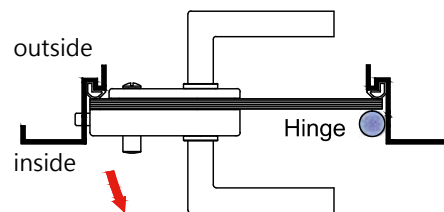
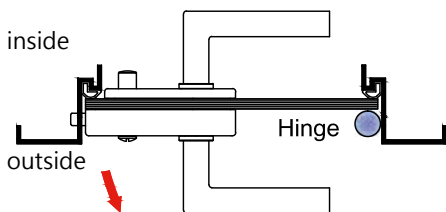

683WSCM

LOQ



• Serratura orizzontale in battuta "LOQ" con foro maniglia e foro cilindro. Scrocco magnetico.

• Cerradura horizontal con tope "LOQ" con agujeros para manilla y cilindro. Para puertas con tope. Estafa magnética.

• Horizontal lock "LOQ" with hole for handle and hole for cylinder. For doors with stop. Magnetic latch.

• Horizontales Eckform-Schloss "LOQ" mit Drückerführung und für PZ-Schloss vorgefertigt. Für Anschlagtüren. Magnetischen Riegel.

• Serrure horizontale «LOQ» avec trou pour poignée et trou pour cylindre. Pour les portes avec arrêt. Loquet magnétique.

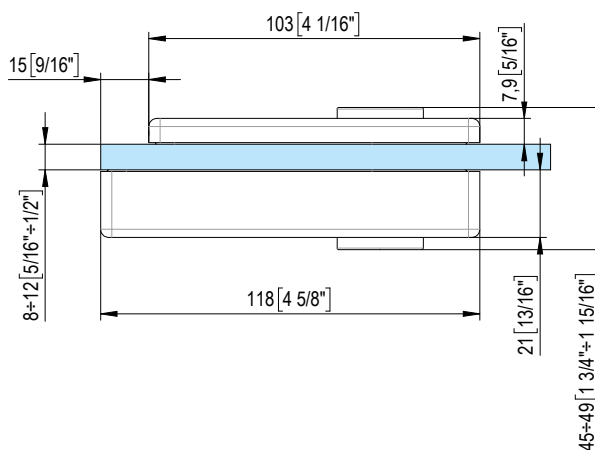
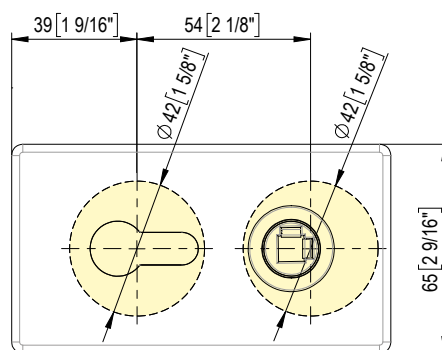
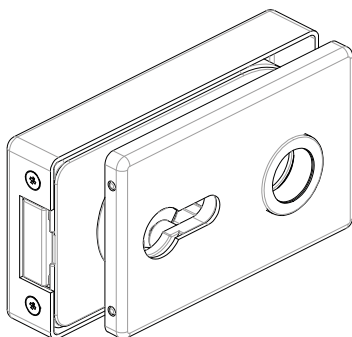

683W01M

LOQ



• Serratura orizzontale in battuta "LOQ" solo foro maniglia. Scrocco Magnetico.

• Cerradura horizontal con tope "LOQ" con agujero para manilla. Para puertas con tope. Estafa magnética.

• Horizontal lock "LOQ" with hole for handle. For doors with stop. Magnetic latch.

• Horizontales Eckform-Schloss "LOQ" mit Drückerführung. Für Anschlagtüren. Magnetischen Riegel.

• Serrure horizontale «LOQ» avec trou pour poignée. Pour les portes avec arrêt. Loquet magnétique.

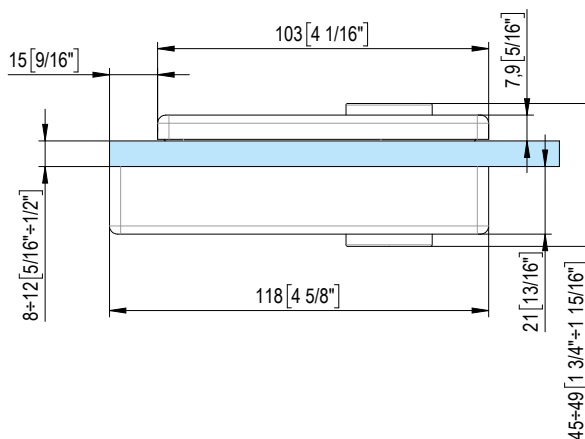
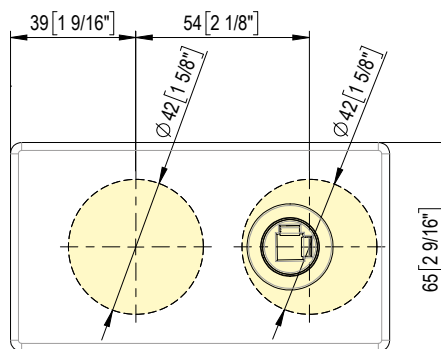
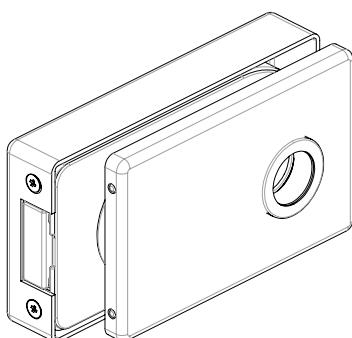

683W02M

LOQ



- Serratura orizzontale in battuta "LOQ" solo foro maniglia. Scrocco Mangetico.
- Cerradura horizontal con tope "LOQ" con agujero para manilla. Para puertas con tope. Estafa magnética.
- Horizontal lock "LOQ" with hole for handle. For doors with stop. Magnetic latch.
- Horizontales Eckform-Schloss "LOQ" mit Drückerführung. Für Anschlagtüren. Magnetischen Riegel.
- Serrure horizontale «LOQ» avec trou pour poignée. Pour les portes avec arrêt. Loquet magnétique.

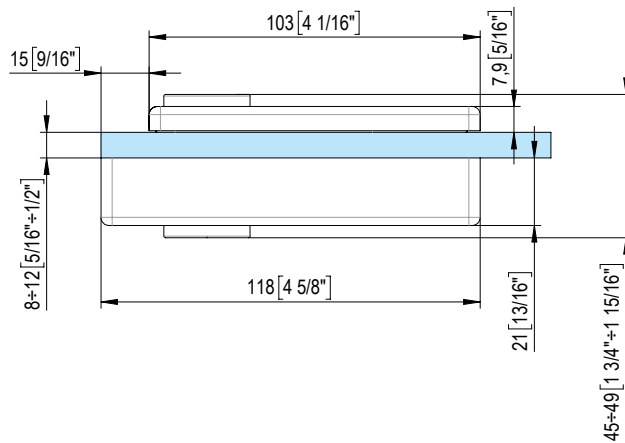
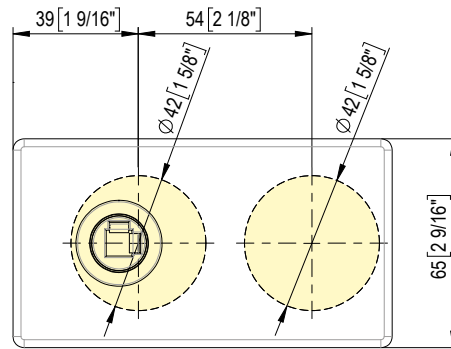
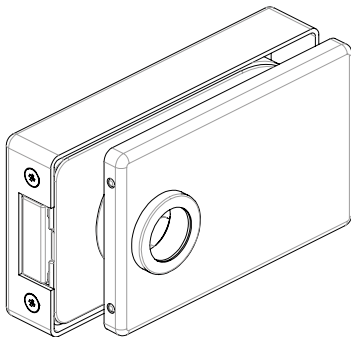

683W50M

LOQ



- Controserratura magnetica orizzontale in battuta "LOQ".
- Cerradero magnético con tope "LOQ".
- Magnetic lock keeper for jamb doors "LOQ".
- Magnetischen Gegenkasten "LOQ" zum Eckform-Horizontalschloss.
- Boîte de frappe horizontale «LOQ» avec arrêt. Loquet magnétique.

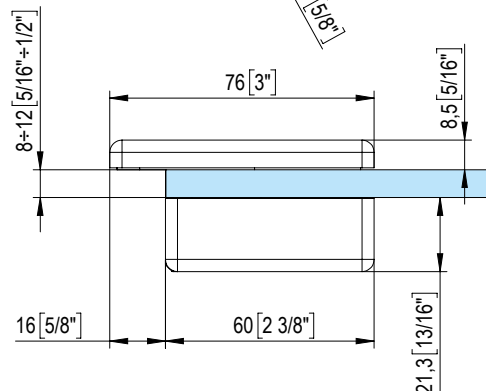
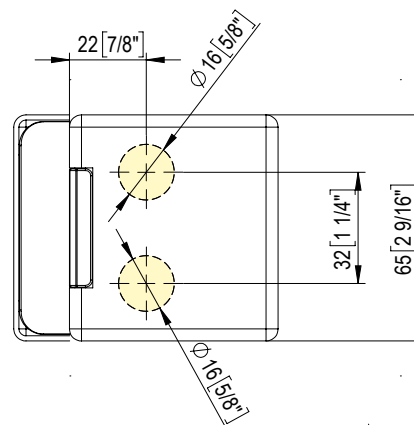
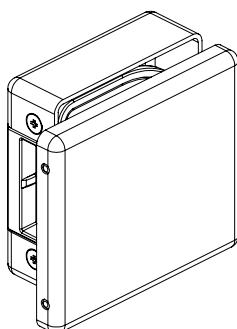

684WSCM

LOQ



• Serratura orizzontale tonda in battuta "LOQ" con foro maniglia e foro cilindro. Scocco magnetico.

• Cerradura horizontal redonda con tope "LOQ" con agujeros para manilla y cilindro. Para puertas con tope. Estafa magnética.

• Horizontal rounded lock "LOQ" with hole for handle and for cylinder. For doors with stop.

• Horizontales Rundform-Schloss "LOQ" mit Drückerführung für PZ-Schloss vorbereitet. Für Anschlagtüren. Magnetischen Riegel.

• Serrure arrondie horizontale «LOQ» avec trou pour poignée et cylindre. Pour les portes avec arrêt. Loquet magnétique.

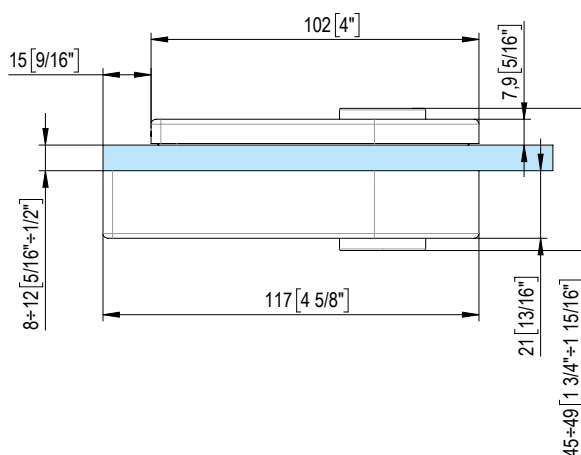
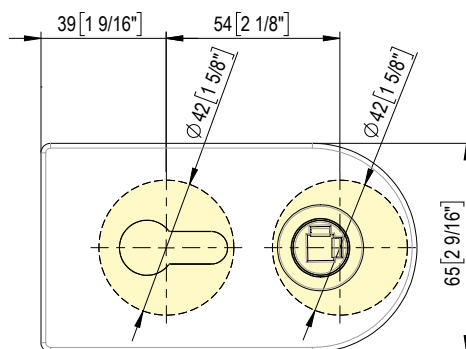
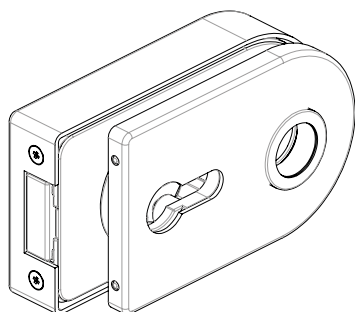

684W01M

LOQ



• Serratura orizzontale tonda in battuta "LOQ" soloforo maniglia. Scorro Magnetico.

• Cerradura horizontal redonda con tope "LOQ" con agujero para manilla. Para puertas con tope. Estafa magnética.

• Horizontal rounded lock "LOQ" with hole for handle. For doors with stop. Magnetic latch.

• Horizontales Rundform-Schloss "LOQ" mit Drückerführung. Für Anschlagtüren. Magnetischen Riegel.

• Serrure arrondie horizontale «LOQ» avec trou pour poignée. Pour les portes avec arrêt. Loquet magnétique.

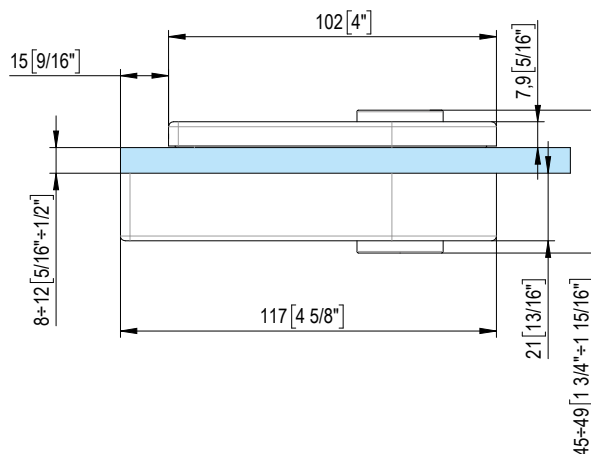
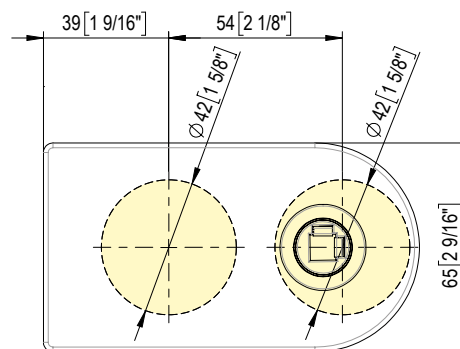
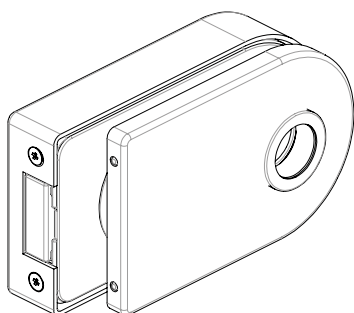

684W02M

LOQ



• Serratura orizzontale tonda in battuta "LOQ" soloforo maniglia. Scorro Magnetico.

• Cerradura horizontal redonda con tope "LOQ" con agujero para manilla. Para puertas con tope. Estafa magnética.

• Horizontal rounded lock "LOQ" with hole for handle. For doors with stop. Magnetic latch.

• Horizontales Rundform-Schloss "LOQ" mit Drückerführung. Für Anschlagtüren. Magnetischen Riegel.

• Serrure arrondie horizontale «LOQ» avec trou pour poignée. Pour les portes avec arrêt. Loquet magnétique.

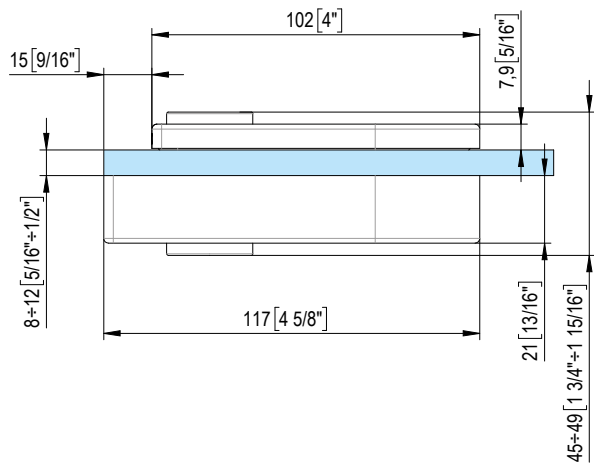
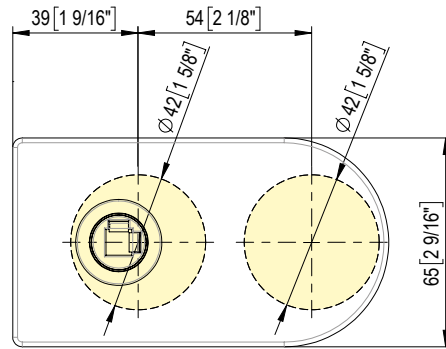
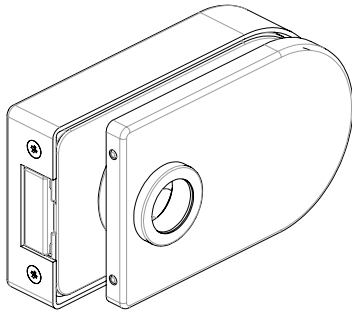

684W50M

LOQ



• Controserratura magnetica orizzontale tonda per porte in battuta "LOQ".

• Cerradero magnético redondo con tope "LOQ".

• Magnetic Horizontal rounded strike box "LOQ" with stop.

• Magnetischen Gegenkasten "LOQ" zum Rundform-Horizontalschloss.

• Boîte de frappe horizontale «LOQ» avec arrêt. Loquet magnétique.

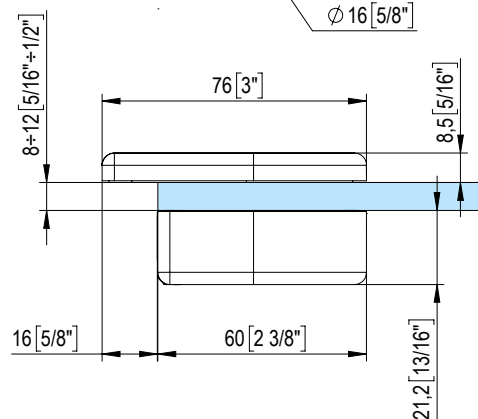
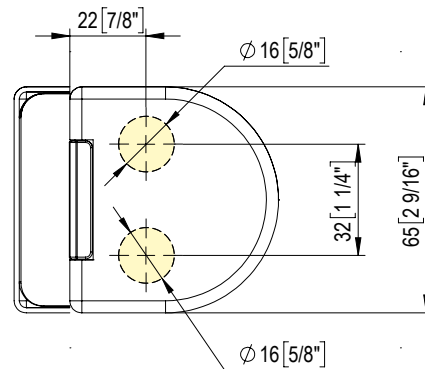
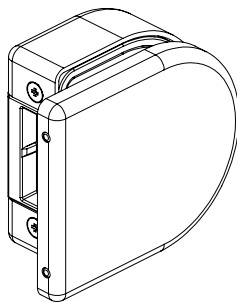

685W30M

LOQ



• Serratura per bagno con pomolo/coin con libero/occupato. Facile e veloce inversione pomolo-coin. Scrocco magnetico.

• Cerradura de baño con pomo libre/ocupado. Inversión de pomo y coin sencilla y rápida. Estafa magnética.

• Lock for bathrooms with free/occupied pull. Quick and easy knob/coin inversion. Magnetic latch.

• Eckform-Horizontal-WC-Schloss mit Drückerführung mit Knebel und Anzeige. Einfache Umkehr vom Knopf und Coin. Magnetischen Riegel.

• Serrure pour salle de bain avec tirette libre / occupée. Inversion rapide et facile des boutons / pièces. Loquet magnétique.

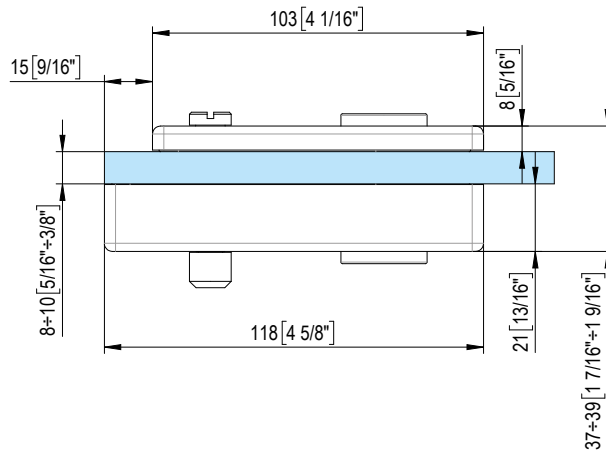
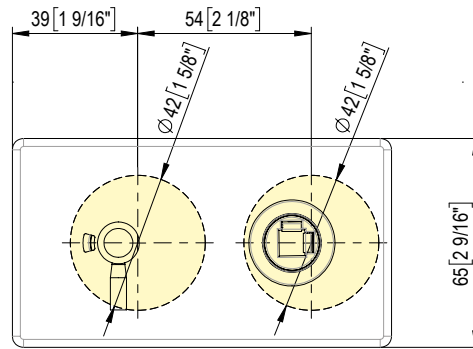
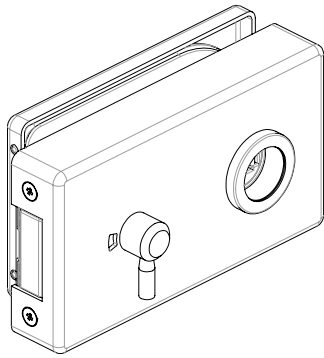

686W30M

LOQ

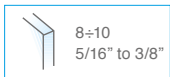

• Serratura tonda per bagno con pomolo/coin con libero/occupato. Facile e veloce inversione pomolo-coin. Scrocco magnetico.

• Cerradura de baño redonda con pomo libre/ocupado. Inversión de pomo y coin sencilla y rápida. Estafa magnética.

• Rounded Lock for bathrooms with free/occupied pull. Quick and easy knob/coin inversion. Magnetic latch.

• Rundform-Horizontal-WC-Schloss mit Drückerführung mit Knebel und Anzeige. Einfache Umkehr vom Knopf und Coin. Magnetischen Riegel.

• Serrure arrondie pour salle de bain avec tirette libre / occupée. Inversion rapide et facile des boutons / pièces. Loquet magnétique.

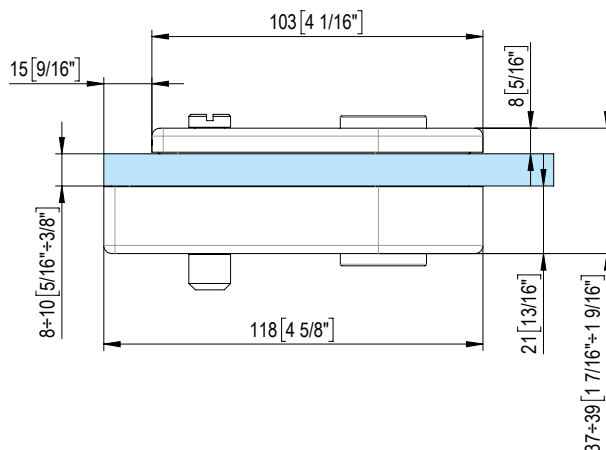
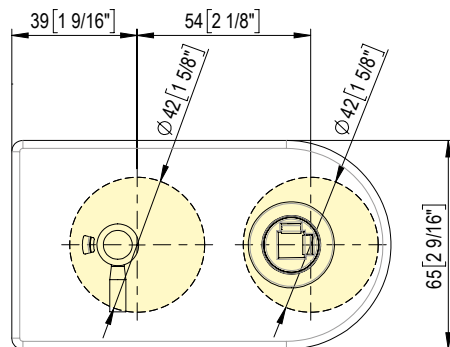
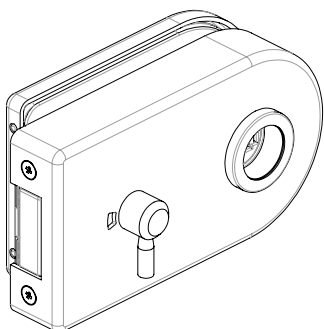

0683W11MGR LOQ



- Contro piastra magnetica piana per LOQ.
- Contra chapa magnética llana para cerraduras "LOQ".
- Magnetic plate for LOQ.
- Magnetische Gegenplatte für.
- Plaque magnétique pour serrures "LOQ".

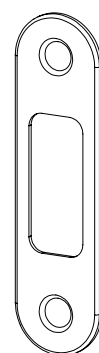
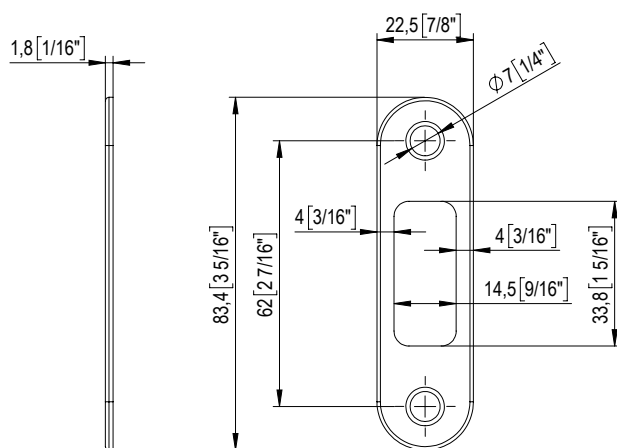
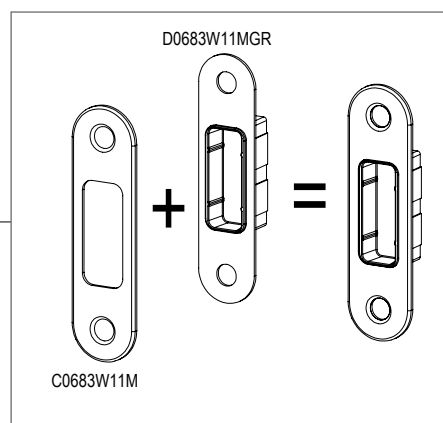
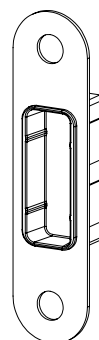
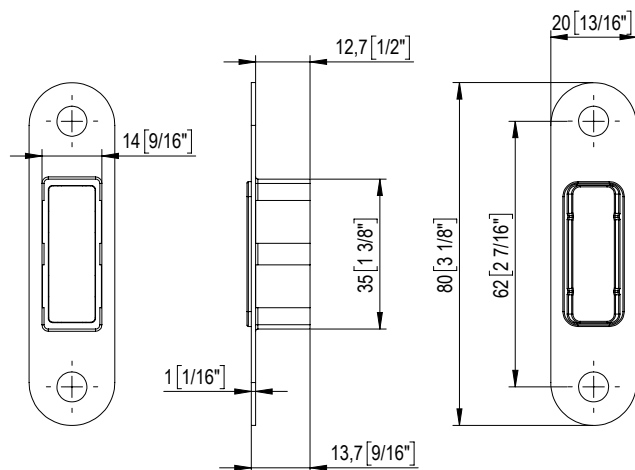

piastrine / plates

Alluminio / Aluminium



0671W10 finiture / colors 02-05-13-14 15-16-17-60

Alluminio / Aluminium



0671W16 finiture / colors 02-05-31-32-60

Alluminio / Aluminium



0671W17 finiture / colors 02-05-31-32-60

Alluminio / Aluminium



0681W20 finiture / colors 02-31-32-60

Alluminio / Aluminium



0681W21 finiture / colors 02-31-32-60

cilindri / cylinders

Alluminio / Aluminium



S1671W10

Alluminio / Aluminium



S1671W21

Alluminio / Aluminium



S1671W23

maniglie / handles

Alluminio / Aluminium



6606 finiture / colors 02-05 13-14-15-16-17-60-62

Alluminio / Aluminium



6610 finiture / colors 02-05 13-14-15-16-17-60-62

Alluminio / Aluminium



600E10 finiture / colors 02-05 13-14-15-16-17-60-62

Alluminio / Aluminium



601E10 finiture / colors 02-05 13-14-15-16-17-60-62

Alluminio / Aluminium



607W finiture / colors 02-05 13-14-15-16-17-60-62

Alluminio / Aluminium



608W finiture / colors 31-32-60-62

Alluminio / Aluminium



609W finiture / colors 31-32-60-62

Alluminio / Aluminium



610W finiture / colors 02-05 13-14-15-16-17-60-62

catenaccioli e fermaporta / latch and door stopper

Alluminio / Aluminium



A69 finiture / colors 02-05 14-15-16-17-31-60-62

Alluminio / Aluminium



A695 finiture / colors 02-05 14-15-16-17-31-60-62

Ottone / Brass



A86 finiture / colors 02-05 14-15-16-17-31-60-62

Alluminio / Aluminium



B19 finiture / colors 13-14-15-16-17-60

Alluminio / Aluminium



6M10/6M12 + 6M15 fin./col. 02-05-13-14-15-16-17-60-62

0671W10

- Contro piastrina con battuta.
- Contra chapa con tope.
- Counterplate with stop.
- Schließblech mit Anschlag.
- Gâche avec butée.

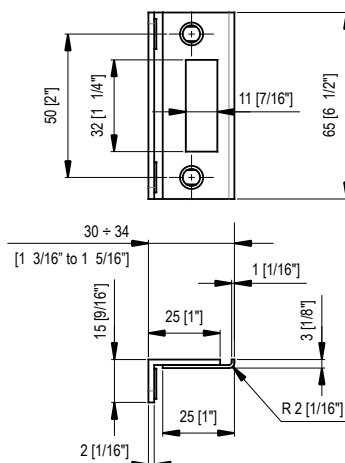
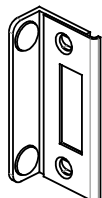

0671W16

- Contro piastrina.
- Contra chapa.
- Counterplate.
- Schließblech.
- Gâche.

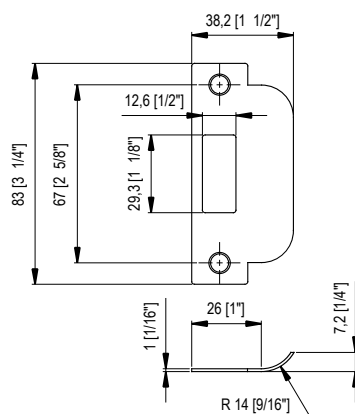
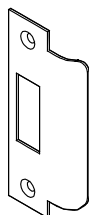

0671W17

- Contro piastrina.
- Contra chapa.
- Counterplate.
- Schließblech.
- Gâche.

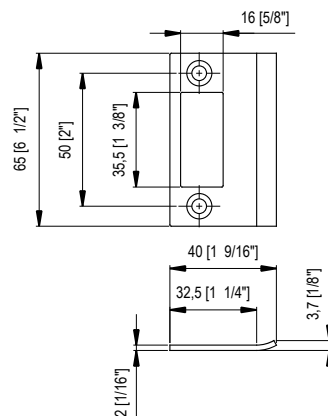
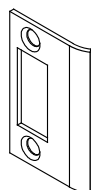

S1671W10

LOQ

- Cilindro chiave/chiave.
- Cilindro llave/llave.
- Cylinder key/key.
- Zylinder Schlüssel-Schlüssel.
- Cylindre clé/clé.

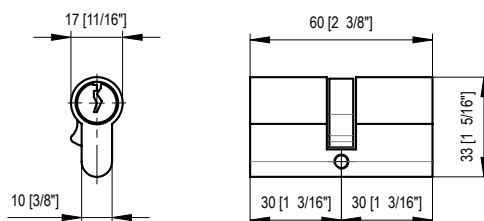
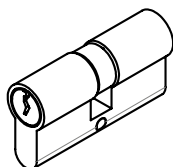

S1671W21

LOQ

- Cilindro chiave/pomolo.
- Cilindro llave/pomo.
- Cylinder key/pull.
- Zylinder Schlüssel-Knopf.
- Cylindre clé/bouton.

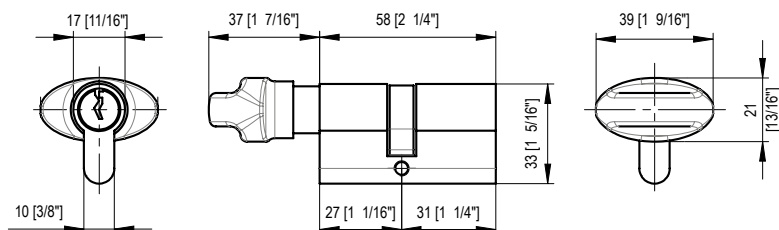
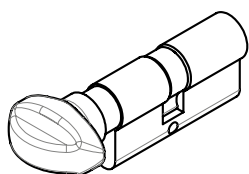

S1671W23

LOQ

- Cilindro pomolo/coin per porte bagno.
- Cilindro pomo/coin para puerta de baño.
- Cylinder pull/coin for bathroom doors.
- Zylinder Knopf-frei/besetzt für Toilettentüren.
- Cylindre bouton/pièce pour porte de salle de bain.

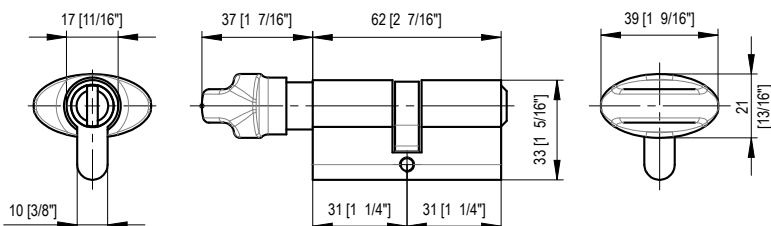
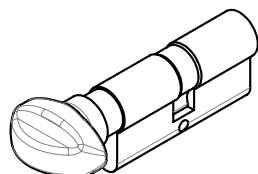

6606

- Maniglia standard.
- Manilla estándar.
- Standard lever handle.
- Standard Drücker.
- Poignée standard.

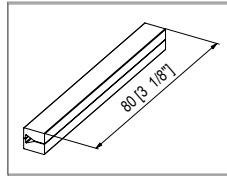

QUADRO MANIGLIA INCLUSO
CUADRO MANILLA INLCUIDO
INCLUDED LEVER HANDLE FIT
INKLUSIVE TÜRGRIFFSTIFT
CADRE CARRÉ INCLUS

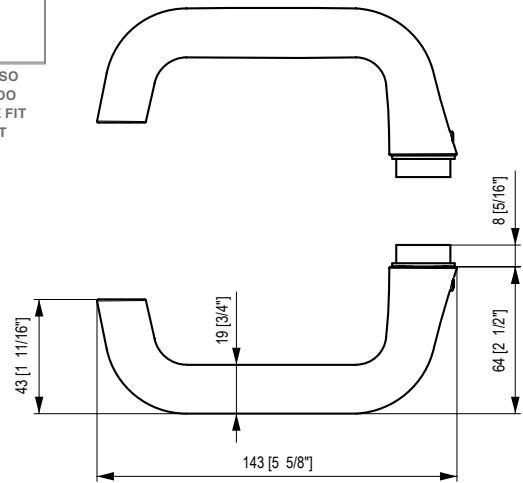
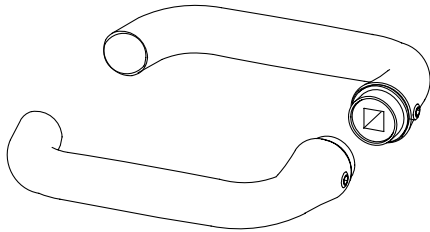

6610



- Maniglia con pomolo in folle.
- Manilla con pomo en punto muerto.
- Lever handle with dead knob.
- Drücker mit Losknopf.
- Poignée avec bouton à l'arrêt.

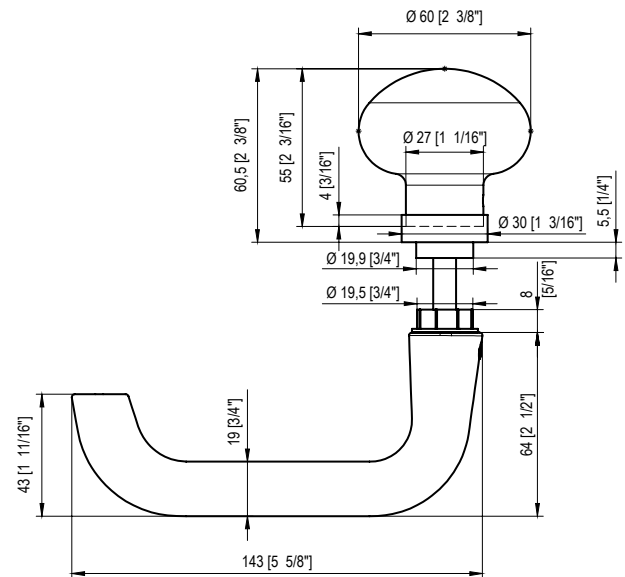
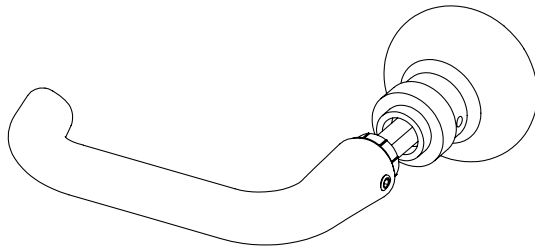

600E10

- Maniglia quadrata in alluminio.
- Manilla cuadrada en aluminio.
- Aluminium square lever handle.
- Viereckiger Drücker aus Aluminium.
- Poignée carrée en aluminium.

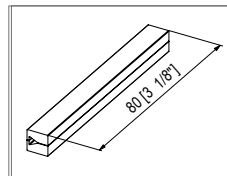

QUADRO MANIGLIA INCLUSO
CUADRO MANILLA INLCUIDO
INCLUDED LEVER HANDLE FIT
INKLUSIVE TÜRGRIFFSTIFT
CADRE CARRÉ INCLUS

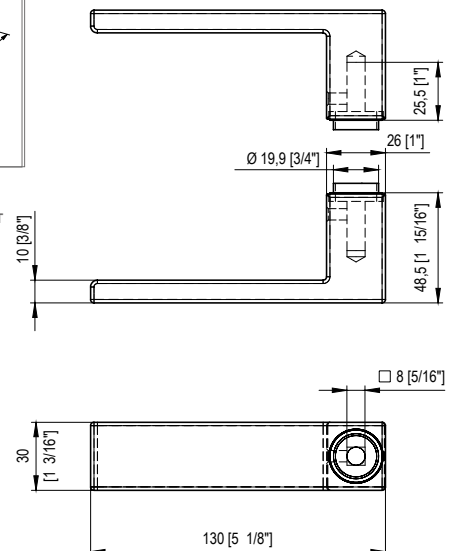
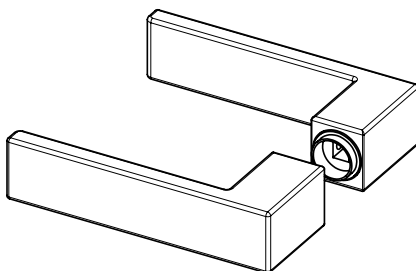

601E10

- Maniglia ergonomica in alluminio.
- Manilla ergonómica en aluminio.
- Aluminium ergonomic lever handle.
- Ergonomischer Drücker aus Aluminium.
- Poignée ergonomique en aluminium.

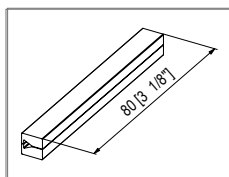

QUADRO MANIGLIA INCLUSO
CUADRO MANILLA INLCUIDO
INCLUDED LEVER HANDLE FIT
INKLUSIVE TÜRGRIFFFSTIFT
CADRE CARRÉ INCLUS

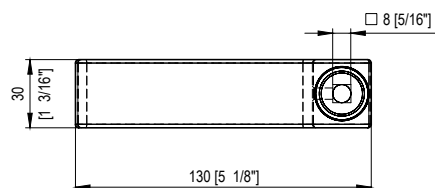
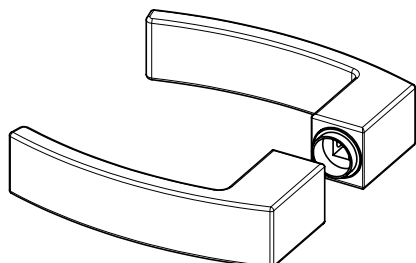
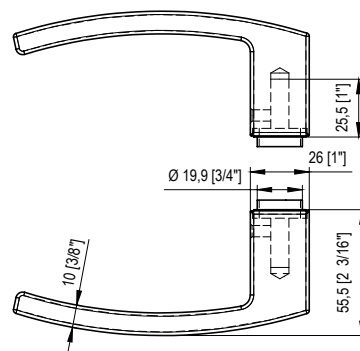

607W

- Maniglia sezione quadra. Quadro maniglia incluso.
- Manilla cuadrada. Cuadro manilla incluido.
- Square handle. Internal mechanism included.
- Viereckiger Drücker. Innenmechanismus eingeschlossen.
- Poignée carrée. Mecanisme intérieur inclus.

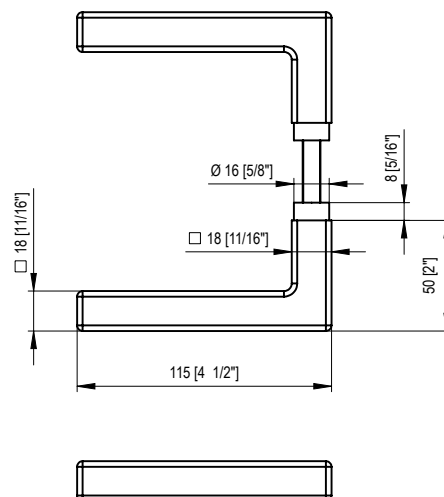
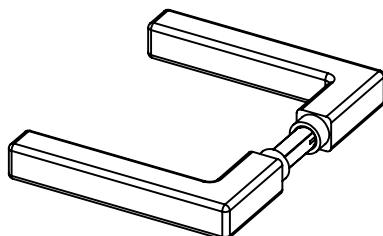

608W

- Maniglia sezione tonda angolo quadro. Quadro maniglia incluso.
- Manilla cuadrada. Cuadro manilla incluido.
- Rounded handle in a square shape. Internal mechanism included.
- Gehrungsdrücker mit rundem Griff und Vierkantstift.
- Poignée à section ronde à angles carrés. Cadre de poignée inclus.

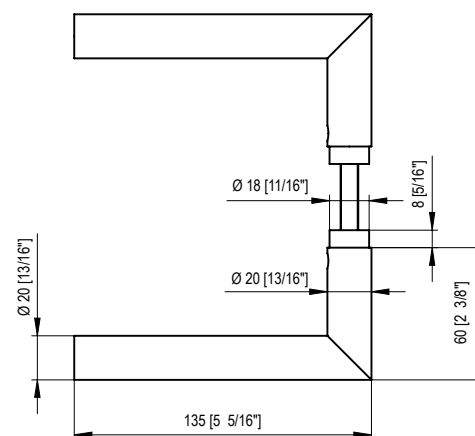
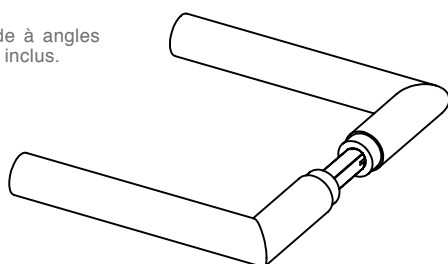

609W

• Maniglia sezione tonda angolo stondato. Quadro maniglia incluso.

• Manilla cuadrada. Cuadro manilla incluido.

• Rounded handle with rounded corner. Internal mechanism included.

• Rundformdrücker mit Vierkantstift.

• Poignée à section ronde à angles arrondis. Cadre de poignée inclus.

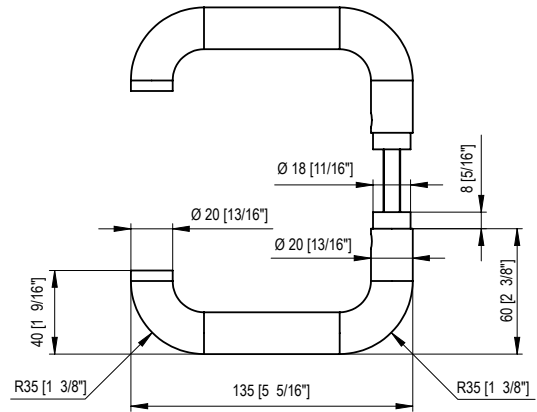
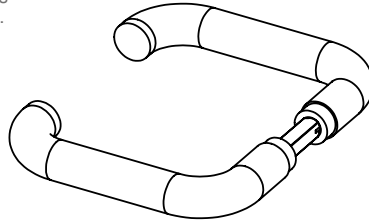

610W

• Maniglia impugnatura piatta. Quadro maniglia incluso.

• Manilla plana. Cuadro manilla incluido.

• Flat handgrip handle. Internal mechanism included.

• Gehrungsdrücker mit Flachformgriff und Vierkantstift.

• Poignée plate. Cadre de poignée inclus.

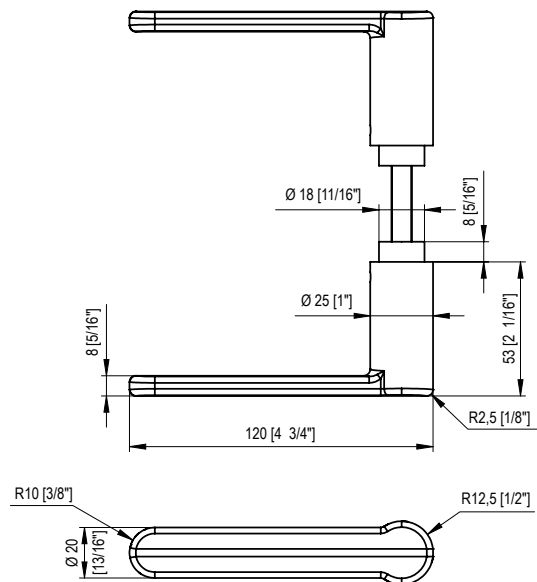
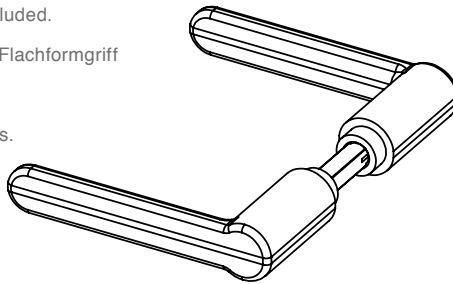



A69



- Catenacciolo con pomolino.
- Cerradillo con pomo pequeño.
- Locking bolt with small knob.
- Schubriegel mit kleinem Knopf.
- Loquet avec bouton.

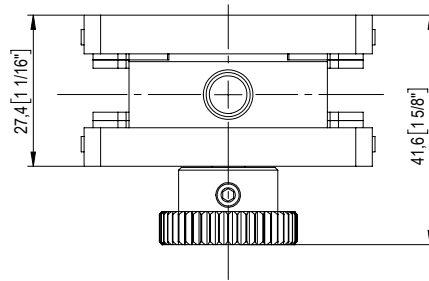
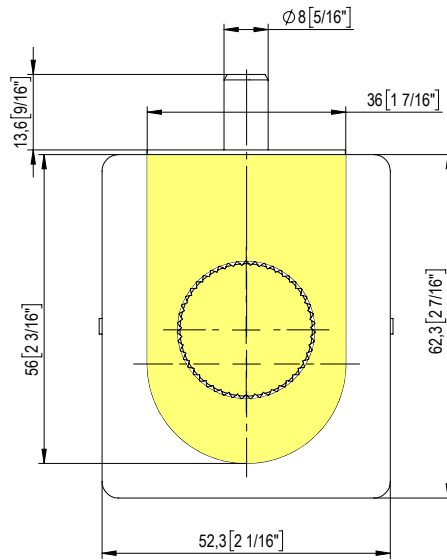
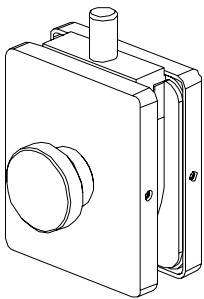

0160

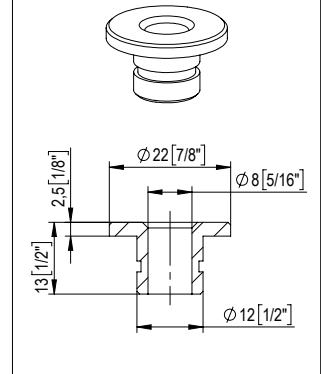

A695

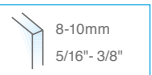

- Contro catenacciolo per art. A69.
- Contra cerradillo para art. A69.
- Lock keep bolt for A69.
- Gegenschubriegel für A69.
- Contre pêne pour art. A69.

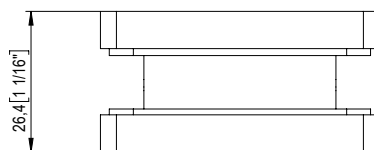
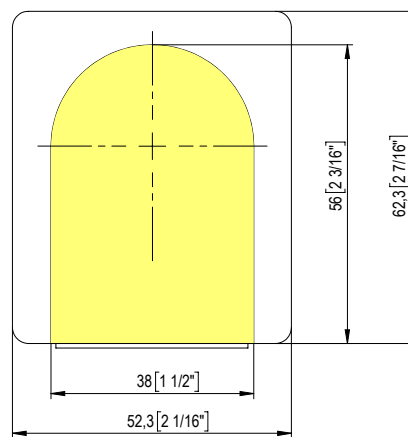
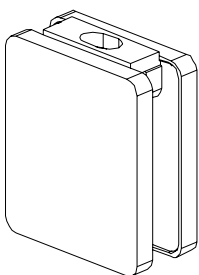

A86



- Catenacciolo con chiave.
- Cerradillo con llave.
- Locking bolt with key.
- Schübriegel mit Schlüssel.
- Loquet avec clé.

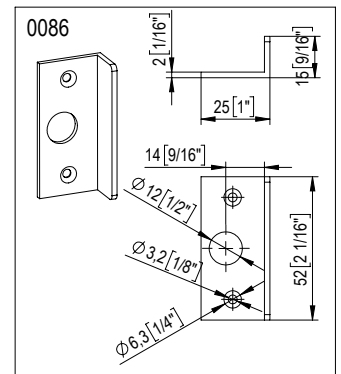
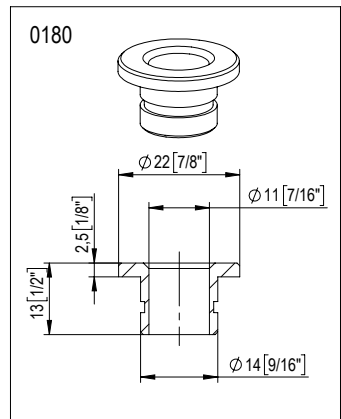
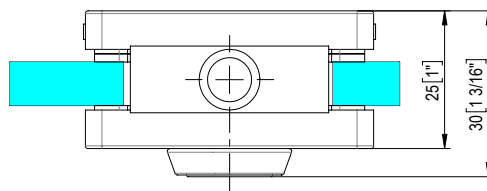
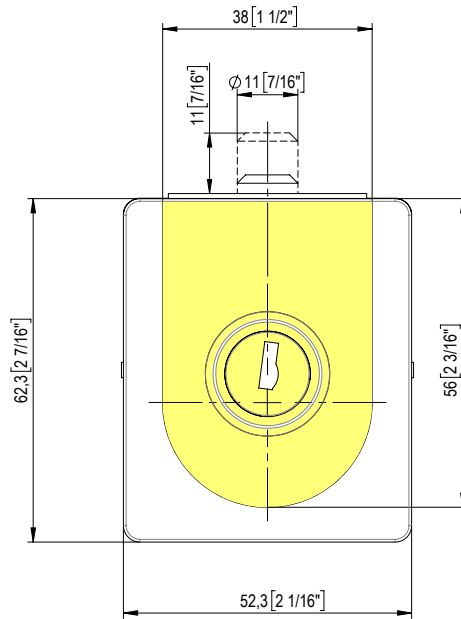
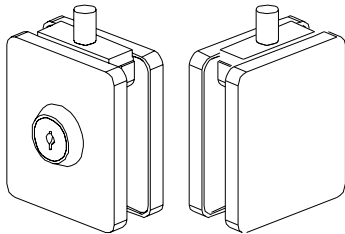

B19

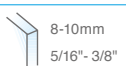

- Catenacciolo senza tacca nel vetro. Per vetro da 8-10mm. Per spessori diversi del vetro specificare.
- Cerradillo sin muesca en el vidrio. Para vidrio de 8-10 mm. Sobre pedido, para espesores diferentes de vidrio.
- Locking bolt without cut in the glass. For 8-10 mm. Different thickness on request.
- Schübriegel ohne Einschnitt im Glas. Für 8-10mm Glas. Unterschiedliche Dicke auf Wunsch.
- Loquet sans encoche dans le verre. Pour verre de 8-10mm. Préciser si différente épaisseur de verre.

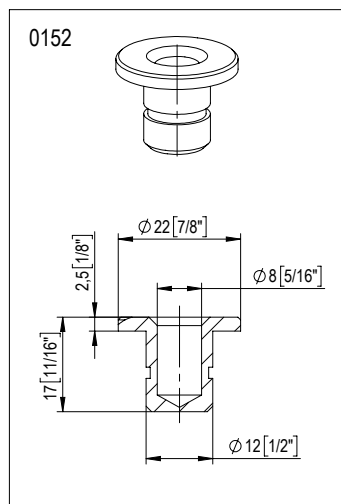
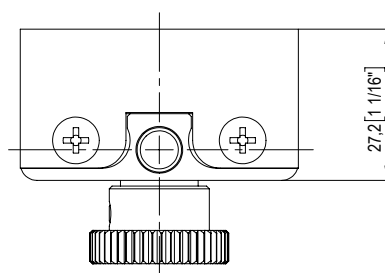
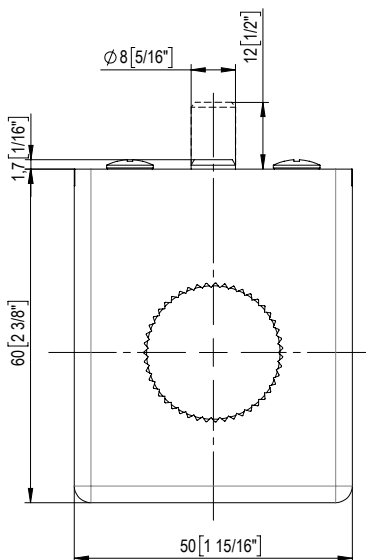
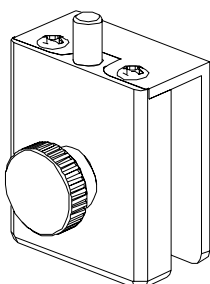

6M10(8-10mm) - 6M12(12mm)

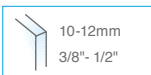

- Fermaporta magnetico h50mm.
- Freno magnético h50mm.
- Magnetic door stopper h50mm.
- Magnettürstopper h50mm.
- Fermeture magnétique h50mm.

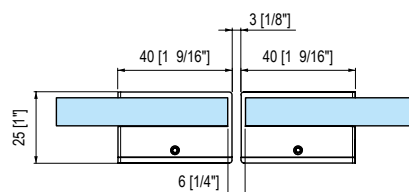
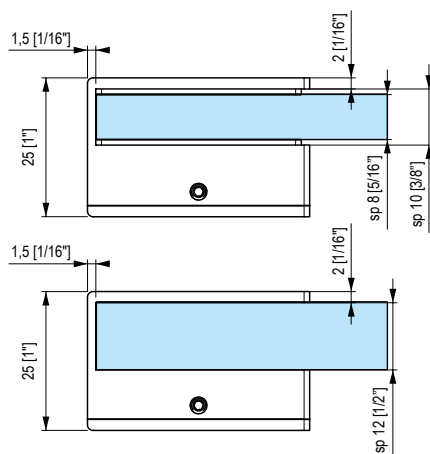
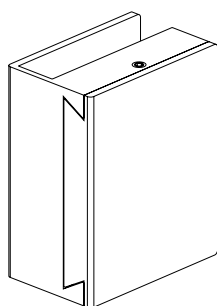
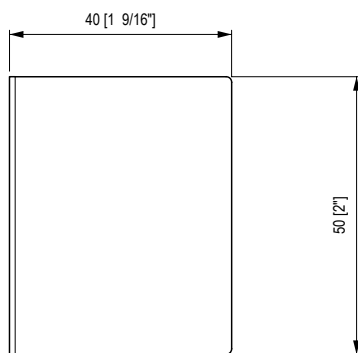

6M15

- Contropiastra magnetica per 6M10/6M12.
- Contra chapa magnética para 6M10/6M12.
- Magnetic plate for 6M10/6M12.
- Magnetische Gegenplatte für 6M10/6M12.
- Contreplaque magnétique pour 6M10/6M12.

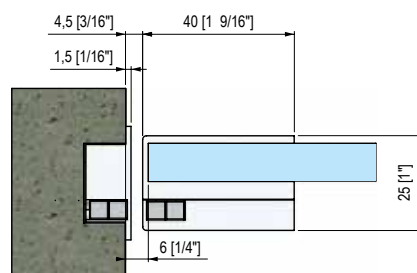
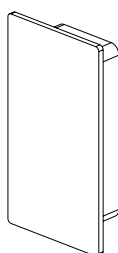
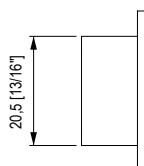
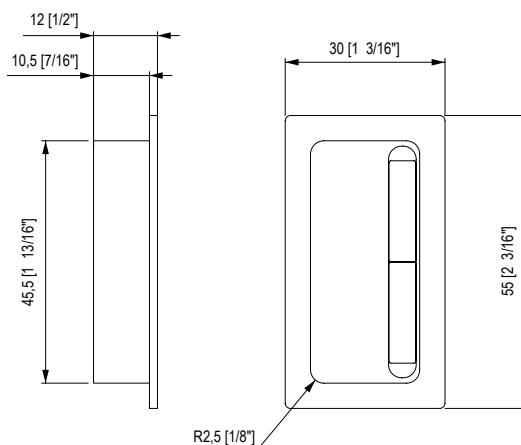

pomoli e maniglioni / knobs and handles

Alluminio / Aluminium



5006 finiture / colors 02-05
13-14-15-16-17-22-60-62

Legno / Wood



5006BT

Acciaio Inox / Stainless Steel



5H01 finiture / colors
31-32-60-62

Acciaio Inox / Stainless Steel

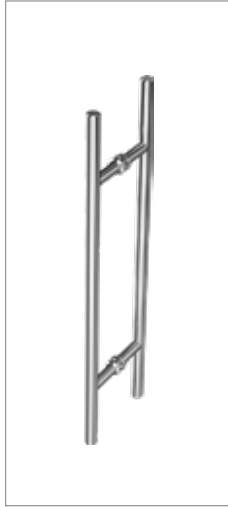

5H03 finiture / colors
31-32-60-62

Acciaio Inox / Stainless Steel

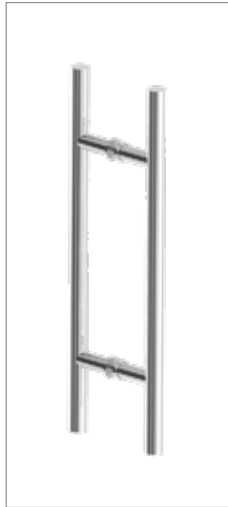

5H11 finiture / colors
31-32-60-62

Acciaio Inox / Stainless Steel

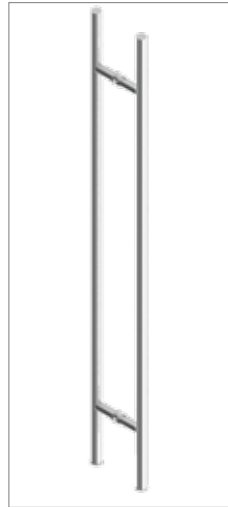

5H15 finiture / colors
31-32-60-62

Alluminio / Aluminium



5011 finiture / colors 02-05
13-14-15-16-17-22-60-62

Alluminio / Aluminium



5L01 finiture / colors
13-14-15-16-17-60-62

Acciaio Inox / Stainless Steel

Acciaio Inox / Stainless Steel

Acciaio Inox / Stainless Steel



500W50 finiture / colors
31-32

Acciaio Inox / Stainless Steel

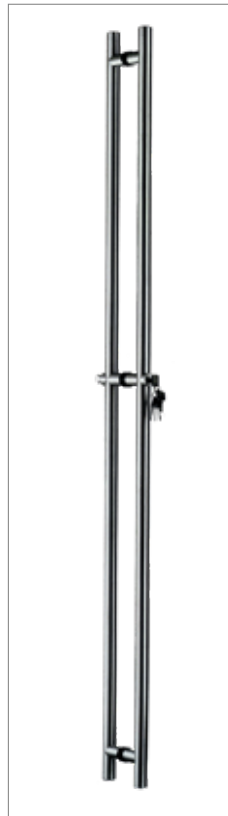

501W51 finiture / colors
31-32



5006

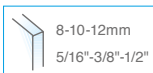

- Coppia pomoli diametro 60mm.
- Juego de pomos diámetro 60mm
- Pair of door knobs. Diameter 60mm.
- Paar Türknöpfe. Durchmesser 60mm.
- Couple de bouton diamètre 60mm.

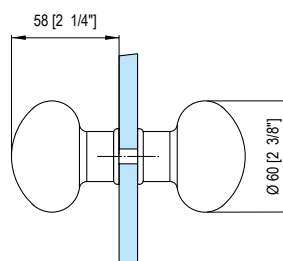
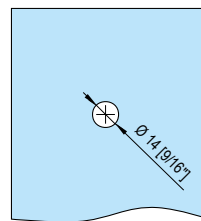
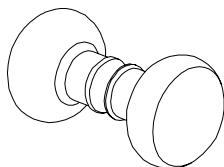

5006BT

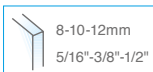

- Coppia pomoli in legno. Diametro 60mm.
- Juego de pomos en madera. Diámetro 60mm.
- Pair of wooden knobs. Diameter 60mm.
- Paar gerade Holzknöpfe. Durchmesser 60mm.
- Couple de bouton en ligne. Diamètre 60mm.

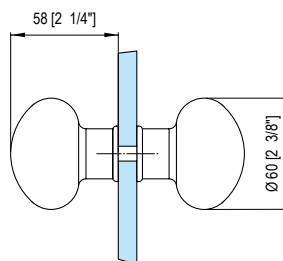
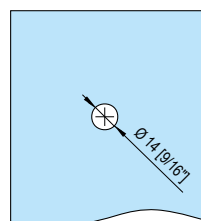
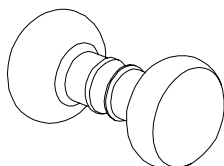

5H01



- Coppia maniglioni dritti. Interasse 192mm. Acciaio inox.
- Juego de tiradores. Distancia entre ejes 192mm. Acero.
- Pair of handles. Centre distance 192mm. Stainless steel.
- Paar gerade Türdrücker. Achsenabstand 192mm. Aus Edelstahl.
- Couple de poignées droites. Extraxe 192mm. Acier inox.

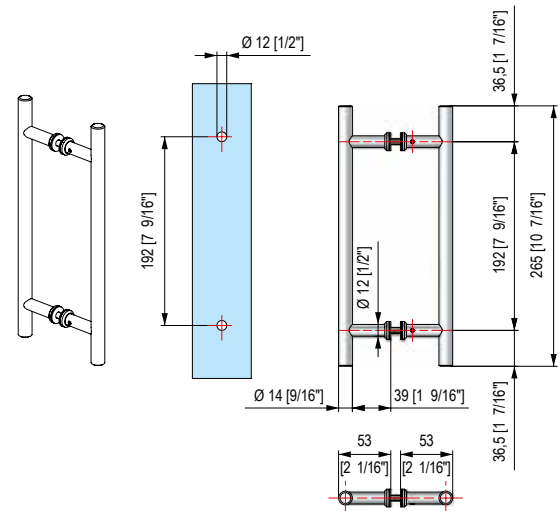

5H03



- Coppia maniglioni dritti. Interasse 250mm. Acciaio inox.
- Juego de tiradores. Distancia entre ejes 250mm. Acero.
- Pair of handles. Centre distance 250mm. Stainless steel.
- Paar gerade Türdrücker. Achsenabstand 250mm. Aus Edelstahl.
- Couple de poignées droites. Entraxe 250mm. Acier inox.

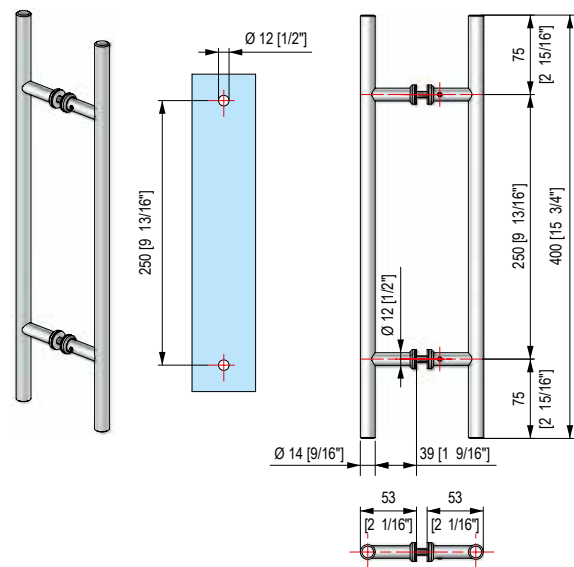

5H11



- Coppia maniglioni dritti. Interasse 300mm. Acciaio inox.
- Juego de tiradores. Distancia entre ejes 300mm. Acero.
- Pair of handles. Centre distance 300mm. Stainless steel.
- Paar gerade Türdrücker. Achsenabstand 300mm. Aus Edelstahl.
- Couple de poignées droites. Entraxe 300mm. Acier inox.

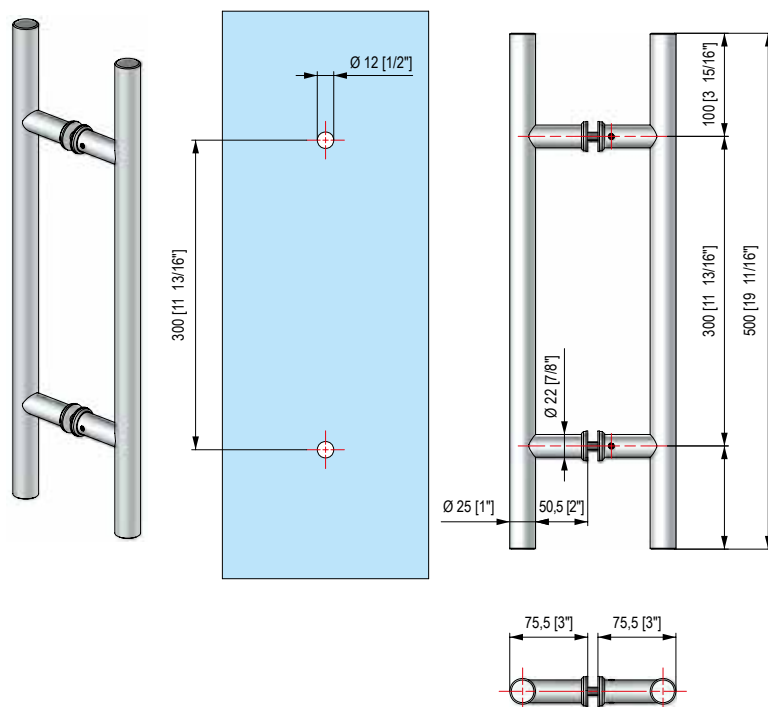

5H15

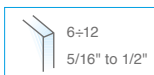

• Coppia maniglioni dritti. Interasse 900mm. Acciaio inox.

• Juego de tiradores. Distancia entre ejes 900mm. Acero.

• Pair of handles. Centre distance 900mm. Stainless steel.

• Paar gerade Türdrücker. Achsenabstand 900mm. Aus Edelstahl.

• Couple de poignées droites. Entraxe 900mm. Acier inox.

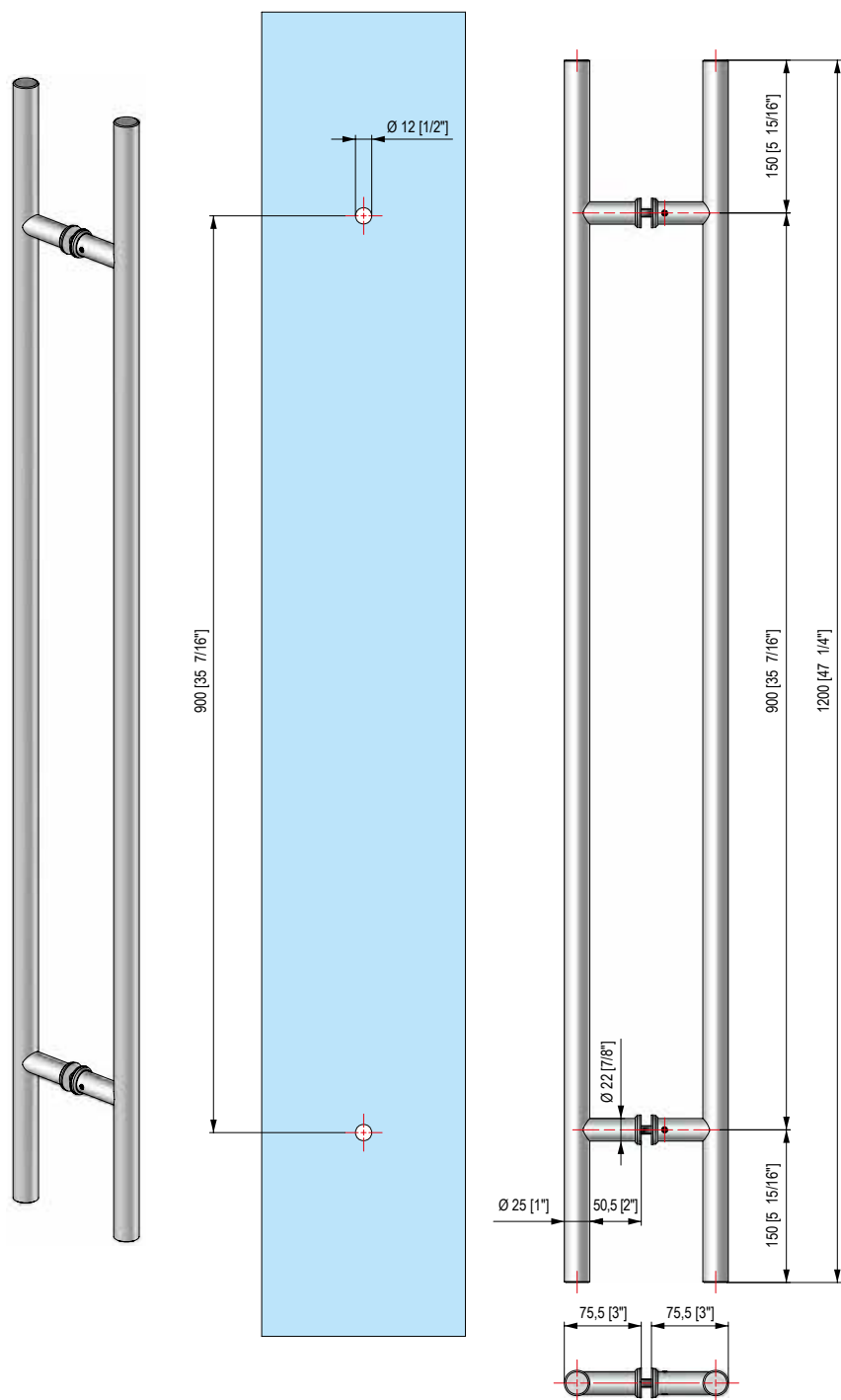

5011

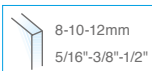

- Coppia maniglioni dritti.
Interasse 300mm.
- Juego de tiradores.
Distancia entre ejes 300mm.
- Pair of handles.
Centre distance 300mm.
- Paar gerade Türdrücker.
Achsenabstand 300mm.
- Couple de poignées droites.
Entraxe 300mm.

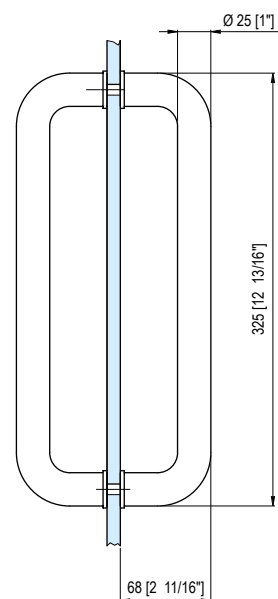
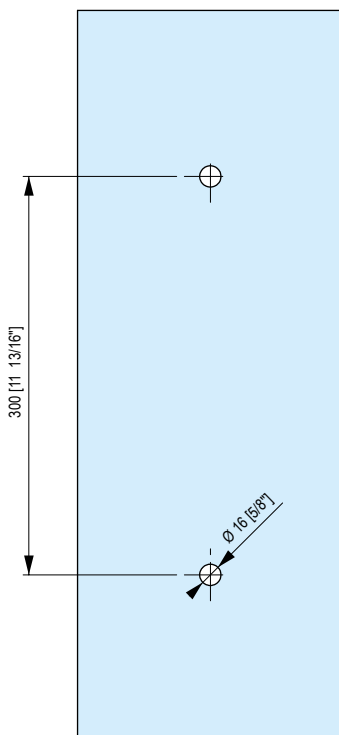
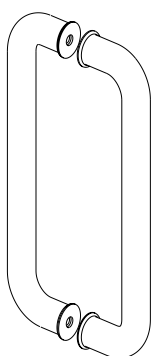

5L01

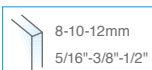

- Coppia maniglioni ad L.
Interasse 300 x 600 mm.
- Juego tirador y toallero.
Distancia entre ejes 300 x 600 mm.
- Pair of L-handles.
Centre distance 300 x 600 mm.
- Paar L-Türdrücker.
Achsenabstand 300 x 600 mm.
- Couple de poignées en L.
Entraxe 300 x 600 mm.

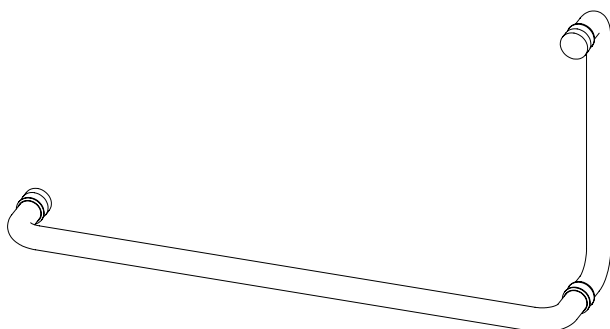
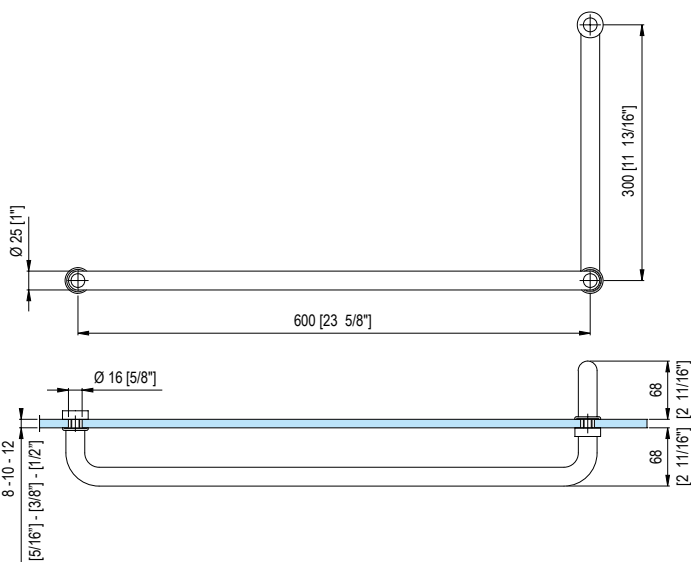

500W50



- Coppia di maniglioni $\varnothing 35$ mm. Acciaio inox. Serratura chiave-pomolo incorporata.
- Juego de tiradores $\varnothing 35$ mm. Acero inox. Cerradura llave-pomo incluida.
- Pair of handles $\varnothing 35$ mm. Stainless steel. Lock key-knob included.
- Paar Türdrücker $\varnothing 35$ mm. Edelstahl. Eingebautem Schloss, Schlüssel-Knopf.
- Couple de poignées $\varnothing 35$ mm. Acier inox. Serrure à bouton incorporée.

Serrature collegate e un punto di chiusura a pavimento

Cerraduras conectadas y un punto de cierre al suelo.

Connected locks and one closing point on the floor.

Verbundenes Schloß und ein Schließpunkt auf dem Boden.

Serrure connectée . Point de fermeture à palier.

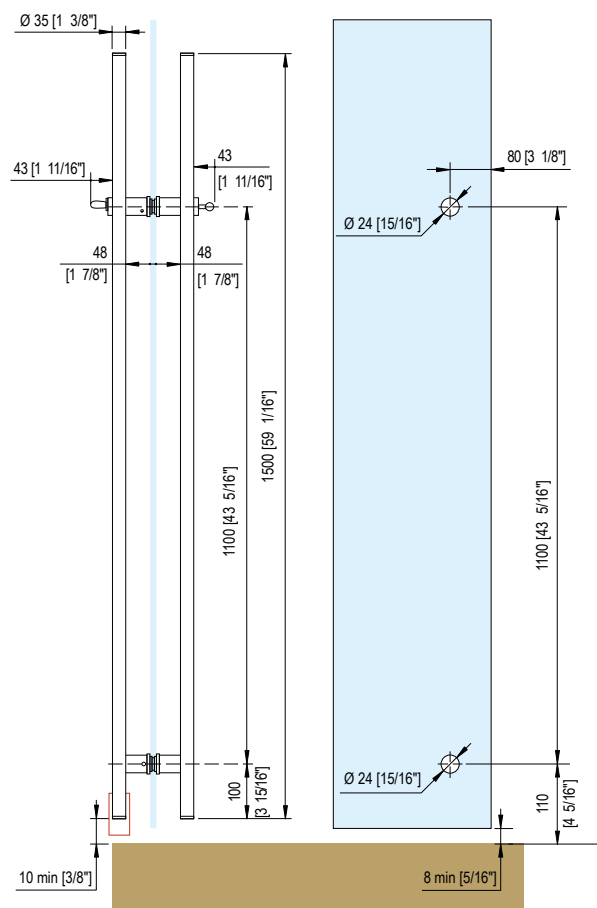
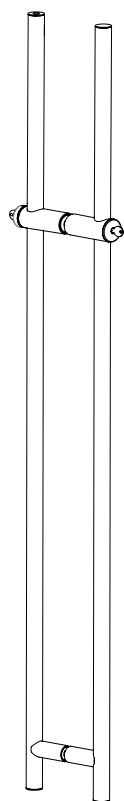
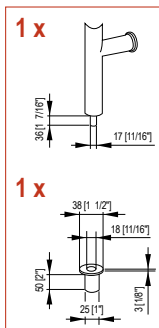

501W50



- Coppia di maniglioni $\varnothing 35\text{mm}$. Acciaio inox. Serratura chiave-pomolo incorporata.
- Juego de tiradores $\varnothing 35\text{mm}$. Acero inox. Cerradura llave-pomo incluida.
- Pair of handles $\varnothing 35\text{mm}$. Stainless steel. Lock key-knob included.
- Paar Türdrücker $\varnothing 35\text{mm}$. Edelstahl. Eingebautem Schloss, Schlüssel-Knopf.
- Couple de poignée $\varnothing 35\text{mm}$. Acier inox. Serrure à bouton incorporée.

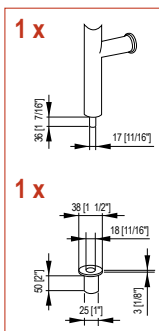

Serrature collegate e
un punto di chiusura a
pavimento

Cerraduras conectadas y
un punto de cierre al suelo.

Connected locks and one
closing point on the floor.

Verbundenes Schloß und
ein Schließpunkt auf dem
Boden.

Serrure connectée . Point
de fermeture à palier.

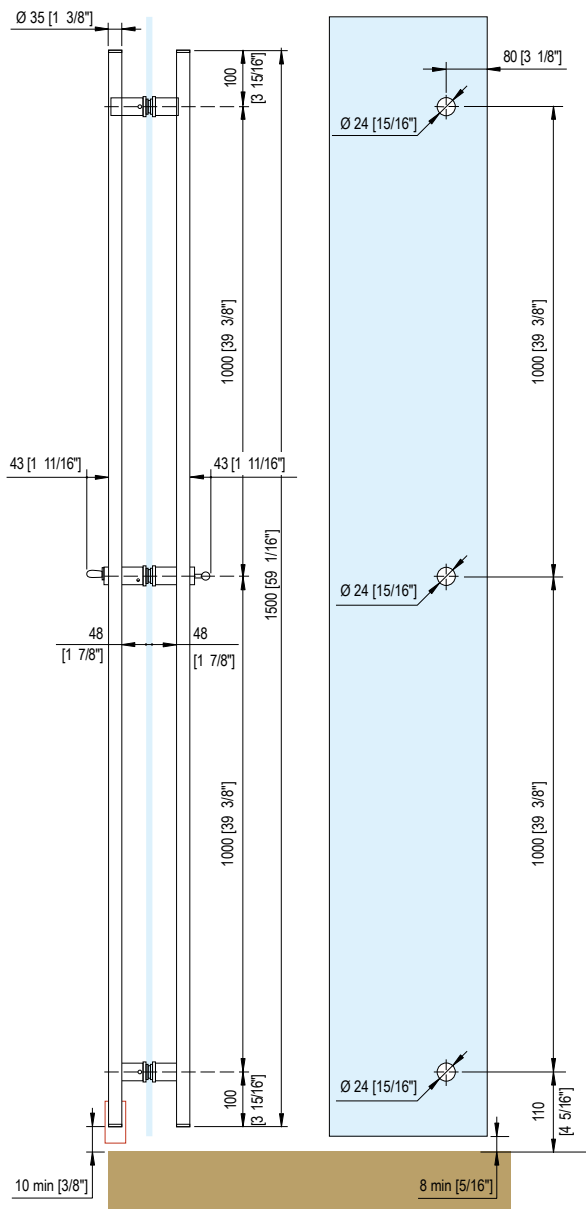
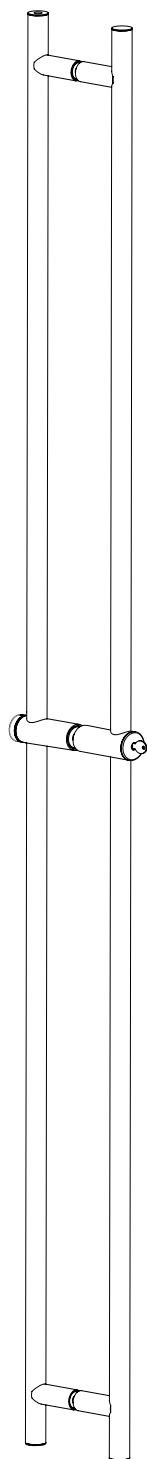





VETRINE

Escapartes
Cabinets
Vitrinen
Vitrines

vetrine / cabinets

Alluminio / Aluminium



B43 finiture / colors
13-14-15-16-17-40

Alluminio / Aluminium



B46 finiture / colors
13-14-15-16-17-40

Policarbonato / Polycarbonate



TQ10



TQ10

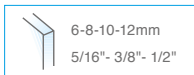

- Tassello sostegno ripiani.
Policarbonato (10PZ)
- Taco de soporte para rellanos.
Policarbonato (10PZ).
- Shelf support dowel
Polycarbonate.(10Pieces)
- Dübel für Regalstütze.
Polycarbonat (10Stuck).
- Cheville de support d'étagère.
Policarbonate (10 Pièces).

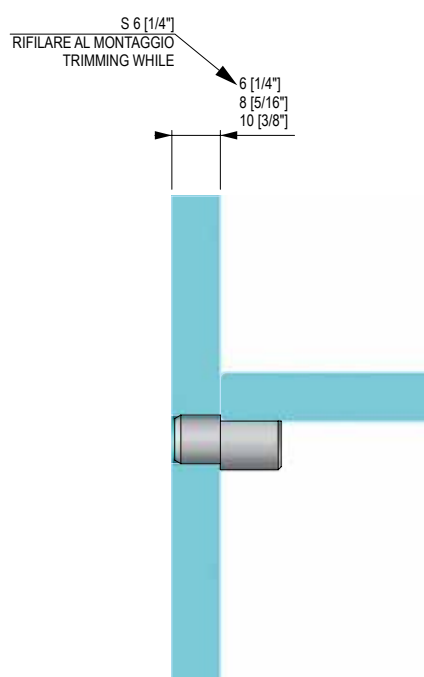
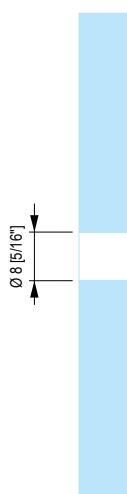
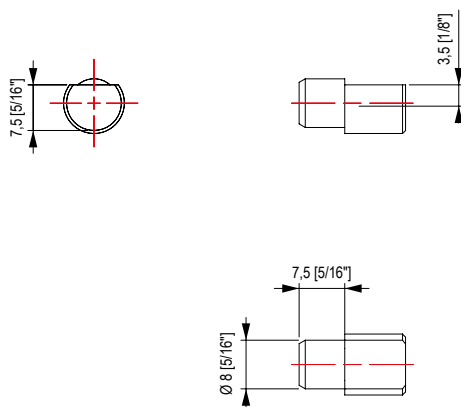
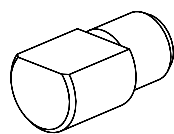

B43

B43R = destra - derecha - right - rechts - droite
 B43L = sinistra - izquierda - left - links - gauche

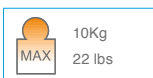
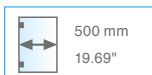

- Cernierina per vetro da 6 mm.
- Bisagra pequeña para vidrio de 6 mm.
- Small pivot patch for 6 mm. glass.
- Kleines Band für 6 mm. Glasdicke.
- Petite charnière pivot pour verre de 6 mm.

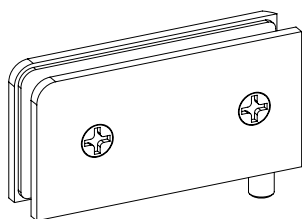
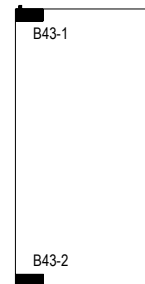
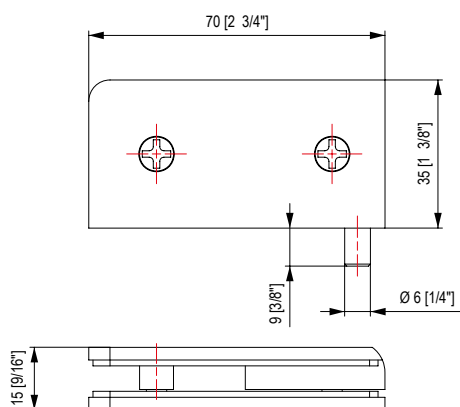

B43L

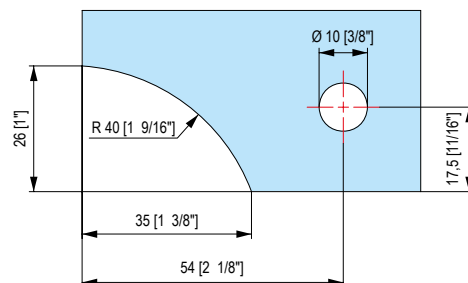

B46



- Serratura per vetro di 6-8mm. Una mandata.
- Cerradura para vidrio de 6-8mm.
- Lock for 6-8mm glass with single turn dead bolt.
- Schloss für 6-8mm Glas. Einmal Umdrehung.
- Serrure pour verre de 6-8mm. Un tour.

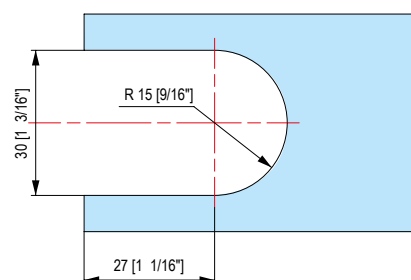
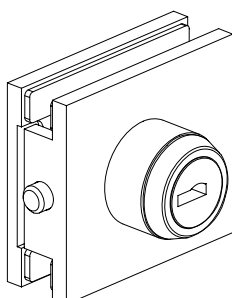
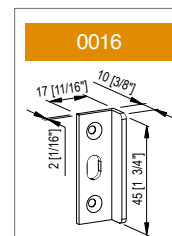
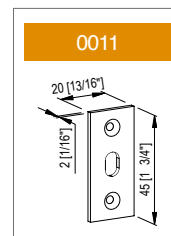
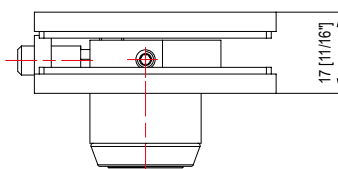
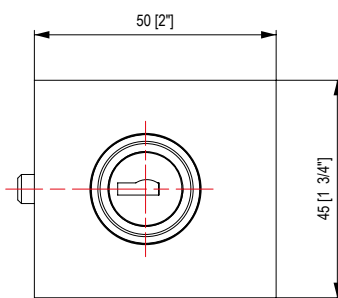

B53

B53R = destra - derecha - right - rechts - droite
B53L = sinistra - izquierda - left - links - gauche



- Cernierina per vetro da 8 mm.
- Bisagra pequeña para vidrio de 8 mm.
- Small pivot patch for 8 mm glass.
- Kleines Band für 8 mm Glasdicke.
- Petite charnière pivot pour verre de 8 mm.

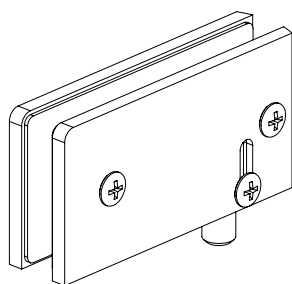
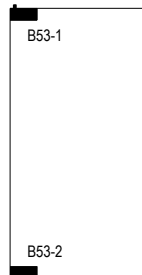
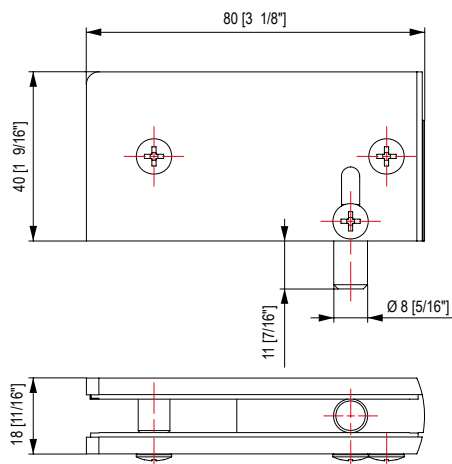

B53L

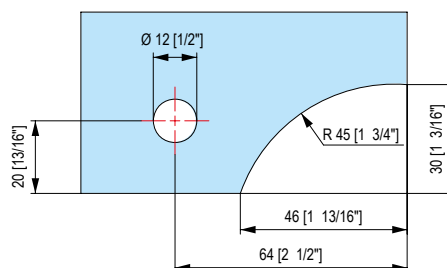





ARREDO URBANO

Mobiliario urbano
Urban Glass Fittings
Urbanes Design
Architecture Urbaine

balaustre / balustrade

Sabco



a pavimento / floor fixing
filo pavimento / built-in-slab



a muro / wall fixing



Alluminio / Aluminium - finiture / colors 02-13-RAL

SABCO, Sadev Balustrade Concept, è il sistema di balaustre in vetro senza telaio nelle versioni a muro, a pavimento e a filo pavimento. È particolarmente adatto per applicazioni pubbliche quali aeroporti, stadi, centri commerciali ed edifici. Massima trasparenza e alto grado di sicurezza. SABCO è stato progettato per soddisfare tutti i requisiti tecnici e di certificazione richiesti del mercato.

SABCO, Sadev Balustrade Concept, es el sistema de barandilla en vidrio sin marco – en modelo a pared, al suelo y coplanario al suelo. Es especialmente adecuado para aplicaciones públicas como aeropuertos, estadios, centros comerciales y edificios. Máxima la transparencia y alto el grado de seguridad. SABCO ha sido testado para cumplir con todos los requisitos técnicos y los requisitos de certificación del mercado.

SABCO, Sadev Balustrade Concept, is the system for frameless glass balustrade, available for wall, floor and built-in-slab mounting. It is particularly suitable for public applications such as airports, stadiums, shop-

ping centers and buildings. Maximum transparency and high level of security. SABCO has been tested to meet all technical and certification requirements of the market.

Das Balustraden Konzept SABCO von SADEV, ist ein rahmenloses System für Ganzglasgeländer und kann sowohl vorgefertigt wie auch aufgesetzt montiert werden. Das SABCO System ist besonders für den öffentlichen Bereich, wie z.B. Flughäfen, Stadien, Shopping-Center und Bürogebäuden geeignet. Höchster Maß an Transparenz und hohes Niveau an Sicherheit. SABCO wurde auf alle technischen Anforderungen des Marktes getestet.

Le SABCO by SADEV est un profil pour garde-corps en verre, disponible en application au sol, latérale et de fil de plancher. Il est particulièrement adapté aux applications publiques telles que les aéroports, les stades, centres commerciaux et bâtiments. Une transparence accrue et un haut niveau de sécurité. SABCO répond aux normes les plus strictes.





P21W 08



P21W 10



P21W 12



- Kit SABCO per balastra in vetro. Fissaggio a pavimento. L = 2,5m.
- SABCO kit de barandilla en vidrio. Ajuste al suelo. L = 2,5m.
- SABCO Kit for glass balustrade. Floor fixing. L = 2,5m.
- SABCO Set für Ganzglasgelande. Bodenbefestigung. L = 2,5m.
- SABCO Kit pour garde-corps en verre. Fixation au sol. L = 2,5 m

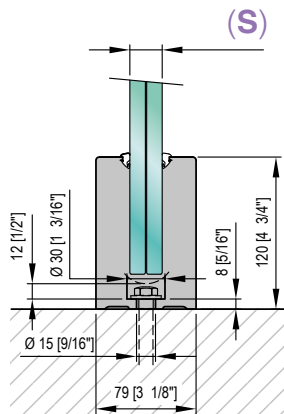

(S)

Per spessori vetri vedere tabella "Prestazioni e carichi".
 Para espesor del vidrio - ver el tablero "Prestación y carga".
 For glass thicknesses see table "Performance and loads".
 Für Glasdicken, siehe die Tabelle "Leistungsumfang und Belastung".
 Pour épaisseur du verre- regardez le tableau "Performances et charges".

Compresso / Included

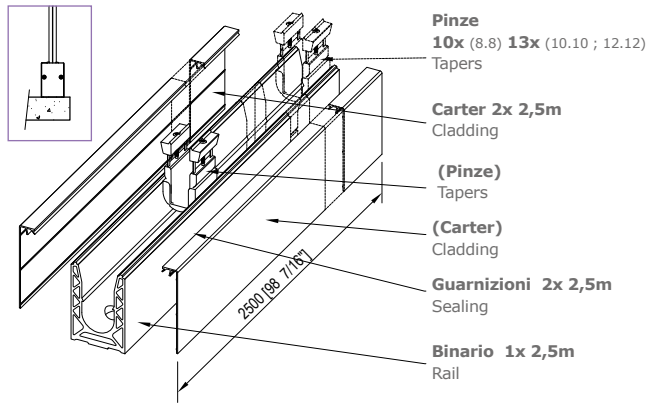

Binario e carter sono disponibili nella lunghezza di 5m solo su richiesta
 Binario y cárter - a petición - pueden ser de 5 mt
 Rail and cladding are available in length of 5m on demand only
 Schiene und Schutzprofil sind in der Länge von 5 Meter auf Anfrage verfügbar
 Binaire et carter sont disponibles dans la longueur de 5 m uniquement sur demande

Non compreso / Not included

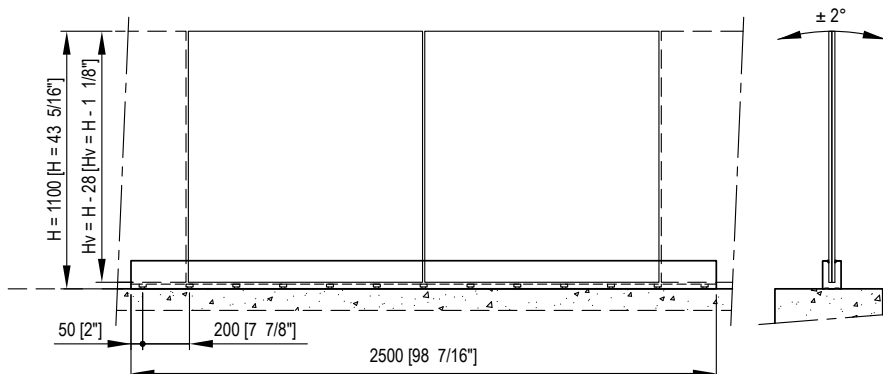
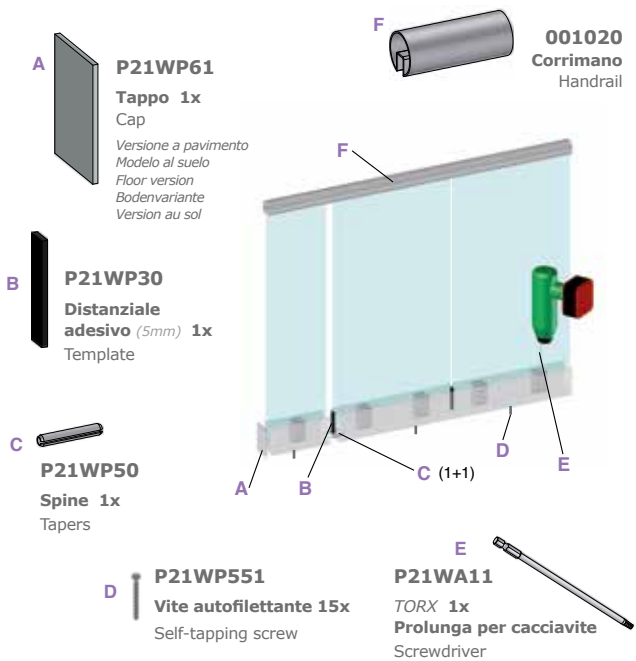

Prestazioni e carichi - Performance & loads

SABCO fissaggio a pavimento / floor fixing

Certificazione UNI 11678:2017				
	C1	C2	C3/C4/C5	
CARICO CARATTERISTICO SLE	1,0 kN/ml	2,0 kN/ml	3,0 kN/ml	
CARICO DI PROVA SLU	1,5 kN/ml	3,0 kN/ml	4,5 kN/ml	
IMPATTO CORPO SEMIRIGIDO - H CADUTA IMPATTATORE	700 mm	700 mm	1.200 mm	
N° BLOCCHETTI REGOLAZIONE	5/metro	5/metro	5/metro	
Vetro - Glass	8.8.4 Trosifol ES temperato / tempered	5/metro		
	8.8.4 DG41 temperato / tempered	5/metro		
	10.10.4 PVB indurito / hardened	5/metro		
	10.10.4 EVASAFE indurito / hardened	5/metro		
	10.10.4 SECURE indurito / hardened	5/metro		
	10.10.4 Trosifol ES temperato / tempered	5/metro	5/metro	5/metro
	10.10.4 DG41 temperato / tempered	5/metro	5/metro	5/metro
	10.10.4 EVASAFE temperato / tempered	5/metro	5/metro	
	10.10.4 SECURE temperato / tempered	5/metro	5/metro	
	10.10.4 SG temperato / tempered	5/metro	5/metro	5/metro
	12.12.4 Trosifol ES temperato / tempered	5/metro	5/metro	5/metro
	12.12.4 DG41 temperato / tempered	5/metro	5/metro	5/metro
	12.12.4 EVASAFE temperato / tempered	5/metro	5/metro	5/metro
	12.12.4 SECURE temperato / tempered	5/metro	5/metro	5/metro
	12.12.4 SG temperato / tempered	5/metro	5/metro	5/metro

NOTE:

I carichi e le categorie d'uso sono dedotti dalle "Norme Tecniche per le Costruzioni" 2018 Tab-3.1.II.

Le prove effettuate internamente e quelle effettuate presso l'Istituto Giordano sono state condotte secondo la norma: **UNI 11678:2017** - Vetro per l'edilizia - elementi di tamponamento in vetro aventi funzione anticaduta - Resistenza al carico statico lineare ed al carico dinamico - Metodi di Prova.

Il valore dell'altezza dal pavimento finito è pari a 1.100 mm.

NOTES:

Loads and use categories are extracted from "Norme tecniche per le Costruzioni" 2018 Tab- 3.1.II.

The internal tests, as well as the tests made at Istituto Giordano laboratories, were made according to the **UNI 11678:2017** regulation - Glass for building industry - Glass balustrades with antifall function - Resistance to static linear load and dynamic load - Testing methods.

The height from finished floor is 1.100 mm.

Prove eseguite IG
 I report di prova sono scaricabili dal sito

Test interni

Valutato non soddisfacente

	AVIS TECHNIQUE (FR 3034)			BRITISH STANDARD 6180			
	900 joules			No test required			
	0,6 to 1,8 kN	1 to 3 kN	1,7 to 5,1 kN	0,36 kN	0,74 kN	1,5 kN	3 kN
DYNAMIC TEST							
STATICAL LOAD	0,6 to 1,8 kN	1 to 3 kN	1,7 to 5,1 kN	0,36 kN	0,74 kN	1,5 kN	3 kN
HOLE FIXING DISTANCE	400 mm	400 mm	200 mm	400 mm	400 mm	400 mm	200 mm
Vetro - Glass	15 monolithic			4 w/m	4 w/m		
	8.8.2 PVB tempered	4 w/m		4 w/m			
	8.8.2 EVA tempered	4 w/m		4 w/m			
	8.8.2 Trosifol ES tempered	4 w/m	4 w/m		4 w/m	4 w/m	
	8.8.2 DG41 tempered	4 w/m	4 w/m		4 w/m	4 w/m	
	8.8.2 SGP tempered	4 w/m	4 w/m		4 w/m	4 w/m	
	10.10.4 PVB tempered	4 w/m	4 w/m		4 w/m	4 w/m	
	10.10.2 EVA tempered	4 w/m	4 w/m		4 w/m	4 w/m	4 w/m
	10.10.2 Trosifol ES tempered	4 w/m	4 w/m	5 w/m	4 w/m	4 w/m	4 w/m
	10.10.2 DG41 tempered	4 w/m	4 w/m	5 w/m	4 w/m	4 w/m	4 w/m
	19 monolithic				4 w/m	4 w/m	4 w/m
	10.10.2 SGP tempered	4 w/m	4 w/m	5 w/m	4 w/m	4 w/m	4 w/m
	10.10.2 SGP not tempered	5 w/m			4 w/m	4 w/m	
	12.12.2 SGP not tempered	5 w/m			4 w/m	4 w/m	4 w/m
	12.12.4 PVB tempered	4 w/m	4 w/m	5 w/m	4 w/m	4 w/m	4 w/m
12.12.2 EVA tempered	4 w/m	4 w/m	5 w/m	4 w/m	4 w/m	4 w/m	

Under Avis Technique.

AT Rated satisfactory.

Under British Standard.

BS Rated satisfactory.

Not rated satisfactory.

P22W 08



P22W 10



P22W 12



- Kit SABCO per balastra in vetro. Fissaggio a muro. L = 2,5m.
- SABCO kit de barandilla en vidrio. Ajuste a pared. L = 2,5m.
- SABCO Kit for glass balustrade. Wall fixing. L = 2,5m.
- SABCO Set für Ganzglasgeländer. Wandbefestigung. L = 2,5m.
- SABCO Kit pour garde-corps en verre. Fixation au mur. L = 2,5 m

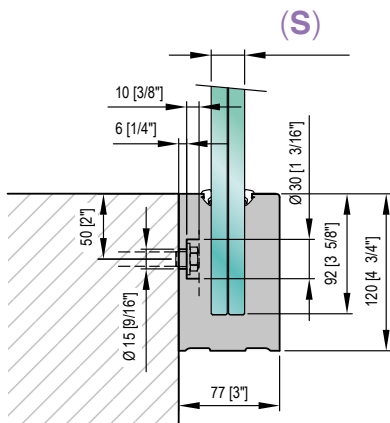

(S)

Per spessori vetri vedere tabella "Prestazioni e carichi".
 Para espesor del vidrio - ver el tablero "Prestación y carga".
 For glass thicknesses see table "Performance and loads".
 Für Glasdicken, siehe die Tabelle "Leistungsumfang und Belastung".
 Pour épaisseur du verre- regardez le tableau "Performances et charges".

Compresso / Included

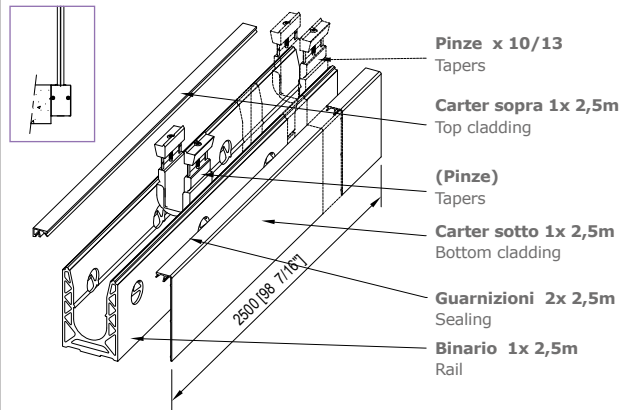

Binario e carter sono disponibili nella lunghezza di 5m solo su richiesta
 Binario y cárter - a petición - pueden ser de 5 mt
 Rail and cladding are available in length of 5m on demand only
 Schiene und Schutzprofil sind in der Länge von 5 Meter auf Anfrage verfügbar
 Binaire et carter sont disponibles dans la longueur de 5 m uniquement sur demande

Non compreso / Not included

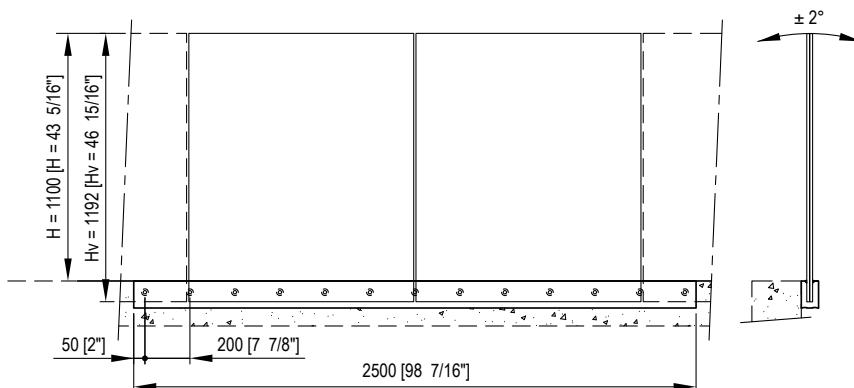
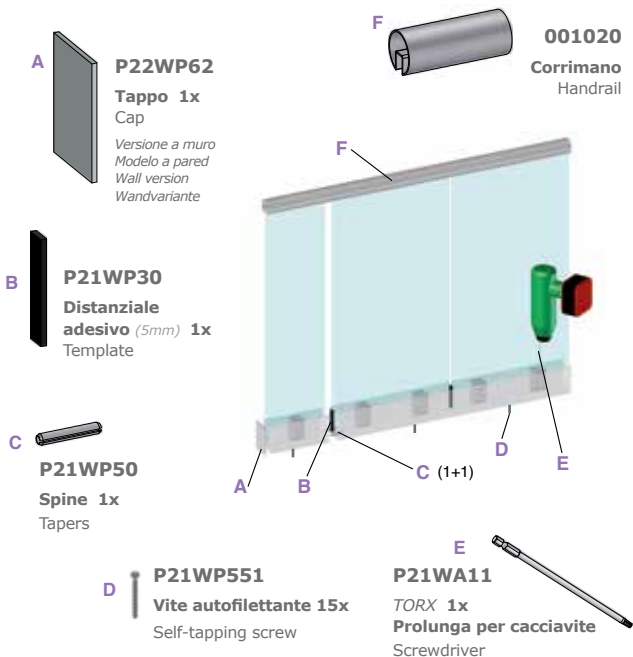

Prestazioni e carichi - Performance & loads

SABCO fissaggio a muro / wall fixing

		Certificazione UNI 11678:2017		
		C1	C2	C3/C4/C5
CARICO CARATTERISTICO SLE		1,0 kN/ml	2,0 kN/ml	3,0 kN/ml
CARICO DI PROVA SLU		1,5 kN/ml	3,0 kN/ml	4,5 kN/ml
IMPATTO CORPO SEMIRIGIDO - H CADUTA IMPATTATORE		700 mm	700 mm	1.200 mm
N° BLOCCHETTI REGOLAZIONE		5/metro	5/metro	5/metro
Vetro - Glass	8.8.4 Trosifol ES temperato / tempered	5/metro		
	8.8.4 DG41 temperato / tempered	5/metro		
	10.10.4 PVB indurito / hardened	5/metro		
	10.10.4 EVASAFE indurito / hardened	5/metro		
	10.10.4 SECURE indurito / hardened	5/metro		
	10.10.4 Trosifol ES temperato / tempered	5/metro	5/metro	
	10.10.4 DG41 temperato / tempered	5/metro	5/metro	
	10.10.4 EVASAFE temperato / tempered	5/metro	5/metro	
	10.10.4 SECURE temperato / tempered	5/metro	5/metro	
	10.10.4 SG temperato / tempered	5/metro	5/metro	
	12.12.4 Trosifol ES temperato / tempered	5/metro	5/metro	5/metro
	12.12.4 DG41 temperato / tempered	5/metro	5/metro	5/metro
	12.12.4 EVASAFE temperato / tempered	5/metro	5/metro	
	12.12.4 SECURE temperato / tempered	5/metro	5/metro	
	12.12.4 SG temperato / tempered	5/metro	5/metro	5/metro

NOTE:

I carichi e le categorie d'uso sono dedotti dalle "Norme Tecniche per le Costruzioni" 2018 Tab-3.1.II.

Le prove effettuate internamente e quelle effettuate presso l'Istituto Giordano sono state condotte secondo la norma: **UNI 11678:2017** - Vetro per l'edilizia - elementi di tamponamento in vetro aventi funzione anticaduta - Resistenza al carico statico lineare ed al carico dinamico - Metodi di Prova.

Il valore dell'altezza dal pavimento finito è pari a 1.100 mm.

NOTES:

Loads and use categories are extracted from "Norme tecniche per le Costruzioni" 2018 Tab- 3.1.II.

The internal tests, as well as the tests made at Istituto Giordano laboratories, were made according to the **UNI 11678:2017** regulation - Glass for building industry – Glass balustrades with antifall function – Resistance to static linear load and dynamic load – Testing methods.

The height from finished floor is 1.100 mm.

 Prove eseguite IG
I report di prova sono scaricabili dal sito

 Test interni

 Valutato non soddisfacente

		AVIS TECHNIQUE (FR 3034)			BRITISH STANDARD 6180		
		900 joules			No test required		
DYNAMIC TEST		0,6 to 1,8 kN	1 to 3 kN	1,7 to 5,1 kN	0,36 kN	0,74 kN	1,5 kN
STATIC LOAD							
HOLE FIXING DISTANCE		200 mm	200 mm	-	400 mm	400 mm	400 mm
Vetro - Glass	15 monolithic				4 w/m	4 w/m	
	8.8.2 PVB tempered				4 w/m		
	8.8.2 EVA tempered				4 w/m		
	8.8.2 Trosifol ES tempered	4 w/m	4 w/m		4 w/m	4 w/m	
	8.8.2 DG41 tempered	4 w/m	4 w/m		4 w/m	4 w/m	
	8.8.2 SGP	4 w/m	4 w/m		4 w/m	4 w/m	
	10.10.4 PVB tempered	4 w/m	4 w/m		4 w/m	4 w/m	
	10.10.2 EVA tempered	4 w/m	4 w/m		4 w/m	4 w/m	
	10.10.2 Trosifol ES tempered	4 w/m	4 w/m		4 w/m	4 w/m	4 w/m
	10.10.2 DG41 tempered	4 w/m	4 w/m		4 w/m	4 w/m	4 w/m
	19 monolithic				4 w/m	4 w/m	
	10.10.2 SGP tempered	4 w/m	4 w/m		4 w/m	4 w/m	4 w/m
	10.10.2 SGP not tempered				4 w/m	4 w/m	
	12.12.2 SGP not tempered	5 w/m			4 w/m	4 w/m	
	12.12.4 PVB tempered	4 w/m	4 w/m		4 w/m	4 w/m	4 w/m
12.12.2 EVA tempered	4 w/m	4 w/m		4 w/m	4 w/m	4 w/m	

 Under Avis Technique.

 AT Rated satisfactory.

 Under British Standard.

 BS Rated satisfactory.

 Not rated satisfactory.

P23W 08



P23W 10



P23W 12



- Kit SABCO per balastra in vetro. Fissaggio a filo pavimento. L = 2,5m.
- SABCO kit de barandilla en vidrio. Fijación coplanaria al suelo. L = 2,5m.
- SABCO Kit for glass balustrade. Built-in-slab. L = 2,5m.
- SABCO Set für Ganzglasgeländer. Bodenbefestigung. L = 2,5m.
- SABCO Kit pour garde-corps en verre. Fixation de fil de plancher. L = 2,5 m

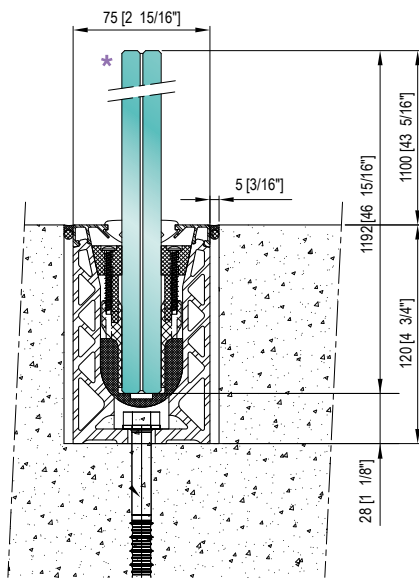

(S)*

Per spessori vetri vedere tabella "Prestazioni e carichi".
 Para espesor del vidrio - ver el tablero "Prestación y carga".
 For glass thicknesses see table "Performance and loads".
 Für Glasdicken, siehe die Tabelle "Leistungsumfang und Belastung".
 Pour épaisseur du verre- regardez le tableau "Performances et charges".

Compresso / Included

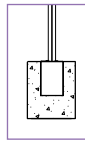

Carter 2x 2,5m
Cladding

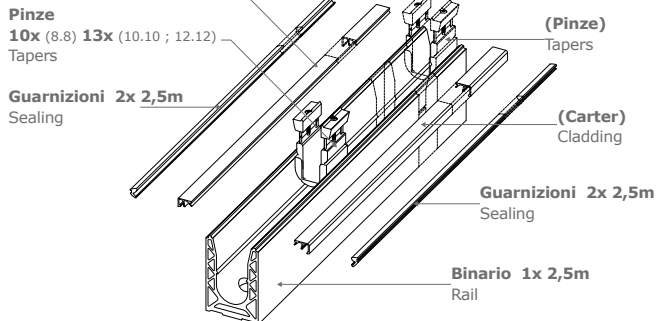

Binaro e carter sono disponibili nella lunghezza di 5m solo su richiesta
 Binaro y cárter - a petición - pueden ser de 5 mt
 Rail and cladding are available in length of 5 Meter auf Anfrage verfügbar
 Schiene und Schutzprofil sind in der Länge von 5 Meter auf Anfrage verfügbar
 Binaire et carter sont disponibles dans la longueur de 5 m uniquement sur demande

Non compreso / Not included

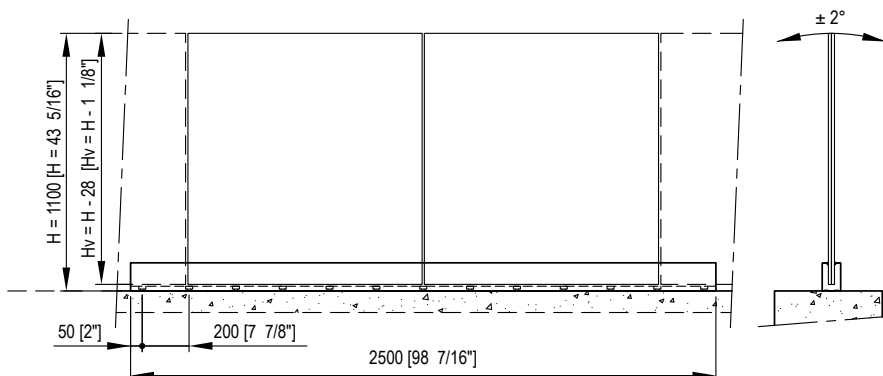
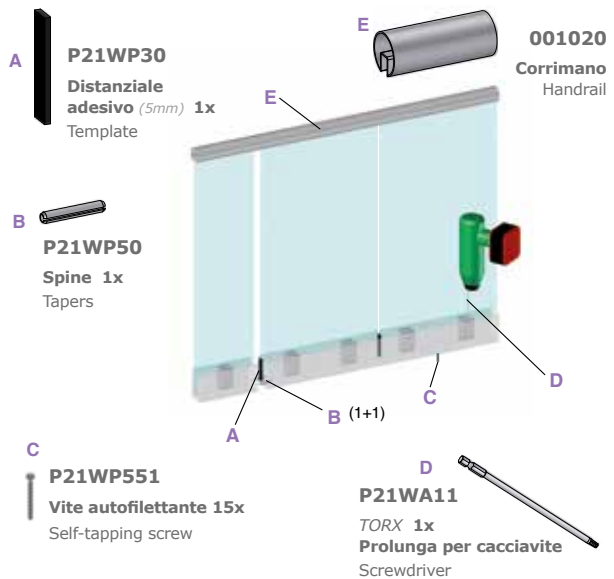

Prestazioni e carichi - Performance & loads

SABCO fissaggio a filo pavimento / built in slab

		AVIS TECHNIQUE (FR 3034)		BRITISH STANDARD 6180		
DYNAMIC TEST		900 joules		No test required		
STATIC LOAD		0,6 to 1,8 kN	1 to 3 kN	0,36 kN	0,74 kN	1,5 kN
HOLE FIXING DISTANCE		200 mm	200 mm	200 mm	200 mm	200 mm
Vetri - Glass	15 monolithic			4 w/m	4 w/m	
	8.8.2 PVB tempered			4 w/m		
	8.8.2 EVA tempered			4 w/m		
	8.8.2 Trosifol ES tempered	4 w/m	4 w/m	4 w/m	4 w/m	
	8.8.2 DG41 tempered	4 w/m	4 w/m	4 w/m	4 w/m	
	8.8.2 SGP	4 w/m	4 w/m	4 w/m	4 w/m	
	10.10.4 PVB tempered	4 w/m	4 w/m	4 w/m	4 w/m	
	10.10.2 EVA tempered	4 w/m	4 w/m	4 w/m	4 w/m	
	10.10.2 Trosifol ES tempered	4 w/m	4 w/m	4 w/m	4 w/m	4 w/m
	10.10.2 DG41 tempered	4 w/m	4 w/m	4 w/m	4 w/m	4 w/m
	19 monolithic			4 w/m	4 w/m	
	10.10.2 SGP tempered	4 w/m	4 w/m	4 w/m	4 w/m	4 w/m
	10.10.2 SGP not tempered			4 w/m	4 w/m	
	12.12.2 SGP not tempered	5 w/m		4 w/m	4 w/m	
	12.12.4 PVB tempered	4 w/m	4 w/m	4 w/m	4 w/m	4 w/m
	12.12.2 EVA tempered	4 w/m	4 w/m	4 w/m	4 w/m	4 w/m

Under Avis Technique.
 AT Rated satisfactory.
 Under British Standard.
 BS Rated satisfactory.
 Not rated satisfactory.

balaustre / balustrade

Flat



02 28 20 GD1



02 28 20 GD2



Acciaio Inox / Stainless Steel - finiture / colors 31

È un sistema di balaustre in vetro a piantana con regolazione del fissaggio del vetro inclusa. Può essere applicato in posizione orizzontale o verticale, adatto per applicazioni sia pubbliche che private. Semplice da installare è in acciaio inox e certificato CEBT.

Sistema de barandillas en vidrio con postes. Regulación de la fijación incluida. Aplicación vertical u horizontal, apto para aplicaciones públicas y privadas. Instalación simple. Sistema en acero inoxidable certificado CEBT.

Balustrade system with stainless steel posts, with glass adjustability. It can be installed vertically or horizontally, both in private and public environments. Easy installation, CEBT certified.

Es ist ein bodenstehendes Ganzglasgeländer mit Befestigungseinstellung des enthaltenen Glases. Es kann in einer horizontalen Position angewendet werden oder vertikal, geeignet für öffentliche und private Anwendungen. einfach zu installieren ist in Edelstahl und CEBT zertifiziert.

C'est un système de garde-corps économique avec réglage verre en place. Nombreux réglages possibles: horizontal / vertical. Installation facile, est en inox. PV CEBT à disposition.



02 28 20 GD1

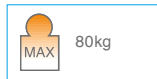

- Fissaggio semplice
- Ajuste simple.
- Simple fitting.
- Einfach Fixierung
- Fixation simple

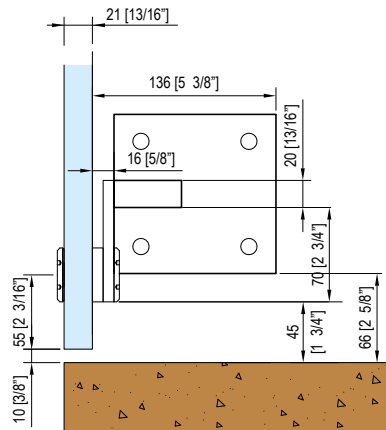

FORATURA - DRILLING

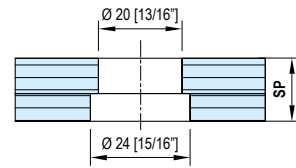

SP SPESSORE VETRO
GLASS THICKNESS

CODICE - CODE

13,52 ÷ 17,52 mm
17/32" to 11/16"

02 28 20 GD1 06 24 30*

19 ÷ 21,52 mm
3/4" to 27/32"

02 28 20 GD1 06 24 34

21,52 ÷ 25,52 mm
27/32" to 1"

02 28 20 GD1 06 24 38

*A4 for Stainless Steel 316

02 28 20 GD2



- Fissaggio doppio
- Ajuste doble
- Double fitting
- Doppelte Fixierung
- Fixation double

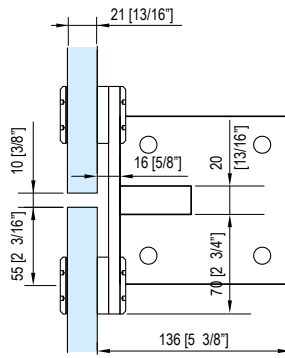

FORATURA - DRILLING

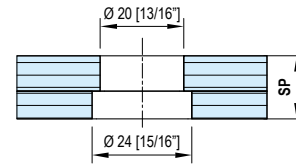

SP SPESSORE VETRO
GLASS THICKNESS

CODICE - CODE

13,52 ÷ 17,52 mm
17/32" to 11/16"

02 28 20 GD2 06 24 30*

19 ÷ 21,52 mm
3/4" to 27/32"

02 28 20 GD2 06 24 34

21,52 ÷ 25,52 mm
27/32" to 1"

02 28 20 GD2 06 24 38

*A4 for Stainless Steel 316

00 50 20 P1

- Balaustra a piantana
- Barandillas con postes
- Balustrade with stainless steel posts
- Bodenstehendes Ganzglasgelandär
- Garde-corps avec mât

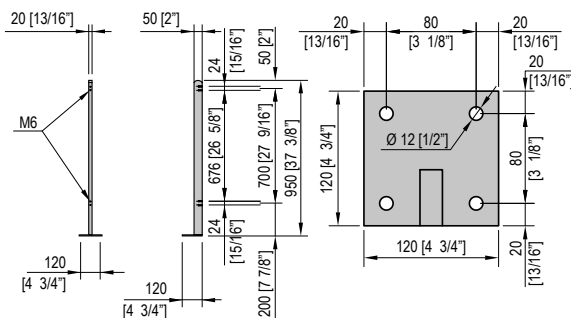

MATERIALE - MATERIAL

CODICE - CODE

Acciaio personalizzabile
Steel ready to paint

00 50 20 P1-AC

Acciaio Inox 304
Stainless Steel 304

00 50 20 P1-IN304

Acciaio Inox 316
Stainless Steel 316

00 50 20 P1-IN316

Plate on slab nose on request

02 29 21

90°



- Angolare fisso 90° muro/vetro
- Angolar fijo 90° pared-vidrio
- Fixed angular at 90° wall to glass
- Festes Winkelprofil 90° Wand-Glas
- Renvoi d'angle fixe 90°mur/verre

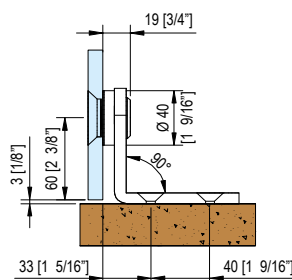

FORATURA - DRILLING

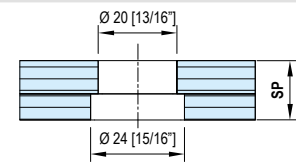

SP SPESSORE VETRO
GLASS THICKNESS

CODICE - CODE

13,52 ÷ 17,52 mm
17/32" to 11/16"

02 29 21 06 24 30

19 ÷ 21,52 mm
3/4" to 27/32"

02 29 21 06 24 34

21,52 ÷ 25,52 mm
27/32" to 1"

02 29 21 06 24 38

00 10 20

5m.

- Corrimano in acciaio inox.
- Pasamano en acero satinado.
- Handrail made of satin Stainless-steel.
- Handlauf aus satiniertem Edelstahl.
- Main courante en inox.

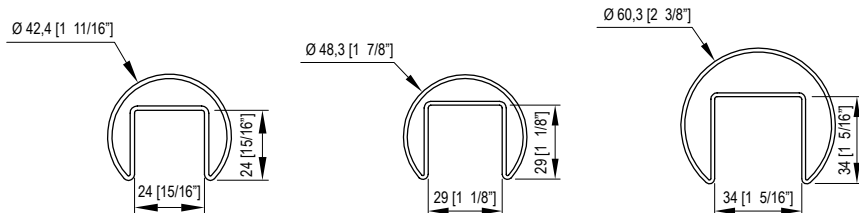

Ø	MATERIALE - MATERIAL	CODICE - CODE
42,4 mm 1 11/16"	Acciaio Inox 304 - Stainless Steel 304	00 10 20 42 500
	Acciaio Inox 316 - Stainless Steel 316	00 10 20 42 500 A4
48,3 mm 1 7/8"	Acciaio Inox 304 - Stainless Steel 304	00 10 20 48 500
	Acciaio Inox 316 - Stainless Steel 316	00 10 20 48 500 A4
60,3 mm 2 3/8"	Acciaio Inox 304 - Stainless Steel 304	00 10 20 60 500
	Acciaio Inox 316 - Stainless Steel 316	00 10 20 60 500 A4

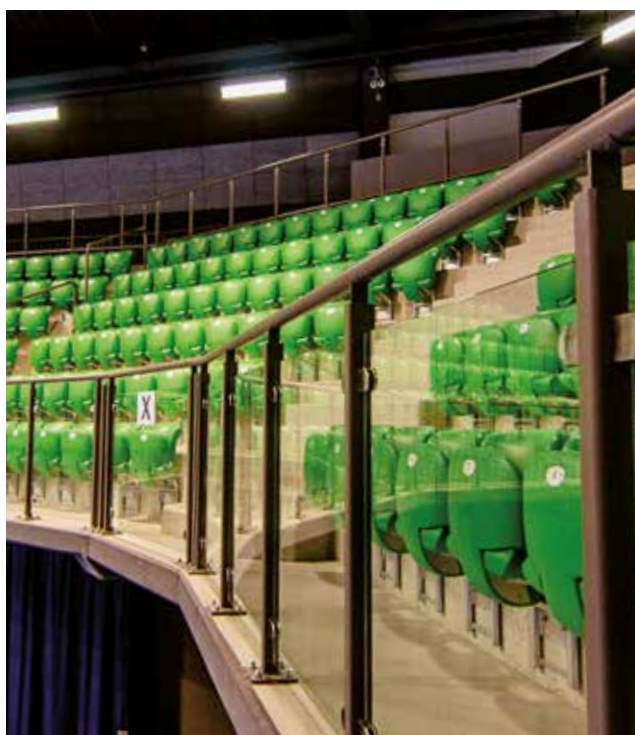

Non compreso / Not included



- Guarnizione
- Herraje
- Gasket
- Dichtung
- Joints

Ø	SPESSORE VETRO - GLASS THICKNESS	CODICE - CODE
42,4 mm 1 1/16"	10 > 13,5 mm 3/8" > 17/32"	00 10 24 10 135
	15 > 17,5 mm 19/32" > 11/16"	00 10 24 15 175
	19 > 21,5 mm 3/4" > 27/32"	00 10 24 19 215
48,3 mm 1 7/8"	10 > 13,5 mm 3/8" > 17/32"	00 10 29 10 135
	15 > 17,5 mm 19/32" > 11/16"	00 10 29 15 175
	19 > 21,5 mm 3/4" > 27/32"	00 10 29 19 215
	21,5 > 25,5 mm 27/32" > 1"	00 10 29 21 255
60,3 mm 2 3/8"	15 > 17,5 mm 19/32" > 11/16"	00 10 34 15 175
	19 > 21,5 mm 3/4" > 27/32"	00 10 34 19 215
	19 > 25,5 mm 3/4" > 1"	00 10 34 21 255



- Tappo di chiusura
- Tapón por el "cierre"
- End cap
- Schließstopfen
- Bouchons

Ø	MATERIALE - MATERIAL	CODICE - CODE
42,4 mm 1 1/16"	Acciaio Inox 304 - Stainless Steel 304	00 10 20 42 10
	Acciaio Inox 316 - Stainless Steel 316	00 10 20 42 10 A4
48,3 mm 1 7/8"	Acciaio Inox 304 - Stainless Steel 304	00 10 20 48 10
	Acciaio Inox 316 - Stainless Steel 316	00 10 20 48 10 A4
60,3 mm 2 3/8"	Acciaio Inox 304 - Stainless Steel 304	00 10 20 60 10
	Acciaio Inox 316 - Stainless Steel 316	00 10 20 60 10 A4



- Connettore 90°
- Conectador 90°
- 90° connector
- Verbindung 90°
- Connecteur 90°

Ø	MATERIALE - MATERIAL	CODICE - CODE
42,4 mm 1 1/16"	Acciaio Inox 304 - Stainless Steel 304	00 10 20 42 29
	Acciaio Inox 316 - Stainless Steel 316	00 10 20 42 29 A4
48,3 mm 1 7/8"	Acciaio Inox 304 - Stainless Steel 304	00 10 20 48 29
	Acciaio Inox 316 - Stainless Steel 316	00 10 20 48 29 A4
60,3 mm 2 3/8"	Acciaio Inox 304 - Stainless Steel 304	00 10 20 60 29
	Acciaio Inox 316 - Stainless Steel 316	00 10 20 60 29 A4



- Connettore 180°
- Conectador 180°
- 180° connector
- Verbindung 180°
- Connecteur 180°

Ø	MATERIALE - MATERIAL	CODICE - CODE
42,4 mm 1 1/16"	Acciaio Inox 304 - Stainless Steel 304	00 10 20 42 20
	Acciaio Inox 316 - Stainless Steel 316	00 10 20 42 20 A4
48,3 mm 1 7/8"	Acciaio Inox 304 - Stainless Steel 304	00 10 20 48 20
	Acciaio Inox 316 - Stainless Steel 316	00 10 20 48 20 A4
60,3 mm 2 3/8"	Acciaio Inox 304 - Stainless Steel 304	00 10 20 60 20
	Acciaio Inox 316 - Stainless Steel 316	00 10 20 60 20 A4

pensiline / cantilever roof

Pensile

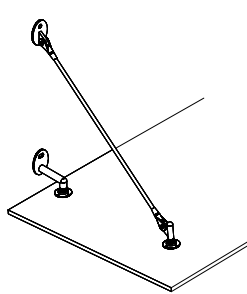

PS00

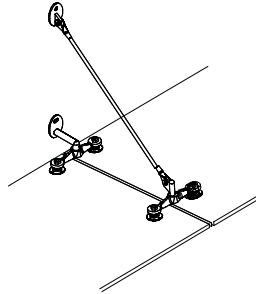

PS05

Alluminio / Aluminium - finiture / colors 31

Le pensiline in vetro, come è noto, conferiscono alle facciate degli edifici un tocco di classe e di modernità. Esistono sostanzialmente due kit, i quali combinati fra loro consentono diverse soluzioni, monolastra o multilastra. Richieste particolari per dimensione o portata, possono essere comunque calcolate e supportate dal nostro ufficio tecnico.

Es notorio que la marquesina en vidrio, confiere un aspecto de clase y modernidad. Dos son los kit que se pueden combinar en diferentes soluciones, lámina simple o múltipla. Diferentes tamanos o acabados, podrían ser solucionados de nuestra oficina tecnica.

The glass canopies, as it is well known, give the buildings' facades a touch of class and modernity. There are basically 2 sets, which allow different solutions that may be single or multiple plate. Special requests

concerning dimensions or capacity may be calculated and supported by our technical department.

Glasvordächer verleihen Gebäudefassaden Klasse und Modernität. Es gibt drei verschiedene Sätze, die immer die richtige Lösung bieten. Zwei Bausätze stehen zur Verfügung, die miteinander kombiniert, multiple Ausführungsmöglichkeiten bieten. Sonderlösungen können auf Anfrage von unserer Technikabteilung berechnet und geplant werden.

Les marquises en verre offrent une touche de modernité aux façades des bâtiments. Il existe 2 solutions, qui permettent de mettre en oeuvre un ou plusieurs verres. Les marquises aux dimensions spéciales nécessitent un calcul réalisé par notre bureau d'études.



PS00

- Kit pensilina attacco singolo.
- Kit marquesina. 1 punto de fijación
- Canopy kit. 1 fixing point.
- Kit Glasvordächer einzelner Angriff.
- Kit de marquises coulot simple.

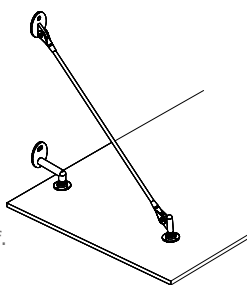

La lunghezza β del tirante (v1, v2, v3, v4, v5) è in funzione di B. Vedi tabella.

El largo del tirante β (v1, v2, v3, v4, v5) depende de B. Mira a la tablilla.

The pulling cable length β (v1, v2, v3, v4, v5) is in function of B. See the schedule.

Die Länge der Anzugstange β (v1; v2; v3; v4; v5) ist in funktion von B. Tabelle sehen.

La longueur β du tirant (v1, v2, v3, v4, v5) c'est en fonction de B. Voir tableau

Compreso - Included



PS05

- Kit pensilina attacco doppio.
- Kit marquesina. Fijación doble.
- Canopy kit. Double fixing fitting.
- Kit Glasvordächer doppelangriff.
- Kit de marquises coulot double.

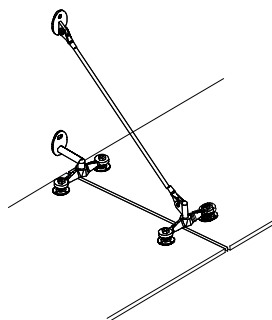

La lunghezza β del tirante (v1, v2, v3, v4, v5) è in funzione di B. Vedi tabella.

El largo del tirante β (v1, v2, v3, v4, v5) depende de B. Mira a la tablilla.

The pulling cable length β (v1, v2, v3, v4, v5) is in function of B. See the schedule.

Die Länge der Anzugstange β (v1; v2; v3; v4; v5) ist in funktion von B. Tabelle sehen.

La longueur β du tirant (v1, v2, v3, v4, v5) c'est en fonction de B. Voir tableau

Compreso - Included

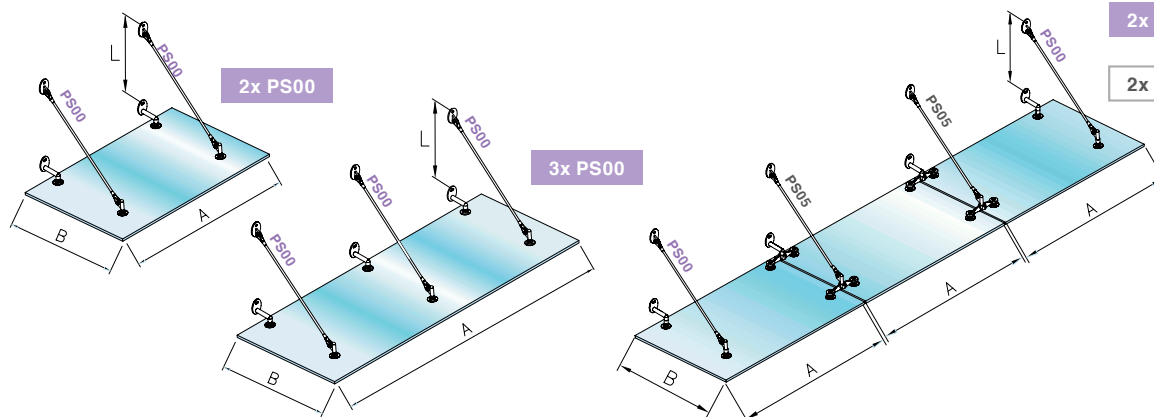

Creazione codice del tirante in base alla quota B
 Creating code of the tie rod according to the share B

QUOTE DI DIMENSIONAMENTO - QUOTE SIZING (dimensioni in mm - dimensions in mm)

B	CODICE CODIGO CODE KODE		A		Angolo di inclinazione		Spessore del vetro Glass thickness		
	Identificativo identification number	β	4 Punti fissaggio	6 Punti fissaggio	-5°	+5°			
800-1000	PS40	V1	1000-1800	1800-2800	PA	PB	L	L	
1001-1150		V2					600	610	720
1151-1300		V3					800	792	936
1301-1500		V4					900	883	1045
1501-1700		V5					1100	1065	1260
					1300	1247	1478		
					1300 MAX				
							6+6+1.52 PA < 800		
							8+8+1.52 800 < PA < 1100		
							10+10+1.52 1100 < PA < 1300		

Vetro singolo - Single glass

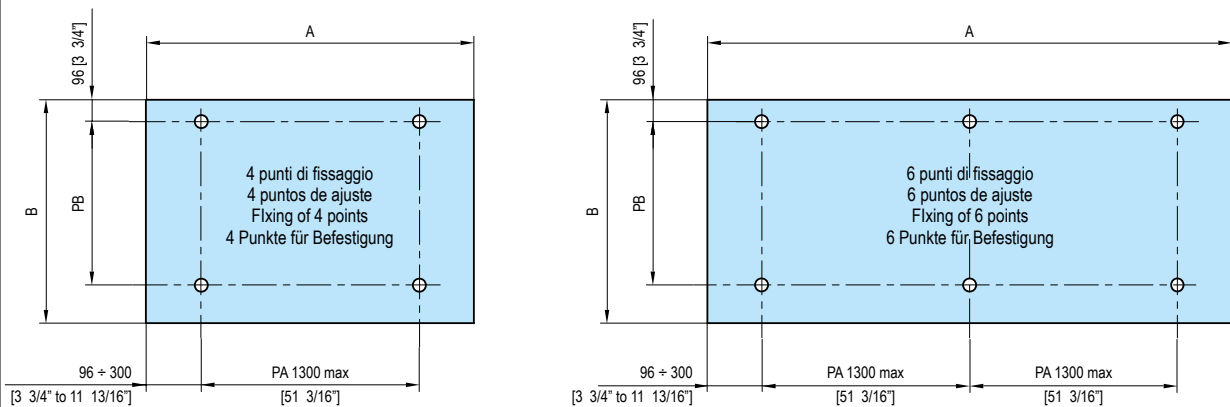

Vetro multiplo - Multiple glass

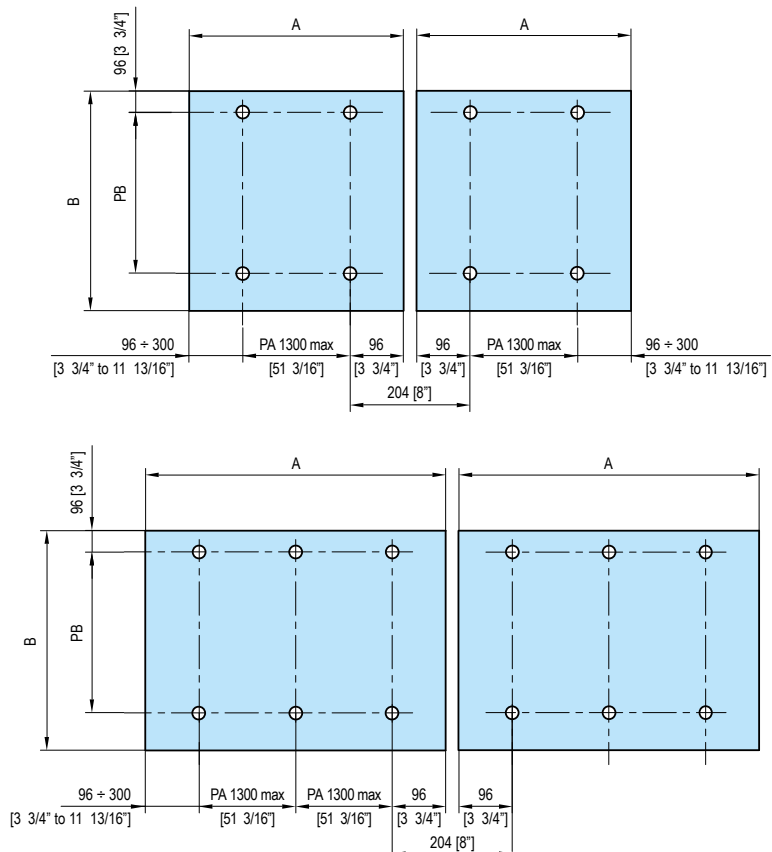

+5°

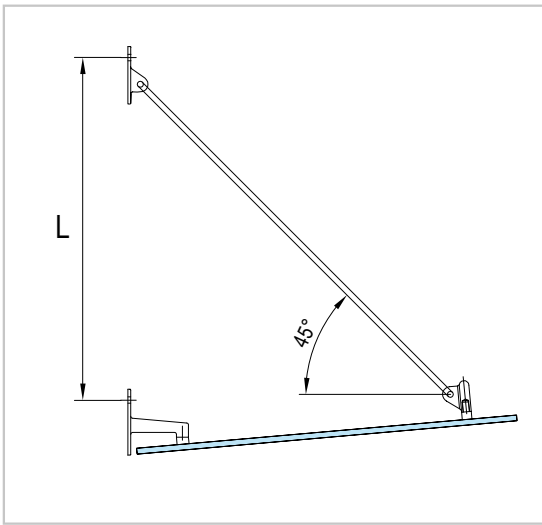

-5°

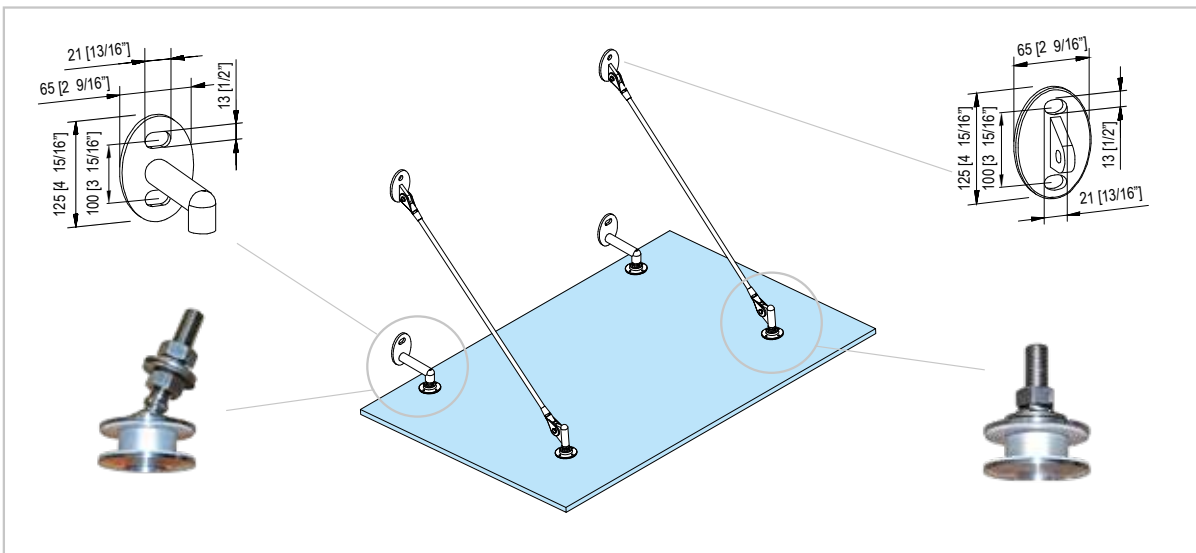
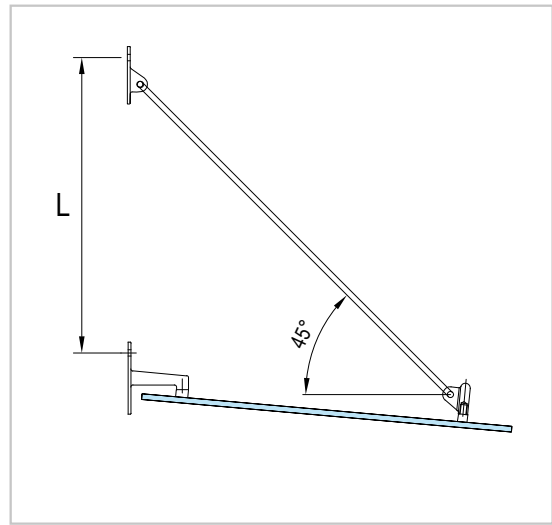

Routille con snodo
 Routille" con articulació
 Routille with pivot
 Routille mit Gelenk
 Rotule avec pivot

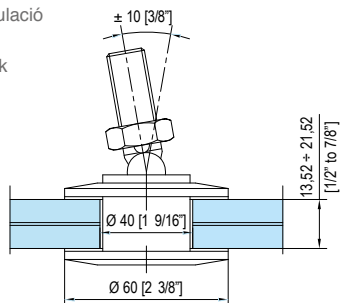

Routille senza snodo
 Routille sin articulació
 Routille senza snodo
 Routille ohne Gelenk
 Rotule sans pivot

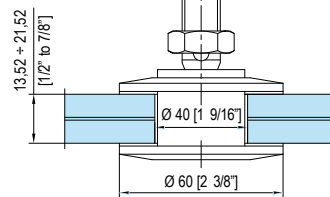

131LIGHT

- Kit pensilina standard in acciaio inox. 4 punti.
- Kit marquesina estándar en acero inox. 4 puntos de fijación.
- Stainless steel standard Canopy Kit. 4 fixing points.
- Standard Glasvordächer Kit aus Edelstahl. 4 Punkte.
- Standard Kit Marquise en inox. 4 points.

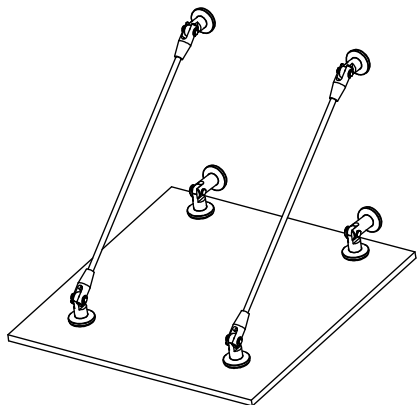

Compresso / Included



	SP SPESSORE VETRO GLASS THICKNESS		MASSIMA DIMENSIONE VETRO MAX GLASS DIMENSION
	5.5	6.6	
PA max	800	1000	1500 x 1100
PB max	700	800	
PF max	200	250	

Dimensioni - Dimensions

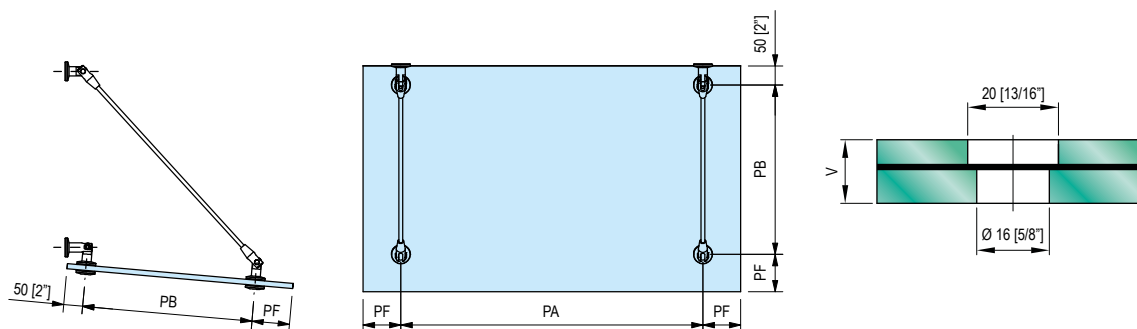

ATTACCO INFERIORE
BOTTOM BRACKET

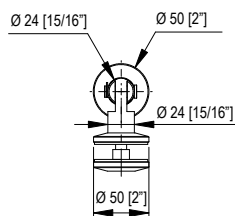

ATTACCO SUPERIORE
TOP BRACKET

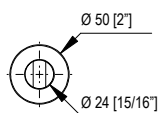

RACCORDO VETRO-TIRANTE
CONNECTION GLASS/TIE-ROD

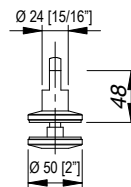

TIRANTE
TENSION ROD

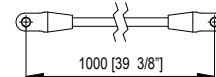

Questo è un modello standard, disponibile solo nelle dimensioni sopra indicate - Modelo estándar, disponible solo en las dimensiones indicadas en esta página
This is a standard version, only available in the above indicated dimensions - Dies ist ein Standardmodell, das nur in den oben angegebenen Abmessungen verfügbar ist - Ceci est un modèle standard, disponible uniquement dans les dimensions indiquées ci-dessus

Spiders & Rotoule

Sono disponibili Spiders e Rotoules. I sistemi proposti sono particolarmente adatti per l'involucro edilizio, per vetrate strutturali e per progetti esterni realizzati in vetro.
Il nostro ufficio commerciale è a disposizione per lo sviluppo del progetto e la quotazione.

Arañas y anclajes con rótula son disponibles. Estos sistemas son particularmente aptos para envolventes de edificio, paredes de vidrio estructurales y proyectos exteriores en los cuales se utiliza el vidrio.
Nuestra oficina comercial está a disposición para desarrollo del proyecto y cotización.

Spiders and swivel fittings are available. These systems are particularly suitable for building envelopes, structural glass walls and external projects involving glass.

Our commercial department is available for the project development and quotation.

Spiders und Rotoules sind verfügbar. Die vorgeschlagenen Systeme eignen sich besonders für die Gebäudehülle, für Structural Glazing und für externe Glasprojekte.
Unser Handelsbüro steht für die Realisierung des Projekts und des Angebots zur Verfügung.

Spiders et Rotules sont disponibles. Les systèmes proposés sont particulièrement adaptés à l'enveloppe du bâtiment, aux vitrages structurales et aux projets extérieurs réalisés en verre.
Notre bureau de ventes est disponible pour la réalisation du projet et la cotation.



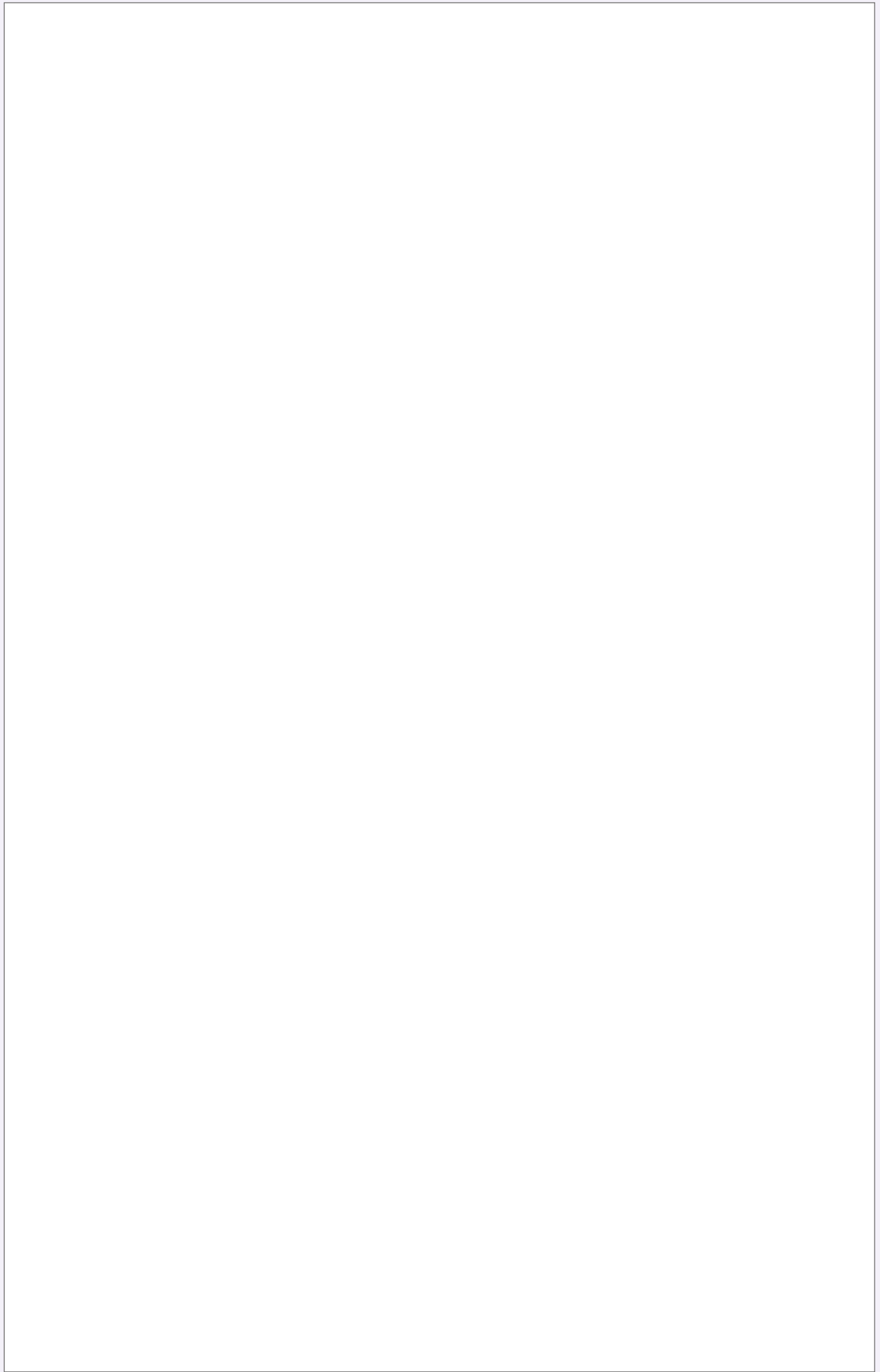

Copyright © Colcom Group Spa

L'azienda si riserva la facoltà di apportare senza preavviso modifiche dovute all'evoluzione tecnica dei prodotti.
Si consiglia di consultare l'ufficio tecnico per aggiornamenti e maggiori informazioni sulle schede tecniche specifiche.

The company reserves the right to introduce changes without notice on the basis of the technical development of the products.
We suggest to consult the technical department for updates and more information on the technical data sheets.

We Build the Invisible



Filiali e Distributori / Branches & Distributors

Nazione - Nation	Distributori Ufficiali - Official distributors
BELGIUM official branch	MINUSCO BENELUX B.V. INDUSTRIEWEG, 28 - 3133 EE VLAARDINGEN- NL Tel. +31104451069 - Web: www.minusco-benelux.com - Email: info-be@minusco-benelux.com
CANADA official branch	COLCOM GLASS HARDWARE LTD. 101 SIMONA DRIVE, UNIT 4, BOLTON, ONTARIO L7E 4E8 - CA Tel: +1 416 917 6150 - E-mail: info@colcomglasshardware.ca - Web: www.colcomglasshardware.ca
U.A.E. official distributor	GULF & MIDDLE EAST MACHINES , INDUSTRIAL AREA 17, WADI AL HELO ST. BLDG 29-PO BOX. 68561, 33108 SHARJAH - DUBAI, AE Tel: +971 65352512 - E-mail: sales.dept@gmem.me - Web: www.gmem.me
FRANCE official branch	COLCOM - SADEV SB INGENIERIE ARCHITECTURAL GLASS SYSTEMS 76, CHEMIN DE POSES BP 18 74330 POISY (ANNECY) - FR Tel. +33450083900 - Web: www.sadev.com - E-mail: info@minusco.fr
GERMANY official branch	COLCOM SADEV DEUTSCHLAND - VIA DEGLI ARTIGIANI, 56 INT.1 - 25075 NAVE (BRESCIA) - ITALIA Tel. (+49) 2157 870 42 10 - Fax (+49) 171 7524400 - E-mail: luigi.rosati@colcomgroup.it - Web: www.colcomsadev.de
JAPAN official distributor	SUGATSUNE KOGYO CO. LTD - 2-17-9 IWAMOTOCHO, CHIYODA-KU 101-0032 - TOKYO - JAPAN Tel: +81-3-3866-2260 - Fax +81-3-3866-4447 - Web: www.sugatsune.co.jp - E-mail: export@sugatsune.co.jp
HOLLAND official branch	MINUSCO BENELUX B.V. INDUSTRIEWEG, 28 - 3133 EE VLAARDINGEN- NL Tel. +31104451069 - Web: www.minusco-benelux.com - Email: info-nl@minusco-benelux.com
ITALY official branch	Brescia COLCOM GROUP S.p.A. - VIA DEGLI ARTIGIANI, 52 INT.1 - 25075 NAVE (BRESCIA) - ITALIA Tel. (+39)0302532008 - Fax (+39)0302534707 - E-mail : info@colcomgroup.it
ITALY official branch	Bologna COLCOM GROUP S.p.A. Tel. (+39)0516720212 - Fax (+39)051969877 - E-mail : bologna@colcomgroup.it
ITALY official branch	Roma COLCOM GROUP S.p.A. Tel. (+39)067827339 - Fax. (+39)067880463 - E-mail : inforoma@colcomgroup.it
ITALY official distributor	COLCOM SADEV SUD - VIA VOLPICELLA, 240 - 80147 NAPOLI - ITALIA Tel. (+39)0815720167 - Fax (+39)0815720258 - E-mail : minuscosud@t3glass.com
LEBANON official distributor	MIDDLE EAST BUSINESS GROUP FOR IMPORT & EXPORT , JISR EL BACHA STREET - BOULOS BLDG - PO BOX 45, 45422 HAZMIEH - BEIRUT, LB Tel: +961 1 511081 - E-mail: sales@gmebusiness.com - Web: www.gmebusiness.com
LUXEMBOURG official branch	MINUSCO BENELUX B.V. INDUSTRIEWEG, 28 - 3133 EE VLAARDINGEN- NL Tel. +31104451069 - Web: www.minusco-benelux.com - Email: info@minusco-benelux.com
PORTUGAL official branch	COLCOM SADEV IBERICA FORMENTERA 38 BAJOS.BARRIO DEL PONT MAJOR GIRONA-17007- ES Tel. +34972203138 - E-mail: info@minuscoib.com
RUSSIA official distributor	GLASS FURNITURA , SMOLENKA EMB. H. 5/7, OFFICE 415, 199178 ST. PETERSBURG, RU Tel: +7 812 456 456 0 - E-mail: order@glassfurniture.ru - Web: www.glassfurniture.ru
SLOVENIA official distributor	M SORA D.D. TRG SVOBODE 2 - 4226 - ZIRI - SLOVENIA Tel. +38 645304100 - Fax +38 645314873 - Web: www.m-sora.si - E-mail: info@m-sora.si
SPAIN official branch	COLCOM SADEV IBERICA FORMENTERA 38 BAJOS.BARRIO DEL PONT MAJOR GIRONA-17007- ES Tel. +34972203138 - E-mail: info@minuscoib.com
SWITZERLAND official distributor	FONSEGRIVE GmbH MOOSMATTSTRASSE, 14- 4304 GIEBENACH - BL - CH Tel. +41 61 816 20 00 - Web: www.fonsegrive.ch - E-mail: einkauf@fonsegrive.ch
TURKEY official branch	BM CAM DONANIMLARI SAN. VE TIC. LTD. STI - AHMET YESEVI MH. DEMOKRASI - CAD. NO:127/2 - 34930 - SULTANBEYLI - ISTANBUL TURCHIA Tel: +90 216 498 80 51 - Fax +90 216 498 80 52 - E-mail: meltem.sahin@bmfosis.com - Web: www.bmfosis.com

HEAD OFFICE CONTACTS Italy : info@colcomgroup.it Other countries : export@colcomgroup.it